

GROUP 11 WORK EQUIPMENT

1. STRUCTURE

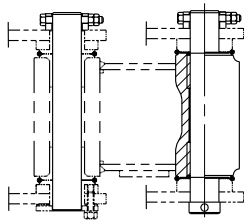

SECTION A

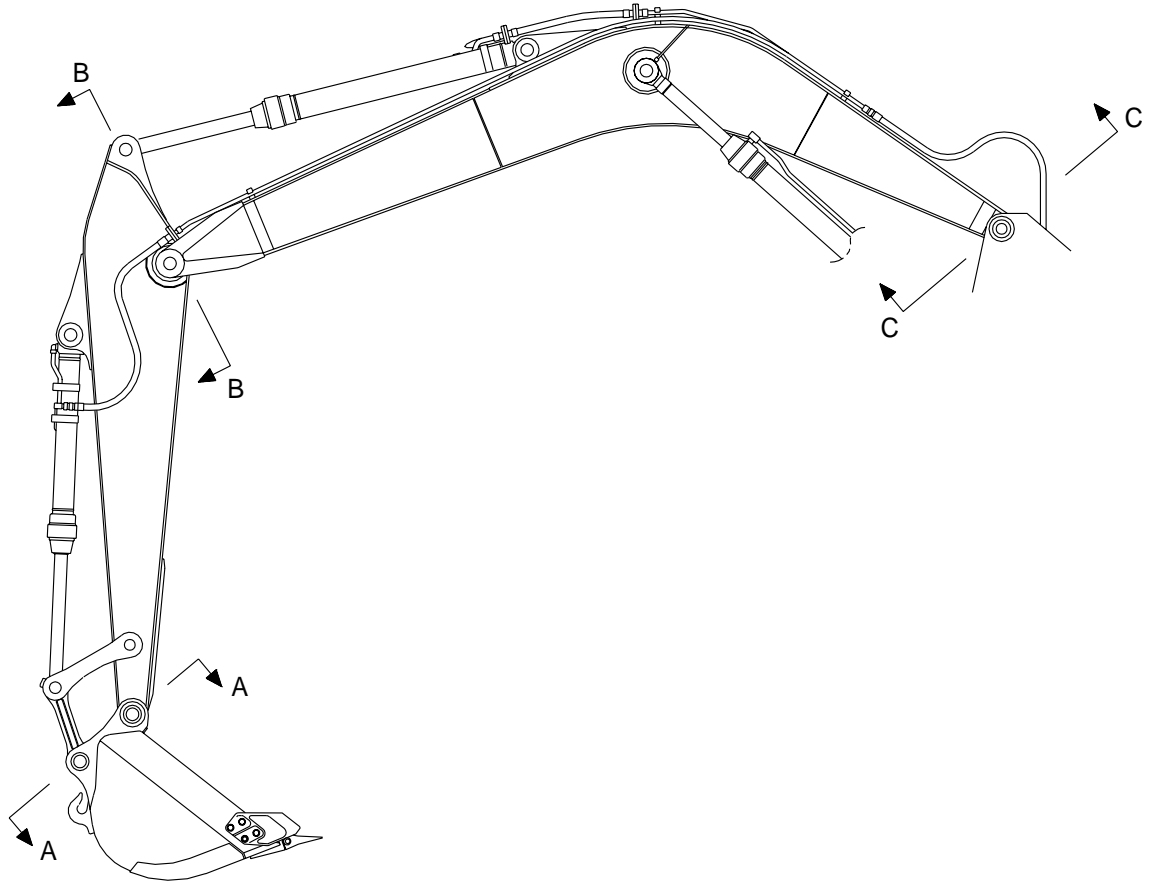
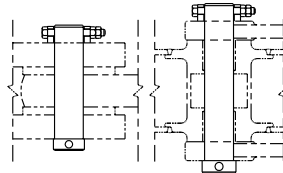

SECTION B

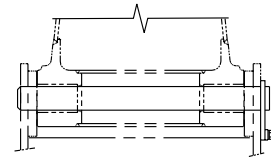

SECTION C

2. REMOVAL AND INSTALL

1) BUCKET ASSEMBLY

(1) Removal

- ① Lower the work equipment completely to ground with back of bucket facing down.

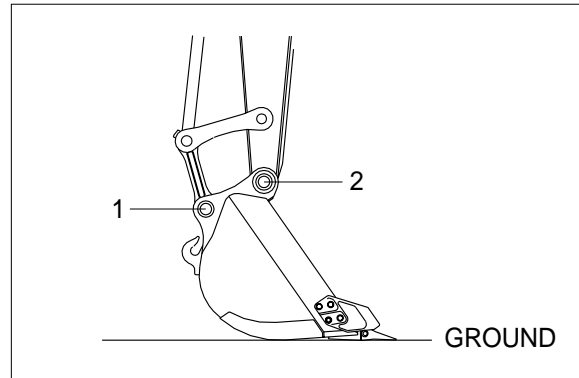

- ② Remove nut(4), bolt(3), and draw out the pin(1).

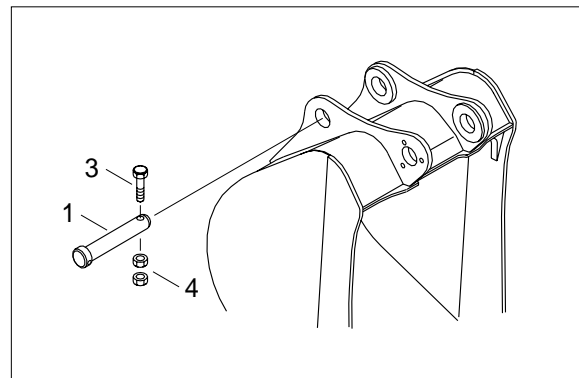

- ③ Remove nut(4), bolt(3), and draw out the pin(2).

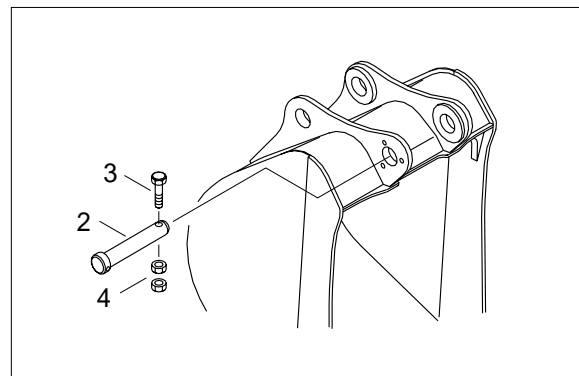

(2) Install

- ① Carry out installation in the reverse order to removal.
- ▲ When aligning the mounting position of the pin, do not insert your fingers in the pin hole.
- ※ Adjust the bucket clearance.
For detail, see **operation manual**.

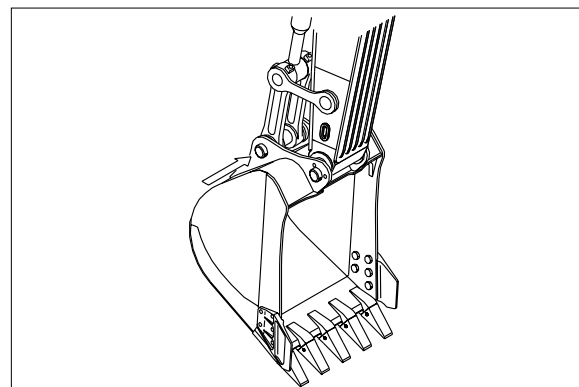

2) ARM ASSEMBLY

(1) Removal

- ※ Operate the control levers and pedals several times to release the remaining pressure in the hydraulic piping.
- ※ Loosen the breather slowly to release the pressure inside the hydraulic tank.
- ▲ Escaping fluid under pressure can penetrate the skin causing serious injury.

① Remove bucket assembly.

For details, see **removal of bucket assembly**.

② Loosen socket bolt(2) to disconnect bucket cylinder hoses(1).

- ▲ Fit blind plugs in the piping at the chassis end securely to prevent oil from spurting out when the engine is started.

③ Sling arm cylinder assembly, and remove nut, bolt, then pull out pin.

- ※ Tie the rod with wire to prevent it from coming out.

For details, see **removal of arm cylinder assembly**.

④ Place a wooden block under the cylinder and bring the cylinder down to it.

⑤ Remove nut(5), bolt(4) and pull out the pin(3) then remove the arm assembly.

· Weight : 820kg(1808lb)

- ※ When lifting the arm assembly, always lift the center of gravity.

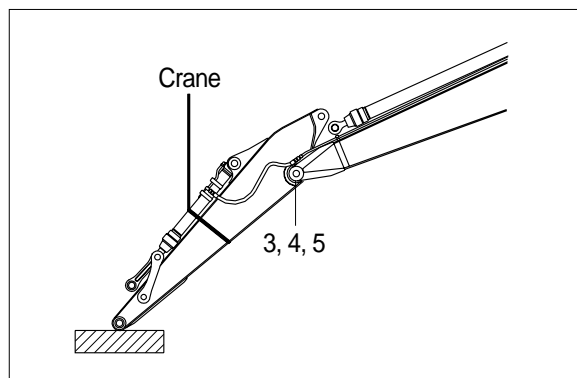
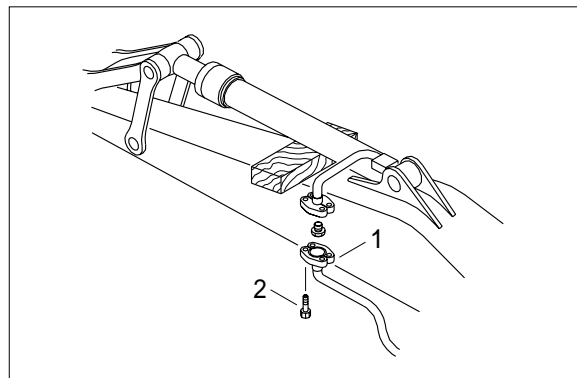
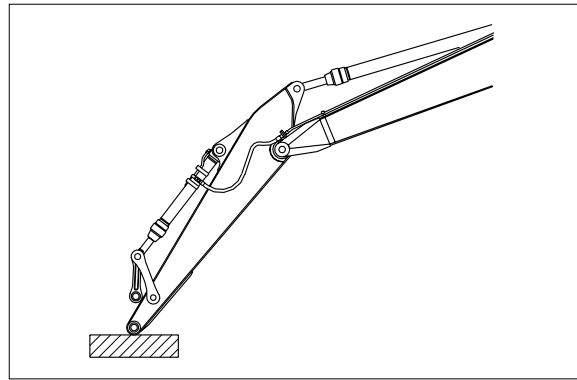

(2) Install

① Carry out installation in the reverse order to removal.

- ▲ When lifting the arm assembly, always lift the center of gravity.

- ※ Bleed the air from the cylinder.

3) BOOM ASSEMBLY

(1) Removal

- ① Remove arm and bucket assembly.
For details, see **removal of arm and bucket assembly**.
- ② Remove boom cylinder assembly from boom.
For details, see **removal of boom cylinder assembly**.

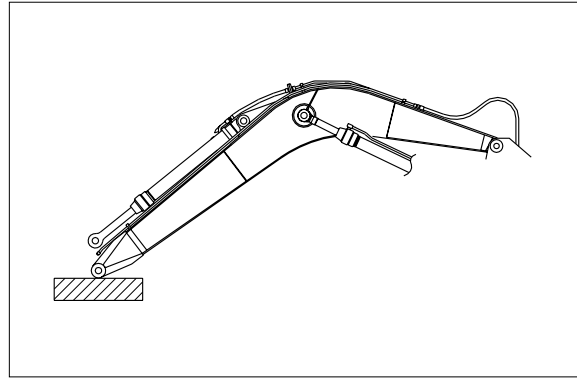

- ③ Disconnect head work wiring.
 - ④ Disconnect bucket cylinder hose(2) and arm cylinder hose(1).
- ※ When the hoses are disconnected, oil may spurt out.

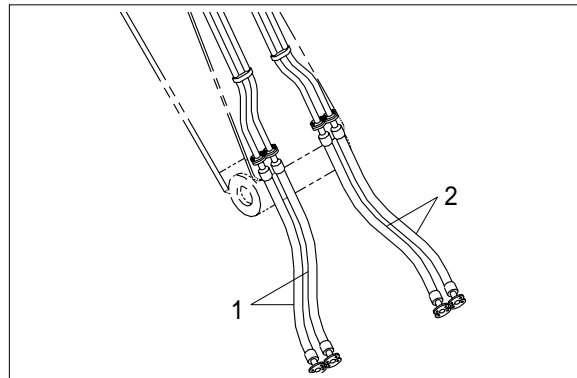

- ⑤ Sling boom assembly(3).
 - ⑥ Remove bolt(4), nut(5) and pull out the pin(6) then remove boom assembly.
· Weight :1354kg(2985lb)
- ※ When lifting the boom assembly always lift the center of gravity.

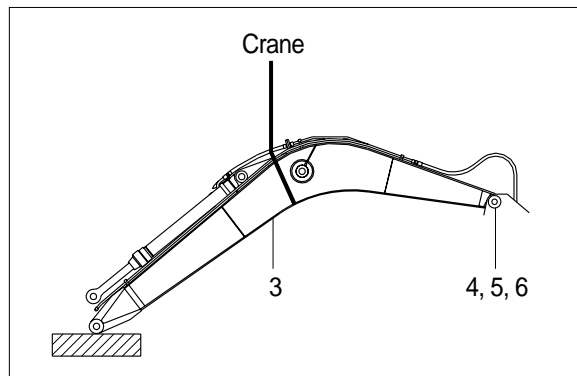

(2) Install

- ① Carry out installation in the reverse order to removal.
- ▲ When lifting the boom assembly, always lift the center of gravity.
- ※ Bleed the air from the cylinder.

