

SECTION 1 GENERAL

Group 1 Safety Hints	1-1
Group 2 Specifications	1-9

SECTION 2 STRUCTURE AND FUNCTION

Group 1 Pump Device	2-1
Group 2 Main Control Valve	2-6
Group 3 Swing Device	2-35
Group 4 Travel Device	2-46
Group 5 RCV Lever	2-56
Group 6 RCV Pedal	2-65

SECTION 3 HYDRAULIC SYSTEM

Group 1 Hydraulic Circuit	3-1
Group 2 Main Circuit	3-3
Group 3 Pilot Circuit	3-6
Group 4 Single Operation	3-11
Group 5 Combined Operation	3-23

SECTION 4 ELECTRICAL SYSTEM

Group 1 Component Location	4-1
Group 2 Monitoring system	4-3
Group 3 Electrical Circuit	4-7
Group 4 Electrical Component Specification	4-19
Group 5 Connectors	4-24

SECTION 5 TROUBLESHOOTING

Group 1 Before Troubleshooting	5-1
Group 2 Hydraulic and Mechanical System	5-4
Group 3 Electrical System	5-24

SECTION 6 MAINTENANCE STANDARD

Group 1 Operational Performance Test	6-1
Group 2 Major Components	6-20
Group 3 Track and Work Equipment	6-30

SECTION 7 DISASSEMBLY AND ASSEMBLY

Group 1 Precaution	7-1
Group 2 Tightening Torque	7-4
Group 3 Pump Device	7-7
Group 4 Main Control Valve	7-20
Group 5 Swing Device	7-44
Group 6 Travel Device	7-69
Group 7 RCV Lever	7-99
Group 8 Turning Joint	7-115
Group 9 Boom, Arm and Bucket Cylinder	7-120
Group 10 Undercarriage	7-140
Group 11 Work Equipment	7-151

SECTION 1 GENERAL

Group 1 Safety Hints	1-1
Group 2 Specifications	1-9

SECTION 1 GENERAL

GROUP 1 SAFETY

FOLLOW SAFE PROCEDURE

Unsafe work practices are dangerous. Understand service procedure before doing work; Do not attempt shortcuts.

WEAR PROTECTIVE CLOTHING

Wear close fitting clothing and safety equipment appropriate to the job.

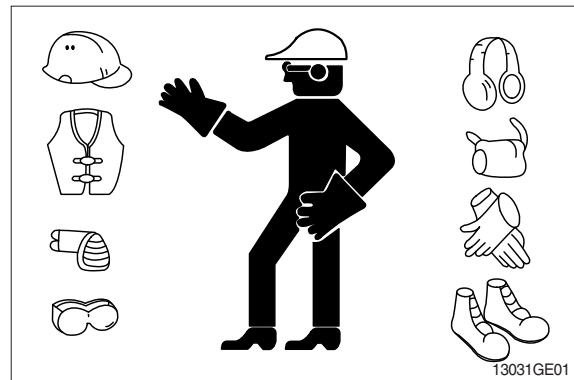

WARN OTHERS OF SERVICE WORK

Unexpected machine movement can cause serious injury. Before performing any work on the excavator, attach a 「Do Not Operate」 tag on the right side control lever.

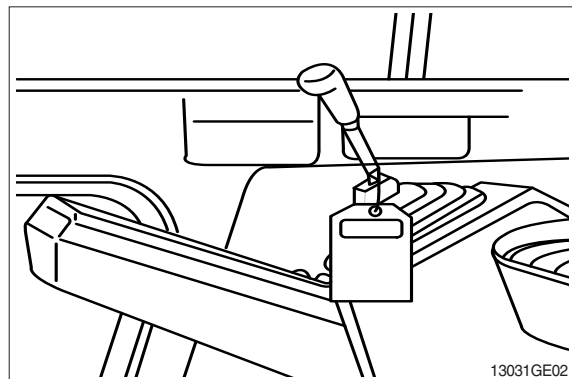

USE HANDHOLDS AND STEPS

Falling is one of the major causes of personal injury. When you get on and off the machine, always maintain a three point contact with the steps and handrails and face the machine. Do not use any controls as handholds. Never jump on or off the machine. Never mount or dismount a moving machine. Be careful of slippery conditions on platforms, steps, and handrails when leaving the machine.

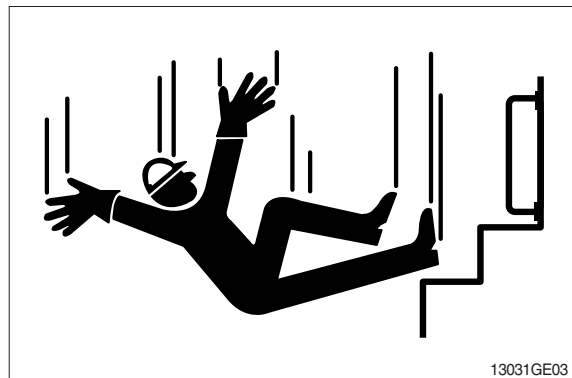

PREPARE FOR EMERGENCIES

Be prepared if a fire starts.

Keep a first aid kit and fire extinguisher handy.

Keep emergency numbers for doctors, ambulance service, hospital, and fire department near your telephone.

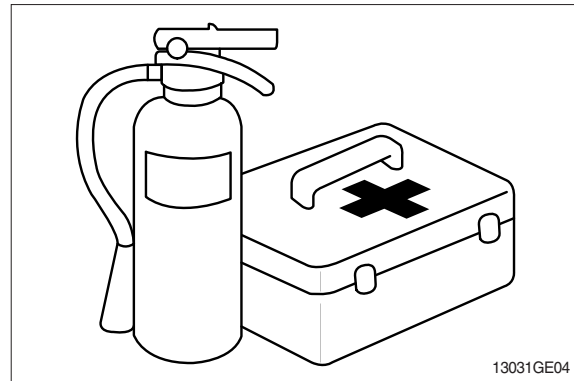

PROTECT AGAINST FLYING DEBRIS

Guard against injury from flying pieces of metal or debris; Wear goggles or safety glasses.

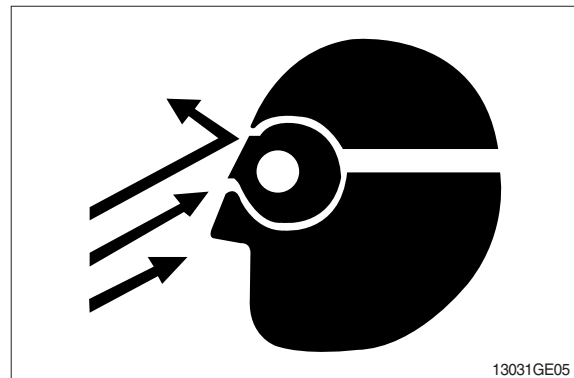

PROTECT AGAINST NOISE

Prolonged exposure to loud noise can cause impairment or loss of hearing.

Wear a suitable hearing protective device such as earmuffs or earplugs to protect against objectionable or uncomfortable loud noises.

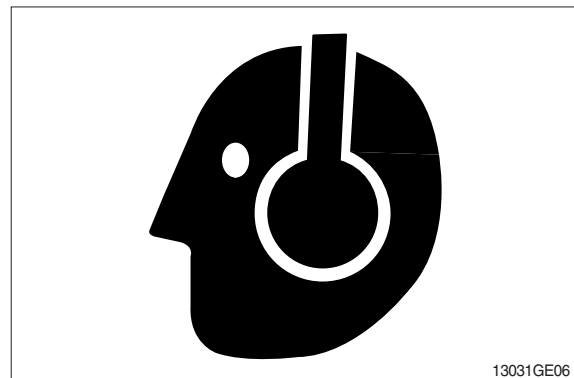

AVOID POWER LINES

Serious injury or death can result from contact with electric lines.

Never move any part of the machine or load closer to electric line than 3m(10ft) plus twice the line insulator length.

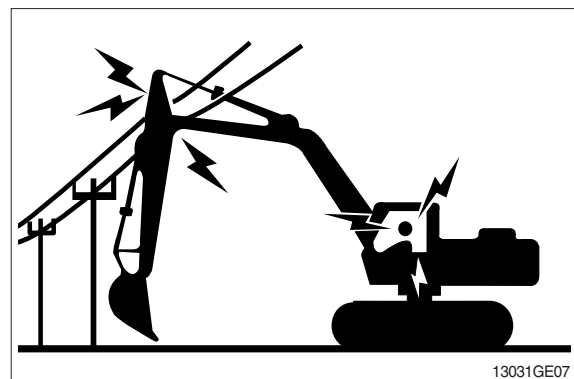

KEEP RIDERS OFF EXCAVATOR

Only allow the operator on the excavator. Keep riders off.

Riders on excavator are subject to injury such as being struck by foreign objects and being thrown off the excavator. Riders also obstruct the operator's view resulting in the excavator being operated in an unsafe manner.

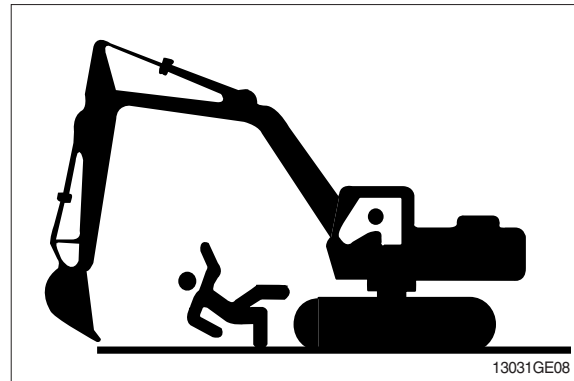

MOVE AND OPERATE MACHINE SAFELY

Bystanders can be run over. Know the location of bystanders before moving, swinging, or operating the machine.

Always keep the travel alarm in working condition. It warns people when the excavator starts to move.

Use a signal person when moving, swinging, or operating the machine in congested areas. Coordinate hand signals before starting the excavator.

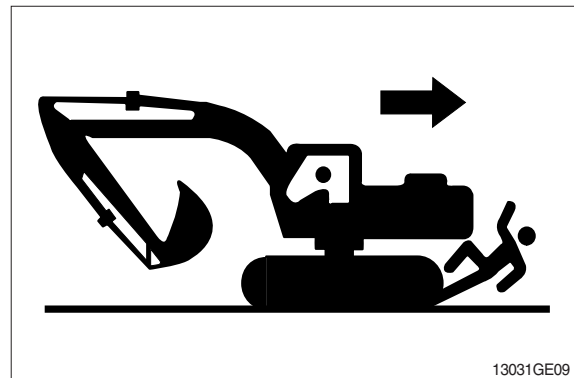

OPERATE ONLY FROM OPERATOR'S SEAT

Avoid possible injury machine damage. Do not start engine by shorting across starter terminals.

NEVER start engine while standing on ground. Start engine only from operator's seat.



PARK MACHINE SAFELY

Before working on the machine:

- Park machine on a level surface.
- Lower bucket to the ground.
- Turn auto idle switch off.
- Run engine at 1/2 speed without load for 2 minutes.
- Turn key switch to OFF to stop engine.
Remove key from switch.
- Move pilot control shutoff lever to locked position.
- Allow engine to cool.

SUPPORT MACHINE PROPERLY

Always lower the attachment or implement to the ground before you work on the machine. If you must work on a lifted machine or attachment, securely support the machine or attachment.

Do not support the machine on cinder blocks, hollow tiles, or props that may crumble under continuous load.

Do not work under a machine that is supported solely by a jack. Follow recommended procedures in this manual.

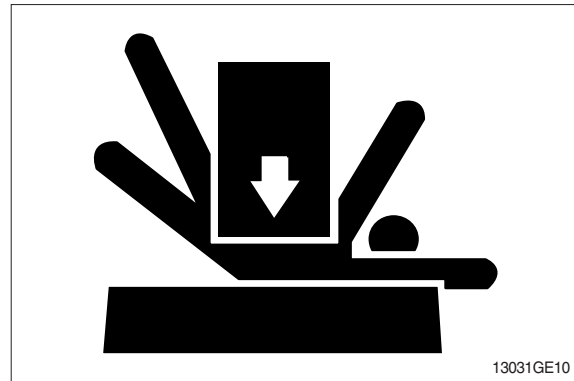

SERVICE COOLING SYSTEM SAFELY

Explosive release of fluids from pressurized cooling system can cause serious burns.

Shut off engine. Only remove filler cap when cool enough to touch with bare hands.

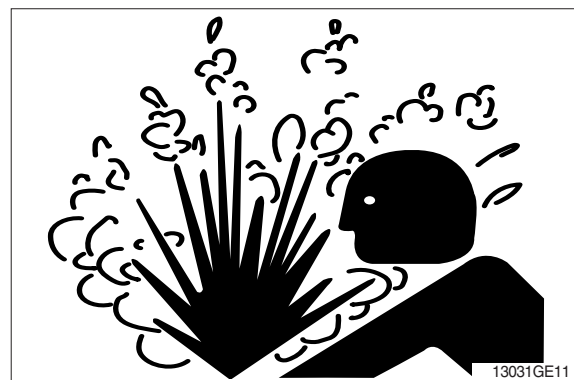

HANDLE FLUIDS SAFELY-AVOID FIRES

Handle fuel with care; It is highly flammable. Do not refuel the machine while smoking or when near open flame or sparks. Always stop engine before refueling machine.

Fill fuel tank outdoors.

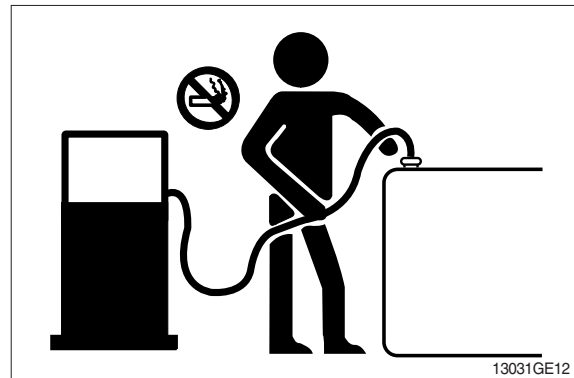

Store flammable fluids away from fire hazards. Do not incinerate or puncture pressurized containers.

Make sure machine is clean of trash, grease, and debris.

Do not store oily rags; They can ignite and burn spontaneously.



BEWARE OF EXHAUST FUMES

Prevent asphyxiation. Engine exhaust fumes can cause sickness or death.

If you must operate in a building, be positive there is adequate ventilation. Either use an exhaust pipe extension to remove the exhaust fumes or open doors and windows to bring enough outside air into the area.

REMOVE PAINT BEFORE WELDING OR HEATING

Avoid potentially toxic fumes and dust.

Hazardous fumes can be generated when paint is heated by welding, soldering, or using a torch.

Do all work outside or in a well ventilated area. Dispose of paint and solvent properly.

Remove paint before welding or heating:

- If you sand or grind paint, avoid breathing the dust. Wear an approved respirator.
- If you use solvent or paint stripper, remove stripper with soap and water before welding. Remove solvent or paint stripper containers and other flammable material from area. Allow fumes to disperse at least 15 minutes before welding or heating.

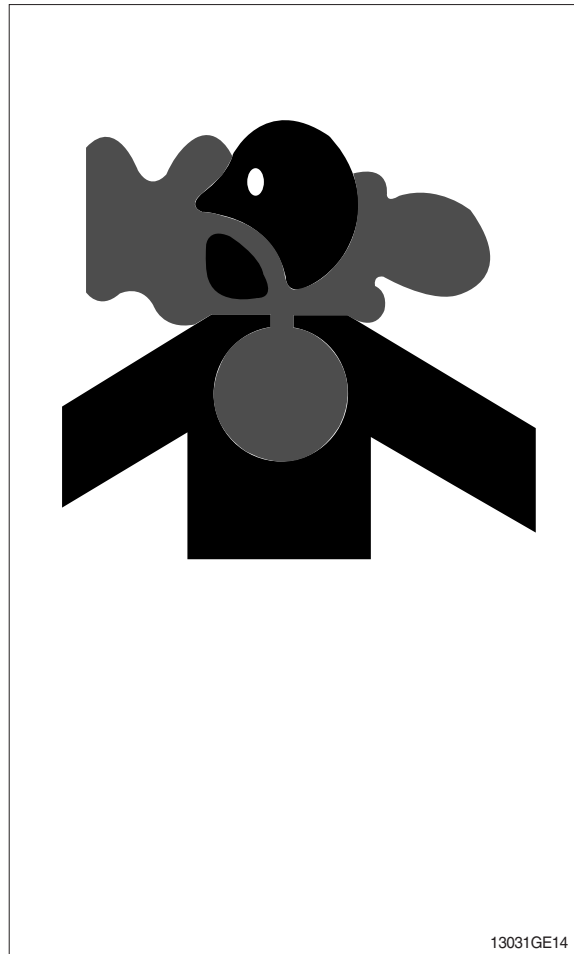

ILLUMINATE WORK AREA SAFELY

Illuminate your work area adequately but safely. Use a portable safety light for working inside or under the machine. Make sure the bulb is enclosed by a wire cage. The hot filament of an accidentally broken bulb can ignite spilled fuel or oil.



SERVICE MACHINE SAFELY

Tie long hair behind your head. Do not wear a necktie, scarf, loose clothing or necklace when you work near machine tools or moving parts. If these items were to get caught, severe injury could result.

Remove rings and other jewelry to prevent electrical shorts and entanglement in moving parts.

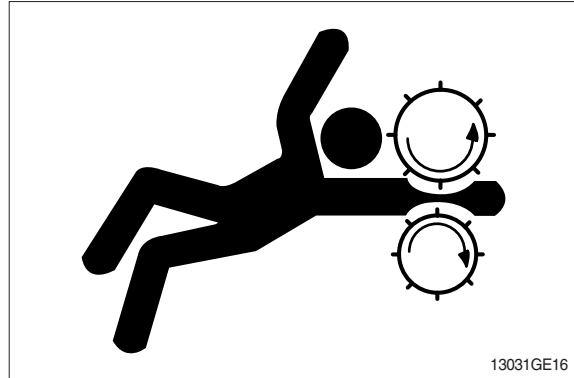

STAY CLEAR OF MOVING PARTS

Entanglements in moving parts can cause serious injury.

To prevent accidents, use care when working around rotating parts.

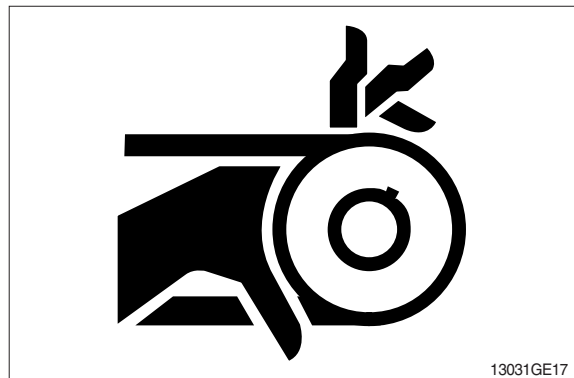

AVOID HIGH PRESSURE FLUIDS

Escaping fluid under pressure can penetrate the skin causing serious injury.

Avoid the hazard by relieving pressure before disconnecting hydraulic or other lines. Tighten all connections before applying pressure.

Search for leaks with a piece of cardboard. Protect hands and body from high pressure fluids.

If an accident occurs, see a doctor immediately. Any fluid injected into the skin must be surgically removed within a few hours or gangrene may result.

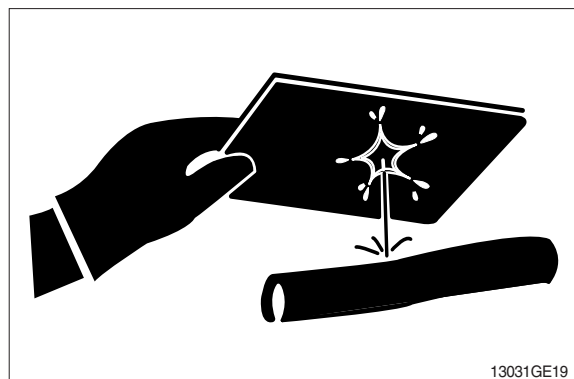

AVOID HEATING NEAR PRESSURIZED FLUID LINES

Flammable spray can be generated by heating near pressurized fluid lines, resulting in severe burns to yourself and bystanders. Do not heat by welding, soldering, or using a torch near pressurized fluid lines or other flammable materials.

Pressurized lines can be accidentally cut when heat goes beyond the immediate flame area. Install fire resisting guards to protect hoses or other materials.



PREVENT BATTERY EXPLOSIONS

Keep sparks, lighted matches, and flame away from the top of battery. Battery gas can explode.

Never check battery charge by placing a metal object across the posts. Use a volt-meter or hydrometer.

Do not charge a frozen battery; It may explode. Warm battery to 16°C (60°F).



PREVENT ACID BURNS

Sulfuric acid in battery electrolyte is poisonous. It is strong enough to burn skin, eat holes in clothing, and cause blindness if splashed into eyes.

Avoid the hazard by:

1. Filling batteries in a well-ventilated area.
2. Wearing eye protection and rubber gloves.
3. Avoiding breathing fumes when electrolyte is added.
4. Avoiding spilling or dripping electrolyte.
5. Use proper jump start procedure.

If you spill acid on yourself:

1. Flush your skin with water.
2. Apply baking soda or lime to help neutralize the acid.
3. Flush your eyes with water for 10-15 minutes. Get medical attention immediately.

If acid is swallowed:

1. Drink large amounts of water or milk.
2. Then drink milk of magnesia, beaten eggs, or vegetable oil.
3. Get medical attention immediately.

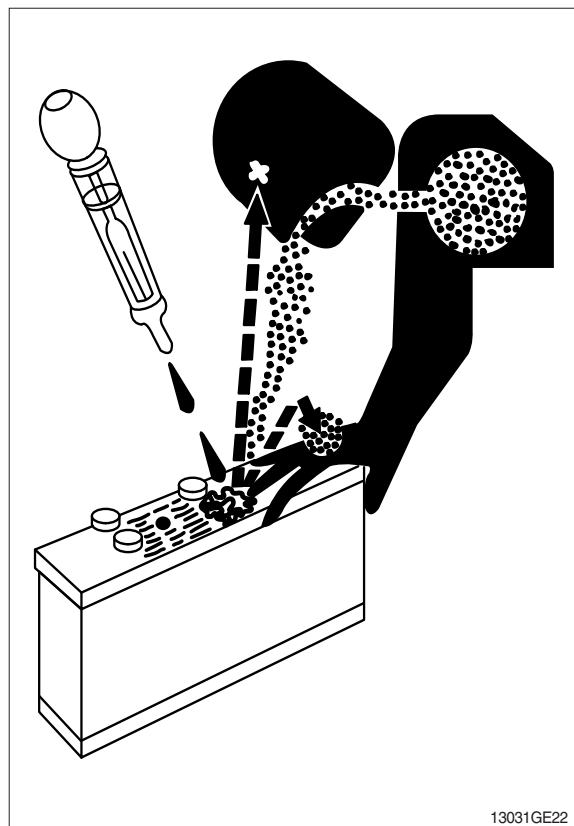

USE TOOLS PROPERLY

Use tools appropriate to the work. Makeshift tools, parts, and procedures can create safety hazards.

Use power tools only to loosen threaded tools and fasteners.

For loosening and tightening hardware, use the correct size tools. DO NOT use U.S. measurement tools on metric fasteners. Avoid bodily injury caused by slipping wrenches.

Use only recommended replacement parts. (See Parts catalogue.)

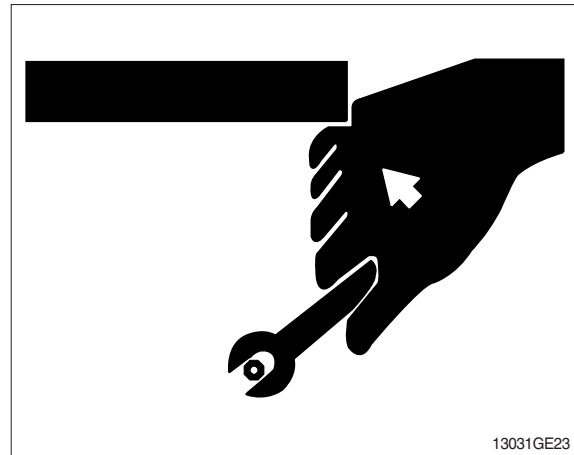

DISPOSE OF FLUIDS PROPERLY

Improperly disposing of fluids can harm the environment and ecology. Before draining any fluids, find out the proper way to dispose of waste from your local environmental agency.

Use proper containers when draining fluids. Do not use food or beverage containers that may mislead someone into drinking from them.

DO NOT pour oil into the ground, down a drain, or into a stream, pond, or lake. Observe relevant environmental protection regulations when disposing of oil, fuel, coolant, brake fluid, filters, batteries, and other harmful waste.

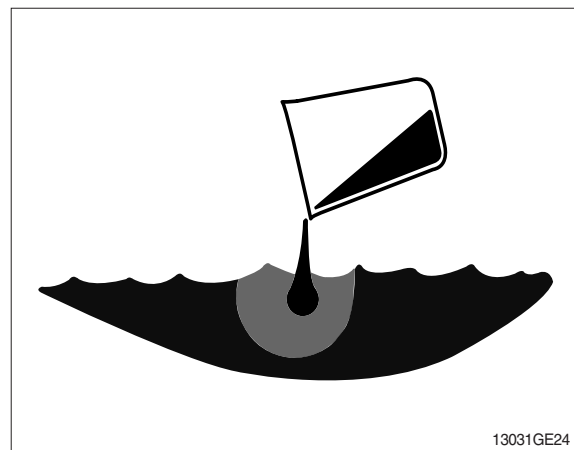

REPLACE SAFETY SIGNS

Replace missing or damaged safety signs. See the machine operator's manual for correct safety sign placement.

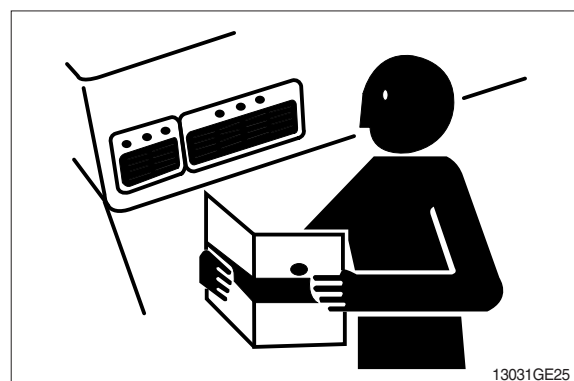

LIVE WITH SAFETY

Before returning machine to customer, make sure machine is functioning properly, especially the safety systems. Install all guards and shields.

GROUP 2 SPECIFICATIONS

1. MAJOR COMPONENT

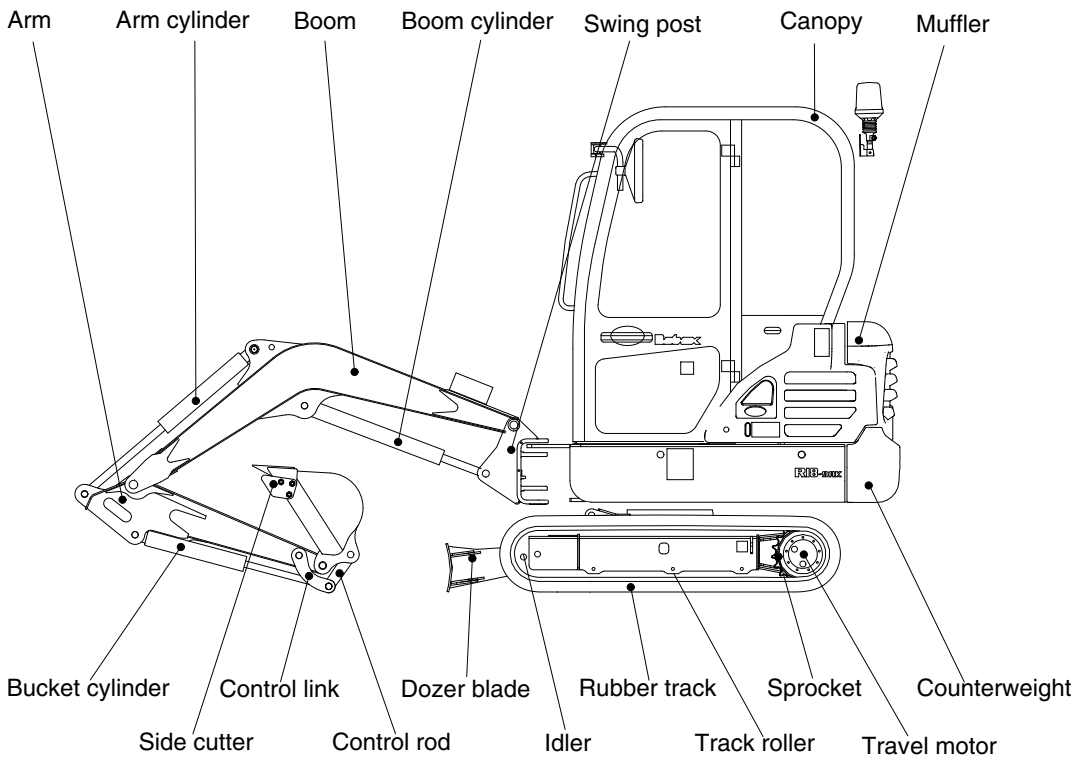
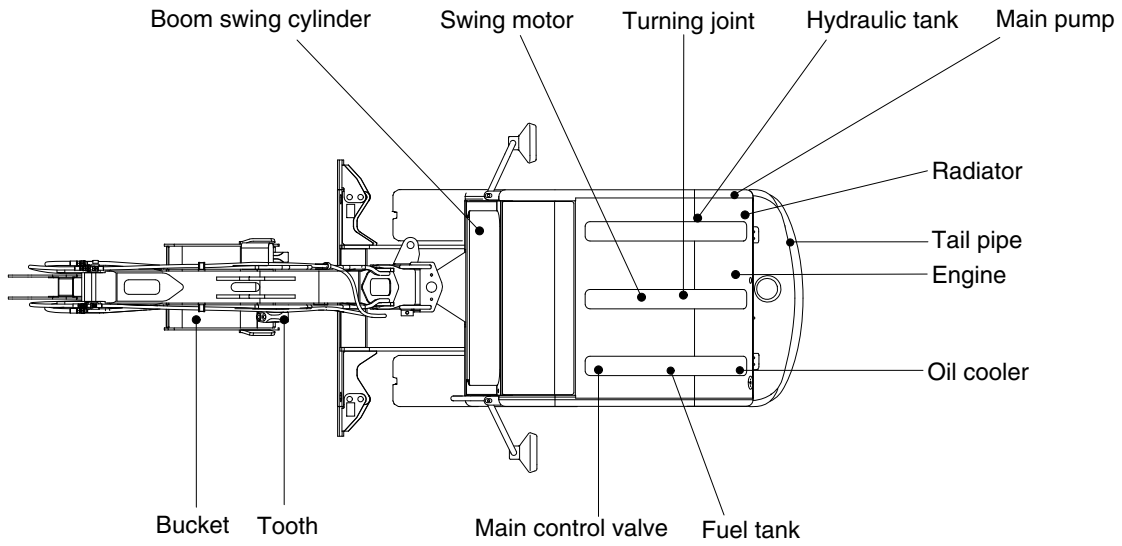

18AK2SP01

2. SPECIFICATIONS

1) 1.80 m (5' 11") MONO BOOM, 0.96 m (3' 2") ARM, WITH BOOM SWING POST

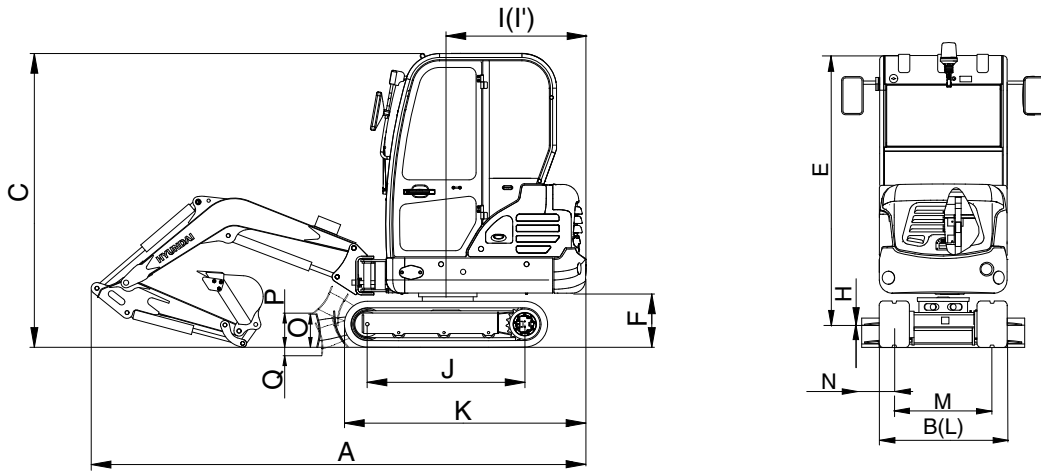

18AK2SP02

Description		Unit	Specification
Operating weight (canopy/cabin)		kg (lb)	1855 (4089) / 1995 (4398)
Bucket capacity (SAE heaped), standard		m ³ (yd ³)	0.04 (0.05)
Overall length	A	mm (ft-in)	3860 (12' 8")
Overall width, with 230 mm shoe (extension crawler)	B		980~1270 (3' 3" ~ 4' 2")
Overall height	C		2300 (7' 7")
Overall height of canopy/cabin	E		2300 (7' 7")
Ground clearance of counterweight	F		415 (1' 4")
Minimum ground clearance	H		150 (0' 6")
Rear-end distance	I		1065 (3' 6")
Rear-end swing radius	I'		1065 (3' 6")
Distance between tumbler rollers	J		1230 (4' 0")
Undercarriage length	K		1590 (5' 3")
Undercarriage width (extension crawler)	L		980~1270 (3' 3" ~ 4' 2")
Track gauge (extension crawler)	M		750~1040 (2' 6" ~ 3' 5")
Track shoe width, standard	N		230 (9")
Height of blade	O		250 (0' 10")
Ground clearance of blade up	P		170 (0' 7")
Depth of blade down	Q		240 (0' 9")
Travel speed (low/high)			km/hr (mph)
Swing speed		rpm	9.1
Gradeability		Degree (%)	30 (58)
Ground pressure 230 mm rubber shoe (canopy/cabin)		kgf/cm ² (psi)	0.3 (4.24) / 0.32 (4.56)
Max traction force		kg (lb)	1420 (3131)

3. WORKING RANGE

1) 1.80 m (5' 11") MONO BOOM WITH BOOM SWING POST

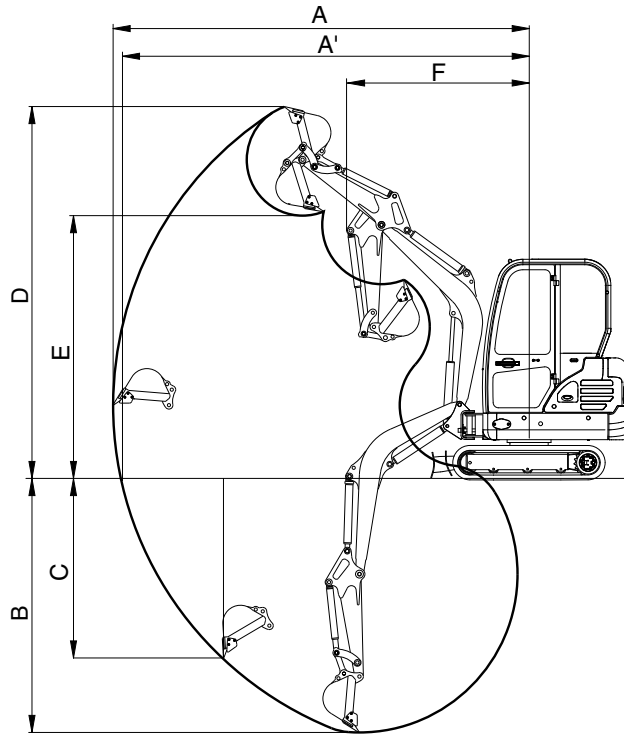

18AK2SP03



Description		0.96 m (3' 2") Arm
Max digging reach	A	3960 mm (12' 12")
Max digging reach on ground	A'	3870 mm (12' 8")
Max digging depth	B	2245 mm (7' 4")
Max vertical wall digging depth	C	1775 mm (5' 10")
Max digging height	D	3675 mm (12' 1")
Max dumping height	E	2575 mm (8' 5")
Min swing radius	F	1660 mm (5' 5")
Boom swing radius (left/right)		60°/60°
Bucket digging force	SAE	13.1 kN
		1340 kgf
		2950 lbf
	ISO	15.1 kN
		1540 kgf
		3400 lbf
Arm crowd force	SAE	9.0 kN
		920 kgf
		2030 lbf
	ISO	9.4 kN
		960 kgf
		2120 lbf

4. WEIGHT







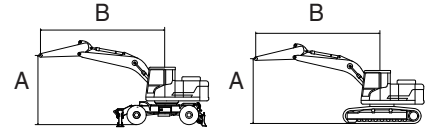

Item	kg	lb
Upperstructure assembly	940	2070
Main frame weld assembly	225	510
Engine assembly	80	176
Main pump assembly	13	29
Main control valve assembly	25	55
Swing motor assembly	23	50
Hydraulic oil tank assembly	20	44
Fuel tank assembly	18	40
Boom swing post	35	80
Counterweight	65	130
Canopy assembly	47	104
Front guard	12	26
Lower chassis assembly	530	1170
Track frame weld assembly	150	330
Swing bearing	20	44
Travel motor assembly	18	40
Turning joint	20	44
Track recoil spring	11	24
Idler	15	33
Track roller	5	11
Sprocket	4	9
Rubber track (230 mm)	71	156
Dozer blade assembly	60	130
Front attachment assembly (1.8 m boom, 0.96 m arm, 0.04 m ³ SAE heaped bucket)	200	440
1.8 m boom assembly	70	154
0.96 m arm assembly	37	82
0.04 m ³ SAE heaped bucket	43	95
Boom cylinder assembly	17	37
Arm cylinder assembly	15	33
Bucket cylinder assembly	11	24
Bucket control link assembly	10	22
Dozer cylinder assembly	11	24
Boom swing cylinder assembly	11	24
Extension cylinder assembly	8	18

5. LIFTING CAPACITIES

Model	Type	Boom	Arm	Counterweight	Shoe	Wheel	Dozer		Outrigger	
R18-9AK	Canopy	Length [mm]	Length [mm]	weight [kg]	width [mm]	width [mm]	Front	Rear	Front	Rear
		1800	960	60	230	-	Down	-	-	-

 : Rating over-front
  : Rating over-side or 360 degree



Lift-point height (A)		Lift-point radius (B)						At max. reach		
		2.0 m (6.6 ft)		2.5 m (8.2 ft)		3.0 m (9.8 ft)		Capacity		Reach
										m (ft)
3.0 m (9.8 ft)	kg lb							*400 *880	*400 *880	2.20 (7.2)
2.5 m (8.2 ft)	kg lb			*370 *820	*370 *820			*340 *750	320 710	2.76 (9.1)
2.0 m (6.6 ft)	kg lb			*390 *860	380 840	*390 *860	280 620	*310 *680	270 600	3.10 (10.2)
1.5 m (4.9 ft)	kg lb	*530 *1170	520 1150	*450 *990	370 820	*410 *900	280 620	*310 *680	240 530	3.30 (10.8)
1.0 m (3.3 ft)	kg lb	*730 *1610	490 1080	*530 *1170	360 790	*450 *990	270 600	*320 *710	230 510	3.39 (11.1)
0.5 m (1.6 ft)	kg lb	*870 *1920	470 1040	*610 *1340	350 770	*480 *1060	270 600	*340 *750	220 490	3.39 (11.1)
Ground Line	kg lb	*910 *2010	470 1040	*650 *1430	340 750	*500 *1100	260 570	*390 *860	230 510	3.29 (10.8)
-0.5 m (-1.6 ft)	kg lb	*880 *1940	470 1040	*630 *1390	340 750	*480 *1060	260 570	*450 *990	250 550	3.08 (10.1)
-1.0 m (-3.3 ft)	kg lb	*770 *1700	470 1040	*550 *1210	340 750			*460 *1010	300 660	2.74 (9.0)
-1.5 m (-4.9 ft)	kg lb	*520 *1150	480 1060					*440 *970	430 950	2.15 (7.1)

Note 1. Lifting capacity are based on ISO 10567.

2. Lifting capacity of the R18-9AK series does not exceed 75% of tipping load with the machine on firm, level ground or 87% of full hydraulic capacity.

3. The lift-point is bucket pivot mounting pin on the arm (without bucket mass).

4. *Indicates load limited by hydraulic capacity.

※ Lifting capacities are based upon a standard machine conditions.

Lifting capacities will vary with different work tools, ground conditions and attachments.

The difference between the weight of a work tool attachment must be subtracted.



Consult your Hyundai dealer regarding the lifting capacities for specific work tools and attachments.

※ Please be aware of the local regulations and instructions for lifting operations.







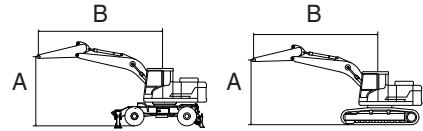

▲ Failure to comply to the rated load can cause possible personal injury or property damage.

Make adjustments to the rated load as necessary for non-standard configurations.

Model	Type	Boom	Arm	Counterweight	Shoe	Wheel	Dozer		Outrigger	
R18-9AK	Canopy	Length [mm]	Length [mm]	weight [kg]	width [mm]	width [mm]	Front	Rear	Front	Rear
		1800	960	60	230	-	Up	-	-	-







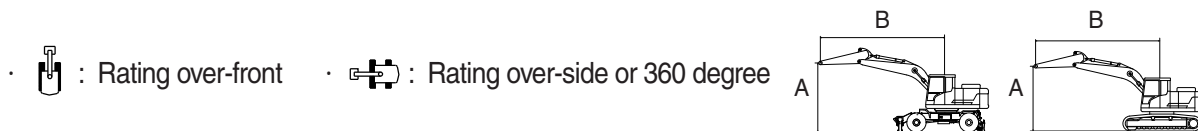

 : Rating over-front
 ·  : Rating over-side or 360 degree



Lift-point height (A)		Lift-point radius (B)						At max. reach		
		2.0 m (6.6 ft)		2.5 m (8.2 ft)		3.0 m (9.8 ft)		Capacity		Reach
										m (ft)
3.0 m (9.8 ft)	kg							*400	*400	2.20
	lb							*880	*880	(7.2)
2.5 m (8.2 ft)	kg			*370	360			320	300	2.76
	lb			*820	790			710	660	(9.1)
2.0 m (6.6 ft)	kg			380	360	280	270	270	250	3.10
	lb			840	790	620	600	600	550	(10.2)
1.5 m (4.9 ft)	kg	530	490	370	350	280	260	240	230	3.30
	lb	1170	1080	820	770	620	570	530	510	(10.8)
1.0 m (3.3 ft)	kg	500	460	360	340	270	260	230	210	3.39
	lb	1100	1010	790	750	600	570	510	460	(11.1)
0.5 m (1.6 ft)	kg	480	450	350	330	270	250	220	210	3.39
	lb	1060	990	770	730	600	550	490	460	(11.1)
Ground Line	kg	470	440	340	320	260	250	230	220	3.29
	lb	1040	970	750	710	570	550	510	490	(10.8)
-0.5 m (-1.6 ft)	kg	470	440	340	320	260	250	250	240	3.08
	lb	1040	970	750	710	570	550	550	530	(10.1)
-1.0 m (-3.3 ft)	kg	480	440	340	320			300	280	2.74
	lb	1060	970	750	710			660	620	(9.0)
-1.5 m (-4.9 ft)	kg	490	450					440	410	2.15
	lb	1080	990					970	900	(7.1)







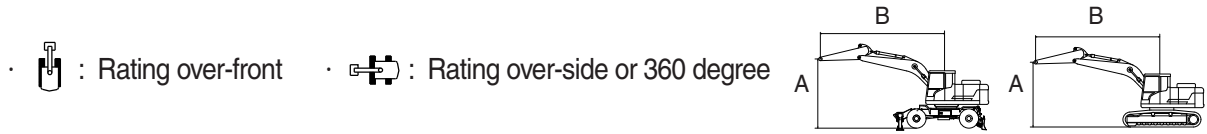

Model	Type	Boom	Arm	Counterweight	Shoe	Wheel	Dozer		Outrigger	
R18-9AK	Cab	Length [mm]	Length [mm]	weight [kg]	width [mm]	width [mm]	Front	Rear	Front	Rear
		1800	960	60	230	-	Down	-	-	-



Lift-point height (A)		Lift-point radius (B)						At max. reach		
		2.0 m (6.6 ft)		2.5 m (8.2 ft)		3.0 m (9.8 ft)		Capacity		Reach
										m (ft)
3.0 m (9.8 ft)	kg							*400	*400	2.20 (7.2)
	lb							*880	*880	
2.5 m (8.2 ft)	kg			*370	*370			*340	*340	2.76 (9.1)
	lb			*820	*820			*750	*750	
2.0 m (6.6 ft)	kg			*390	*390	*390	310	*310	300	3.10 (10.2)
	lb			*860	*860	*860	680	*680	660	
1.5 m (4.9 ft)	kg	*530	*530	*450	410	*410	310	*310	270	3.30 (10.8)
	lb	*1170	*1170	*990	900	*900	680	*680	600	
1.0 m (3.3 ft)	kg	*730	550	*530	400	*450	300	*320	250	3.39 (11.1)
	lb	*1610	1210	*1170	880	*990	660	*710	550	
0.5 m (1.6 ft)	kg	*870	530	*610	390	*480	300	*340	250	3.39 (11.1)
	lb	*1920	1170	*1340	860	*1060	660	*750	550	
Ground Line	kg	*910	520	*650	380	*500	300	*390	260	3.29 (10.8)
	lb	*2010	1150	*1430	840	*1100	660	*860	570	
-0.5 m (-1.6 ft)	kg	*880	520	*630	380	*480	290	*450	280	3.08 (10.1)
	lb	*1940	1150	*1390	840	*1060	640	*990	620	
-1.0 m (-3.3 ft)	kg	*770	520	*550	380			*460	340	2.74 (9.0)
	lb	*1700	1150	*1210	840			*1010	750	
-1.5 m (-4.9 ft)	kg	*520	*520					*440	*440	2.15 (7.1)
	lb	*1150	*1150					*970	*970	









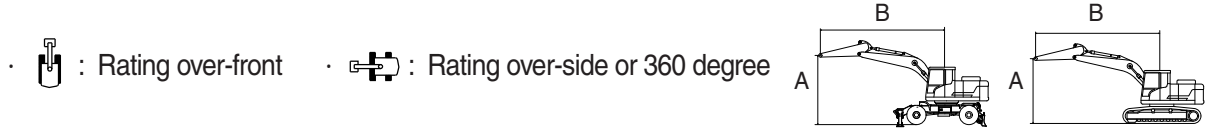

Model	Type	Boom	Arm	Counterweight	Shoe	Wheel	Dozer		Outrigger	
R18-9AK	Cab	Length [mm]	Length [mm]	weight [kg]	width [mm]	width [mm]	Front	Rear	Front	Rear
		1800	960	60	230	-	Up	-	-	-



Lift-point height (A)		Lift-point radius (B)						At max. reach		
		2.0 m (6.6 ft)		2.5 m (8.2 ft)		3.0 m (9.8 ft)		Capacity		Reach
										m (ft)
3.0 m (9.8 ft)	kg							*400	*400	2.20
	lb							*880	*880	(7.2)
2.5 m (8.2 ft)	kg			*370	*370			*340	*340	2.76
	lb			*820	*820			*750	*750	(9.1)
2.0 m (6.6 ft)	kg			*390	*390	320	300	300	280	3.10
	lb			*860	*860	710	660	660	620	(10.2)
1.5 m (4.9 ft)	kg	*530	*530	410	390	310	290	270	250	3.30
	lb	*1170	*1170	900	860	680	640	600	550	(10.8)
1.0 m (3.3 ft)	kg	560	520	400	380	310	290	260	240	3.39
	lb	1230	1150	880	840	680	640	570	530	(11.1)
0.5 m (1.6 ft)	kg	540	500	390	360	300	280	250	240	3.39
	lb	1190	1100	860	790	660	620	550	530	(11.1)
Ground Line	kg	530	490	380	360	300	280	260	250	3.29
	lb	1170	1080	840	790	660	620	570	550	(10.8)
-0.5 m (-1.6 ft)	kg	530	490	380	360	300	280	290	270	3.08
	lb	1170	1080	840	790	660	620	640	600	(10.1)
-1.0 m (-3.3 ft)	kg	540	490	390	360			340	320	2.74
	lb	1190	1080	860	790			750	710	(9.0)
-1.5 m (-4.9 ft)	kg	*520	510					*440	*440	2.15
	lb	*1150	1120					*970	*970	(7.1)









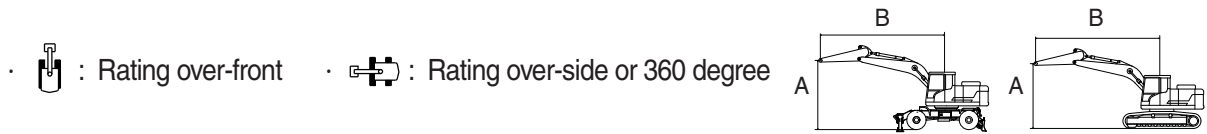

Model	Type	Boom	Arm	Counterweight	Shoe	Wheel	Dozer		Outrigger	
R18-9AK	Canopy	Length [mm]	Length [mm]	weight [kg]	width [mm]	width [mm]	Front	Rear	Front	Rear
		1800	1120	60	230	-	Down	-	-	-





Lift-point height (A)		Lift-point radius (B)								At max. reach		
		2.0 m (6.6 ft)		2.5 m (8.2 ft)		3.0 m (9.8 ft)		3.5 m (11.5 ft)		Capacity		Reach
												m (ft)
2.5 m (8.2 ft)	kg			*320	*320					*280	*280	2.96 (9.7)
	lb			*710	*710					*620	*620	
2.0 m (6.6 ft)	kg			*340	*340	*350	280			*260	240	3.27 (10.7)
	lb			*750	*750	*770	620			*570	530	
1.5 m (4.9 ft)	kg	*460	*460	*410	370	*380	280			*260	220	3.45 (11.3)
	lb	*1010	*1010	*900	820	*840	620			*570	490	
1.0 m (3.3 ft)	kg	*660	500	*500	360	*420	270	*340	210	*270	210	3.54 (11.6)
	lb	*1460	1100	*1100	790	*930	600	*750	460	*600	460	
0.5 m (1.6 ft)	kg	*830	470	*580	340	*460	260	*370	210	*280	210	3.54 (11.6)
	lb	*1830	1040	*1280	750	*1010	570	*820	460	*620	460	
Ground Line	kg	*900	460	*630	330	*490	260			*320	210	3.45 (11.3)
	lb	*1980	1010	*1390	730	*1080	570			*710	460	
-0.5 m (-1.6 ft)	kg	*890	460	*640	330	*490	260			*370	230	3.25 (10.7)
	lb	*1960	1010	*1410	730	*1080	570			*820	510	
-1.0 m (-3.3 ft)	kg	*810	460	*580	330					*430	270	2.93 (9.6)
	lb	*1790	1010	*1280	730					*950	600	
-1.5 m (-4.9 ft)	kg	*620	470							*430	360	2.42 (7.9)
	lb	*1370	1040							*950	790	

Model	Type	Boom	Arm	Counterweight	Shoe	Wheel	Dozer		Outrigger	
R18-9AK	Canopy	Length [mm]	Length [mm]	weight [kg]	width [mm]	width [mm]	Front	Rear	Front	Rear
		1800	1120	60	230	-	Up	-	-	-









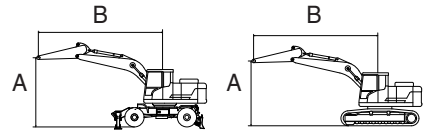



Lift-point height (A)		Lift-point radius (B)								At max. reach		
		2.0 m (6.6 ft)		2.5 m (8.2 ft)		3.0 m (9.8 ft)		3.5 m (11.5 ft)		Capacity		Reach
												m (ft)
2.5 m (8.2 ft)	kg			*320	*320					*280	270	2.96
	lb			*710	*710					*620	600	(9.7)
2.0 m (6.6 ft)	kg			*340	*340	280	270			240	230	3.27
	lb			*750	*750	620	600			530	510	(10.7)
1.5 m (4.9 ft)	kg	*460	*460	370	350	280	260			220	210	3.45
	lb	*1010	*1010	820	770	620	570			490	460	(11.3)
1.0 m (3.3 ft)	kg	500	470	360	340	270	260	210	200	210	200	3.54
	lb	1100	1040	790	750	600	570	460	440	460	440	(11.6)
0.5 m (1.6 ft)	kg	480	440	350	320	270	250	210	200	210	200	3.54
	lb	1060	970	770	710	600	550	460	440	460	440	(11.6)
Ground Line	kg	470	430	340	320	260	240			210	200	3.45
	lb	1040	950	750	710	570	530			460	440	(11.3)
-0.5 m (-1.6 ft)	kg	460	430	330	310	260	240			230	220	3.25
	lb	1010	950	730	680	570	530			510	490	(10.7)
-1.0 m (-3.3 ft)	kg	470	430	340	310					270	250	2.93
	lb	1040	950	750	680					600	550	(9.6)
-1.5 m (-4.9 ft)	kg	480	440							360	340	2.42
	lb	1060	970							790	750	(7.9)

Model	Type	Boom	Arm	Counterweight	Shoe	Wheel	Dozer		Outrigger	
R18-9AK	Cab	Length [mm]	Length [mm]	weight [kg]	width [mm]	width [mm]	Front	Rear	Front	Rear
		1800	1120	60	230	-	Down	-	-	-









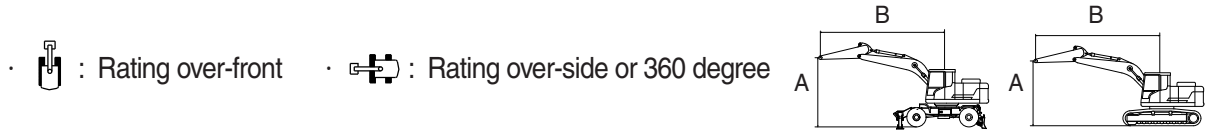

 : Rating over-front
  : Rating over-side or 360 degree



Lift-point height (A)		Lift-point radius (B)								At max. reach		
		2.0 m (6.6 ft)		2.5 m (8.2 ft)		3.0 m (9.8 ft)		3.5 m (11.5 ft)		Capacity		Reach
												m (ft)
2.5 m (8.2 ft)	kg			*320	*320					*280	*280	2.96
	lb			*710	*710					*620	*620	(9.7)
2.0 m (6.6 ft)	kg			*340	*340	*350	310			*260	*260	3.27
	lb			*750	*750	*770	680			*570	*570	(10.7)
1.5 m (4.9 ft)	kg	*460	*460	*410	*410	*380	310			*260	250	3.45
	lb	*1010	*1010	*900	*900	*840	680			*570	550	(11.3)
1.0 m (3.3 ft)	kg	*660	550	*500	400	*420	300	*340	240	*270	240	3.54
	lb	*1460	1210	*1100	880	*930	660	*750	530	*600	530	(11.6)
0.5 m (1.6 ft)	kg	*830	530	*580	380	*460	300	*370	240	*280	230	3.54
	lb	*1830	1170	*1280	840	*1010	660	*820	530	*620	510	(11.6)
Ground Line	kg	*900	520	*630	380	*490	290			*320	240	3.45
	lb	*1980	1150	*1390	840	*1080	640			*710	530	(11.3)
-0.5 m (-1.6 ft)	kg	*890	510	*640	370	*490	290			*370	260	3.25
	lb	*1960	1120	*1410	820	*1080	640			*820	570	(10.7)
-1.0 m (-3.3 ft)	kg	*810	520	*580	370					*430	300	2.93
	lb	*1790	1150	*1280	820					*950	660	(9.6)
-1.5 m (-4.9 ft)	kg	*620	530							*430	400	2.42
	lb	*1370	1170							*950	880	(7.9)

Model	Type	Boom	Arm	Counterweight	Shoe	Wheel	Dozer		Outrigger	
R18-9AK	Cab	Length [mm]	Length [mm]	weight [kg]	width [mm]	width [mm]	Front	Rear	Front	Rear
		1800	1120	60	230	-	Up	-	-	-



Lift-point height (A)		Lift-point radius (B)								At max. reach		
		2.0 m (6.6 ft)		2.5 m (8.2 ft)		3.0 m (9.8 ft)		3.5 m (11.5 ft)		Capacity		Reach
												m (ft)
2.5 m (8.2 ft)	kg			*320	*320					*280	*280	2.96
	lb			*710	*710					*620	*620	(9.7)
2.0 m (6.6 ft)	kg			*340	*340	320	300			*260	260	3.27
	lb			*750	*750	710	660			*570	570	(10.7)
1.5 m (4.9 ft)	kg	*460	*460	*410	390	310	290			250	230	3.45
	lb	*1010	*1010	*900	860	680	640			550	510	(11.3)
1.0 m (3.3 ft)	kg	560	520	400	370	310	290	240	230	240	220	3.54
	lb	1230	1150	880	820	680	640	530	510	530	490	(11.6)
0.5 m (1.6 ft)	kg	540	500	390	360	300	280	240	220	240	220	3.54
	lb	1190	1100	860	790	660	620	530	490	530	490	(11.6)
Ground Line	kg	530	480	380	350	290	280			240	230	3.45
	lb	1170	1060	840	770	640	620			530	510	(11.3)
-0.5 m (-1.6 ft)	kg	520	480	380	350	290	270			260	250	3.25
	lb	1150	1060	840	770	640	600			570	550	(10.7)
-1.0 m (-3.3 ft)	kg	530	480	380	350					300	280	2.93
	lb	1170	1060	840	770					660	620	(9.6)
-1.5 m (-4.9 ft)	kg	540	490							410	380	2.42
	lb	1190	1080							900	840	(7.9)

6. BUCKET SELECTION GUIDE

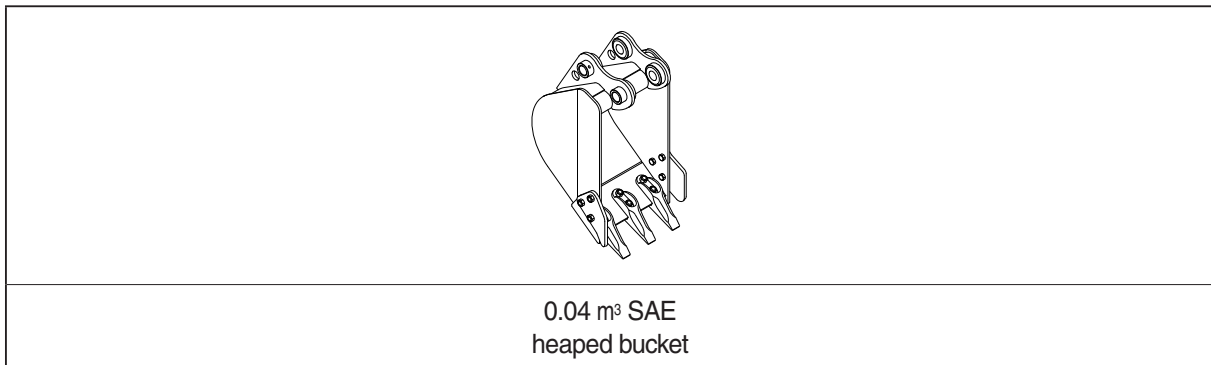

Capacity		Width		Weight	Recommendation
SAE heaped	CECE heaped	Without side cutter	With side cutter		1.8 m (5' 11") boom
					0.96 m (3' 2") arm
0.04m ³ (0.05 yd ³)	0.03 m ³ (0.04 yd ³)	390 mm (15.4")	440 mm (17.3")	43 kg (95 lb)	Applicable for materials with density of 1600 kg/m ³ (2700 lb /yd ³) or less

7. UNDERCARRIAGE

(1) TRACKS

X-leg type center frame is integrally welded with reinforced box-section track frames. The design includes dry tracks, lubricated rollers, idlers, sprockets, hydraulic track adjusters with shock absorbing springs and assembled track-type tractor shoes with triple grousers.

(2) TYPES OF SHOES

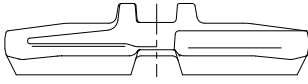
Model	Shapes		Rubber track
			
R18-9AK	Shoe width	mm (in)	230 (9")
	Operating weight (canopy / cabin)	kg (lb)	1855 (4089) / 1995 (4398)
	Ground pressure	kgf/cm ² (psi)	0.3 (4.24) / 0.32 (4.56)
	Overall width	mm (ft-in)	1250 (4' 1")

(3) NUMBER OF ROLLERS AND SHOES ON EACH SIDE

Item	Quantity
Track rollers	3 EA

8. SPECIFICATIONS FOR MAJOR COMPONENTS

1) ENGINE

Item	Specification
Model	KUBOTA D902
Type	4-cycle vertical overhead valve, diesel fuel
Cooling method	Water cooling
Number of cylinders and arrangement	3 cylinders, in-line
Firing order	1-2-3
Combustion chamber type	Spherical type
Cylinder bore × stroke	72.0 × 73.6 mm (2.83" × 2.90")
Piston displacement	898 cc (54.80 cu in)
Compression ratio	24 : 1
Rated gross horse power (SAE J1995)	16.2 Hp at 2400 rpm (12.1 kW at 2400 rpm)
Maximum torque at 1800 rpm	5.57 kgf · m (40.3 lbf · ft)
Engine oil quantity	3.7 l (1.0 U.S. gal)
Dry weight	75 kg (165 lb)
High idling speed	2720 ± 50 rpm
Low idling speed	1500 ± 50 rpm
Rated fuel consumption	186 g/HP · hr at 2400 rpm (250 g/kW · hr at 2400 rpm)
Starting motor	12V-1.2 kW
Alternator	12V-40 A
Battery	1 × 12 V × 80 Ah

2) MAIN PUMP

Item	Specification
Type	Variable displacement tandem axis piston pumps
Capacity	2 × 7.5 cc/rev
Rated oil flow	2 × 18 l /min (4.8 U.S. gpm / 4.0 U.K. gpm)
Rated speed	2400 rpm

3) GEAR PUMP

Item	Specification
Type	Fixed displacement gear pump single stage
Capacity	4.5/2.7 cc/rev
Rated oil flow	10.8/6.5 l /min (2.9/1.7 U.S. gpm / 2.4/1.4 U.K. gpm)

4) MAIN CONTROL VALVE

Item	Specification
Type	Sectional, 9 spools (12 blocks)
Operating method	Hydraulic pilot system
Main relief valve pressure (P1,P2 / P3)	210 kgf/cm ² (2990 psi) / 200 kgf/cm ² (2840 psi)
Overload relief valve pressure	230 kgf/cm ² (3270 psi)

5) SWING MOTOR

Item	Specification
Type	Fixed displacement axial piston motor
Capacity	18.1 cc/rev
Relief pressure	165 kgf/cm ² (2350 psi)
Reduction gear type	1 - stage planetary

6) TRAVEL MOTOR

Item	Specification
Type	Variable displacement axial piston motor
Relief pressure	210 kgf/cm ² (2990 psi)
Reduction gear type	2-stage planetary

7) CYLINDER

Item		Specification
Boom cylinder	Bore dia × Rod dia × Stroke	ø 60 × ø 40 × 465 mm
	Cushion	Extend only
Arm cylinder	Bore dia × Rod dia × Stroke	ø 60 × ø 40 × 400 mm
	Cushion	Extend and retract
Bucket cylinder	Bore dia × Rod dia × Stroke	ø 55 × ø 35 × 345 mm
	Cushion	-
Boom swing cylinder	Bore dia × Rod dia × Stroke	ø 55 × ø 30 × 355 mm
	Cushion	-
Dozer cylinder	Bore dia × Rod dia × Stroke	ø 65 × ø 30 × 93 mm
	Cushion	-

※ Discoloration of cylinder rod can occur when the friction reduction additive of lubrication oil spreads on the rod surface.

※ Discoloration does not cause any harmful effect on the cylinder performance.

8) BUCKET

Item	Capacity		Tooth quantity	Width	
	SAE heaped	CECE heaped		Without side cutter	With side cutter
Standard	0.04 m ³ (0.05 yd ³)	0.03 m ³ (0.04 yd ³)	3	390 mm (15.4")	440 mm (17.3")

9. RECOMMENDED OILS

HYUNDAI genuine lubricating oils have been developed to offer the best performance and service life for your equipment. These oils have been tested according to the specifications of HYUNDAI and, therefore, will meet the highest safety and quality requirements.

We recommend that you use only HYUNDAI genuine lubricating oils and grease officially approved by HYUNDAI.

Service point	Kind of fluid	Capacity ℓ (U.S. gal)	Ambient temperature °C (°F)							
			-50 (-58)	-30 (-22)	-20 (-4)	-10 (14)	0 (32)	10 (50)	20 (68)	30 (86)
Engine oil pan	Engine oil	3.7 (1.0)	★SAE 5W-40				SAE 30			
			SAE 10W				SAE 10W-30			
			SAE 15W-40							
Final drive	Gear oil	0.33 × 2 (0.09 × 2)	★SAE 75W-90				SAE 85W-140			
Hydraulic tank	Hydraulic oil	Tank; 20 (5.3)	★ISO VG 15				ISO VG 46, HBHO VG 46★ ³			
							ISO VG 68			
		System; 30 (7.9)								
Fuel tank	Diesel fuel★ ¹	21 (5.5)	★ASTM D975 NO.1				ASTM D975 NO.2			
Fitting (grease nipple)	Grease	As required	★NLGI NO.1				NLGI NO.2			
Radiator (reservoir tank)	Mixture of antifreeze and soft water★ ²	4 (1.1)	Ethylene glycol base permanent type (50 : 50)							
			★Ethylene glycol base permanent type (60 : 40)							

SAE : Society of Automotive Engineers

API : American Petroleum Institute

ISO : International Organization for Standardization

NLGI : National Lubricating Grease Institute

ASTM : American Society of Testing and Material

★ : Cold region (Russia, CIS, Mongolia)

★¹ : Ultra low sulfur diesel

- sulfur content ≤ 15 ppm

★² : Soft water

City water or distilled water

★³ : Hyundai Bio Hydraulic Oil

※ Using any lubricating oils other than HYUNDAI genuine products may lead to a deterioration of performance and cause damage to major components.

※ Do not mix HYUNDAI genuine oil with any other lubricating oil as it may result in damage to the systems of major components.

※ Do not use any engine oil other than that specified above, as it may clog the diesel particulate filter(DPF).

※ For HYUNDAI genuine lubricating oils and grease for use in regions with extremely low temperatures, please contact HYUNDAI dealers.