

SECTION 5 MECHATRONICS SYSTEM

Group 1 Outline.....	5-1
Group 2 Mode Selection System	5-3
Group 3 Automatic Deceleration System	5-6
Group 4 Power Boost System	5-7
Group 5 Travel Speed Control System	5-8
Group 6 Automatic Warming Up System	5-9
Group 7 Engine Overheat Prevention System	5-10
Group 8 Variable Power Control System	5-11
Group 9 Attachment Flow Control System	5-12
Group 10 Anti-Restart System	5-13
Group 11 Self-Diagnostic System	5-14
Group 12 Engine Control System	5-20
Group 13 EPPR Valve	5-21
Group 14 Monitoring System	5-26
Group 15 Fuel Warmer System	5-49

SECTION 5 MECHATRONICS SYSTEM

GROUP 1 OUTLINE

The ADVANCED CAPO (Computer Aided Power Optimization) system controls engine and pump mutual power at an optimum and less fuel consuming state for the selected work by mode selection, auto-deceleration, power boost function, etc. It monitors machine conditions, for instance, engine speed, coolant temperature, hydraulic oil temperature, and hydraulic oil pressure, etc. It consists of a MCU, a cluster, an ECM, EPPR valves, and other components. The MCU and the cluster protect themselves from over-current and high voltage input, and diagnose malfunctions caused by short or open circuit in electric system, and display error codes on the cluster.

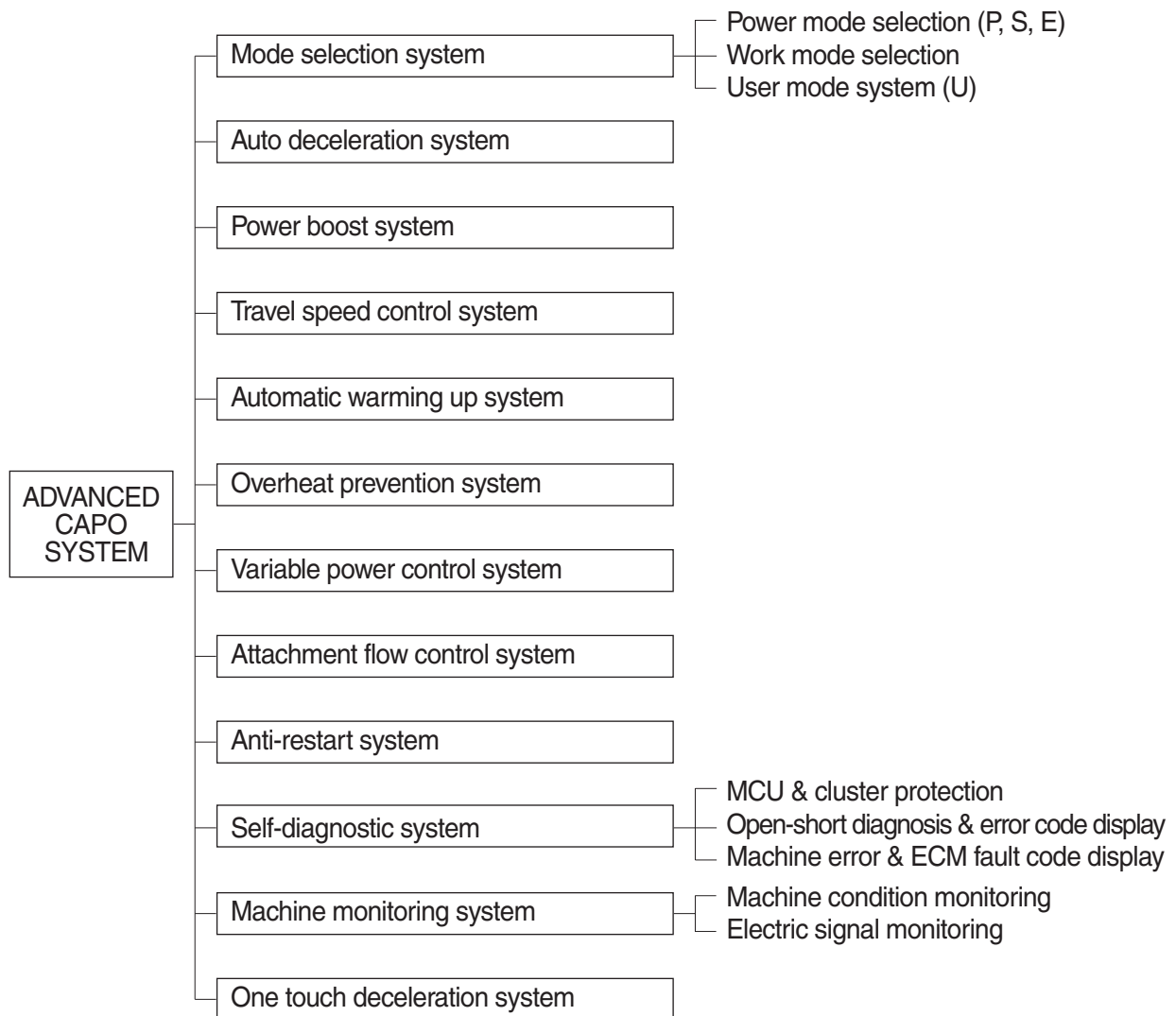

SYSTEM DIAGRAM

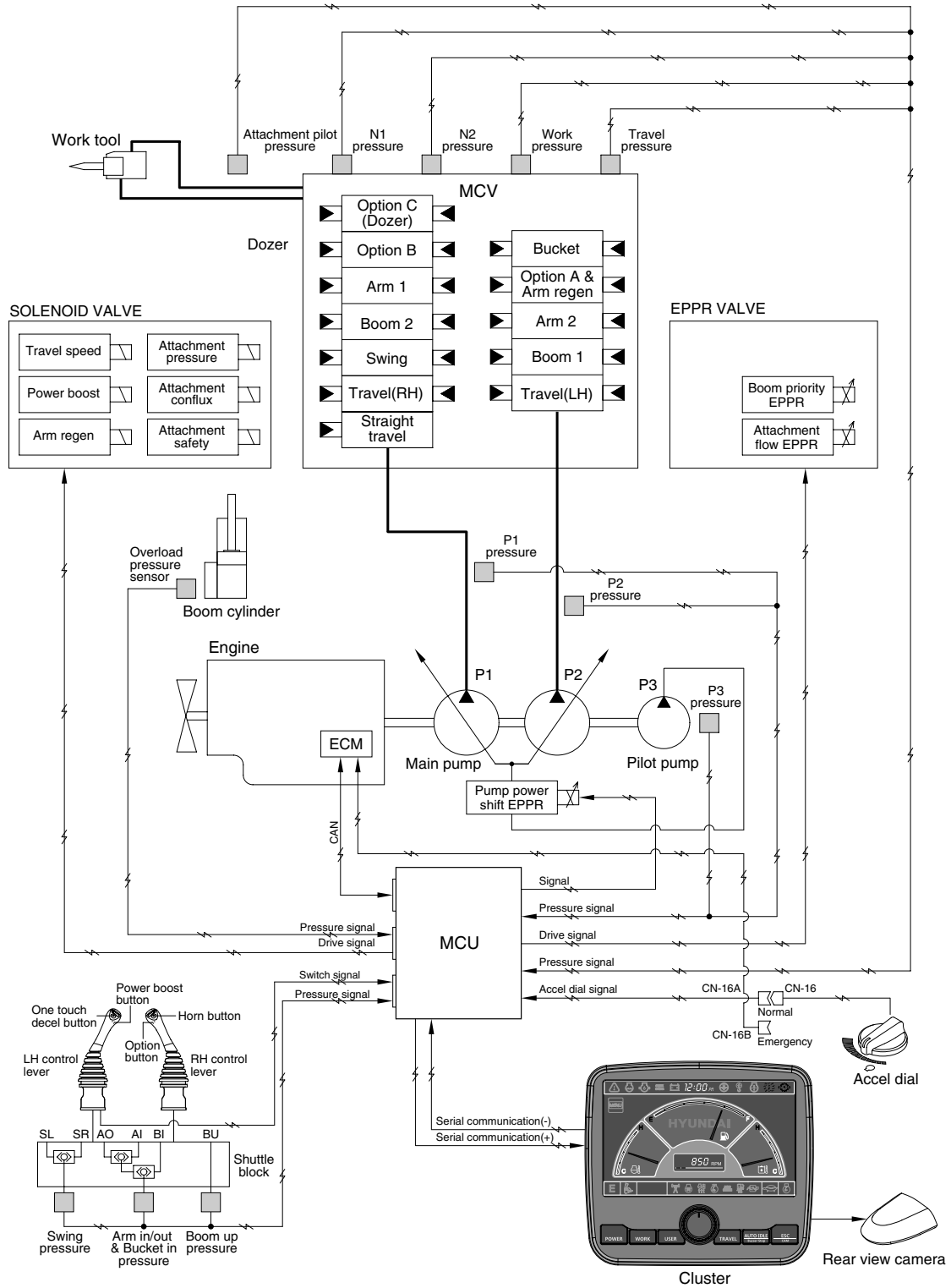

14095MS01

GROUP 2 MODE SELECTION SYSTEM

1. POWER MODE SELECTION SYSTEM

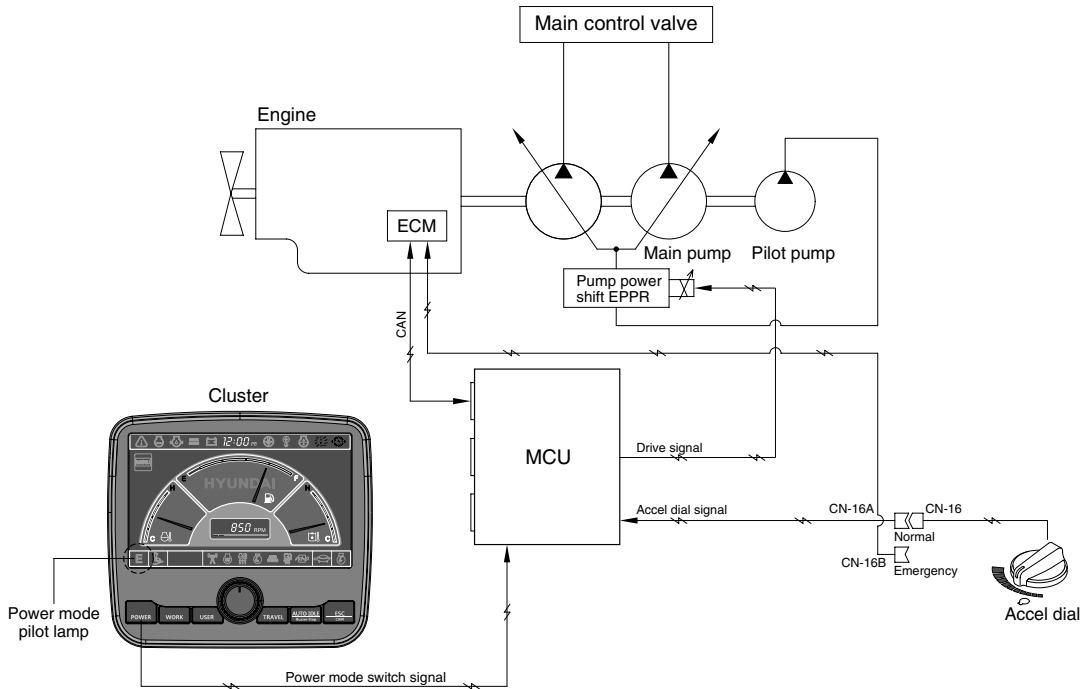

21095MS02

Mode selection system (micro computer based electro-hydraulic pump and engine mutual control system) optimizes the engine and pump performance.

The combination of 3 power modes (P, S, E) and accel dial position (10 set) makes it possible to use the engine and pump power more effectively corresponding to the work conditions from a heavy and great power requesting work to a light and precise work.

Power mode	Application	Engine rpm				Power shift by EPPR valve			
		Standard		Option		Standard		Option	
		Unload	Load	Unload	Load	Current (mA)	Pressure (kgf/cm ²)	Current (mA)	Pressure (kgf/cm ²)
P	Heavy duty power	2100±50	2000±50	2100±50	2000±50	230±30	4	160±30	0
S	Standard power	1900±50	1800±50	1900±50	1800±50	330±30	10±3	330±30	10±3
E	Economy operation	1750±50	1800±50	1750±50	1800±50	400±30	15±3	400±30	15±3
AUTO DECEL	Engine deceleration	1000±100	-	1000±100	-	700±30	38±3	700±30	38±3
One touch decel	Engine quick deceleration	950±100	-	950±100	-	700±30	38±3	700±30	38±3
KEY START	Key switch start position	950±100	-	950±100	-	700±30	38±3	700±30	38±3

※ Power shift (Standard/Option) can be changed by "Service menu" in "Management" on the cluster.

2. WORK MODE SELECTION SYSTEM

Work mode consists of the general operation (bucket) and the optional attachment (breaker, crusher).

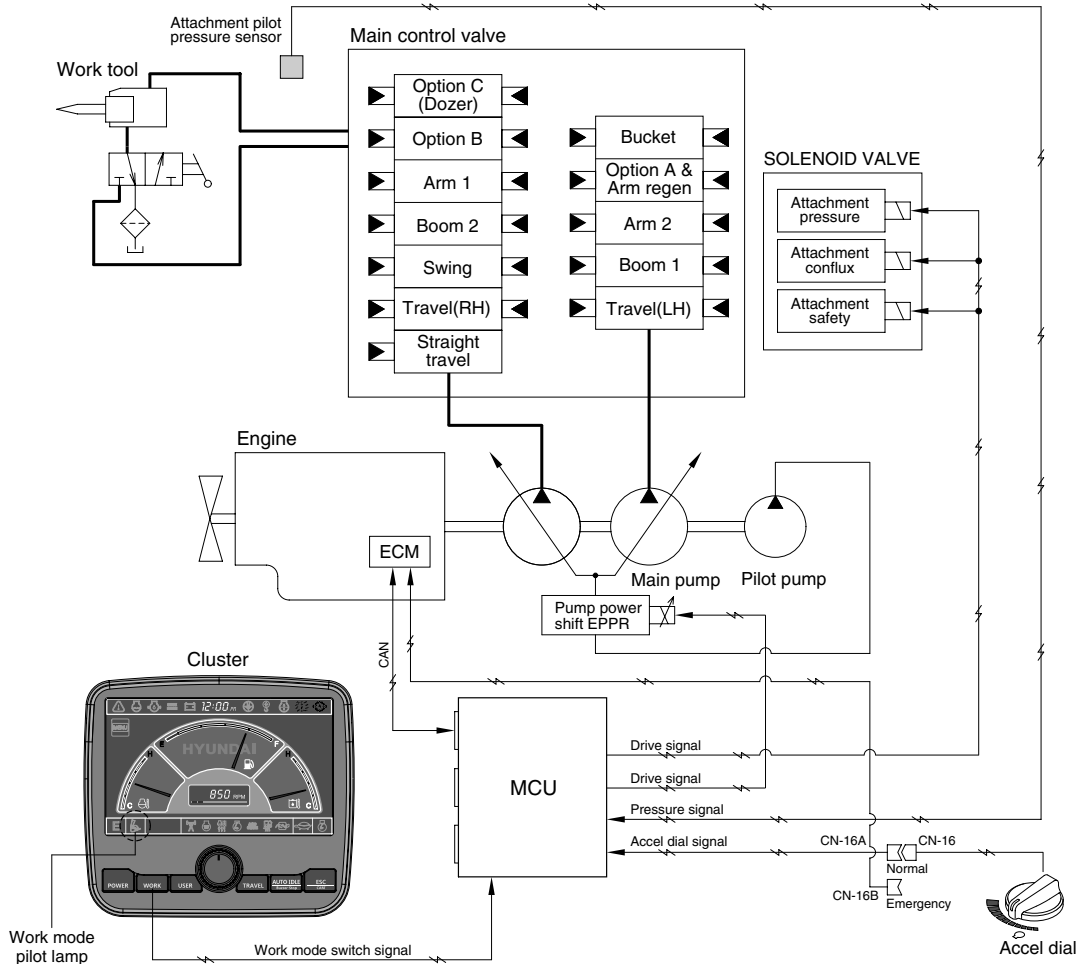

14095MS03

1) GENERAL WORK MODE (bucket)

This mode is used to general digging work.

2) ATT WORK MODE (breaker, crusher)

It controls the pump flow and system pressure according to the operation of breaker or crusher.

Description	General mode	Work tool	
	Bucket	Breaker	Crusher
Attachment safety solenoid	OFF	ON	ON
Attachment pressure solenoid	OFF	OFF	ON
Attachment conflux solenoid	OFF	OFF	ON/OFF
Attachment flow EPPR current	100 mA	100~700 mA	100~700 mA

3. USER MODE SELECTION SYSTEM

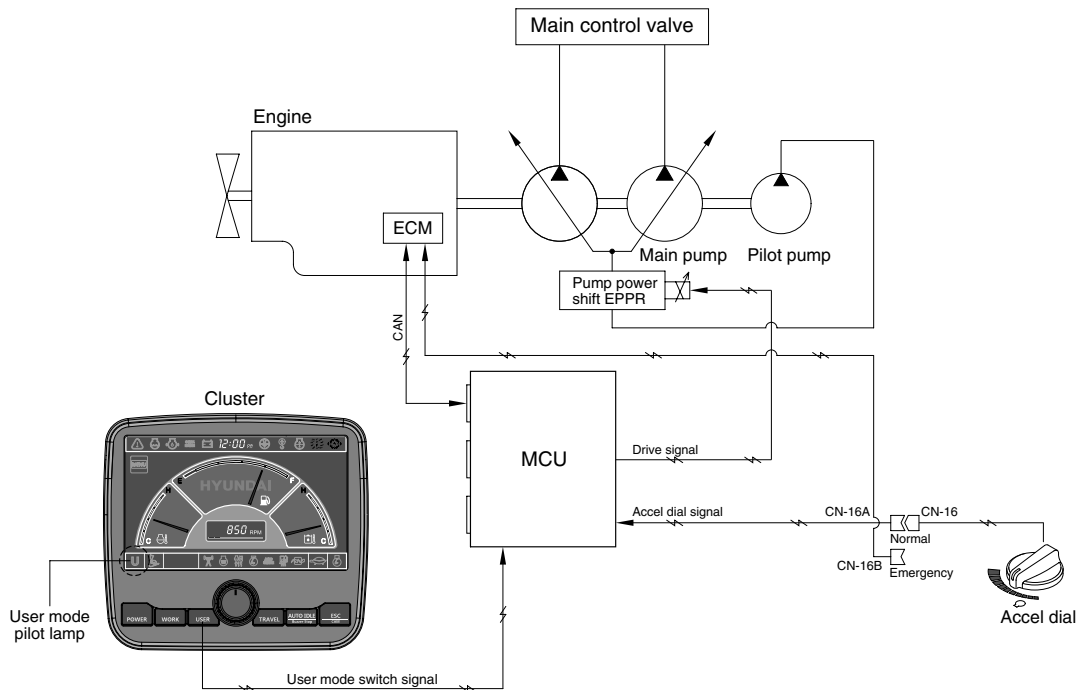

21095MS03A

1) High idle rpm, auto idle rpm and EPPR pressure can be adjusted and memorized in the U-mode.

2) LCD segment vs parameter setting

Step ()	Engine speed (rpm)	Idle speed (rpm)	Power shift (bar)
1	1650	800	0
2	1700	850	3
3	1750	900	6
4	1800	950 (low idle)	9
5	1850	1000 (decel rpm)	12
6	1900	1050	16
7	1950	1100	20
8	2000	1150	26
9	2050	1200	32
10	2100	1250	38

GROUP 3 AUTOMATIC DECELERATION SYSTEM

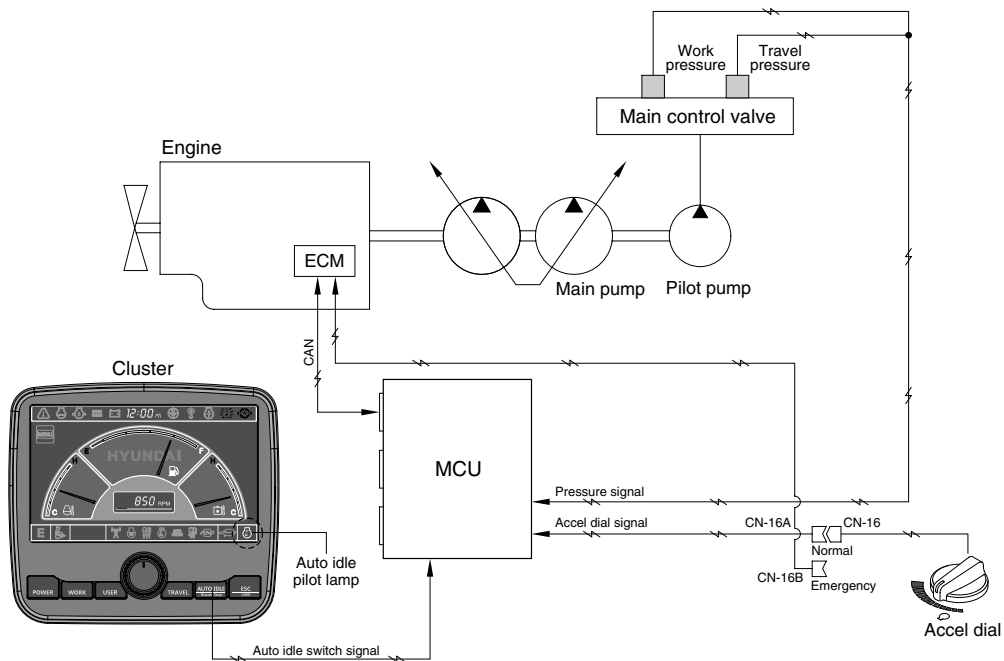

21095MS04

1. WHEN AUTO IDLE PILOT LAMP ON

When all of the work equipment control levers including swing and travel levers are at neutral for 4 seconds, MCU sends throttle command to ECM to reduce the engine speed to 1000 rpm. If the control levers are at neutral for 1 minute, MCU reduces the engine speed to 950 rpm. As the result of reducing the engine speed, fuel consumption and noise are effectively cut down during non-operation of the control levers.

When the Auto idle pilot lamp is turned off by pressing the switch or any control lever is operated, the reduced engine speed rises up to the speed before deceleration in a second.

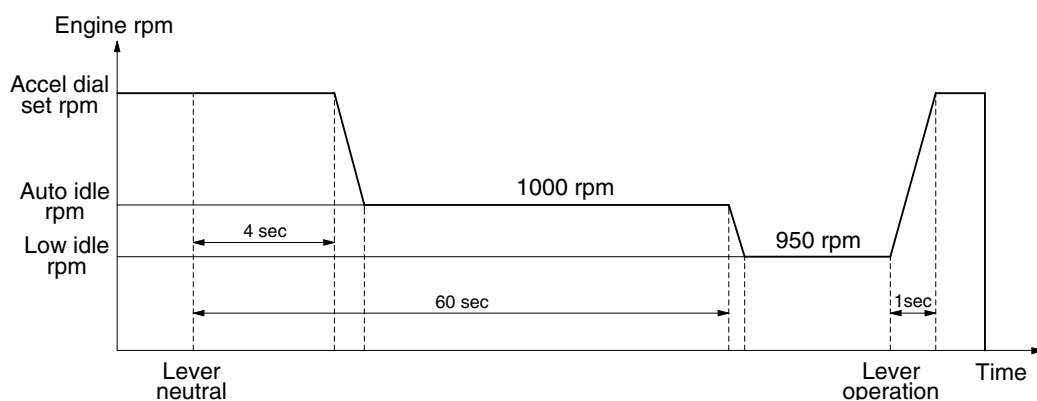

16095MS05

2. WHEN AUTO IDLE PILOT LAMP OFF

The engine speed can be set as desired using the accel dial switch, and even if the control levers are neutral, the engine speed is not reduced.

※ Auto idle function can be activated when accel dial position is over 4.

GROUP 4 POWER BOOST SYSTEM

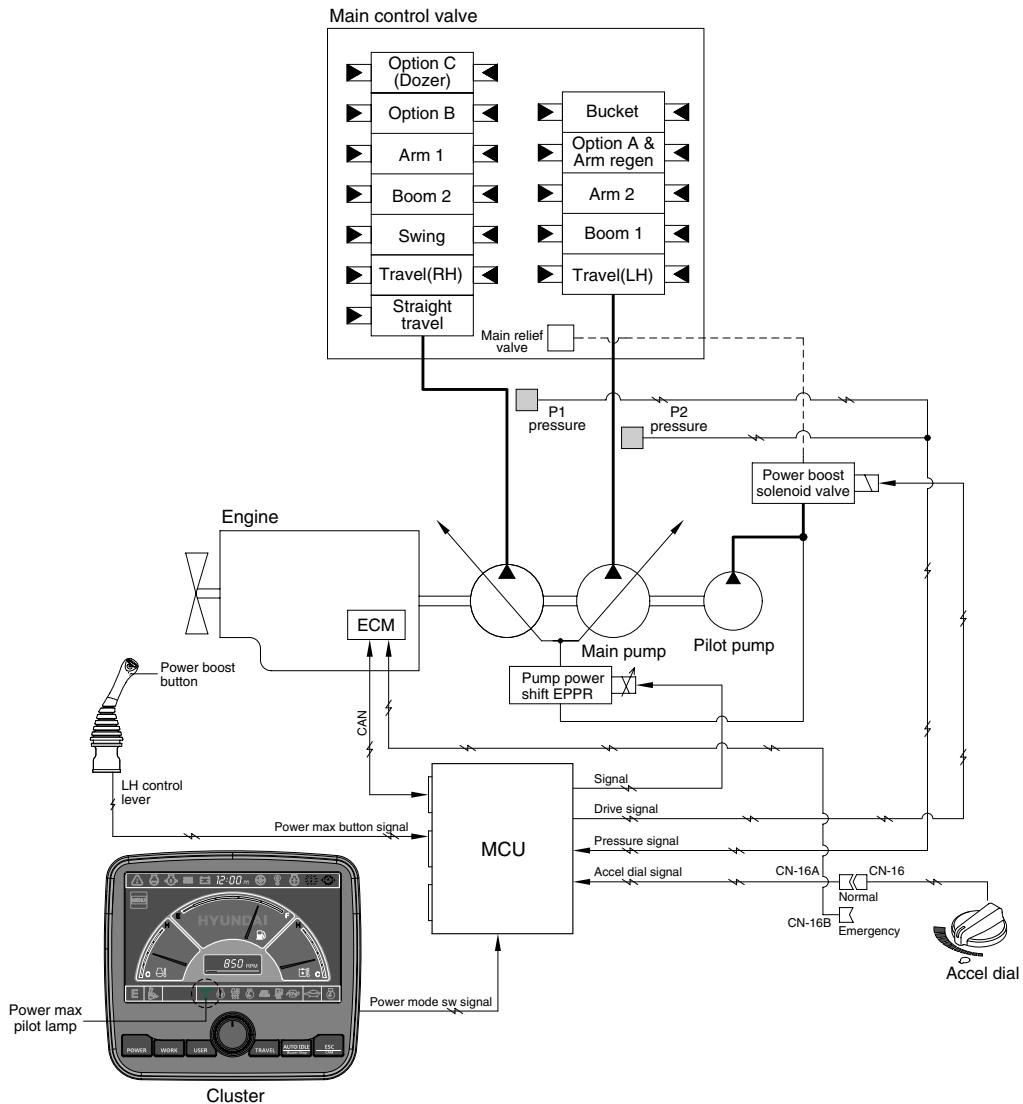

14095MS06

- When the power boost switch on the left control lever knob is pushed ON, the power mode is set P mode and maximum digging power is increased by 10 %.
- When the power boost function is activated, the power boost solenoid valve pilot pressure raises the set pressure of the main relief valve to increase the digging power.

Description	Condition	Function
Activated	Power boost switch : ON Accel dial : over 8	- Power mode : P - Accel dial power : 9 - Power boost solenoid : ON - Power boost pilot lmap : ON - Operating time : max 8 seconds
Canceled	Power boost switch : OFF	- Pre-set power mode - Power boost solenoid : OFF - Power boost pilot lamp : OFF

※ When the auto power boost is set to Enable and power mode is set to P mode on the cluster, the digging power is automatically increased as working conditions by the MCU. It is operated max 8 seconds.

GROUP 5 TRAVEL SPEED CONTROL SYSTEM

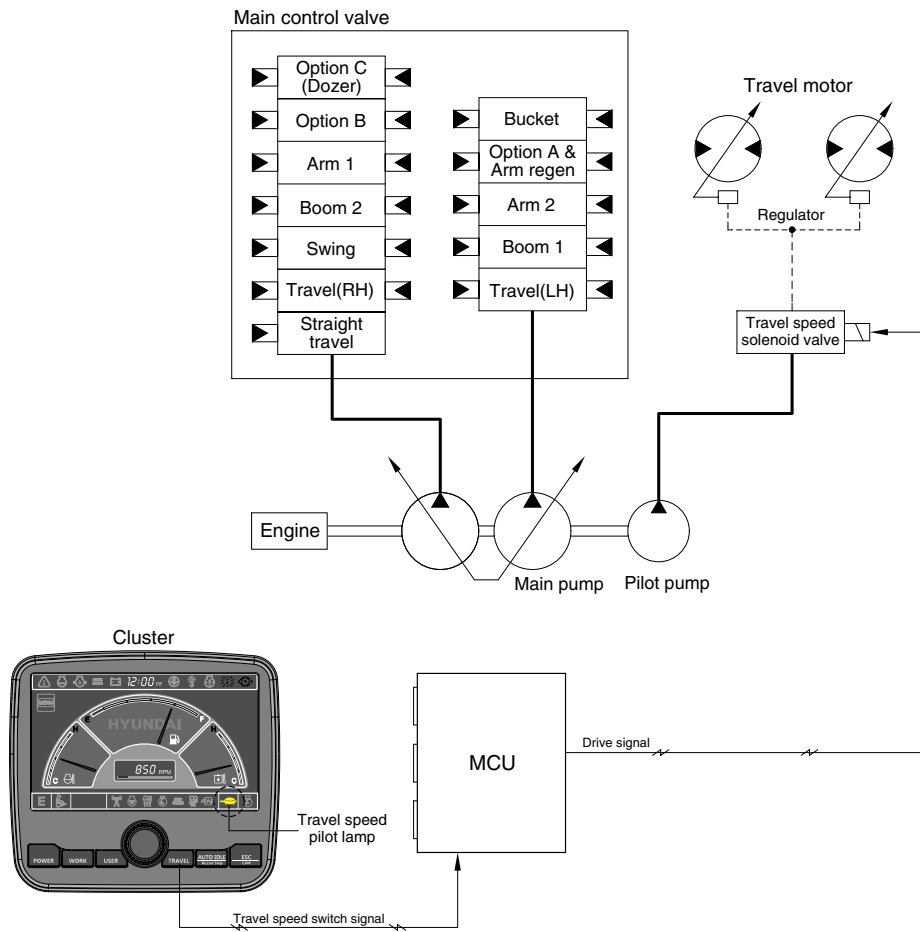

14095MS07

Travel speed can be switched manually by pressing the travel speed switch on the cluster.

Speed	Travel speed solenoid valve	Lamp on cluster	Operation
Low	OFF	Turtle	Low speed, high driving torque in the travel motor
High	ON	Rabbit	High speed, low driving torque in the travel motor

※ Default : Turtle (Low)

GROUP 6 AUTOMATIC WARMING UP SYSTEM

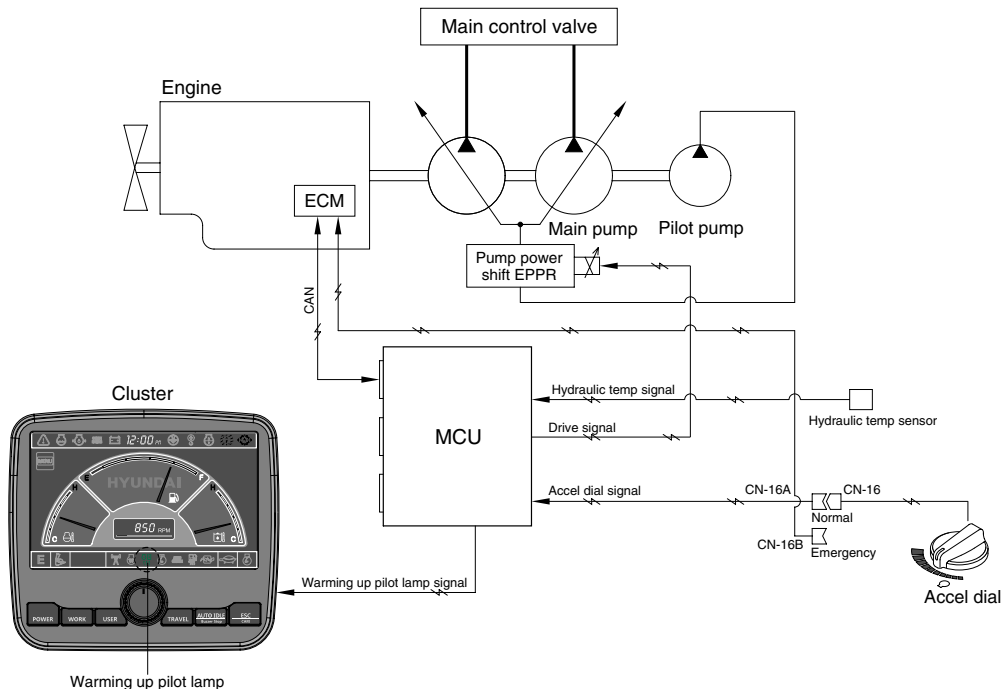

21095MS08

1. The MCU receives the engine coolant temperature from the ECM, and if the coolant temperature is below 30°C, it increases the engine speed from key start rpm to 1200rpm. At this time the mode does not change. If the coolant temperature sensor has fault, the hydraulic oil temperature signal is substituted.
2. In case of the coolant temperature increases up to 30°C, the engine speed is decreased to key start speed. And if an operator changes power mode set during the warming up function, the MCU cancels the automatic warming up function.

3. LOGIC TABLE

Description	Condition	Function
Actuated	- Coolant temperature : below 30°C (after engine run)	- Power mode : Default (E mode) - Warming up time : 10 minutes (max) - Warming up pilot lamp : ON
Canceled	- Coolant temperature : Above 30°C - Warming up time : Above 10 minutes - Changed power mode set by operator - RCV lever or pedal operating - Auto idle cancel ※ If any of the above conditions is applicable, the automatic warming up function is canceled	- Power mode : set mode - Warming up pilot lamp : OFF

GROUP 7 ENGINE OVERHEAT PREVENTION SYSTEM

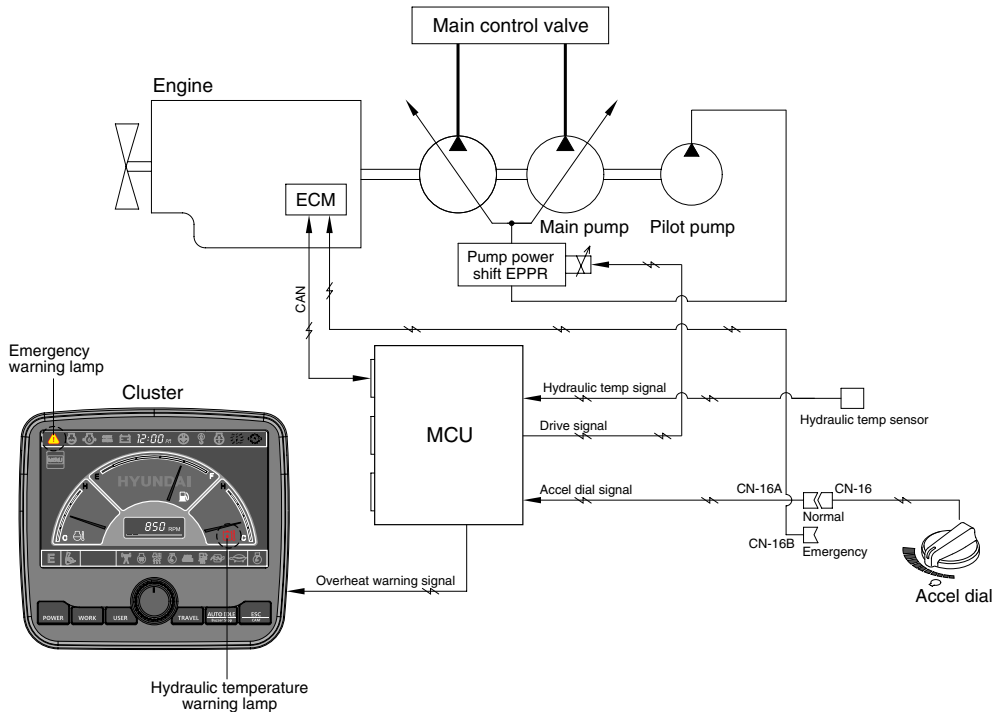

21095MS09

1. If the engine coolant temperature or the hydraulic oil temperature is overheated over 100°C, the warning lamp is ON and the pump input torque or the engine speed is reduced as below logic table.

2. LOGIC TABLE

Description		Condition	Function
First step warning	Activated	- Coolant temperature : Above 103°C - Hydraulic oil temperature : Above 100°C	- Warning lamp : ON , buzzer : OFF - Pump input torque is reduced.
	Canceled	- Coolant temperature : Less than 100°C - Hydraulic oil temperature : Less than 95°C	- Warning lamp & buzzer : ON - Pump input torque is reduced.
Second step warning	Activated	- Coolant or hydraulic oil temperature : Above 105°C	- Emergency warning lamp pops up on the center of LCD and the buzzer sounds. - Engine speed is reduced after 10 seconds.
	Canceled	- Coolant temperature : Less than 103°C - Hydraulic oil temperature : Less than 100°C	- Return to pre-set the engine speed. - Hold pump absorption torque on the first step warning.

GROUP 8 VARIABLE POWER CONTROL SYSTEM

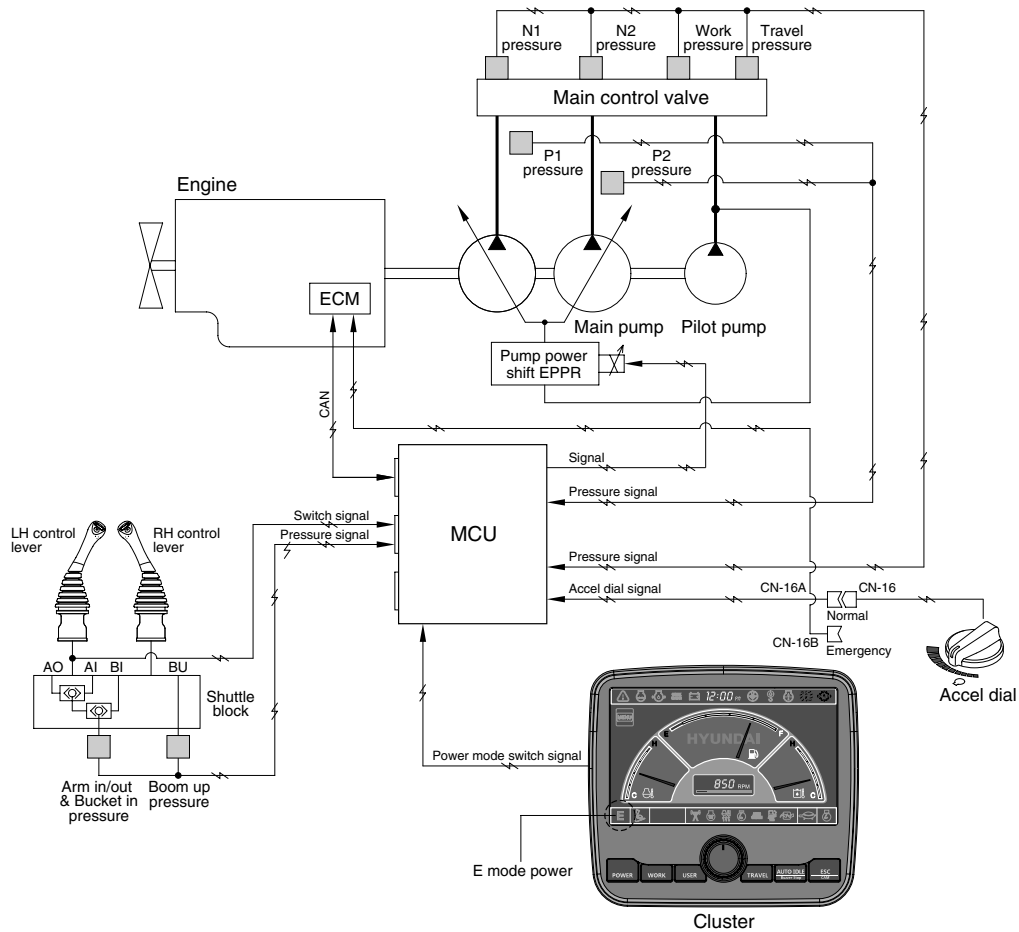

21095MS10

- The variable power control system controls the engine and pump mutual power according to RCV lever stroke and pump load. It makes fuel saving and smooth control at precise work.

Description	Working condition
Power mode	E
Work mode	General (bucket)
Pressure sensor	Normal

※ The variable power control function can be activated when the power mode is set to E mode.

GROUP 9 ATTACHMENT FLOW CONTROL SYSTEM

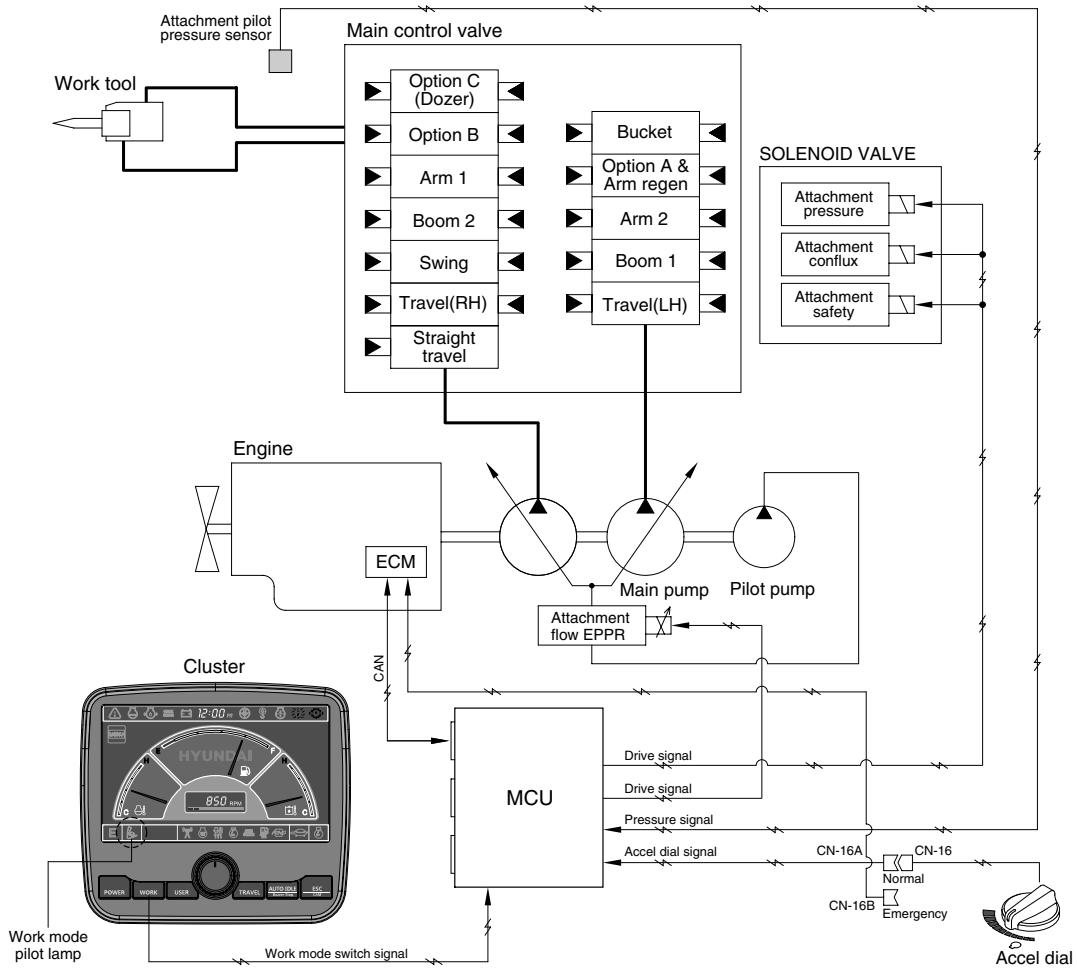

14095MS11

- The system is used to control the pump delivery flow according to set of the work tool on the cluster by the attachment flow EPPR valve.

Description	Work tool	
	Breaker	Crusher
Flow level	Max 7 step, reduced 10 lpm each step	Max 4 step, reduced 20 lpm each step
Attach safety solenoid	ON	ON
Attach pressure solenoid	OFF	ON
Attach conflux solenoid	OFF	ON/OFF

※ Refer to the page 5-38 for the attachment kinds and max flow.

GROUP 10 ANTI-RESTART SYSTEM

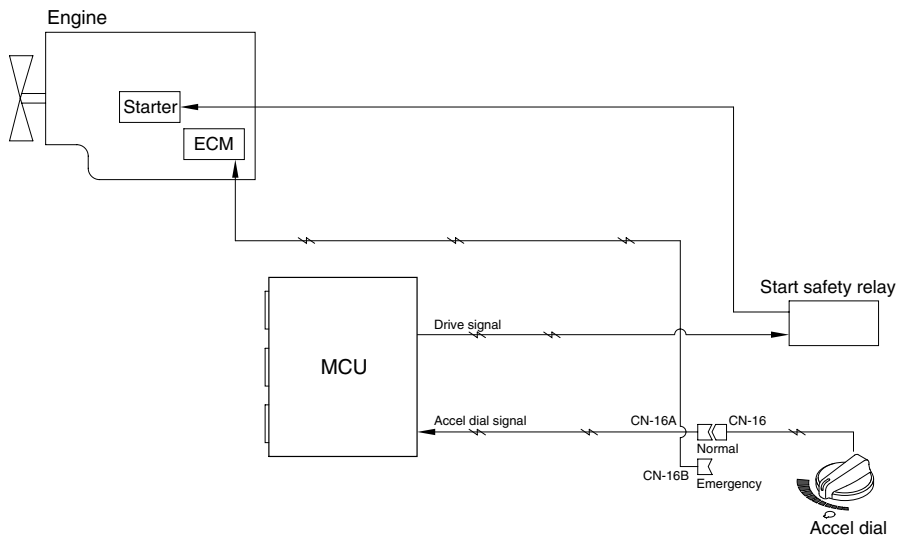

21095MS12

1. ANTI-RESTART FUNCTION

After a few seconds from the engine starts to run, MCU turns off the start safety relay to protect the starter from inadvertent restarting.

2. When a replacement or taking-off of the MCU is needed, connect CN-16 and CN-16B to ensure the engine start without the MCU.

GROUP 11 SELF-DIAGNOSTIC SYSTEM

1. OUTLINE

When any abnormality occurs in the NEW CAPO system caused by electric parts malfunction and by open or short circuit, the MCU diagnoses the problem and sends the error codes to the cluster and also stores them in the memory.

2. MONITORING

1) Active fault

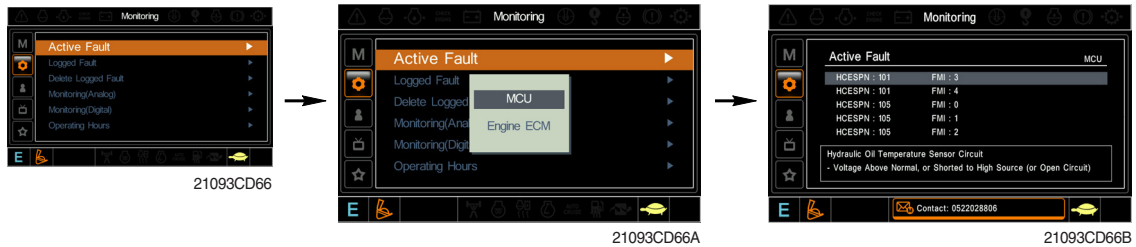

- The active faults of the MCU or engine ECM can be checked by this menu.

2) Logged fault

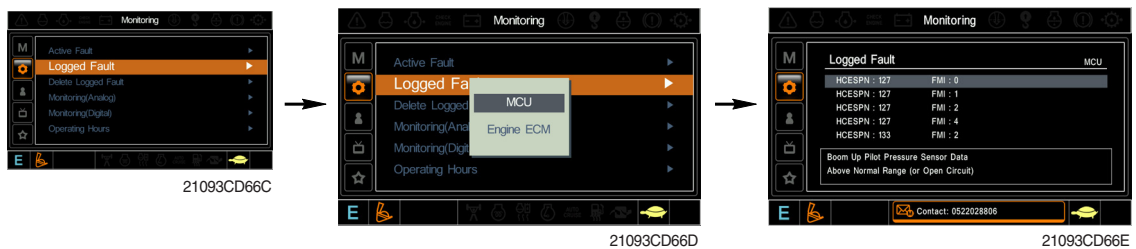

- The logged faults of the MCU or engine ECM can be checked by this menu.

3) Delete fault



- The logged faults of the MCU or engine ECM can be deleted by this menu.

3. MACHINE ERROR CODES TABLE

Error code		Description
HCESPN	FMI	
101	3	Hydraulic oil temperature sensor circuit - Voltage above normal, or shorted to high source.
	4	Hydraulic oil temperature circuit - Voltage below normal, or shorted to low source.
105	0	Working pressure sensor data above normal range.
	1	Working pressure sensor data below normal range.
	2	Working pressure sensor data error.
	4	Working pressure sensor circuit - Voltage below normal, or shorted to Low source.
108	0	Travel oil pressure sensor data above normal range.
	1	Travel oil pressure sensor data below normal range.
	2	Travel oil pressure sensor data error.
	4	Travel oil pressure sensor circuit - Voltage below normal, or shorted to low source.
120	0	Main pump 1 (P1) pressure sensor data above normal range.
	1	Main pump 1 (P1) pressure sensor data below normal range.
	2	Main pump 1 (P1) pressure sensor data error.
	4	Main pump 1 (P1) pressure sensor circuit - Voltage below normal, or shorted to low source.
121	0	Main pump 2 (P2) pressure sensor data above normal range.
	1	Main pump 2 (P2) pressure sensor data below normal range.
	2	Main pump 2 (P2) pressure sensor data error.
	4	Main pump 2 (P2) pressure sensor circuit - Voltage below normal, or shorted to low source.
122	0	Overload pressure sensor data above normal range.
	1	Overload pressure sensor data below normal range.
	2	Overload pressure sensor data error.
	4	Overload pressure sensor circuit - Voltage below normal, or shorted to low source.
123	0	Negative 1 pressure sensor data above normal range.
	1	Negative 1 pressure sensor data below normal range.
	2	Negative 1 pressure sensor data error.
	4	Negative 1 pressure sensor circuit - Voltage below normal, or shorted to low source.
124	0	Negative 2 Pressure sensor data above normal range.
	1	Negative 2 Pressure sensor data below normal range.
	2	Negative 2 Pressure sensor data error.
	4	Negative 2 Pressure sensor circuit - Voltage below normal, or shorted to low source.
125	0	Pilot pump (P3) pressure sensor data above normal range.
	1	Pilot pump (P3) pressure sensor data below normal range.
	2	Pilot pump (P3) pressure sensor data error.
	4	Pilot pump (P3) pressure sensor circuit - Voltage below normal, or shorted to low source.
127	0	Boom up pilot pressure sensor data above normal range.
	1	Boom up pilot pressure sensor data below normal range.
	2	Boom up pilot pressure sensor data error.
	4	Boom up pilot pressure sensor circuit - Voltage below normal, or shorted to low source.
133	0	Arm in/out & bucket in pilot pressure sensor data above normal range.
	1	Arm in/out & bucket in pilot pressure sensor data below normal range.
	2	Arm in/out & bucket in pilot pressure sensor data error.
	4	Arm in/out & bucket in pilot pressure sensor circuit - Voltage below normal, or shorted to low source.

Error code		Description
HCESPN	FMI	
135	0	Swing pilot pressure sensor data above normal range.
	1	Swing pilot pressure sensor data below normal range.
	2	Swing pilot pressure sensor data error.
	4	Swing pilot pressure sensor circuit - Voltage below normal, or shorted to low source.
138	0	Attachment pilot pressure sensor data above normal range.
	1	Attachment pilot pressure sensor data below normal range.
	2	Attachment pilot pressure sensor data error.
	4	Attachment pilot pressure sensor circuit - Voltage below normal, or shorted to low source.
140	5	Pump EPPR valve circuit - Current below normal, or open circuit.
	6	Pump EPPR valve circuit - Current above normal.
141	5	Boom priority EPPR valve circuit - Current below normal, or open circuit.
	6	Boom priority EPPR valve circuit - Current above normal.
143	5	Travel EPPR valve circuit - Current below normal, or open circuit.
	6	Travel EPPR valve circuit - Current above normal.
144	5	Attachment flow EPPR valve circuit - Current below normal, or open circuit.
	6	Attachment flow EPPR valve circuit - Current above normal.
145	5	Remote cooling fan EPPR valve circuit - Current below normal, or open circuit.
	6	Remote cooling fan EPPR valve circuit - Current above normal.
150	5	Left rotate EPPR valve circuit - Current below normal, or open circuit.
	6	Left rotate EPPR valve circuit - Current above normal.
151	5	Right rotate EPPR valve circuit - Current below normal, or open circuit.
	6	Right rotate EPPR valve circuit - Current above normal.
152	5	Left tilt EPPR valve circuit - Current below normal, or open circuit.
	6	Left tilt EPPR valve circuit - Current above normal.
153	5	Right tilt EPPR valve circuit - Current below normal, or open circuit.
	6	Right tilt EPPR valve circuit - Current above normal.
166	5	Power max solenoid circuit - Current below normal, or open circuit.
	6	Power max solenoid circuit - Current above normal.
167	5	Travel speed solenoid circuit - Current below normal, or open circuit.
	6	Travel speed solenoid circuit - Current above normal.
168	5	Attachment pressure solenoid circuit - Current below normal, or open circuit.
	6	Attachment pressure solenoid circuit - Current above normal.
169	5	Attachment conflux solenoid circuit - Current below normal, or open circuit.
	6	Attachment conflux solenoid circuit - Current above normal.
170	5	Arm regeneration solenoid circuit - Current below normal, or open circuit.
	6	Arm regeneration solenoid circuit - Current above normal.
171	5	Attachment safety solenoid circuit - Current below normal, or open circuit.
	6	Attachment safety solenoid circuit - Current above normal.
181	5	Remote cooling fan reverse solenoid circuit - Current below normal, or open circuit.
	6	Remote cooling fan reverse solenoid circuit - Current above normal.
301	3	Fuel level sensor circuit - Voltage above normal, or shorted to high source.
	4	Fuel level sensor circuit - Voltage below normal, or shorted to low source.
304	3	Engine coolant temperature sensor circuit - Voltage above normal, or shorted to high source.
	4	Engine coolant temperature sensor circuit - Voltage below normal, or shorted to low source.
310	8	Engine speed signal error - Abnormal frequency or pulse width.
322	3	Engine preheat relay circuit - Voltage above normal, or shorted to high source.
	4	Engine preheat relay circuit - Voltage below normal, or shorted to low source.
325	3	Fuel warmer relay circuit - Voltage above normal, or shorted to high source.
	4	Fuel warmer relay circuit - Voltage below normal, or shorted to low source.

Error code		Description
HCESPN	FMI	
340	3	Potentiometer (G/A) circuit - Voltage above normal, or shorted to high source.
	4	Potentiometer (G/A) circuit - Voltage below normal, or shorted to low source.
341	5	Governor actuator circuit - Current below normal, or open circuit.
	6	Governor actuator circuit - Current above normal.
501	0	Transmission oil pressure sensor data above normal range.
	1	Transmission oil pressure sensor data below normal range.
	2	Transmission oil pressure sensor data error.
	4	Transmission oil pressure sensor circuit - Voltage below normal, or shorted to low source.
503	0	Brake pressure sensor data above normal range.
	1	Brake pressure sensor data below normal range.
	2	Brake pressure sensor data error.
	4	Brake pressure sensor circuit - Voltage below normal, or shorted to low source.
505	0	Working brake pressure sensor data above normal range.
	1	Working brake pressure sensor data below normal range.
	2	Working brake pressure sensor data error.
	4	Working brake pressure sensor circuit - Voltage below normal, or shorted to low source.
506	3	Working brake lamp circuit - Voltage above normal, or shorted to high source.
	4	Working brake lamp circuit - Voltage below normal, or shorted to low source.
520	3	Ram lock lamp circuit - Voltage above normal, or shorted to high source.
	4	Ram lock lamp circuit - Voltage below normal, or shorted to low source.
525	5	Ram lock solenoid circuit - Current below normal, or open circuit.
	6	Ram lock solenoid circuit - Current above normal.
530	0	Travel F pilot pressure sensor data above normal range.
	1	Travel F pilot pressure sensor data below normal range.
	2	Travel F pilot pressure sensor data error.
	4	Travel F pilot pressure sensor circuit - Voltage below normal, or shorted to low source.
531	0	Travel R pilot pressure sensor data above normal range.
	1	Travel R pilot pressure sensor data below normal range.
	2	Travel R pilot pressure sensor data error.
	4	Travel R pilot pressure sensor circuit - Voltage below normal, or shorted to low source.
701	3	Hourmeter circuit - Voltage above normal, or shorted to high source.
	4	Hourmeter circuit - Voltage below normal, or shorted to low source.
705	0	MCU input voltage high.
	1	MCU input voltage low.
707	1	Alternator node I voltage low.
714	3	Acc. dial circuit - Voltage above normal, or shorted to high source.
	4	Acc. dial circuit - Voltage below normal, or shorted to low source.
715	3	Rotate signal input circuit - Voltage above normal, or shorted to high source.
	4	Rotate signal input circuit - Voltage below normal, or shorted to low source.
716	3	Tilt signal input circuit - Voltage above normal, or shorted to high source.
	4	Tilt signal input circuit - Voltage below normal, or shorted to low source.
722	3	Travel alarm (buzzer) circuit - Voltage above normal, or shorted to high source.
	4	Travel alarm (buzzer) circuit - Voltage below normal, or shorted to low source.
830	12	MCU internal memory error.
840	2	Cluster communication data error.
841	2	ECM communication data error.
843	2	Option #1 (CAN 2) communication data error.
850	2	RMCU communication data error.

4. ENGINE FAULT CODE

SPN	FMI	Fault code No.	Description
91	2	SPN91-FMI2	Throttle Position Sensor Data Erratic, Intermittent, or Incorrect
	3	SPN91-FMI3	(Secondary) Throttle Position Sensor Voltage Above Normal or Shorted High
	4	SPN91-FMI4	(Secondary) Throttle Position Sensor Voltage Below Normal or Shorted Low
	8	SPN91-FMI8	(Secondary) Throttle Position Sensor Abnormal Frequency or Period
	12	SPN91-FMI12	(Secondary) Throttle Position Sensor Bad Device or Component
100	1	SPN100-FMI1	Engine Oil pressure Low-Warning
	2	SPN100-FMI2	Engine Oil Pressure Low-Derate
	3	SPN100-FMI3	Engine Oil Pressure Sensor Voltage Above Normal or Shorted High(Shutdown)
	4	SPN100-FMI4	Engine Oil Pressure Sensor Voltage Below Normal or Shorted Low
105	10	SPN100-FMI10	Engine Oil Pressure Sensor 5V Supply Connection Open Circuit
	1	SPN105-FMI1	Inlet Manifold Air Temp High-Warning
	2	SPN105-FMI2	Inlet Manifold Air Temp High-Derate
	3	SPN105-FMI3	Inlet Manifold Air Temp Sensor Voltage Above Normal or Shorted High
	4	SPN105-FMI4	Inlet Manifold Air Temp Sensor Voltage Below Normal or Shorted Low
106	3	SPN106-FMI3	Inlet Manifold Pressure Sensor Voltage Above Normal or Shorted High
	4	SPN106-FMI4	Inlet Manifold Pressure Sensor Voltage Below Normal or Shorted Low
	10	SPN106-FMI10	Inlet Manifold Pressure Sensor 5V Supply Connection Open Circuit
110	1	SPN110-FMI1	Engine Coolant Temp High-Warning
	2	SPN110-FMI2	Engine Coolant Temp High-Derate
	3	SPN110-FMI3	Engine Coolant Temp Sensor Voltage Above Normal or Shorted High(Shutdown)
	4	SPN110-FMI4	Engine Coolant Temp Sensor Voltage Below Normal or Shorted Low
157	3	SPN157-FMI3	Fuel Rail Pressure Sensor Voltage Above Normal or Shorted High
	4	SPN157-FMI4	Fuel Rail Pressure Sensor Voltage Below Normal or Shorted Low
157	2	SPN158-FMI2	Keyswitch Data Erratic, Intermittent, or Incorrect
168	0	SPN168-FMI0	Engine ECM Battery Power Excessive
	1	SPN168-FMI1	Engine ECM Battery Power Low
	2	SPN168-FMI2	Engine ECM Battery Power Intermittent
190	1	SPN190-FMI1	Engine Overspeed - Warning
	8	SPN190-FMI8	Speed/Timing Sensor Abnormal Signal Frequency
558	2	SPN558-FMI2	(Secondary) Throttle Position Sensor Idle Validation Switch
630	2	SPN630-FMI2	Customer or System Parameters Data Incorrect
631	2	SPN631-FMI2	Engine Software Data Incorrect
637	11	SPN637-FMI11	Primary to Secondary Engine Speed Signal Calibration Fault
639	9	SPN639-FMI9	SAE J1939 Data Link Abnormal Update
646	5	SPN646-FMI5	Turbo Wastegate Solenoid Current Low
	6	SPN646-FMI6	Turbo Wastegate Solenoid Current High
651	5	SPN651-FMI5	Cylinder #1 Injector Current Low

※ SPN : Suspect Parameter Number
 FMI : Failure Mode Identifier

SPN	FMI	Fault code No.	Description
651	6	SPN651-FMI6	Cylinder #1 Injector Current High
	7	SPN651-FMI7	Cylinder #1 Injector Not Responding
652	5	SPN652-FMI5	Cylinder #2 Injector Current Low
	6	SPN652-FMI6	Cylinder #2 Injector Current High
653	7	SPN652-FMI7	Cylinder #2 Injector Not Responding
	5	SPN653-FMI5	Cylinder #3 Injector Current Low
	6	SPN653-FMI6	Cylinder #3 Injector Current High
654	7	SPN653-FMI7	Cylinder #3 Injector Not Responding
	5	SPN654-FMI5	Cylinder #4 Injector Current Low
	6	SPN654-FMI6	Cylinder #4 Injector Current High
655	7	SPN654-FMI7	Cylinder #4 Injector Not Responding
	5	SPN655-FMI5	Cylinder #5 Injector Current Low
	6	SPN655-FMI6	Cylinder #5 Injector Current High
656	7	SPN655-FMI7	Cylinder #5 Injector Not Responding
	5	SPN656-FMI5	Cylinder #6 Injector Current Low
	6	SPN656-FMI6	Cylinder #6 Injector Current High
676	7	SPN656-FMI7	Cylinder #6 Injector Not Responding
	5	SPN676-FMI5	Glow Plug Start Aid Relay Current Low
678	6	SPN676-FMI6	Glow Plug Start Aid Relay Current High
	3	SPN678-FMI3	Engine ECM 8V DC Supply Voltage Above Normal or Shorted High
723	4	SPN678-FMI4	Engine ECM 8V DC Supply Voltage Below Normal or Shorted Low
	8	SPN723-FMI8	Secondary Engine Speed Sensor Abnormal Signal Frequency
1079	3	SPN1079-FMI3	5V Sensor DC Supply Voltage Above Normal or Shorted High
	4	SPN1079-FMI4	5V Sensor DC Supply Voltage Below Normal or Shorted Low
1188	7	SPN1188-FMI7	Turbo Wastegate Not Responding
1347	5	SPN1347-FMI5	Fuel Rail Pump Output Current Low
	6	SPN1347-FMI6	Fuel Rail Pump Output Current High
	7	SPN1347-FMI7	Fuel Rail Pump Output Not Responding

GROUP 12 ENGINE CONTROL SYSTEM

1. MCU and Engine ECM (Electronic Control Module)

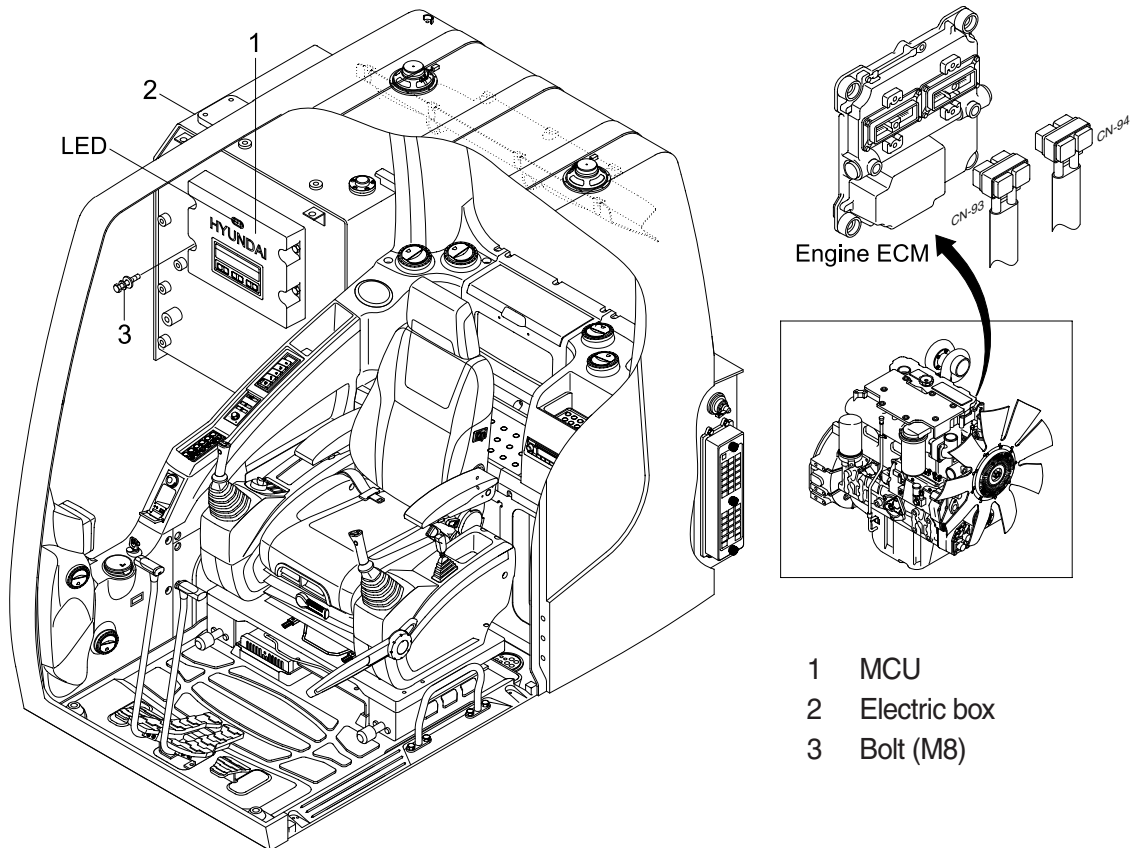

14095MS13

2. MCU ASSEMBLY

- 1) To match the pump absorption torque with the engine torque, MCU varies EPPR valve output pressure, which control pump discharge amount whenever feedbacked engine speed drops under the reference rpm of each mode set.
- 2) Three LED lamps on the MCU display as below.

LED lamp	Trouble	Service
G is turned ON	Normal	-
G and R are turned ON	Trouble on MCU	• Change the MCU
G and Y are turned ON	Trouble on serial communication line	• Check if serial communication lines between controller and cluster are disconnected
Three LED are turned OFF	Trouble on MCU power	• Check if the input power wire (24 V, GND) of controller is disconnected Check the fuse

G : green, R : red, Y : yellow

GROUP 13 EPPR VALVE

1. PUMP EPPR VALVE

1) COMPOSITION

EPPR (Electro Proportional Pressure Reducing) valve consists of electro magnet and spool valve installed at main pump.

(1) Electro magnet valve

Receive electric current from MCU and move the spool proportionally according to the specific amount of electric current value.

(2) Spool valve

Is the two way direction control valve for pilot pressure to reduce main pump flow.

When the electro magnet valve is activated, pilot pressure enters into flow regulator of main pump.

(3) Pressure and electric current value for each mode

Mode		Pressure		Electric current (mA)	Engine rpm (at accel dial 10)
		kgf/cm ²	psi		
Standard (Stage : 1.0)	P	4	57	230 ± 30	2100 ± 50
	S	10 ± 3	142 ± 40	330 ± 30	1900 ± 50
	E	15 ± 3	213 ± 40	400 ± 30	1750 ± 50
Option (Stage : 2.0)	P	0	0	160 ± 30	2100 ± 50
	S	10 ± 3	142 ± 40	330 ± 30	1900 ± 50
	E	15 ± 3	213 ± 40	400 ± 30	1750 ± 50

2) HOW TO SWITCH THE STAGE (1.0 ↔ 2.0) ON THE CLUSTER

You can switch the EPPR valve pressure set by selecting the stage (1.0 ↔ 2.0).

- Management
 - Service menu

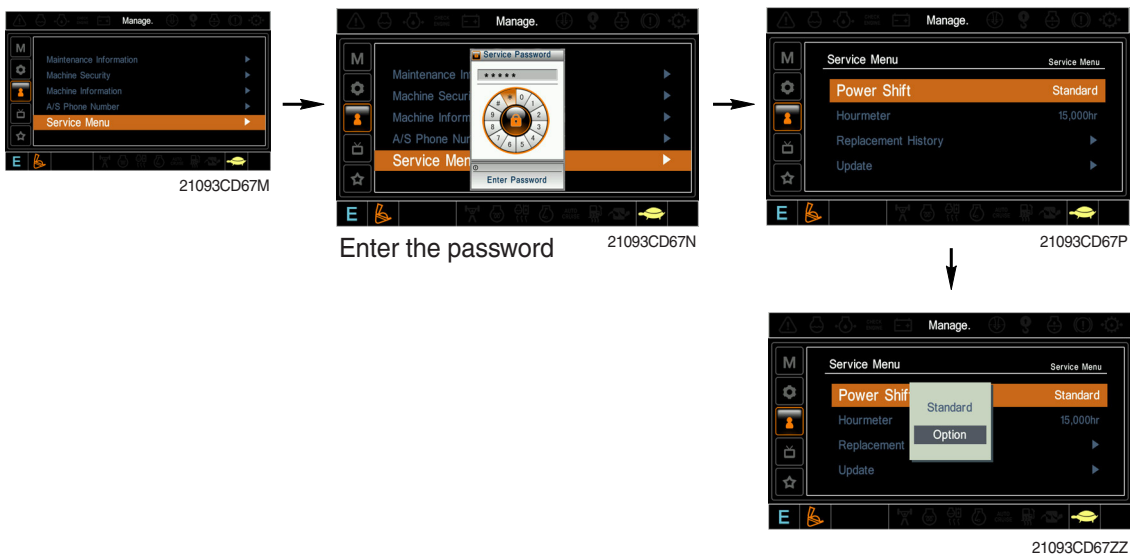

- Power shift (standard/option) : Power shift pressure can be set by option menu.

3) OPERATING PRINCIPLE (pump EPPR valve)

(1) Structure

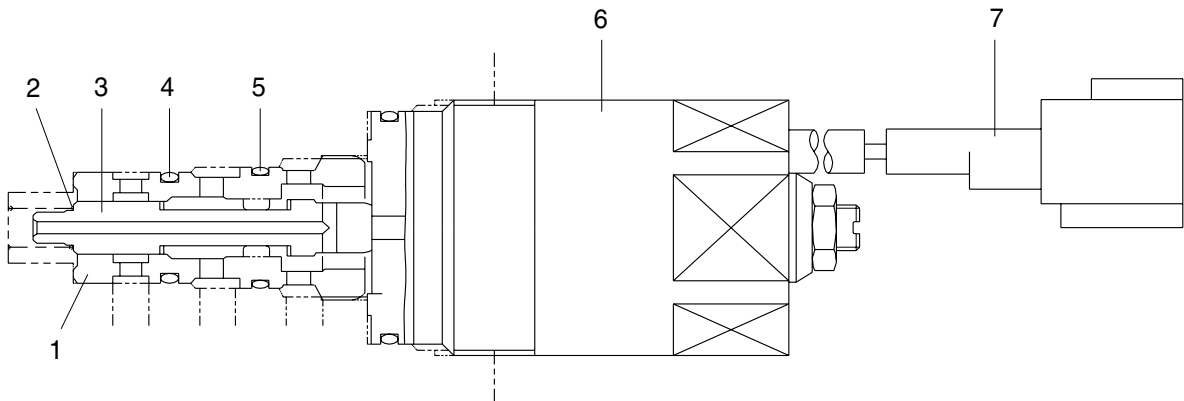

5-22(1)

- 1 Sleeve
- 2 Spring
- 3 Spool

- 4 O-ring
- 5 O-ring

- 6 Solenoid valve
- 7 Connector

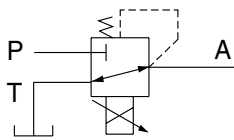

P Pilot oil supply line (pilot pressure)

T Return to tank

A Secondary pressure to flow regulator at main pump

(2) Neutral

Pressure line is blocked and A oil returns to tank.

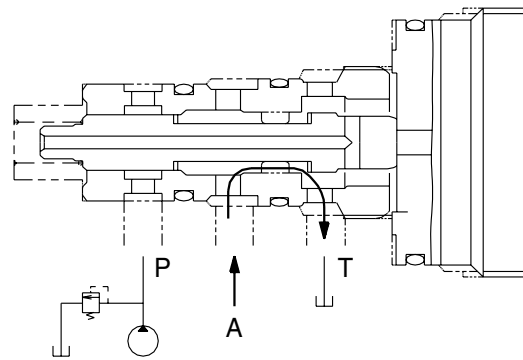
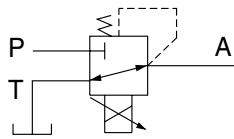

(3) Operating

Secondary pressure enters into A.

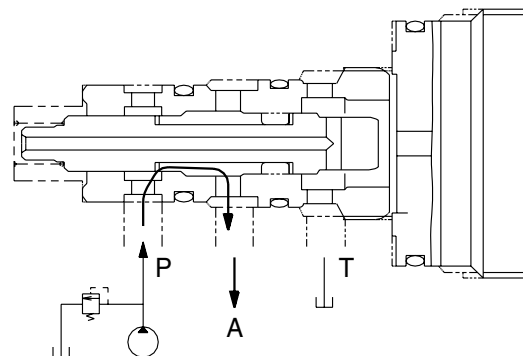
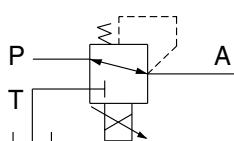

5-22(2)

4) EPPR VALVE CHECK PROCEDURE

(1) Check electric current value at EPPR valve

- ① Disconnect connector CN-75 from EPPR valve.
- ② Insert the adapter to CN-75 and install multimeter as figure.
- ③ Start engine.
- ④ Set S-mode and cancel auto decel mode.
- ⑤ Position the accel dial at 10.
- ⑥ If rpm display show approx 1900 ± 50 rpm check electric current at bucket circuit relief position.

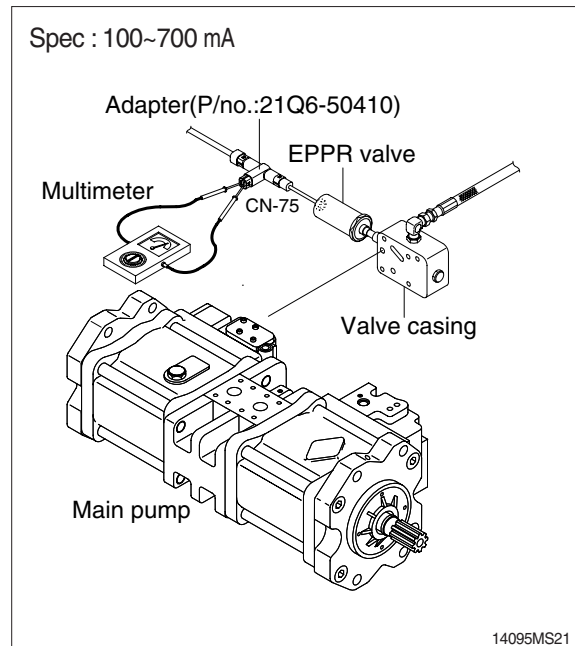

(2) Check pressure at EPPR valve

- ① Remove plug and connect pressure gauge as figure.
 - Gauge capacity : 0 to 50 kgf/cm² (0 to 725 psi)
- ② Start engine.
- ③ Set S-mode and cancel auto decel mode.
- ④ Position the accel dial at 10.
- ⑤ If rpm display approx 1900 ± 50 rpm check pressure at relief position of bucket circuit by operating bucket control lever.
- ⑥ If pressure is not correct, adjust it.
- ⑦ After adjust, test the machine.

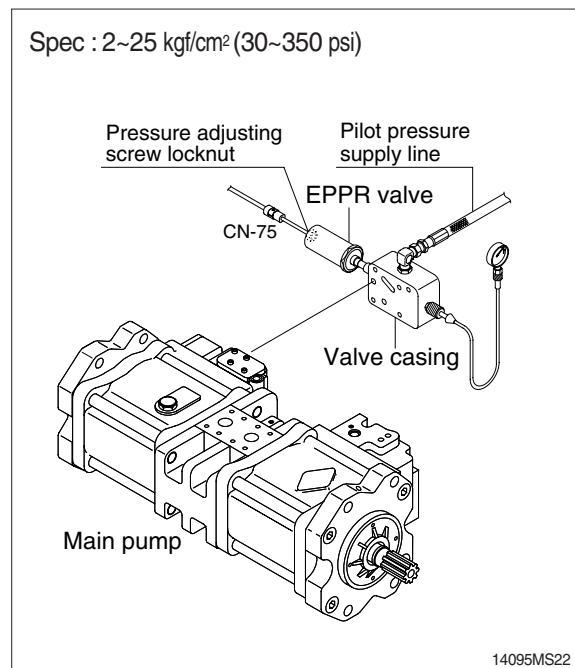

2. BOOM PRIORITY EPPR VALVE

1) COMPOSITION

The boom priority EPPR valve is built in a manifold and mainly consisting of valve body and coil. This EPPR valve installed under the solenoid valve.

2) CONTROL

The boom priority EPPR valve has to be controlled by a specific electronic amplifier card, which is supplying the coil with a current 580 mA at 30 Ω and 24 V.

3) OPERATING PRINCIPLE

(1) Structure

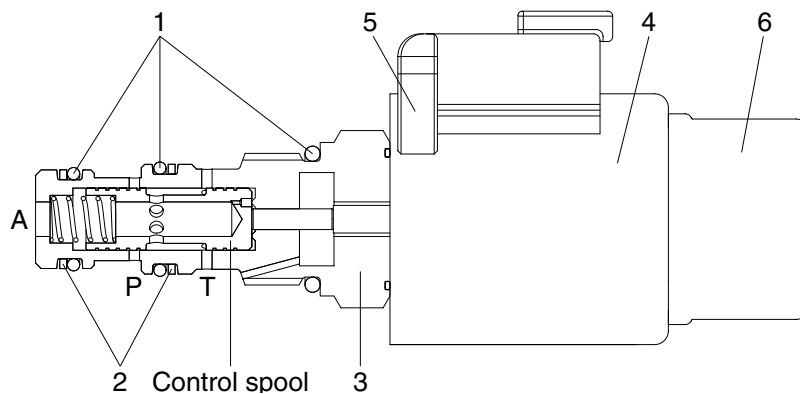

21095MS14

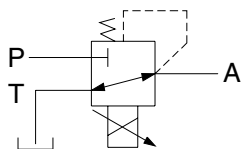

P : Pilot supply line
T : Return to tank
A : Secondary pressure to flow MCV

- | | | | | | |
|---|--------------|---|------------|---|-----------|
| 1 | O-ring | 3 | Valve body | 5 | Connector |
| 2 | Support ring | 4 | Coil | 6 | Cover cap |

(2) Operation

In de-energized mode the inlet port (P) is closed and the outlet port (A) is connected to tank port (T).

In energized mode the solenoid armature presses onto the control spool with a force corresponding to the amount of current. This will set a reduced pressure at port A. The setting is proportional to the amount of current applied.

(3) Maximum pressure relief

If a pressure from outside is applied on port A the valve may directly switch to tank port (T) and protect the system before overload.

2) EPPR VALVE CHECK PROCEDURE

(1) Check electric current value at EPPR valve

- ① Disconnect connector CN-133 from EPPR valve.
- ② Insert the adapter to CN-133 and install multimeter as figure.
- ③ Start engine.
- ④ If rpm display approx 1900 ± 50 rpm check electric current in case of combined boom up and swing operation.

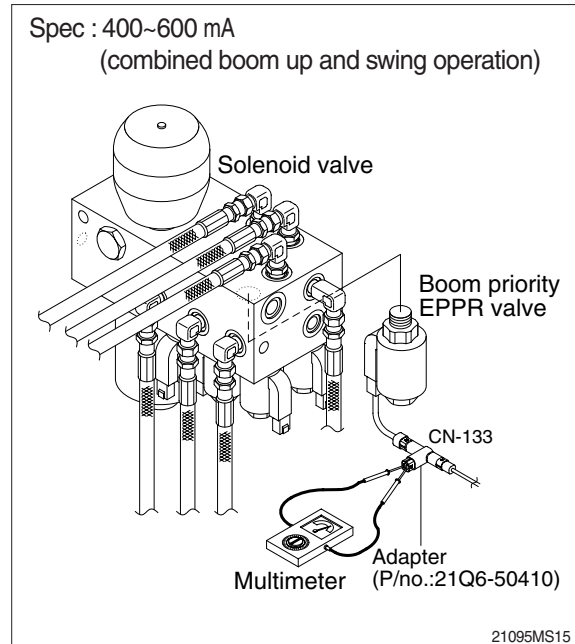

(2) Check pressure at EPPR valve

- ① Remove hose from A5 port and connect pressure gauge as figure.
 - Gauge capacity : 0 to 50 kgf/cm² (0 to 725 psi)
- ② Start engine.
- ③ If rpm display approx 1900 ± 50 rpm check pressure at relief position of bucket circuit by operating bucket control lever.
- ④ If pressure is not correct, adjust it.
- ⑤ After adjust, test the machine.

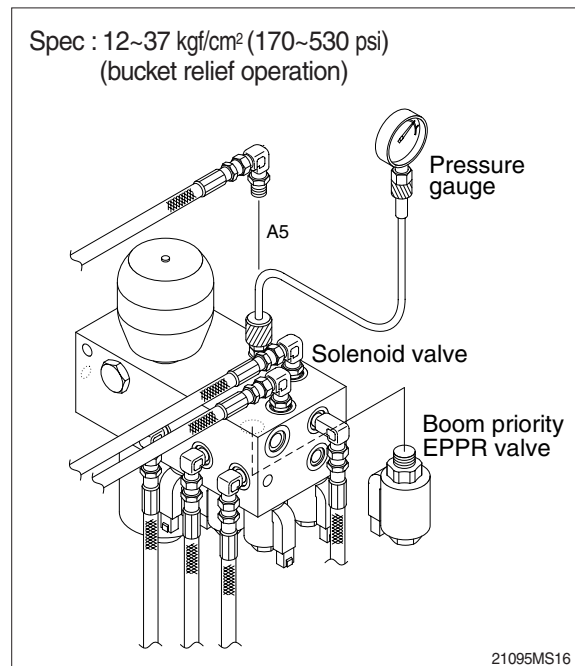

GROUP 14 MONITORING SYSTEM

1. OUTLINE

Monitoring system consists of the monitor part and switch part.

The monitor part gives warnings when any abnormality occurs in the machine and informs the condition of the machine.

Various select switches are built into the monitor panel, which act as the control portion of the machine control system.

2. CLUSTER

1) MONITOR PANEL

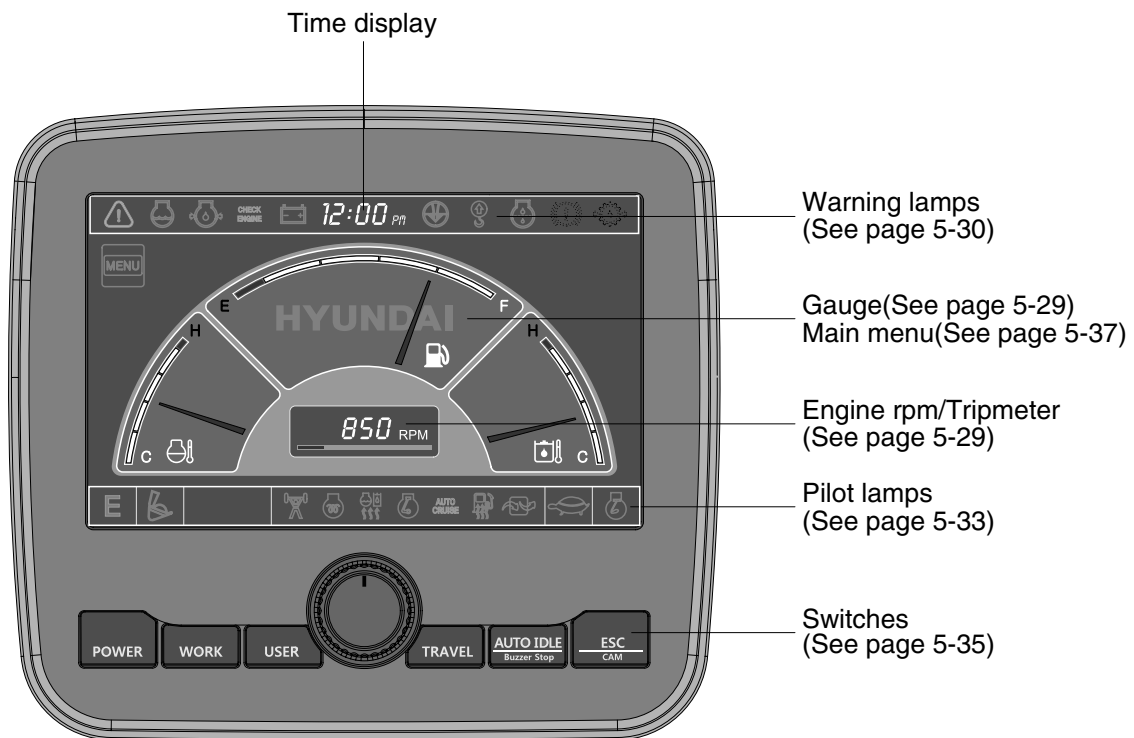

14095MS30

2) CLUSTER CHECK PROCEDURE

(1) Start key : ON

① Check monitor

- a. Buzzer sounding for 4 seconds with HYUNDAI logo on cluster.
- ※ If the ESL mode is set to the enable, enter the password to start engine.

② After initialization of cluster, the operating screen is displayed on the LCD.

Also, self diagnostic function is carried out.

- a. Engine rpm display : 0 rpm
- b. Engine coolant temperature gauge : White range
- c. Hydraulic oil temperature gauge : White range
- d. Fuel level gauge : White range

③ Indicating lamp state

- a. Power mode pilot lamp : E mode or U mode
- b. Work mode pilot lamp : General operation mode (bucket)
- c. Travel speed pilot lamp : Low (turtle)

(2) Start of engine

① Check machine condition

- a. RPM display indicates at present rpm
- b. Gauge and warning lamp : Indicate at present condition.
- ※ When normal condition : All warning lamp OFF
- c. Work mode selection : General work
- d. Power mode selection : E mode or U mode
- e. Travel speed pilot lamp : Low (turtle)

② When warming up operation

- a. Warming up pilot lamp : ON
- b. After engine started, engine speed increases to 1000 rpm.
- ※ Others same as above.

③ When abnormal condition

- a. The warning lamp lights up and the buzzer sounds.
- b. If BUZZER STOP switch is pressed, buzzer sound is canceled but the lamp warning lights up until normal condition.
- ※ The pop-up warning lamp moves to the original position and blink when the select switch is pushed. Also the buzzer stops.

3. CLUSTER CONNECTOR

No.	Name	Signal
1	Battery 24V	20~32V
2	Signal 3	NTSC
3	GND	-
4	Serial + (TX)	0~5V
5	Power IG (24V)	20~32V
6	Signal 2	NTSC
7	Camera signal	NTSC
8	Serial - (RX)	0~5V

※ NTSC : the united states National Television Systems Committee

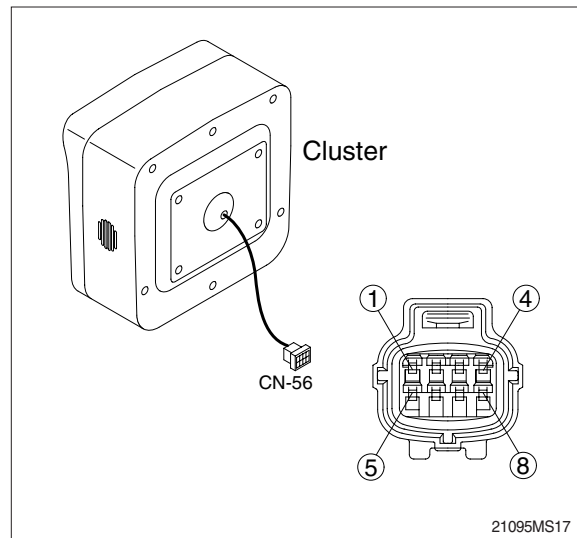

2) GAUGE

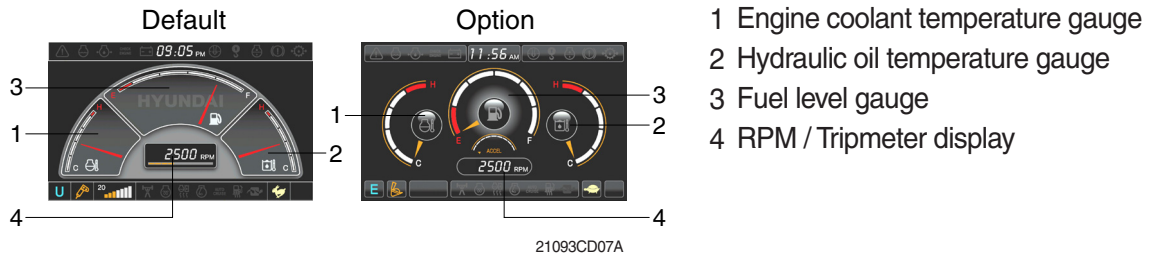

(1) Operation screen



※ Operation screen type can be set by the screen type menu of the display.
Refer to page 5-47 for details.

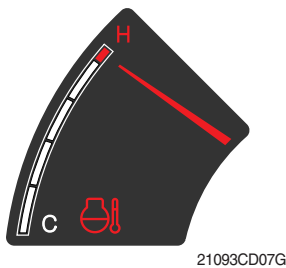

(2) Engine coolant temperature gauge



- ① This gauge indicates the temperature of coolant.
 - White range : 40-107°C (104-225°F)
 - Red range : Above 107°C (225°F)
 - ② If the indicator is in the red range or  lamp blinks in red, turn OFF the engine and check the engine cooling system.
- ※ If the gauge indicates the red range or  lamp blinks in red even though the machine is on the normal condition, check the electric device as that can be caused by the poor connection of electricity or sensor.

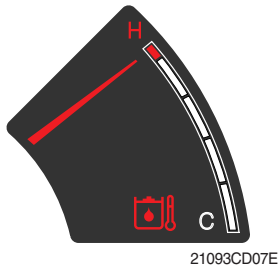

(3) Hydraulic oil temperature gauge

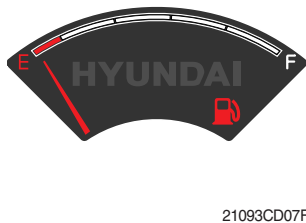

- ① This gauge indicates the temperature of hydraulic oil.
 - White range : 40-105°C(104-221°F)
 - Red range : Above 105°C(221°F)
 - ② If the indicator is in the red range or  lamp blinks is red, reduce the load on the system. If the gauge stays in the red range, stop the machine and check the cause of the problem.
- ※ If the gauge indicates the red range or  lamp blinks in red even though the machine is on the normal condition, check the electric device as that can be caused by the poor connection of electricity or sensor.

(4) Fuel level gauge



- ① This gauge indicates the amount of fuel in the fuel tank.
 - ② Fill the fuel when the red range, or  lamp blinks in red.
- ※ If the gauge indicates the red range or  lamp blinks in red even though the machine is on the normal condition, check the electric device as that can be caused by the poor connection of electricity or sensor.

(5) RPM / Tripmeter display



- ① This displays the engine speed or the tripmeter.
- ※ Refer to page 5-47 for details.

3) WARNING LAMPS

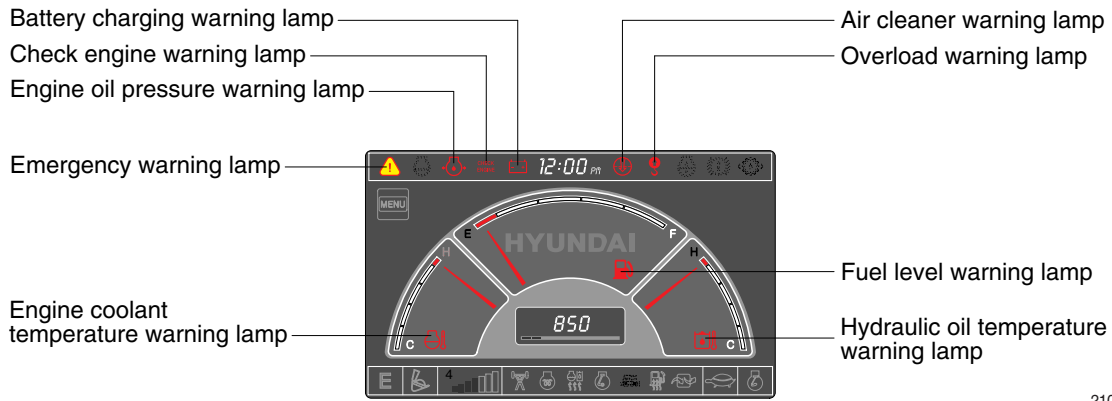

21093CD08D

- ※ Each warning lamp on the top of the LCD pops up on the center of LCD and the buzzer sounds when the each warning is happened. The pop-up warning lamp moves to the original position and blinks when the select switch is pushed. And the buzzer stops. Refer to page 5-36 for the select switch.

(1) Engine coolant temperature

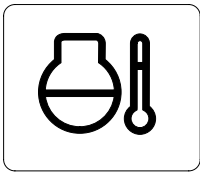

21093CD08A

- ① Engine coolant temperature warning is indicated two steps.
 - 103°C over : The lamp blinks and the buzzer sounds.
 - 107°C over : The lamp pops up on the center of LCD and the buzzer sounds.
- ② The pop-up lamp moves to the original position and blinks when the select switch is pushed. Also, the buzzer stops and lamp keeps blink.
- ③ Check the cooling system when the lamp keeps ON.

(2) Hydraulic oil temperature

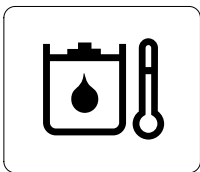

21093CD08C

- ① Hydraulic oil temperature warning is indicated two steps.
 - 100°C over : The lamp blinks and the buzzer sounds.
 - 105°C over : The lamp pops up on the center of LCD and the buzzer sounds.
- ② The pop-up lamp moves to the original position and blinks when the select switch is pushed. Also, the buzzer stops and lamp keeps blink.
- ③ Check the hydraulic oil level and hydraulic oil cooling system.

(3) Fuel level



21093CD08B

- ① This warning lamp blinks and the buzzer sounds when the level of fuel is below 38 l (10.0 U.S. gal).
- ② Fill the fuel immediately when the lamp blinks.

(4) Emergency warning lamp



21093CD30

- ① This lamp pops up and the buzzer sounds when each of the below warnings is happened.
 - Engine coolant overheating (over 107°C)
 - Hydraulic oil overheating (over 105°C)
 - Pump EPPR circuit abnormal or open
 - Attachment flow EPPR circuit abnormal or open
 - MCU input voltage abnormal
 - Accel dial circuit abnormal or open
 - Cluster communication data error
 - Engine ECM communication data error
- ※ **The pop-up warning lamp moves to the original position and blinks when the select switch is pushed. Also the buzzer stops. This is same as following warning lamps.**
- ② When this warning lamp blinks, machine must be checked and serviced immediately.

(5) Engine oil pressure warning lamp

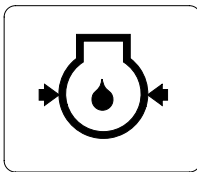

21093CD32

- ① This lamp blinks when the engine oil pressure is low.
- ② If the lamp blinks, shut OFF the engine immediately. Check oil level.

(6) Check engine warning lamp

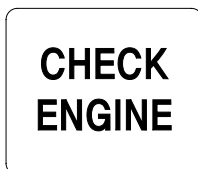

21093CD33



29093CD03

- ① This lamp blinks when the communication between MCU and engine ECM on the engine is abnormal, or if the cluster received any fault code from engine ECM.
- ② Check the communication line between them.
If the communication line is OK, then check the fault codes on the cluster.
- ③ This lamp blinks when "Engine check water in fuel" is displayed in the message box then check water separator.

(7) Battery charging warning lamp

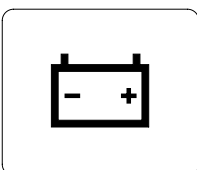

21093CD34

- ① This lamp blinks when the battery charging voltage is low.
- ② Check the battery charging circuit when this lamp blinks.

(8) Air cleaner warning lamp

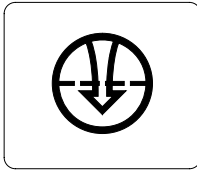

21093CD35

- ① This lamp blinks when the filter of air cleaner is clogged.
- ② Check the filter and clean or replace it.

(9) Overload warning lamp (opt)

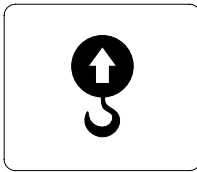

21093CD36





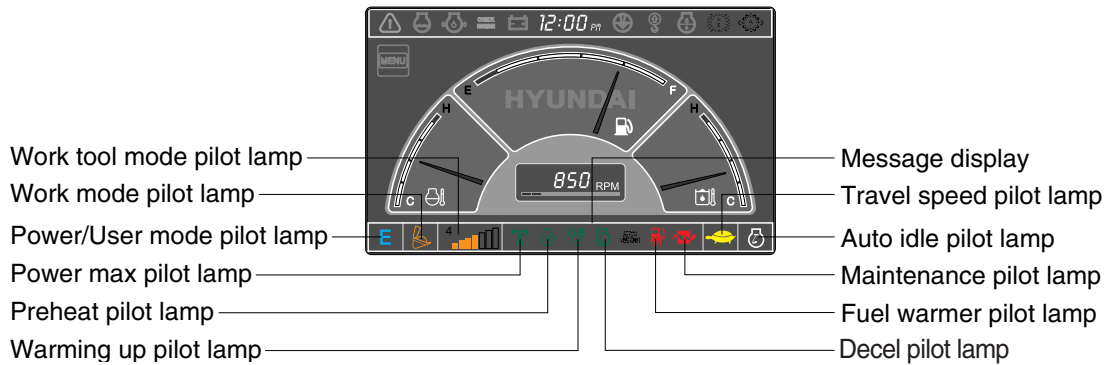







- ① When the machine is overload, the overload warning lamp blinks during the overload switch is ON. (if equipped)
- ② Reduce the machine load.

4) PILOT LAMPS



21093CD09

(1) Mode pilot lamps

No	Mode	Pilot lamp	Selected mode
1	Power mode		Heavy duty power work mode
			Standard power mode
			Economy power mode
2	User mode		User preferable power mode
3	Work mode		General operation mode
			Breaker operation mode
			Crusher operation mode
4	Travel mode		Low speed traveling
			High speed traveling
5	Auto idle mode		Auto idle
6	Work tool mode		Oil flow level of breaker or crusher mode
7	Message display		"Setting is completed" display after selection

(2) Power max pilot lamp



21093CD38

- ① The lamp will be ON when pushing power max switch on the LH RCV lever.
 - ② The power max function is operated maximum 8 seconds.
- ※ Refer to the operator's manual page 3-26 for power max function.

(3) Preheat pilot lamp

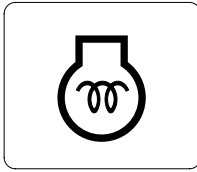

21093CD39

- ① Turning the start key switch ON position starts preheating in cold weather.
- ② Start the engine after this lamp is OFF.

(4) Warming up pilot lamp

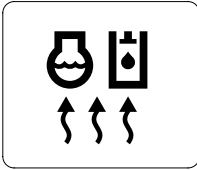

21093CD40

- ① This lamp is turned ON when the coolant temperature is below 30°C (86°F).
- ② The automatic warming up is cancelled when the engine coolant temperature is above 30°C, or when 10 minutes have passed since starting the engine.

(5) Decel pilot lamp



21093CD41

- ① Operating one touch decel switch on the RCV lever makes the lamp ON.
 - ② Also, the lamp will be ON and engine speed will be lowered automatically to save fuel consumption when all levers and pedals are at neutral position, and the auto idle function is selected.
- ※ **One touch decel is not available when the auto idle pilot lamp is turned ON.**
- ※ **Refer to the operator's manual page 3-26.**

(6) Fuel warmer pilot lamp

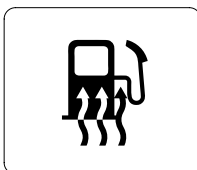

21093CD43

- ① This lamp is turned ON when the coolant temperature is below 10°C (50°F) or the hydraulic oil temperature 20°C (68°F).
- ② The automatic fuel warming is cancelled when the engine coolant temperature is above 60°C, or the hydraulic oil temperature is above 45°C since the start switch was ON position.

(7) Maintenance pilot lamp

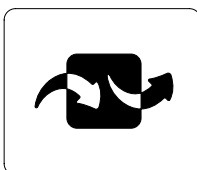

21093CD44

- ① This lamp will be ON when the consuming parts are needed to change or replace. It means that the change or replacement interval of the consuming parts remains below 30 hours.
- ② Check the message in maintenance information of main menu. Also, this lamp lights ON for 3 minutes when the start switch is ON position.

5) SWITCHES

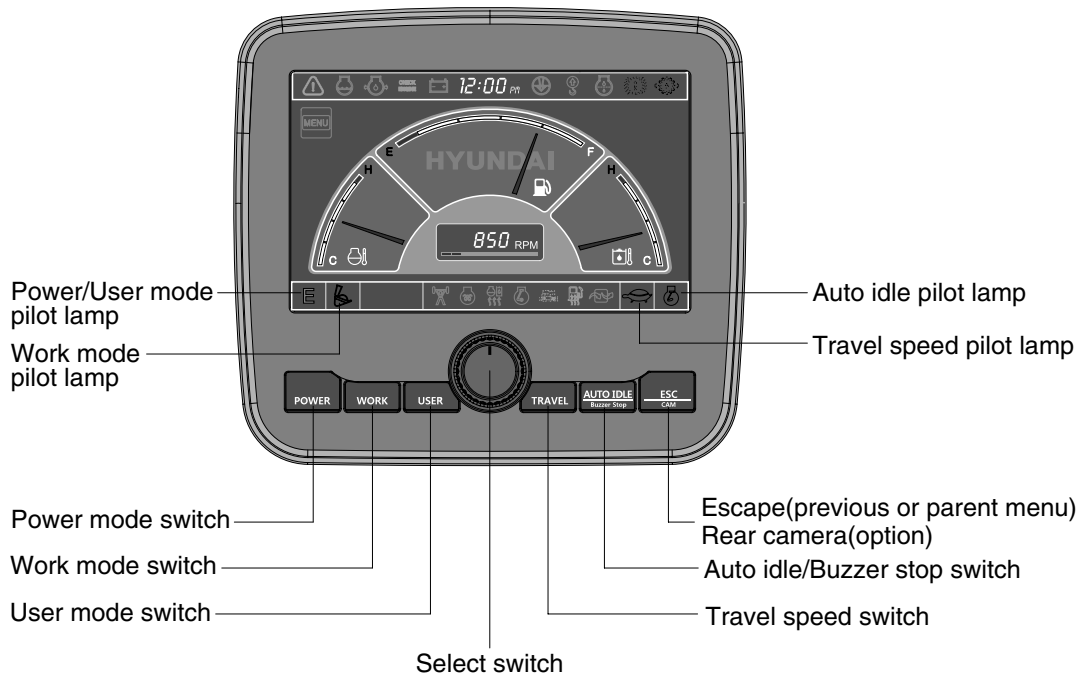

21093CD45

※ When the switches are selected, the pilot lamps are displayed on the LCD. Refer to the page 5-40 for details.

(1) Power mode switch

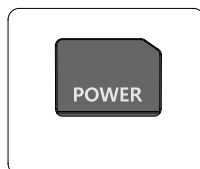



21093CD45A

- ① This switch is to select the machine power mode and selected power mode pilot lamp is displayed on the pilot lamp position.
 - P : Heavy duty power work.
 - S : Standard power work.
 - E : Economy power work.
- ② The pilot lamp changes E → S → P → E in order.

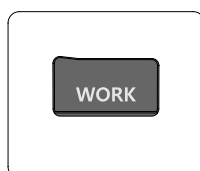
(2) Work mode switch



21093CD45C

- ① This switch is to select the machine work mode, which shifts from general operation mode to optional attachment operation mode.
 -  : General operation mode
 -  : Breaker operation mode (if equipped)
 -  : Crusher operation mode (if equipped)
 - Not installed : Breaker or crusher is not installed.

※ Refer to the operator's manual page 4-6 for details.

(3) User mode switch

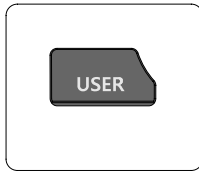

21093CD45D

- ① This switch is used to memorize the current machine operating status in the MCU and activate the memorized user mode.
 - Memory : Push more than 2 seconds.
 - Action : Push within 2 seconds.
 - Cancel : Push this switch once more within 2 seconds.
- ② Refer to the page 5-38 for another set of user mode.

(4) Select switch

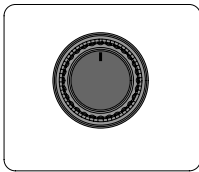

21093CD45E

- ① This switch is used to select or change the menu and input value.
- ② Knob push
 - Long (over 2 sec) : Return to the operation screen
 - Medium (0.5~2 sec) : Return to the previous screen
 - Short (below 0.5 sec) : Select menu
- ③ Knob rotation
This knob changes menu and input value.
 - Right turning : Down direction / Increase input value
 - Left turning : Up direction / Decreased input value

(5) Auto idle/ buzzer stop switch





21093CD45F

- ① This switch is used to activate or cancel the auto idle function.
 - Pilot lamp ON : Auto idle function is activated.
 - Pilot lamp OFF : Auto idle function is cancelled.
- ② The buzzer sounds when the machine has a problem.
In this case, push this switch and buzzer stops, but the warning lamp blinks until the problem is cleared.

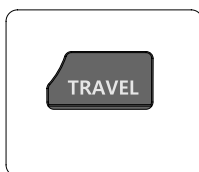
(6) Travel speed control switch



21093CD45G

- ① This switch is used to select the travel speed alternatively.
 -  : High speed
 -  : Low speed

(7) Escape/Camera switch

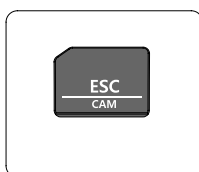

21093CD45H





- ① This switch is used to return to the previous menu or parent menu.
- ② In the operation screen, pushing this switch will display the view of the camera on the machine (if equipped).
Please refer to page 5-48 for the camera.
- ③ If the camera is not installed, this switch is used only ESC function.

6) MAIN MENU



※ Please refer to select switch, page 5-36 for selection and change of menu and input value.

(1) Structure

No	Main menu	Sub menu	Description
1	 Mode 21093CD64D	Work tool U mode power Boom/Arm speed Auto power boost Initial mode Cluster switch (back up)	Breaker, Crusher, Not installed User mode only Boom speed, Arm speed Enable, Disable Default, U mode Switch function
2	 Monitoring 21093CD64E	Active fault Logged fault Delete logged fault Monitoring (analog) Monitoring (digital) Operating hours	MCU, Engine ECM MCU, Engine ECM All logged fault delete, Initialization canceled Machine information Switch status, Output status Operating hours for each mode
3	 Management 21093CD64F	Maintenance information Machine security Machine Information A/S phone number Service menu	Replacement, Change interval oils and filters ESL mode setting, Password change Cluster, MCU, Engine, Machine A/S phone number, A/S phone number change Power shift, Hourmeter, Replacement history, Update
4	 Display 21093CD64G	Display item Clock Brightness Unit Language Screen type	Engine speed, Tripmeter A, Tripmeter B, Tripmeter C Clock Manual, Auto Temperature, Pressure, Flow, Date format Korean, English, Chinese A type, B type
5	 Utilities 21093CD64H	Tripmeter DMB Entertainment Camera setting Message box	3 kinds (A, B, C) DMB select, DAB select, Channel scan, Exit Play MP4, codec. Basic direction, Display switching, Full screen Record for fault, attachment etc.

(2) Mode setup

① Work tool

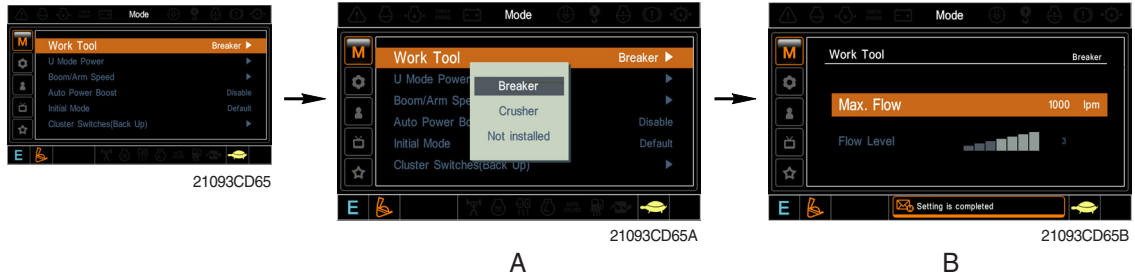

- A : Select one installed optional attachment.
 - B : Max flow - Set the maximum flow for the attachment.
 Flow level - Reduce the operating flow from maximum flow.
 Breaker - Max 7 steps, Reduced 10 lpm each step.
 Crusher - Max 4 steps, Reduced 20 lpm each step.
- ※ The flow level is displayed with the work mode pilot lamp.

② U mode power

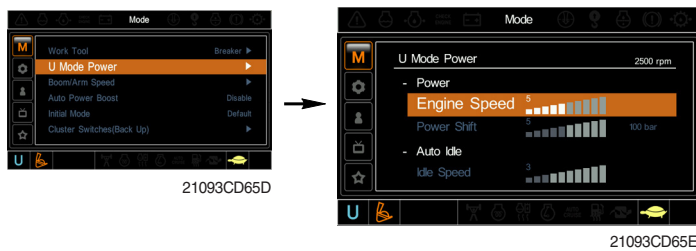

- Engine high idle rpm, auto idle rpm and pump torque (power shift) can be modulated and memorized separately in U-mode.
- U-mode can be activated by user mode switch.

Step (█)	Engine speed (rpm)	Idle speed (rpm)	Power shift (bar)
1	1500	700	0
2	1550	750	2
3	1600	800	4
4	1650	850 (low idle)	7
5	1700	900	12
6	1750	950	15
7	1800	1000 (decel rpm)	20
8	1850	1050	24
9	1900	1100	28
10	1950	1150	33

③ Boom/Arm speed

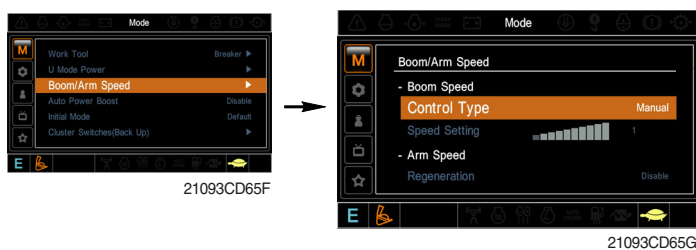

- **Boom speed**
 - Control type
 - Manual - Boom up speed is fixed as set steps.
 - Auto - Boom up speed is automatically adjusted as working conditions by the MCU.
 - Speed setting - Boom up speed is increased as much as activated steps.
- **Arm speed**
 - Regeneration - Arm regeneration function can be activated or cancelled.
 - Enable - Arm in speed is up.
 - Disable - Fine operation.

④ Auto power boost

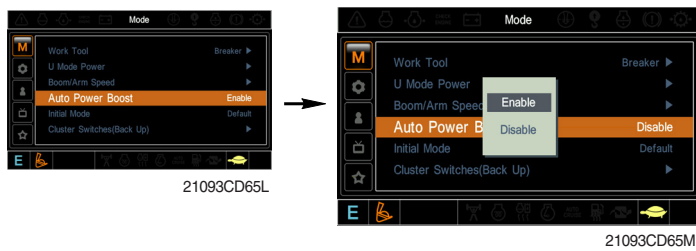

- The power boost function can be activated or cancelled.
- Enable - The digging power is automatically increased as working conditions by the MCU. It is operated max 8 seconds.
- Disable - Not operated.

⑤ Initial mode

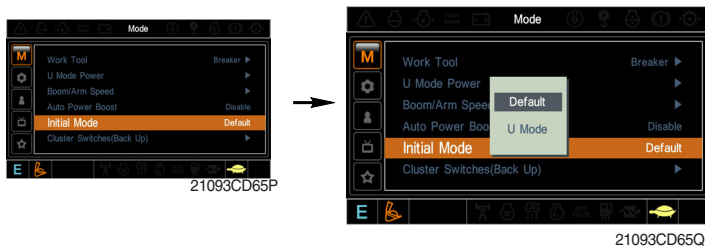

- Default - The initial power mode is set E mode when the engine is started.
- U mode - The initial power mode is set U mode when the engine is started.

⑥ Cluster switch (back up)

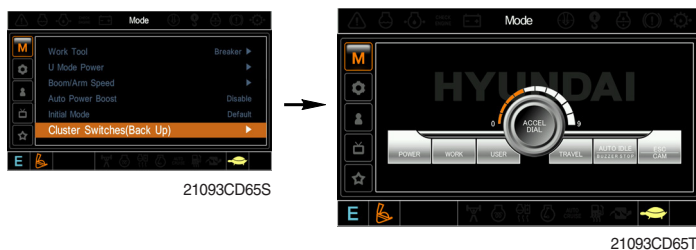

- The cluster switch can be selected and changed by this menu when the switches are abnormal on the cluster.
- In order to exit "Cluster switch" mode, please put the cursor on the ESC/CAM switch by turning the select switch and push the select switch.
- In "Cluster switch", other switches except "Select switch" do not work.

(3) Monitoring

① Active fault

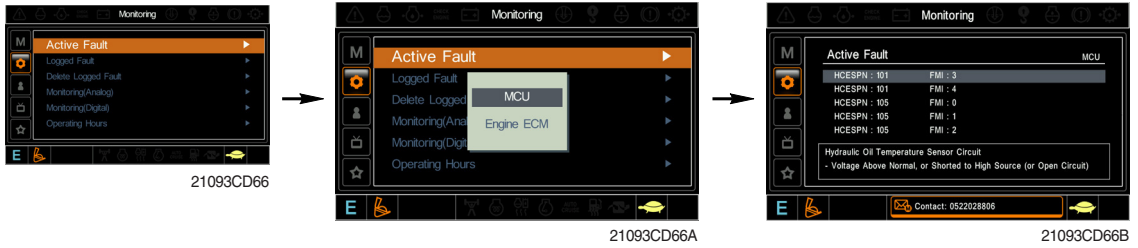

· The active faults of the MCU or engine ECM can be checked by this menu.

② Logged fault

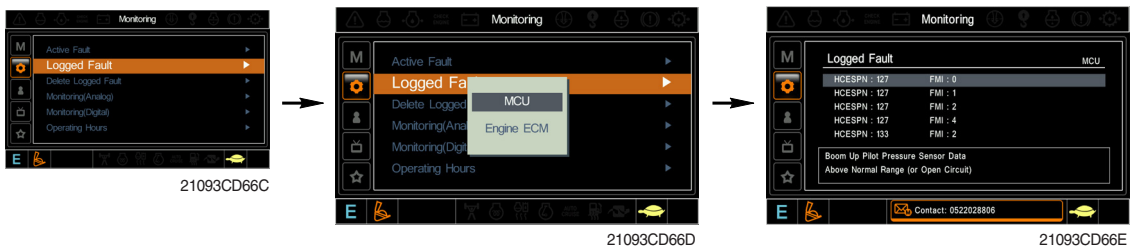

· The logged faults of the MCU or engine ECM can be checked by this menu.

③ Delete logged fault



· The logged faults of the MCU or engine ECM can be deleted by this menu.

④ Monitoring (analog)

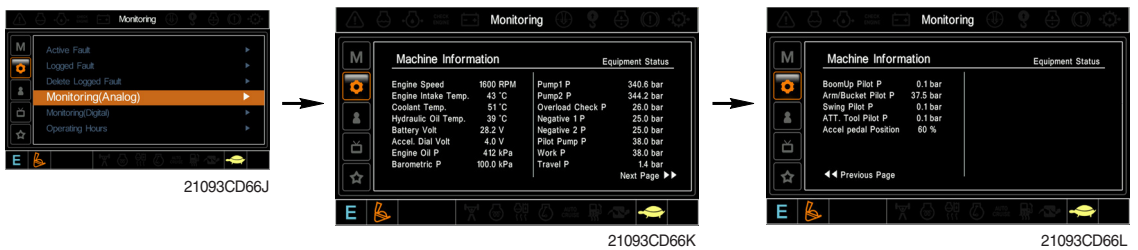

· The machine status such as the engine rpm, oil temperature, voltage and pressure etc. can be checked by this menu.

⑤ Monitoring (digital)

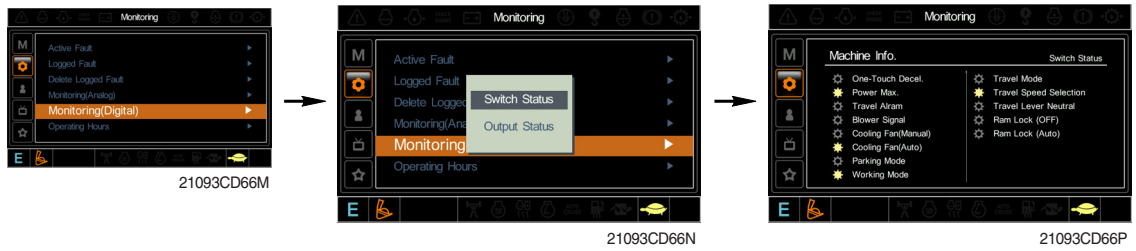

- The switch status or output status can be confirmed by this menu.
- The activated switch or output pilot lamps  are light ON.

⑥ Operating hours

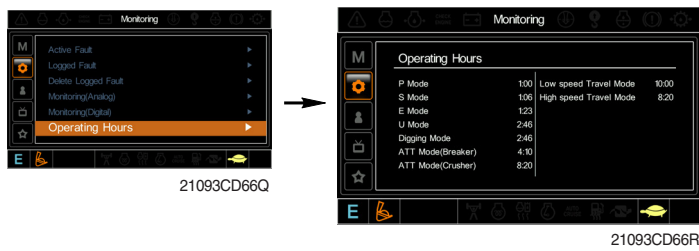

- The operating hour of each mode can be confirmed by this menu.

② Machine security

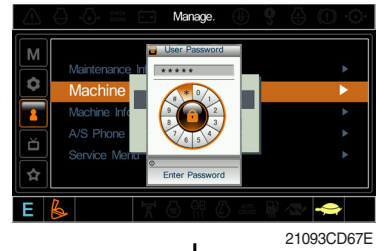
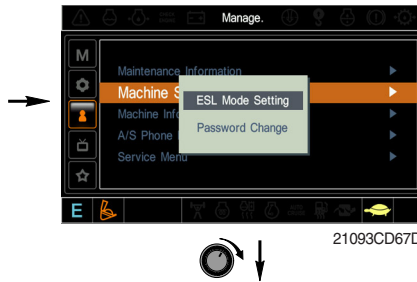
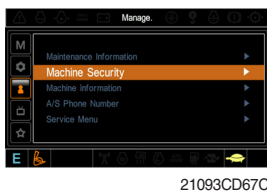

ESL mode

- ESL : Engine Starting Limit
- ESL mode is designed to be a theft deterrent or will prevent the unauthorized operation of the machine.
- If the ESL mode was selected Enable, the password will be required when the start switch is turned ON.
- Disable : Not used ESL function
- Enable (always) : The password is required whenever the operator start engine.
- Enable (interval) : The password is required when the operator start engine first. But the operator can restart the engine within the interval time without inputting the password. The interval time can be set maximum 4 hours.

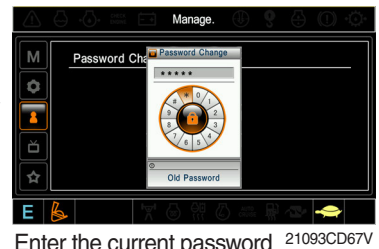
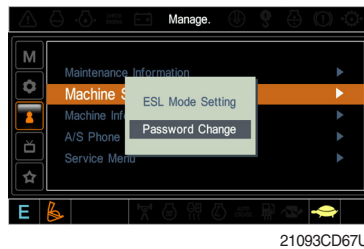
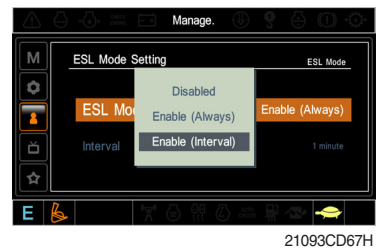
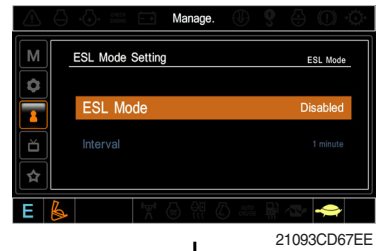

Password change

- The password is 5~10 digits.

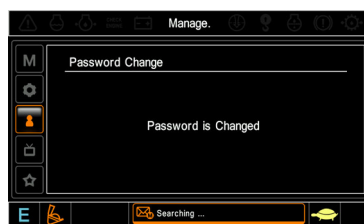
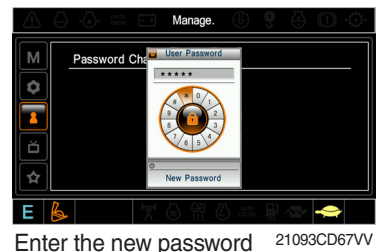

The new password is stored in the MCU.

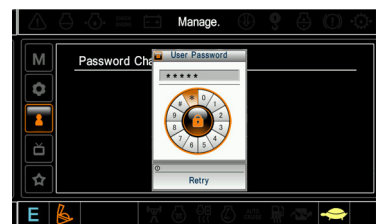

Enter the new password again

③ Machine Information

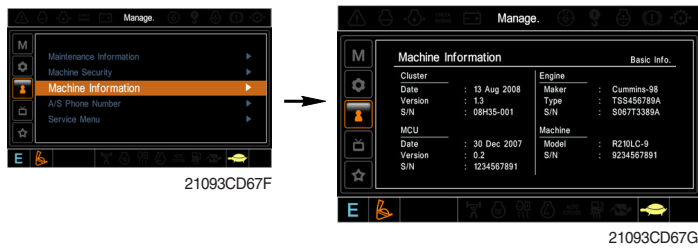

- This can confirm the identification of the cluster, MCU, engine and machine.

④ A/S phone number



⑤ Service menu

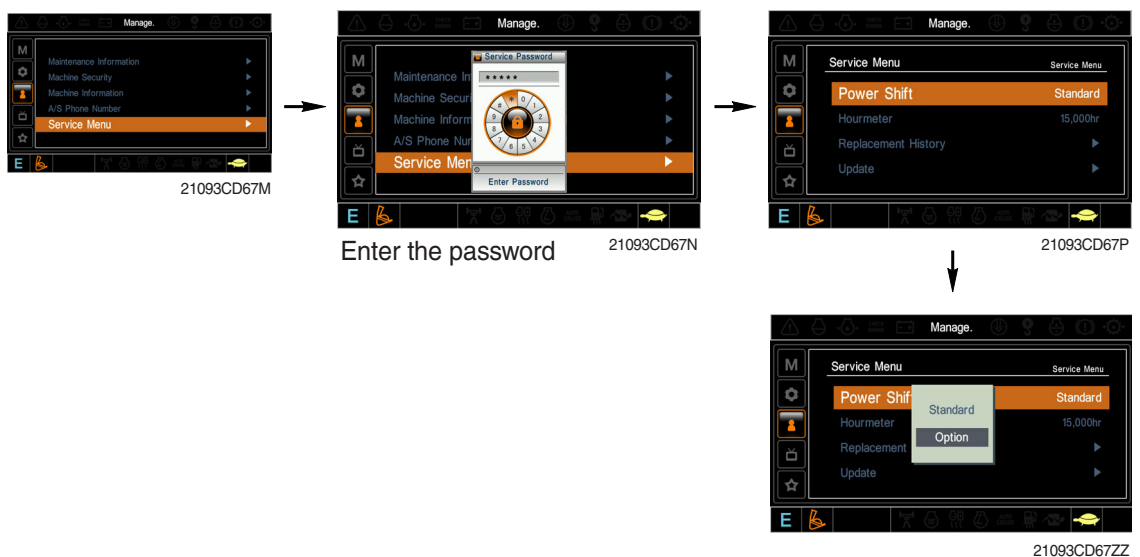

- Power shift (standard/option) : Power shift pressure can be set by option menu.
- Hourmeter : Operating hours since the machine line out can be checked by this menu.
- Replacement history : Replacement history of the MCU and cluster can be checked by this menu.
- Update : Firm ware can be upgraded by this menu. (the USB port is located under the cluster)

(5) Display

① Display item

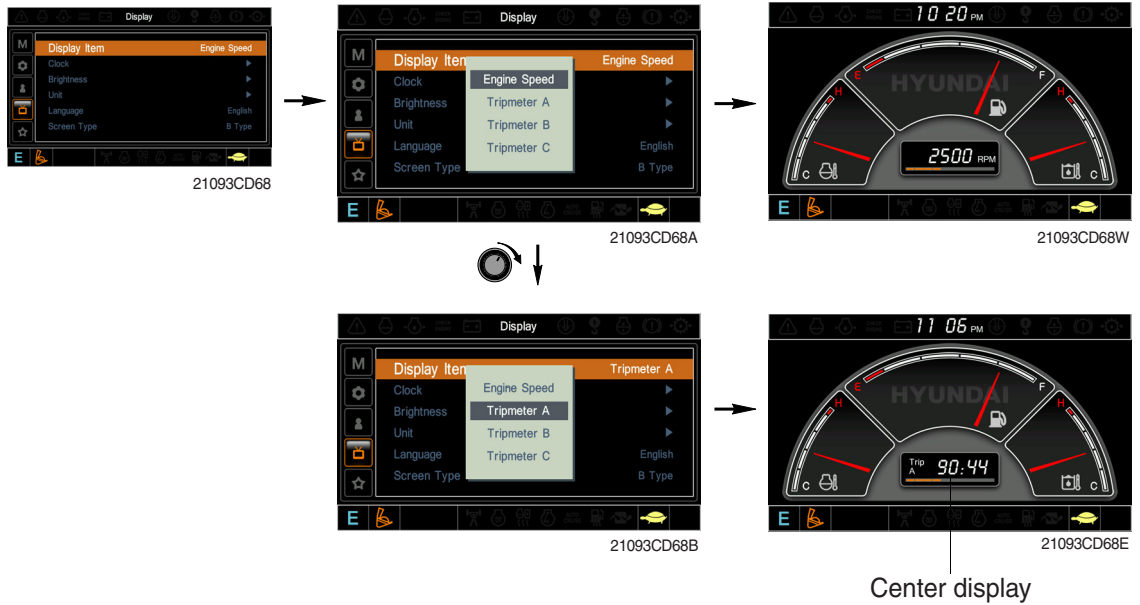

- The center display type of the LCD can be selected by this menu.
- The engine speed or each of the tripmeter (A,B,C) is displayed on the center display.

② Clock

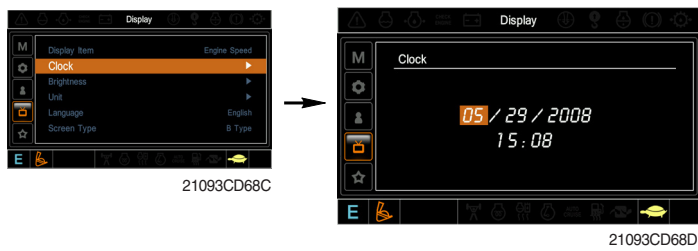

- The first line's three spots "**/**/****" represent Month/Day/Year each.
- The second line shows the current time. (0:00~23:59)

③ Brightness

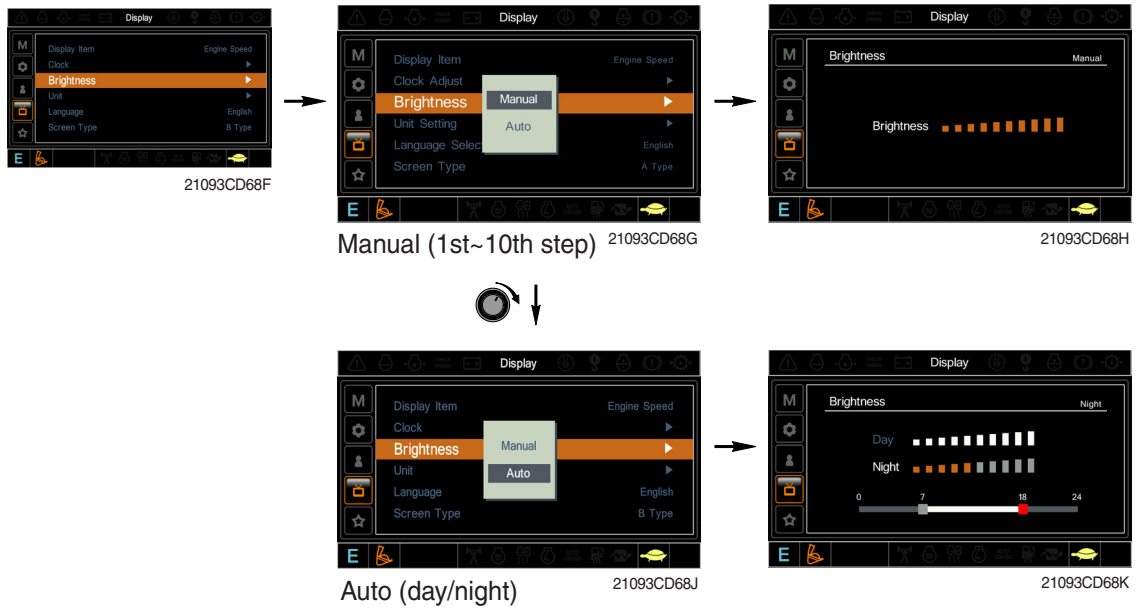

※ If "Auto" is chosen, brightness for day and night can be differently set up. Also by using the bar in lower side, users can define which time interval belongs to day and night. (in bar figure, gray area represents night time while white shows day time)

④ Unit

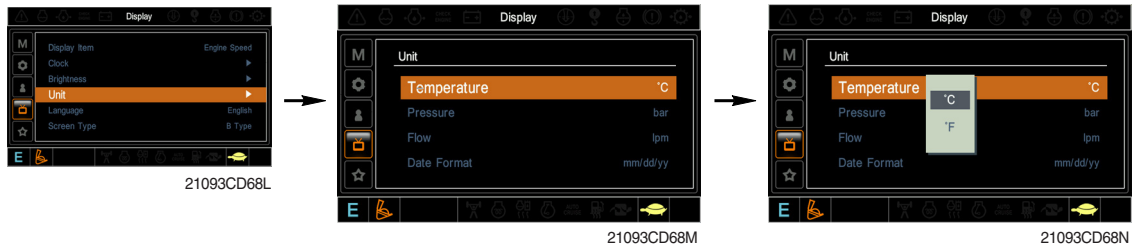

- Temperature : °C ↔ °F
- Pressure : bar ↔ MPa ↔ kgf/cm²
- Flow : lpm ↔ gpm
- Date format : yy/mm/dd ↔ mm/dd/yy ↔ dd-Mar-yy

⑤ Language

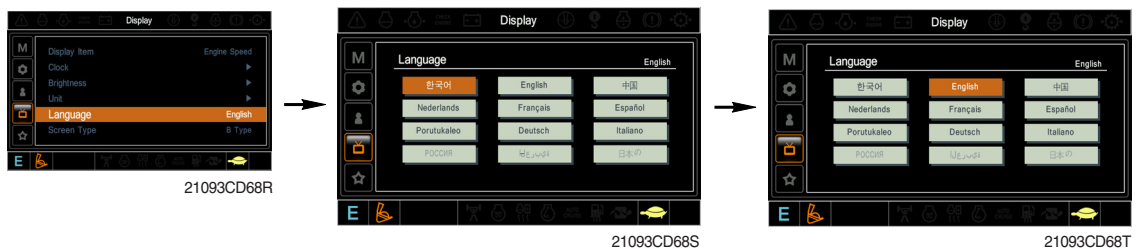

- User can select preferable language and all displays are changed the selected language.

⑥ Screen type

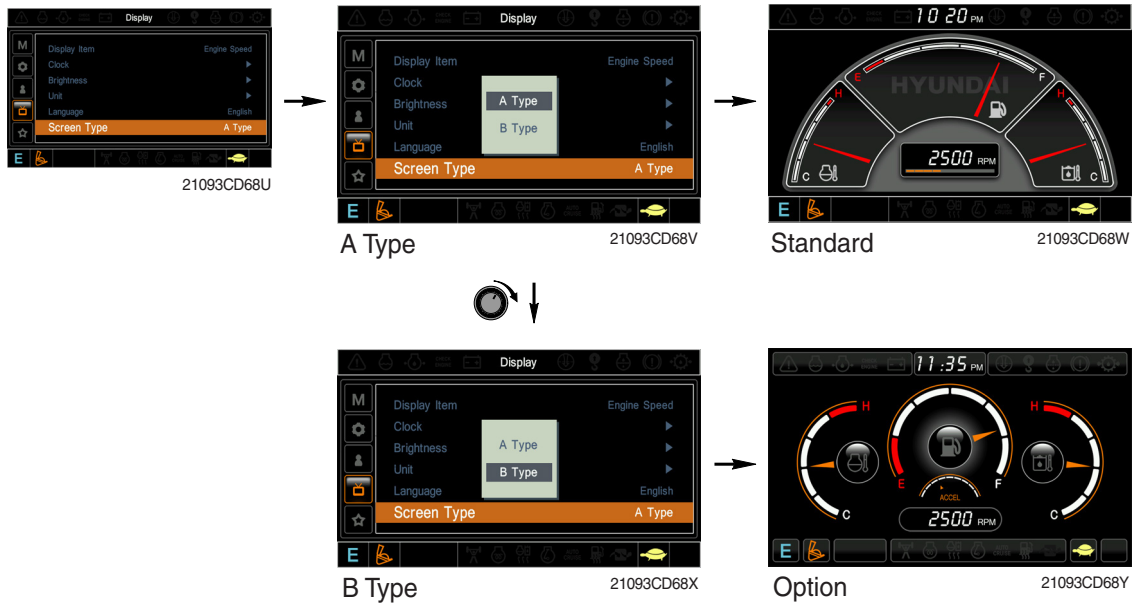

(6) Utilities

① Tripmeter

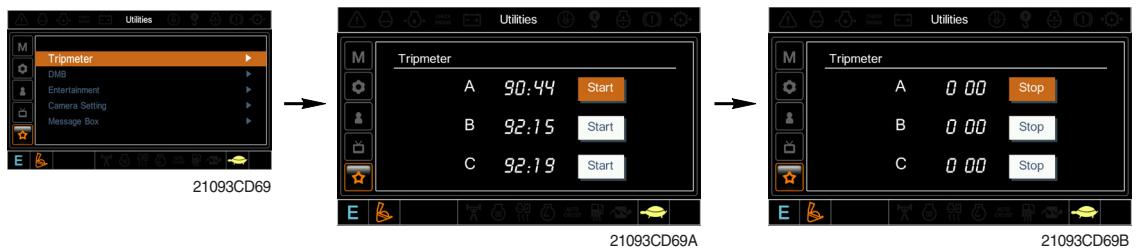

- Maximum 3 kinds of tripmeters can be used at the same time.
- Each tripmeter can be turned on by choosing "Start" while it also can be turned off by choosing "Stop".
- If the tripmeter icon is activated in the operation screen, it can be controlled directly there.

② DMB

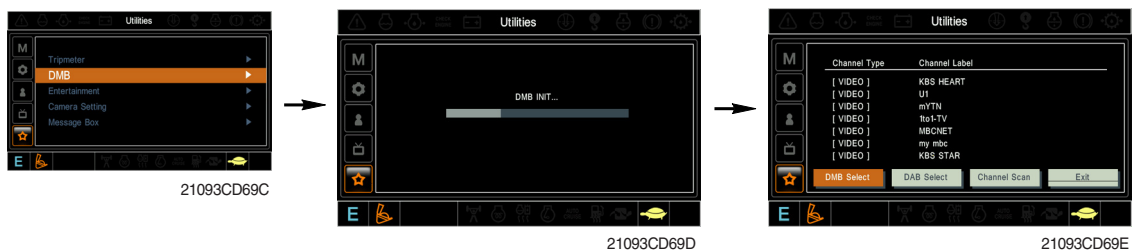

- DMB select : TV channel can be selected by this menu.
- DAB select : Audio channel can be selected by this menu.
- Channel scan : This menu can be used other region for TV/Audio.
- Exit : Exit DMB menu

③ Entertainment

- Play MP4 or codec file of external hard disk through USB port.
- The USB port is located under the cluster.

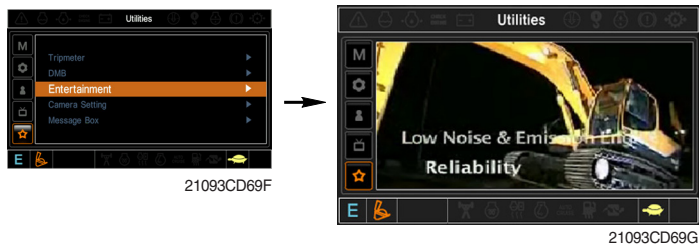

④ Camera setting

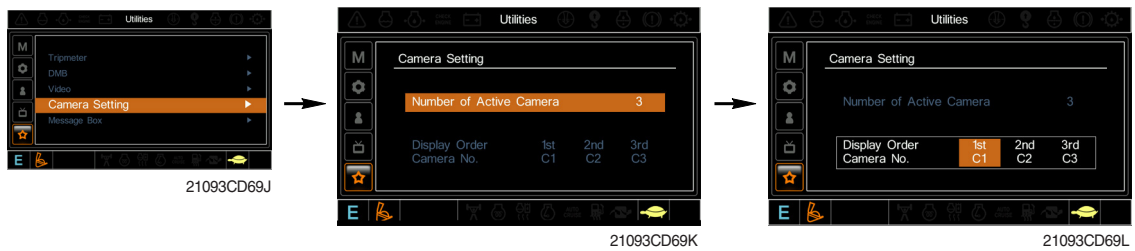

- Three cameras can be installed on the machine.
- The display order can be set by this menu.



- If the camera was not equipped, this menu is not useful.
- In the operation screen, if the ESC/CAM switch is pushed, the first ordered display camera will be viewed.
- Turning the select switch in clockwise direction, the next ordered will be shown and in counter-clockwise direction, the previously ordered will be shown.
- Push the select switch, the displayed screen will be enlargement.

⑤ Message box

- The history of the machine operating status can be checked by this menu.

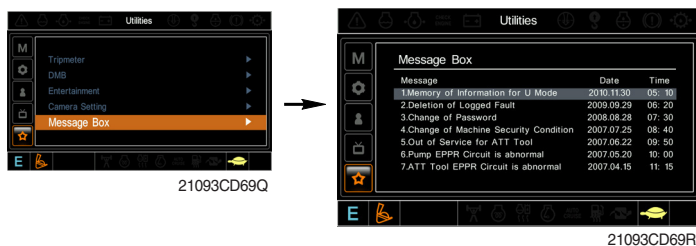

GROUP 15 FUEL WARMER SYSTEM

1. SPECIFICATION

- 1) Operating voltage : 24 ± 4 V
- 2) Power : 350 ± 50 W
- 3) Current : 15 A

2. OPERATION

- 1) The current of fuel warmer system is automatically controlled without thermostat according to fuel temperature.
 - 2) At the first state, the 15 A current flows to the fuel warmer and engine may be started in 1~2 minutes.
 - 3) If the fuel starts to flow, ceramic-disk in the fuel warmer heater senses the fuel temperature to reduce the current as low as 1.5 A.
- So, fuel is protected from overheating by this mechanism.

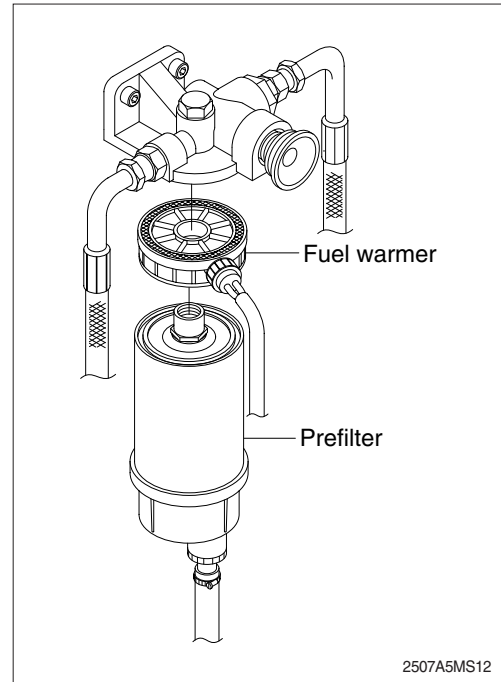

2507A5MS12

3. ELECTRIC CIRCUIT

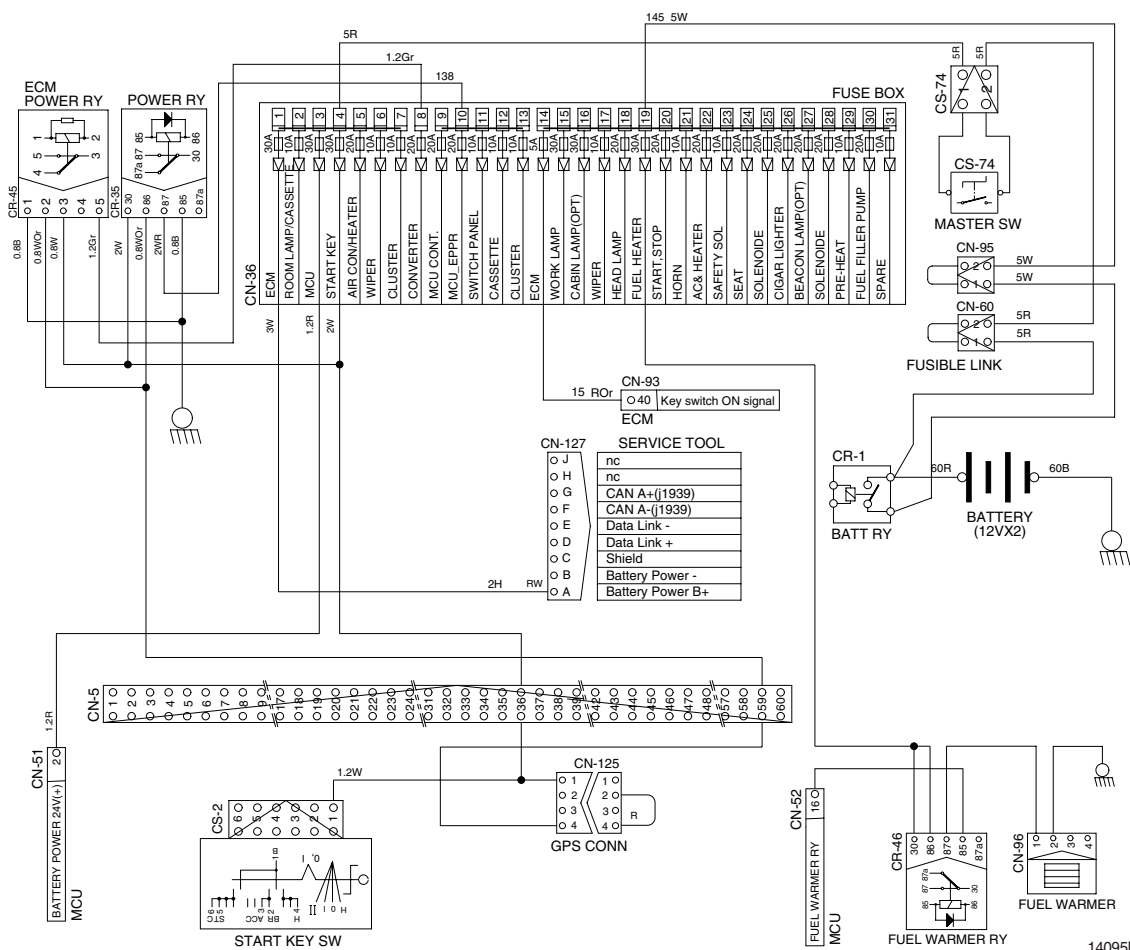

14095MS20