

## 2) CLUSTER CHECK PROCEDURE

### (1) Start key : ON

- ① Check monitor initial 5 seconds
  - a. All lamps light up.
  - b. Buzzer sound.
- ② Check monitor after 5 seconds : Indicate cluster version and machine condition
  - a. Cluster program version : 「1.00」 ← Indicates program version 「1.00」 for 5 seconds.
  - b. Tachometer : 0rpm
  - c. Fuel gauge : All light up below appropriate level
  - d. Hydraulic oil temperature gauge : All light up below appropriate level
  - e. Engine coolant temperature gauge : All light up below appropriate level
  - f. Warning lamp
    - ※ During start key **ON** the engine oil pressure lamp and battery charging lamp go on, but it is not abnormal.
    - ※ When engine coolant temperature below 30°C, the warming up lamp lights up.
- ③ Indicating lamp state
  - a. Work mode selection : General work
  - b. Power mode selection : S mode
  - c. User mode selection : No LED ON
  - d. Auto decel LED : ON
  - e. Travel speed pilot lamp : Low(Turtle)

### (2) Start of engine

- ① Check machine condition
  - a. Tachometer indicates at present rpm
  - b. Gauge and warning lamp : Indicate at present condition.
    - ※ When normal condition : All warning lamp OFF
  - c. Work mode selection : General work
  - d. Power mode selection : S mode
  - e. User mode selection : No LED ON
  - f. Auto decel LED : ON
  - g. Travel speed pilot lamp : Low(Turtle)
- ② When warming up operation
  - a. Warming up lamp : ON
  - b. 10 seconds after engine started, engine speed increases to 1200 rpm (Auto decel LED : ON)
    - ※ Others same as above ①.
- ③ When abnormal condition
  - a. The lamp lights up and the buzzer sounds.
  - b. If **BUZZER STOP** switch is pressed, buzzer sound is canceled but the lamp light up until normal condition.

### 3. CLUSTER CONNECTOR

No.	Signal	Input / Output
1	Power IG(24V)	Input(20~32V)
2	GND	Input(0V)
3	Serial-(RX)	Input(Vpp=12V)
4	Serial+(TX)	Output(Vpp=4V)

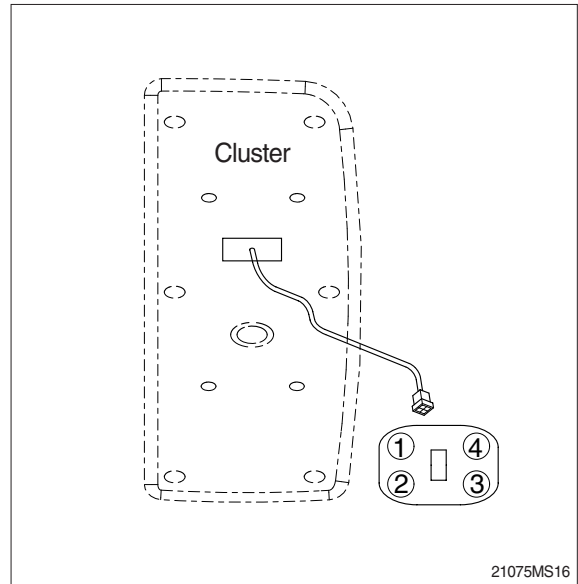

## 2) LCD main operation display

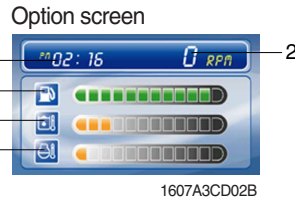
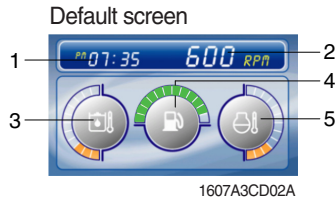

- 1 Time display
- 2 RPM display
- 3 Hydraulic oil temperature gauge
- 4 Fuel level gauge
- 5 Engine coolant temperature gauge

### (1) Time display



- ① This displays the current time.

※ Refer to the page 5-26 to set time for details.

### (2) RPM display



- ① This displays the engine rpm.

### (3) Hydraulic oil temperature gauge

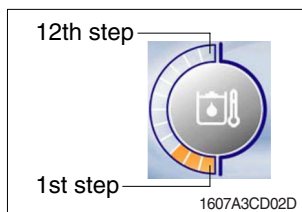

- ① This gauge indicates the temperature of hydraulic oil in 12 step gauge.

- 1st step : Below 30°C(86°F)
- 2nd~10th step : 30-105 °C(86-221°F)
- 11th~12th step : Above 105°C(221°F)

- ② The gauge between 2nd and 10th steps illuminates when operating.

- ③ Keep idling engine at low speed until the gauge between 2nd and 10th steps illuminates, before operation of machine.

- ④ When the gauge of 11th and 12th steps illuminates, reduce the load on the system. If the gauge stays in the 11th~12th steps, stop the machine and check the cause of the problem.

### (4) Fuel level gauge

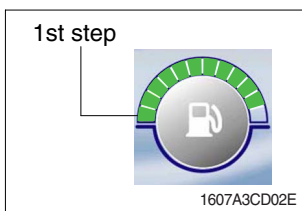

- ① This gauge indicates the amount of fuel in the fuel tank.

- ② Fill the fuel when the 1st step or fuel icon blinks in red.

※ If the gauge illuminates the 1st step or fuel icon blinks in red even though the machine is on the normal condition, check the electric device as that can be caused by the poor connection of electricity or sensor.

### (5) Engine coolant temperature gauge

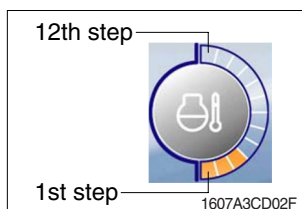

- ① This gauge indicates the temperature of coolant in 12 step gauge.

- 1st step : Below 30°C(86°F)
- 2nd~10th step : 30-105 °C(86-221°F)
- 11th~12th step : Above 105°C(221°F)

- ② The gauge between 2nd and 10th steps illuminates when operating.

- ③ Keep idling engine at low speed until the gauge between 2nd and 10th steps illuminates, before operation of machine.

- ④ When the gauge of 11th and 12th steps illuminates, turn OFF the engine, check the radiator and engine.

### 3) Warning of main operation screen

#### (1) Warning display

##### ① Engine coolant temperature



- This lamp blinks and the buzzer sounds when the temperature of coolant is over the normal temperature 105°C ( 221°F ) .
- Check the cooling system when the lamp blinks.

##### ② Fuel level



- This lamp blinks and the buzzer sounds when the level of fuel is below 28 l (7.4U.S. gal).
- Fill the fuel immediately when the lamp blinks.

##### ③ Hydraulic oil temperature



- This warning lamp operates and the buzzer sounds when the temperature of hydraulic oil is over 105 °C ( 221 °F ) .
- Check the hydraulic oil level when the lamp blinks.
- Check for debris between oil cooler and radiator.

##### ④ All gauge



- This lamp blinks and the buzzer sounds when the all gauge is abnormal.
- Check the each system when the lamp blinks.

##### ⑤ Communication error



- Communication problem between MCU controller and cluster makes the lamp blinks and the buzzer sounds.
- Check if any fuse for MCU burnt off.  
If not check the communication line between them.

#### (2) Pop-up icon display





No	Switch	Selected mode	Display
1	Power mode switch	High power work mode	
		Standard power work mode	
		Light power work mode	

No	Switch	Selected mode	Display
2	Travel speed control switch	Low speed	
		High speed	

#### 4) LCD







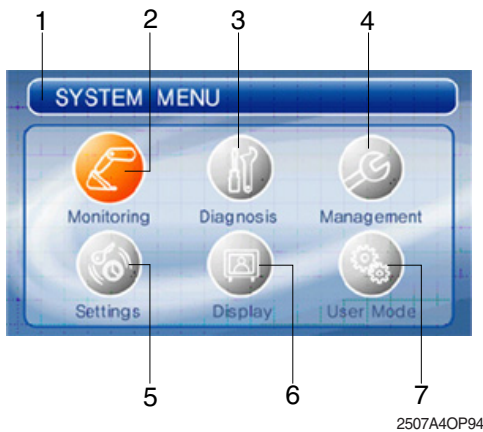

1107A3CD03

- 1  : LCD
- 2  : Escape,  
Return to the previous menu
- 3  : Down/Left Direction
- 4  : Up/Right Direction
- 5  : Select(Enter)  
Activate the currently chosen item

#### (1) Main menu



2507A40P94

- 1  : Menu information
- 2  : Monitoring  
- Equipment, Switch, Output
- 3  : Diagnosis  
- Current error, Recorded error
- 4  : Maintenance
- 5  : Settings  
- Time set, Dual mode  
- System lock(Reserved)
- 6  : Display  
- Operation skin, Brightness, Language
- 7  : User mode(null)

## (2) Display map

### ① Monitoring

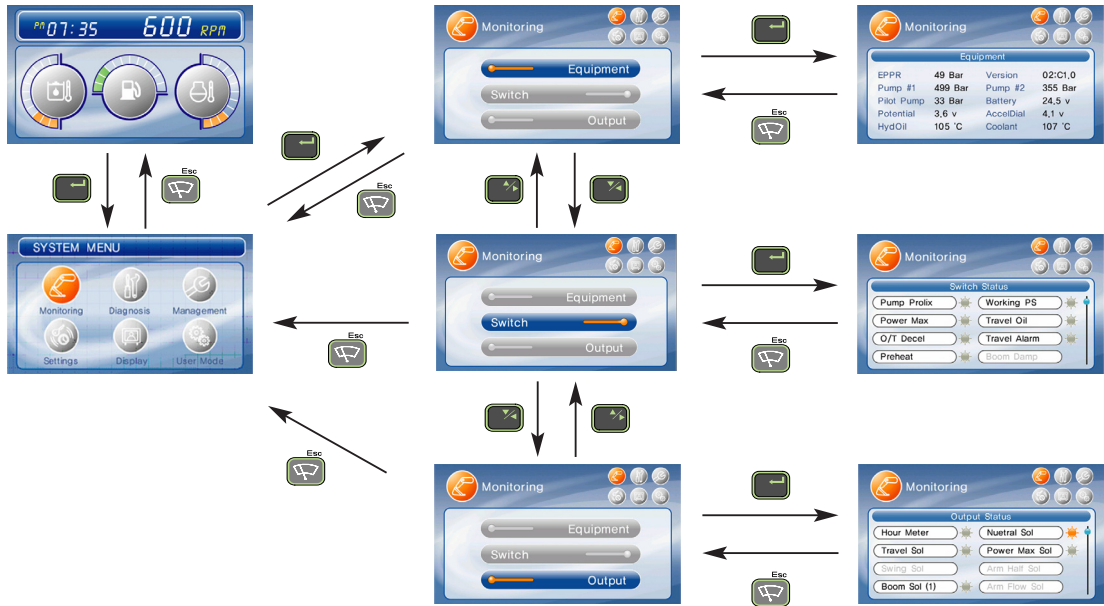

### ② Diagnosis

#### a. Protocol type 1

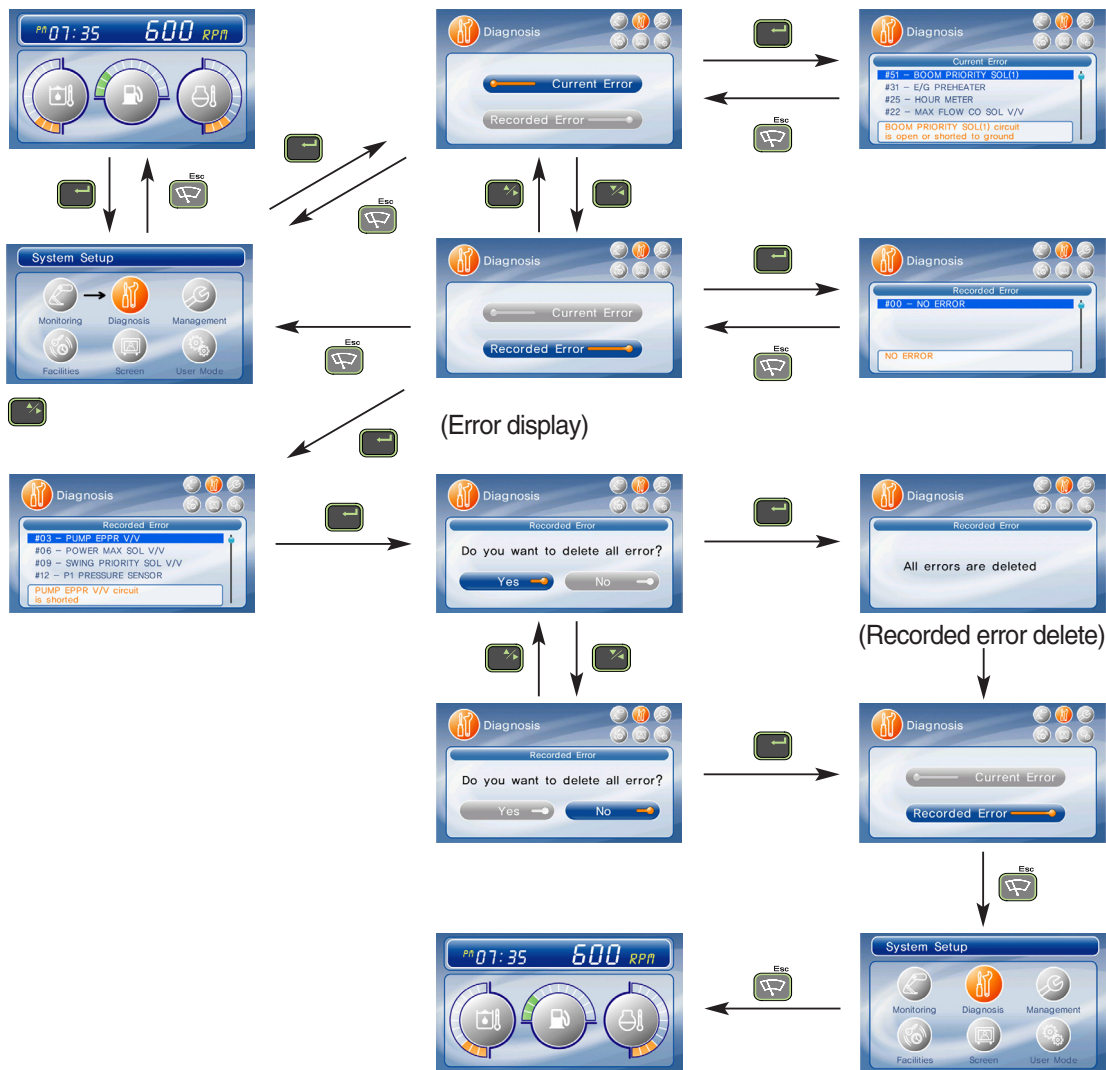



b. Protocol type 2

- If there are more than 2 error codes, each one can be displayed by pressing or switch respectively.
- 3 error codes (①SPN200200, ②FMI06, ③SPN6789, ④FMI04, ⑤345) display.

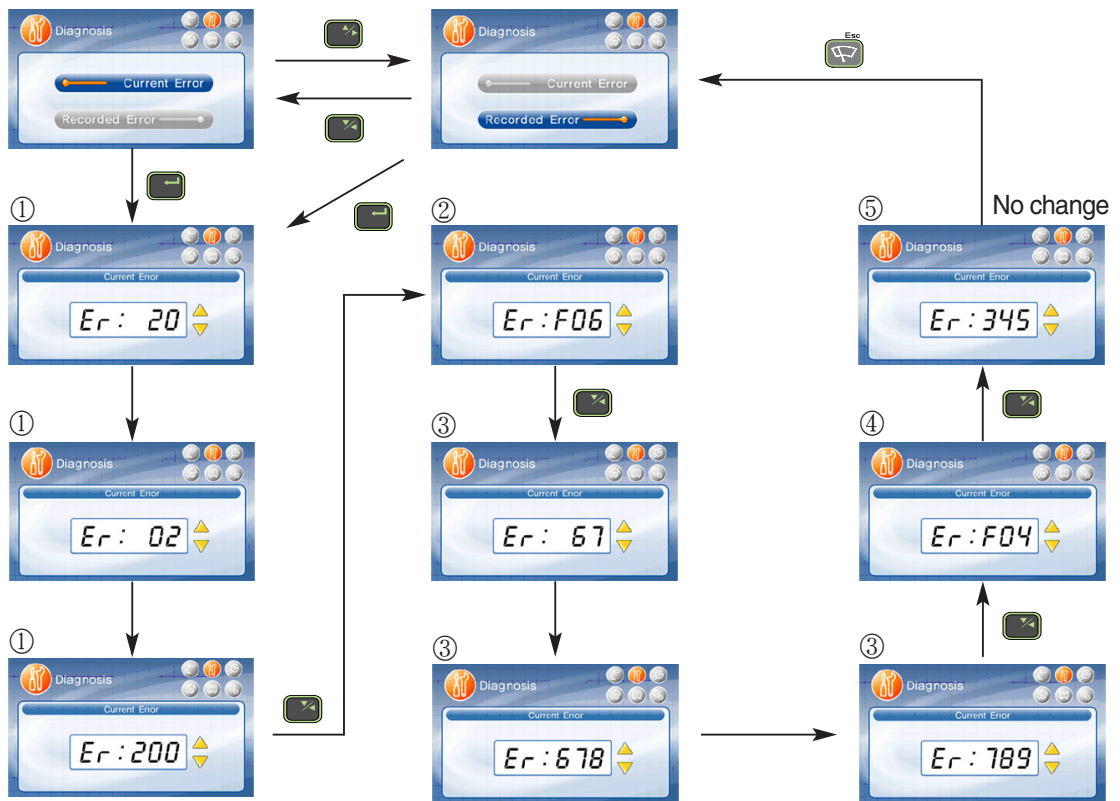

③ Maintenance

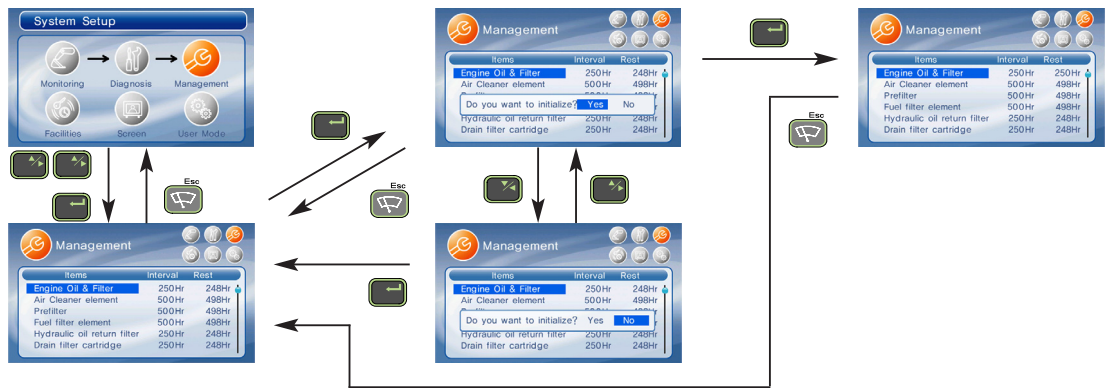

④ Setting

a. Time set

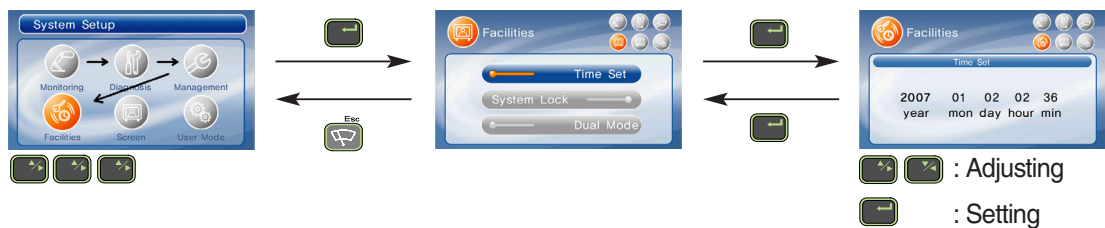

b. System lock - Reserved

c. Dual mode  
- Changing the MCU mode



⑤ Display

a. Operation skin

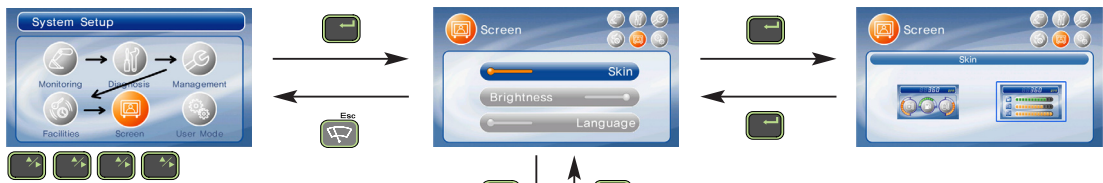

b. Brightness

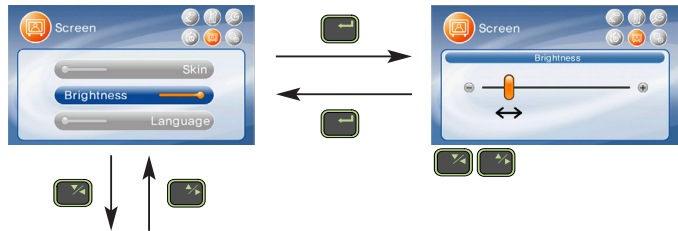

c. Language

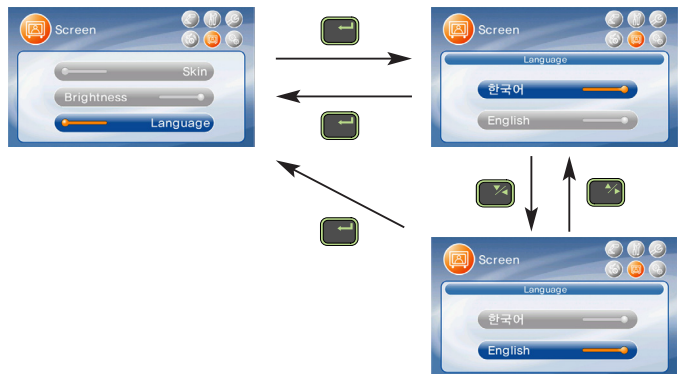



## 5) Warning and pilot lamp

### (1) Engine oil pressure warning lamp

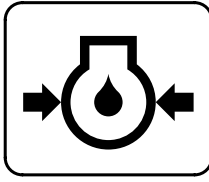

21073CD07

- ① This lamp blinks and the buzzer sounds after starting the engine because of the low oil pressure.
- ② If the lamp blinks during engine operation, shut OFF engine immediately. Check oil level.

### (2) Air cleaner warning lamp

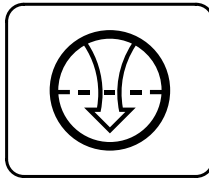

21073CD08

- ① This lamp blinks and the buzzer sounds when the filter of air cleaner is clogged.
- ② Check the filter and clean or replace it.

### (3) MCU controller check warning lamp

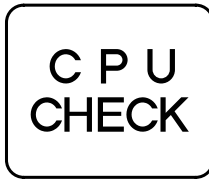

21073CD10

- ① If any fault code is received from MCU controller, this lamp blinks and the buzzer sounds.
- ② Check the communication line between MCU controller and cluster.

### (4) Battery charging warning lamp

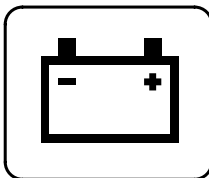

21073CD13

- ① This lamp blinks and the buzzer sounds when the starting switch is ON, it is turned OFF after starting the engine.
- ② Check the battery charging circuit when this lamp blinks during engine operation.

### (5) Overload warning lamp

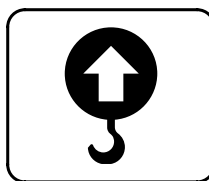

21073CD15

- ① When the machine is overload, the overload warning lamp blinks during the overload switch is ON.

#### (6) Engine check warning lamp

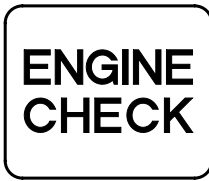

29073CD10

- ① This lamp blinks and the buzzer sounds when the communication between MCU controller and ECU on the engine is abnormal, or if any fault code received from ECU.
- ② Check the communication line between them.  
If the communication line is OK, then check the fault code on the cluster

#### (7) Power max pilot lamp



21073CD11

- ① The lamp will be ON when pushing power max switch on the LH RCV lever.

#### (8) Decel pilot lamp

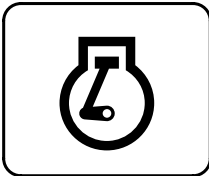

21073CD17

- ① Operating auto decel or one touch decel makes the lamp ON.
- ② The lamp will be ON when pushing one touch decel switch on the LH RCV lever.

#### (9) Warming up pilot lamp

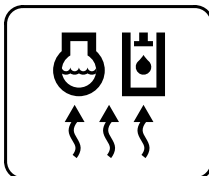

21073CD18

- ① This lamp is turned ON when the coolant temperature is below 30°C (86 °F).
- ② The automatic warming up is cancelled when the engine coolant temperature is above 30 °C, or when 10 minutes have passed since starting.

#### (10) Preheat pilot lamp

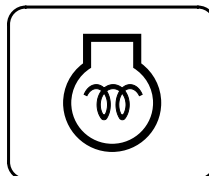

21073CD12

- ① Turning the start key switch ON position starts preheating in cold weather.
- ② Start the engine as this lamp is OFF.

# GROUP 12 FUEL WARMER SYSTEM

## 1. SPECIFICATION

- 1) Operating voltage :  $24 \pm 4V$
- 2) Power :  $350 \pm 50W$
- 3) Current : 15A

## 2. OPERATION

- 1) The current of fuel warmer system is automatically controlled without thermostat according to fuel temperature.
  - 2) At the first state, the 15A current flows to the fuel warmer and engine may be started in 1~2 minutes.
  - 3) If the fuel starts to flow, ceramic-disk in the fuel warmer heater senses the fuel temperature to reduce the current as low as 1.5A.
- So, fuel is protected from overheating by this mechanism.

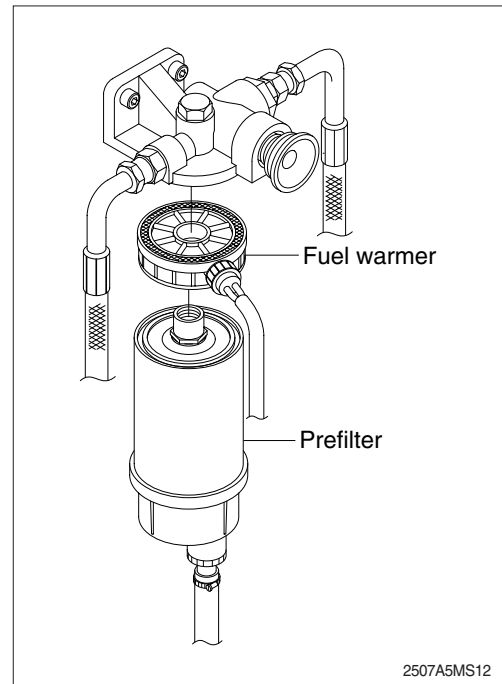

## 3. ELECTRIC CIRCUIT

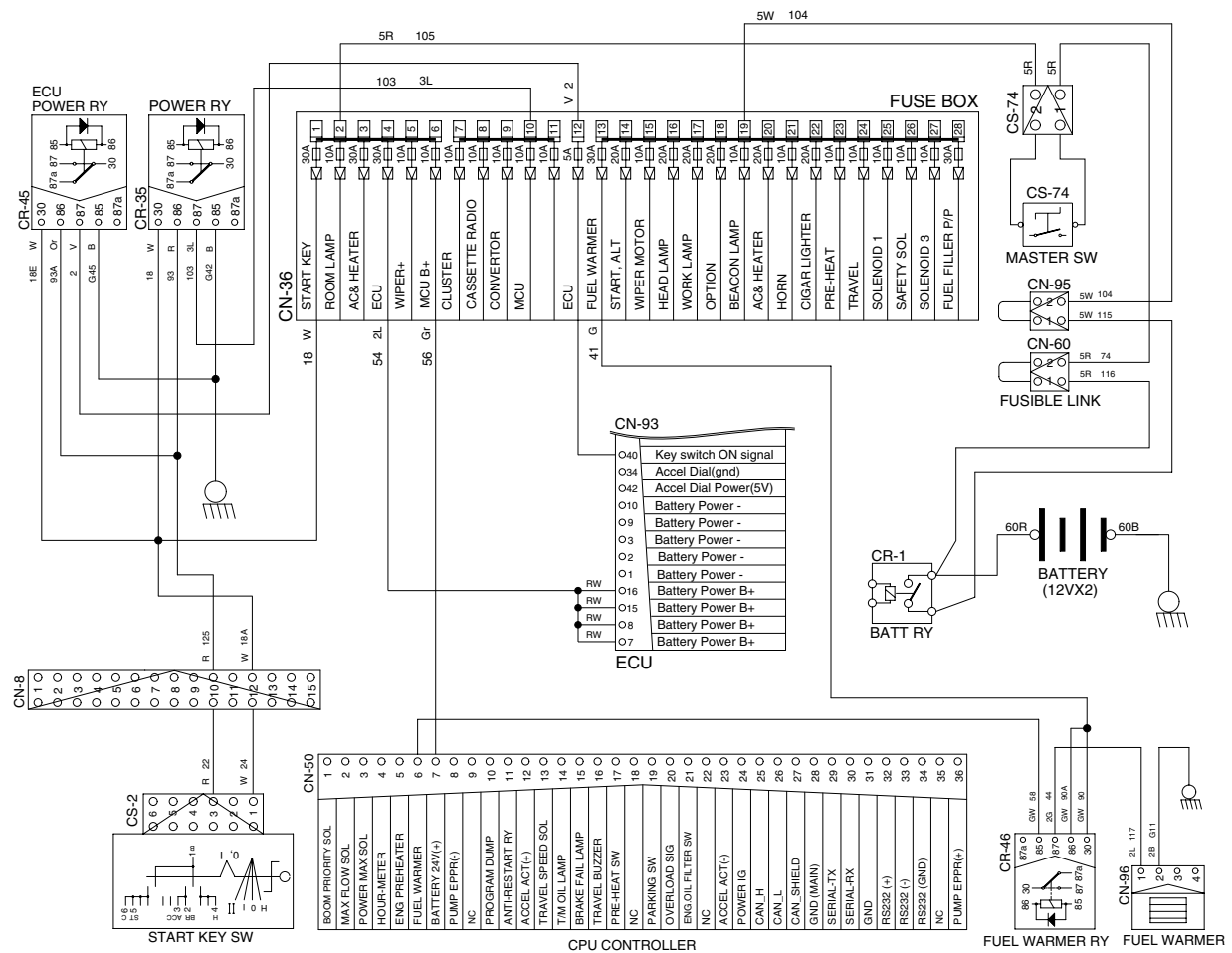

1107A5MS14