

SECTION 1 GENERAL



Group 1 Safety Hints	1-1
Group 2 Specifications	1-9

SECTION 1 GENERAL

GROUP 1 SAFETY

FOLLOW SAFE PROCEDURE

Unsafe work practices are dangerous. Understand service procedure before doing work; Do not attempt shortcuts.

WEAR PROTECTIVE CLOTHING

Wear close fitting clothing and safety equipment appropriate to the job.

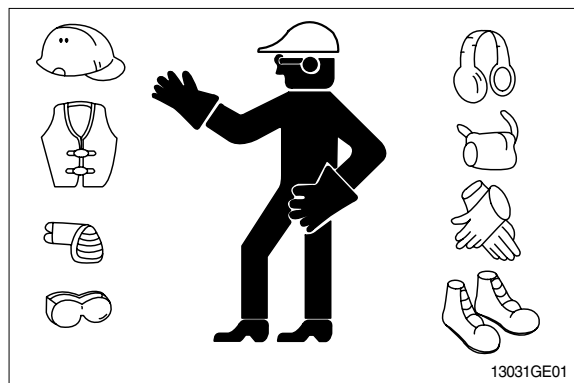

WARN OTHERS OF SERVICE WORK

Unexpected machine movement can cause serious injury.

Before performing any work on the excavator, attach a 「Do Not Operate」 tag on the right side control lever.

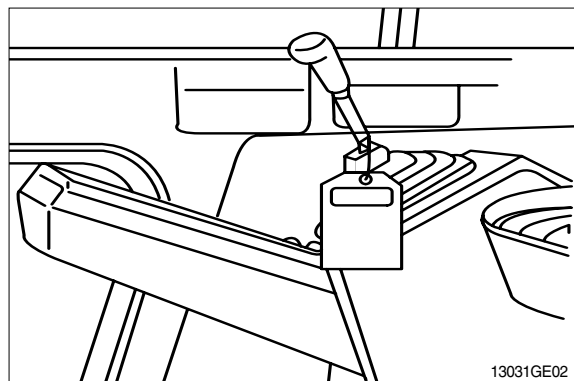

USE HANDHOLDS AND STEPS

Falling is one of the major causes of personal injury. When you get on and off the machine, always maintain a three point contact with the steps and handrails and face the machine. Do not use any controls as handholds.

Never jump on or off the machine. Never mount or dismount a moving machine.

Be careful of slippery conditions on platforms, steps, and handrails when leaving the machine.

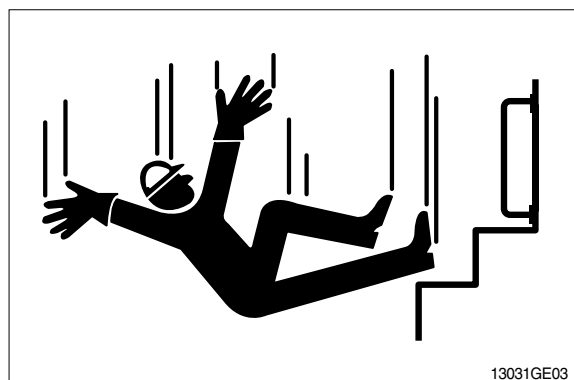

PREPARE FOR EMERGENCIES

Be prepared if a fire starts.

Keep a first aid kit and fire extinguisher handy.

Keep emergency numbers for doctors, ambulance service, hospital, and fire department near your telephone.

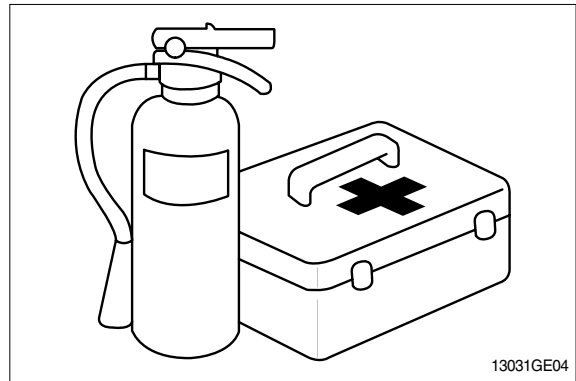

PROTECT AGAINST FLYING DEBRIS

Guard against injury from flying pieces of metal or debris; Wear goggles or safety glasses.

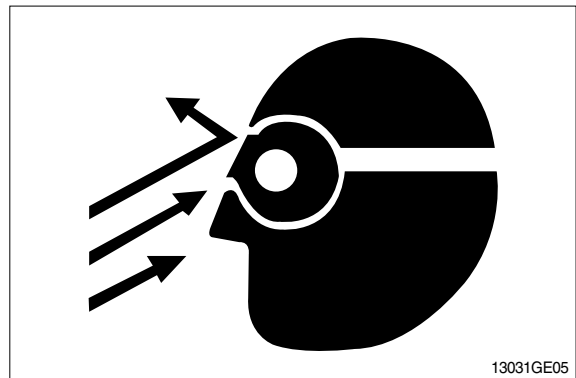

PROTECT AGAINST NOISE

Prolonged exposure to loud noise can cause impairment or loss of hearing.

Wear a suitable hearing protective device such as earmuffs or earplugs to protect against objectionable or uncomfortable loud noises.

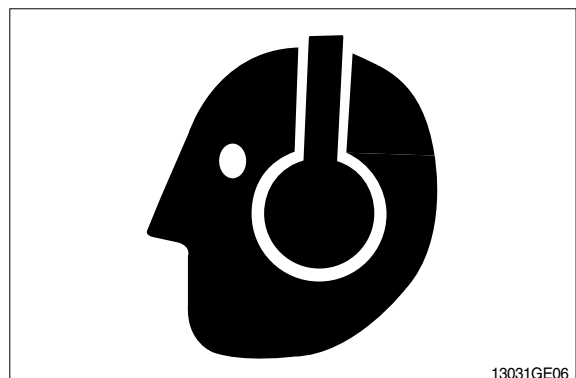

AVOID POWER LINES

Serious injury or death can result from contact with electric lines.

Never move any part of the machine or load closer to electric line than 3m(10ft) plus twice the line insulator length.

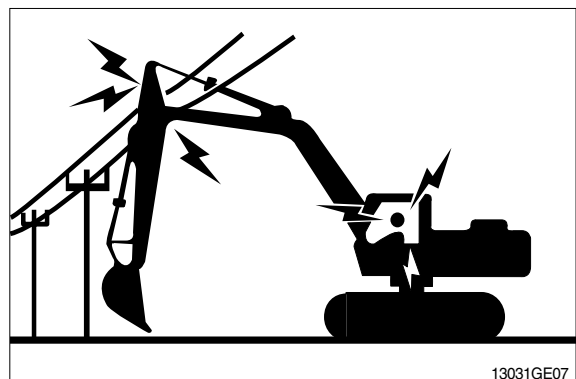

KEEP RIDERS OFF EXCAVATOR

Only allow the operator on the excavator. Keep riders off.

Riders on excavator are subject to injury such as being struck by foreign objects and being thrown off the excavator. Riders also obstruct the operator's view resulting in the excavator being operated in an unsafe manner.

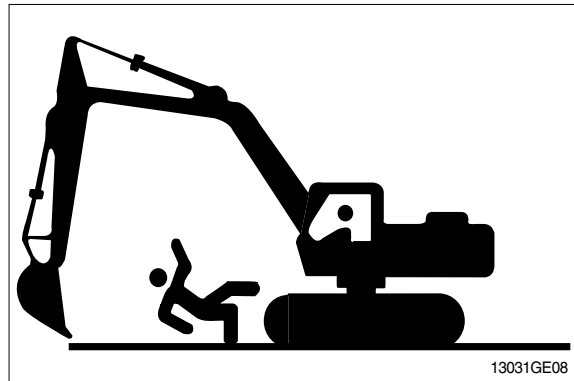

MOVE AND OPERATE MACHINE SAFELY

Bystanders can be run over. Know the location of bystanders before moving, swinging, or operating the machine.

Always keep the travel alarm in working condition. It warns people when the excavator starts to move.

Use a signal person when moving, swinging, or operating the machine in congested areas. Coordinate hand signals before starting the excavator.

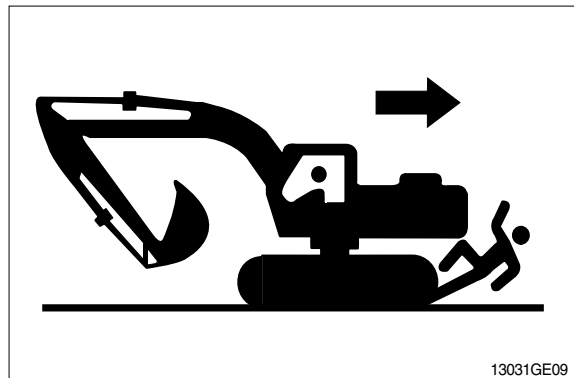

OPERATE ONLY FROM OPERATOR'S SEAT

Avoid possible injury machine damage. Do not start engine by shorting across starter terminals.

NEVER start engine while standing on ground. Start engine only from operator's seat.



PARK MACHINE SAFELY

Before working on the machine:

- Park machine on a level surface.
- Lower bucket to the ground.
- Turn auto idle switch off.
- Run engine at 1/2 speed without load for 2 minutes.
- Turn key switch to OFF to stop engine.
Remove key from switch.
- Move pilot control shutoff lever to locked position.
- Allow engine to cool.

SUPPORT MACHINE PROPERLY

Always lower the attachment or implement to the ground before you work on the machine. If you must work on a lifted machine or attachment, securely support the machine or attachment.

Do not support the machine on cinder blocks, hollow tiles, or props that may crumble under continuous load. Do not work under a machine that is supported solely by a jack. Follow recommended procedures in this manual.

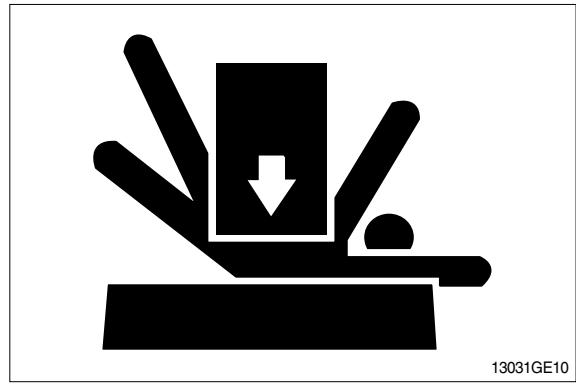

SERVICE COOLING SYSTEM SAFELY

Explosive release of fluids from pressurized cooling system can cause serious burns.

Shut off engine. Only remove filler cap when cool enough to touch with bare hands.

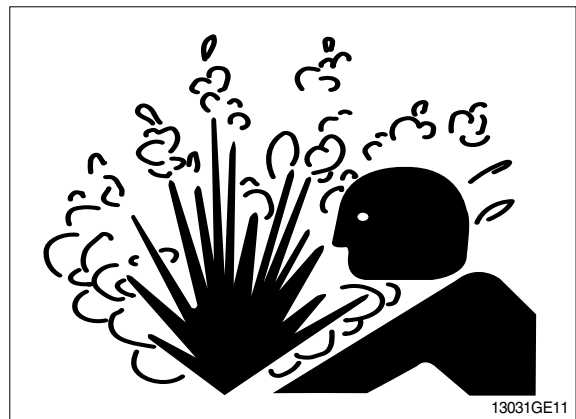

HANDLE FLUIDS SAFELY-AVOID FIRES

Handle fuel with care; It is highly flammable. Do not refuel the machine while smoking or when near open flame or sparks. Always stop engine before refueling machine.

Fill fuel tank outdoors.

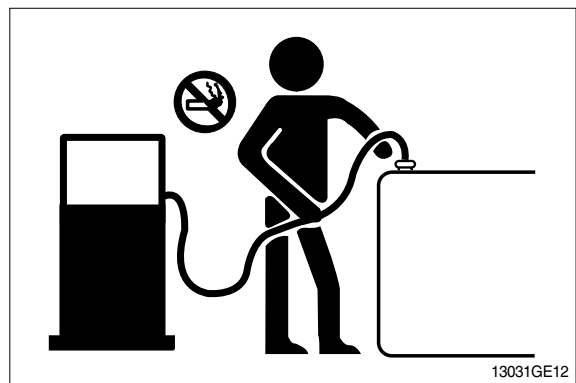

Store flammable fluids away from fire hazards. Do not incinerate or puncture pressurized containers.

Make sure machine is clean of trash, grease, and debris.

Do not store oily rags; They can ignite and burn spontaneously.

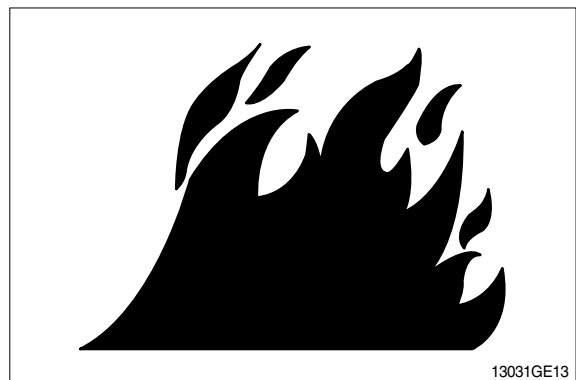

BEWARE OF EXHAUST FUMES

Prevent asphyxiation. Engine exhaust fumes can cause sickness or death.

If you must operate in a building, be positive there is adequate ventilation. Either use an exhaust pipe extension to remove the exhaust fumes or open doors and windows to bring enough outside air into the area.

REMOVE PAINT BEFORE WELDING OR HEATING

Avoid potentially toxic fumes and dust.

Hazardous fumes can be generated when paint is heated by welding, soldering, or using a torch.

Do all work outside or in a well ventilated area. Dispose of paint and solvent properly.

Remove paint before welding or heating:

- If you sand or grind paint, avoid breathing the dust. Wear an approved respirator.
- If you use solvent or paint stripper, remove stripper with soap and water before welding. Remove solvent or paint stripper containers and other flammable material from area. Allow fumes to disperse at least 15 minutes before welding or heating.

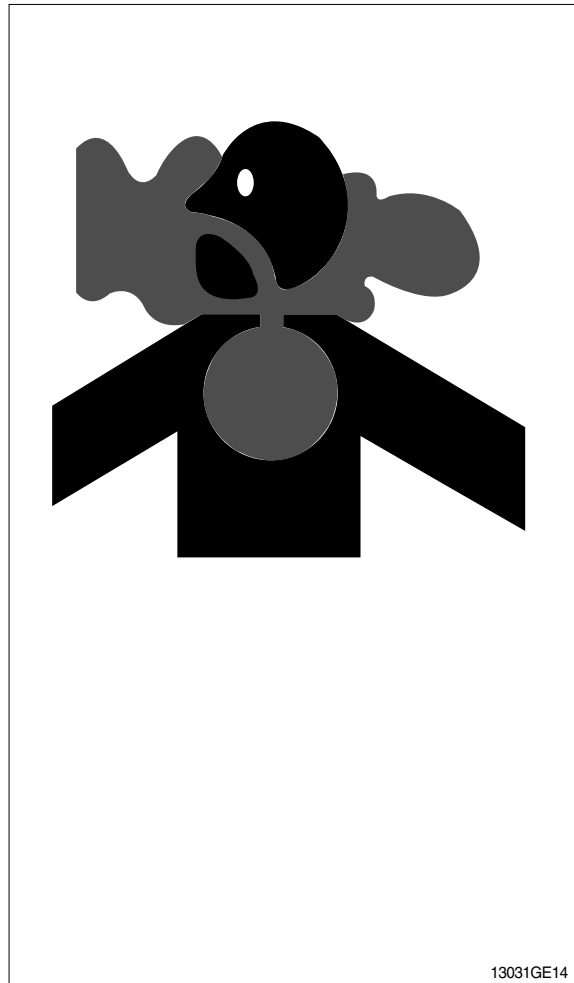

ILLUMINATE WORK AREA SAFELY

Illuminate your work area adequately but safely. Use a portable safety light for working inside or under the machine. Make sure the bulb is enclosed by a wire cage. The hot filament of an accidentally broken bulb can ignite spilled fuel or oil.



SERVICE MACHINE SAFELY

Tie long hair behind your head. Do not wear a necktie, scarf, loose clothing or necklace when you work near machine tools or moving parts. If these items were to get caught, severe injury could result.

Remove rings and other jewelry to prevent electrical shorts and entanglement in moving parts.

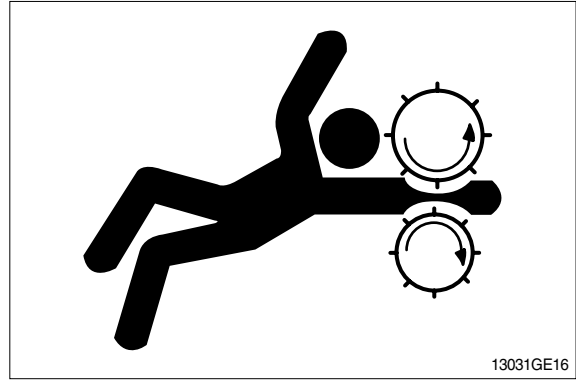

STAY CLEAR OF MOVING PARTS

Entanglements in moving parts can cause serious injury.

To prevent accidents, use care when working around rotating parts.

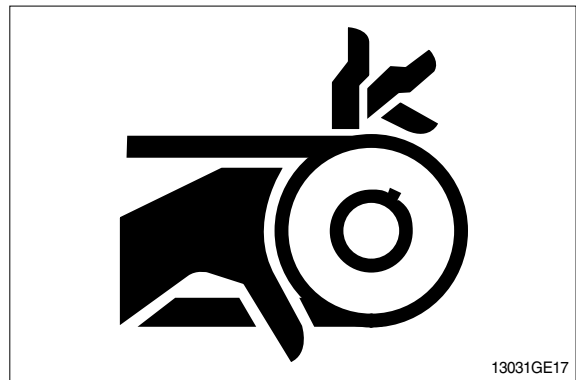

AVOID HIGH PRESSURE FLUIDS

Escaping fluid under pressure can penetrate the skin causing serious injury.

Avoid the hazard by relieving pressure before disconnecting hydraulic or other lines. Tighten all connections before applying pressure.

Search for leaks with a piece of cardboard. Protect hands and body from high pressure fluids.

If an accident occurs, see a doctor immediately. Any fluid injected into the skin must be surgically removed within a few hours or gangrene may result.

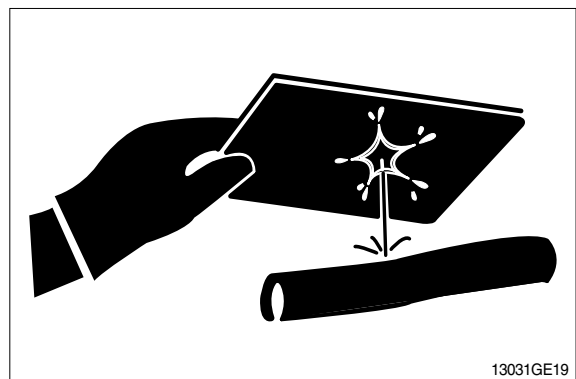

AVOID HEATING NEAR PRESSURIZED FLUID LINES

Flammable spray can be generated by heating near pressurized fluid lines, resulting in severe burns to yourself and bystanders. Do not heat by welding, soldering, or using a torch near pressurized fluid lines or other flammable materials.

Pressurized lines can be accidentally cut when heat goes beyond the immediate flame area. Install fire resisting guards to protect hoses or other materials.



PREVENT BATTERY EXPLOSIONS

Keep sparks, lighted matches, and flame away from the top of battery. Battery gas can explode.

Never check battery charge by placing a metal object across the posts. Use a volt-meter or hydrometer.

Do not charge a frozen battery; It may explode. Warm battery to 16°C (60°F).



PREVENT ACID BURNS

Sulfuric acid in battery electrolyte is poisonous. It is strong enough to burn skin, eat holes in clothing, and cause blindness if splashed into eyes.

Avoid the hazard by:

1. Filling batteries in a well-ventilated area.
2. Wearing eye protection and rubber gloves.
3. Avoiding breathing fumes when electrolyte is added.
4. Avoiding spilling or dripping electrolyte.
5. Use proper jump start procedure.

If you spill acid on yourself:

1. Flush your skin with water.
2. Apply baking soda or lime to help neutralize the acid.
3. Flush your eyes with water for 10-15 minutes. Get medical attention immediately.

If acid is swallowed:

1. Drink large amounts of water or milk.
2. Then drink milk of magnesia, beaten eggs, or vegetable oil.
3. Get medical attention immediately.

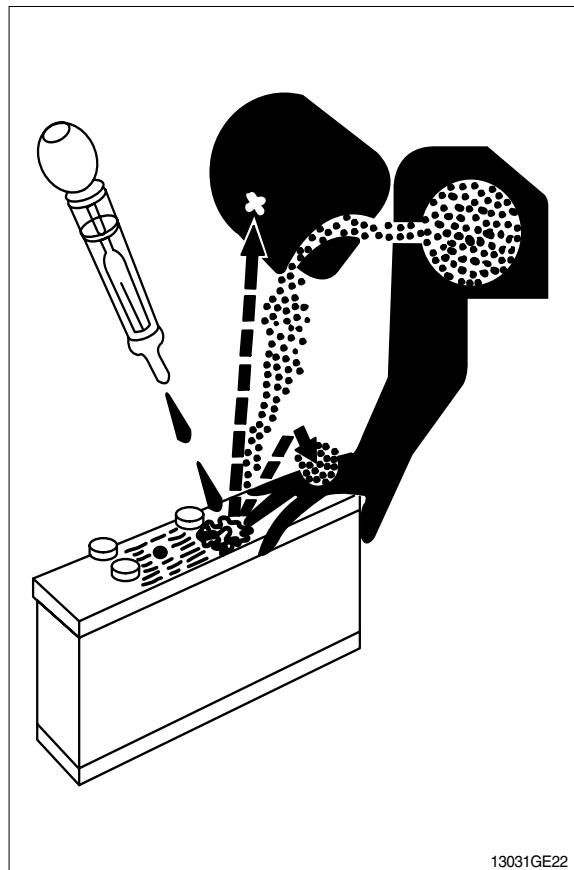

USE TOOLS PROPERLY

Use tools appropriate to the work. Makeshift tools, parts, and procedures can create safety hazards.

Use power tools only to loosen threaded tools and fasteners.

For loosening and tightening hardware, use the correct size tools. DO NOT use U.S. measurement tools on metric fasteners. Avoid bodily injury caused by slipping wrenches.

Use only recommended replacement parts.(See Parts catalogue.)

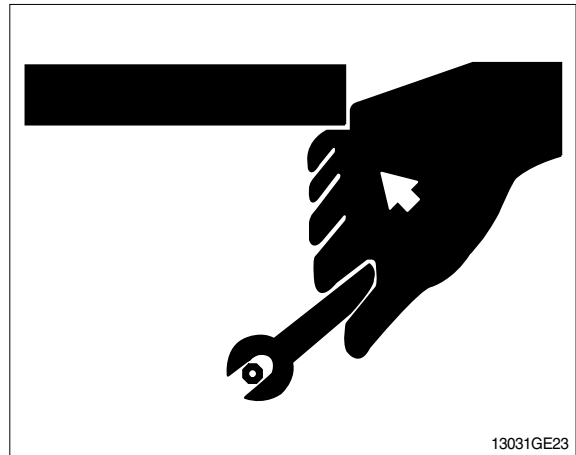

DISPOSE OF FLUIDS PROPERLY

Improperly disposing of fluids can harm the environment and ecology. Before draining any fluids, find out the proper way to dispose of waste from your local environmental agency.

Use proper containers when draining fluids. Do not use food or beverage containers that may mislead someone into drinking from them.

DO NOT pour oil into the ground, down a drain, or into a stream, pond, or lake. Observe relevant environmental protection regulations when disposing of oil, fuel, coolant, brake fluid, filters, batteries, and other harmful waste.

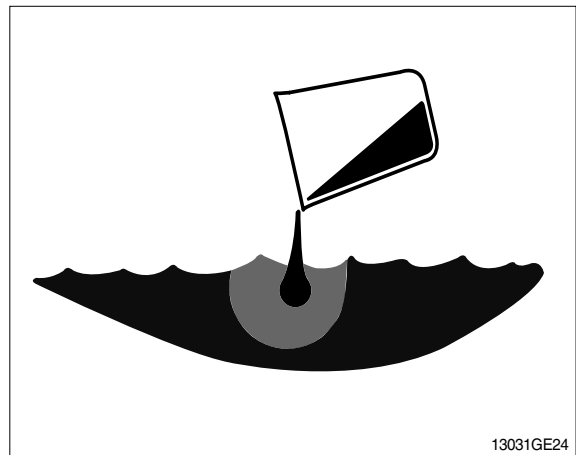

REPLACE SAFETY SIGNS

Replace missing or damaged safety signs. See the machine operator's manual for correct safety sign placement.

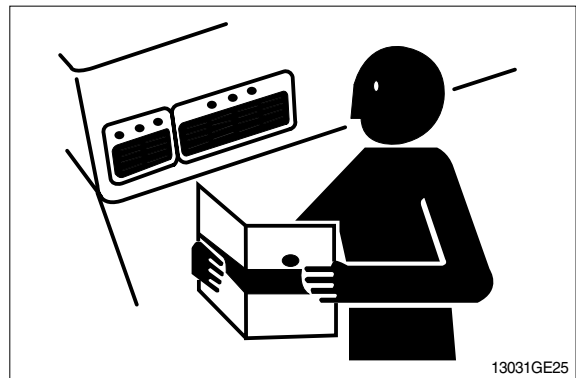

LIVE WITH SAFETY

Before returning machine to customer, make sure machine is functioning properly, especially the safety systems. Install all guards and shields.

GROUP 2 SPECIFICATIONS

1. MAJOR COMPONENT

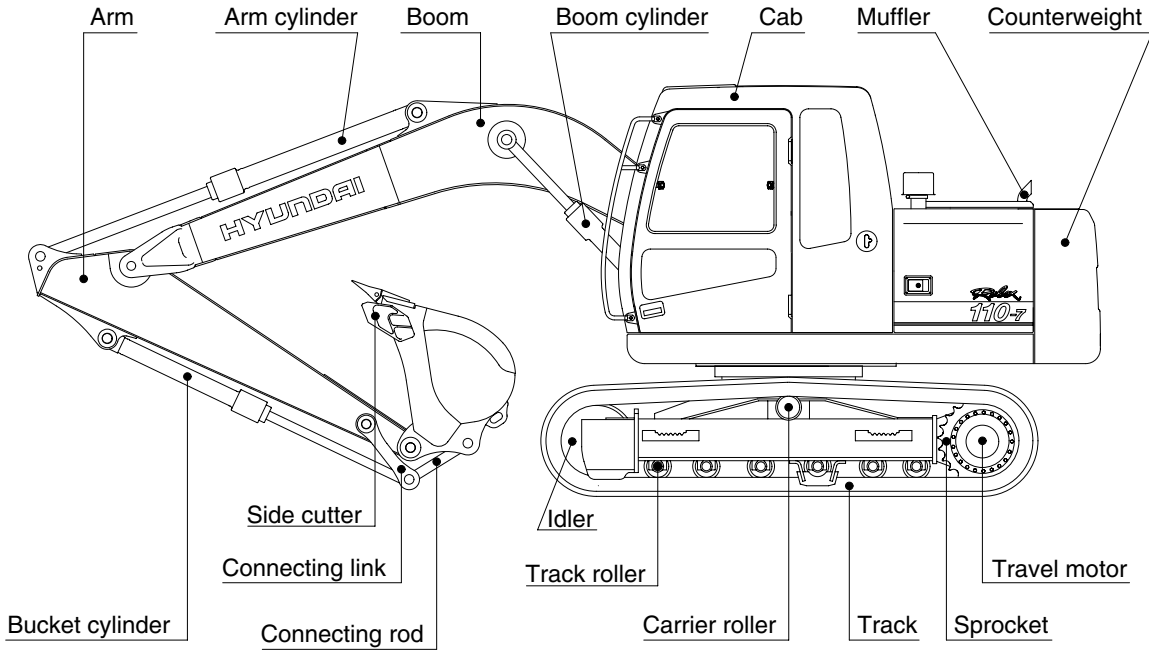
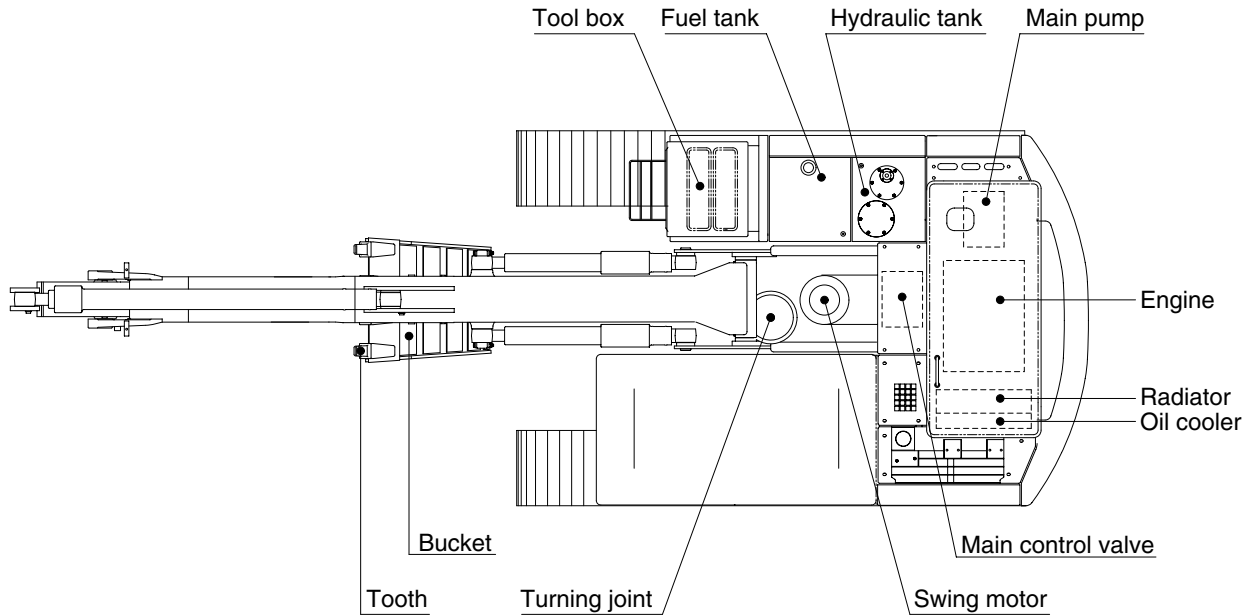

11072SP01

2. SPECIFICATIONS

1) R110-7

(1) 4.3m(14' 1") MONO BOOM, 2.26m(7' 5") ARM

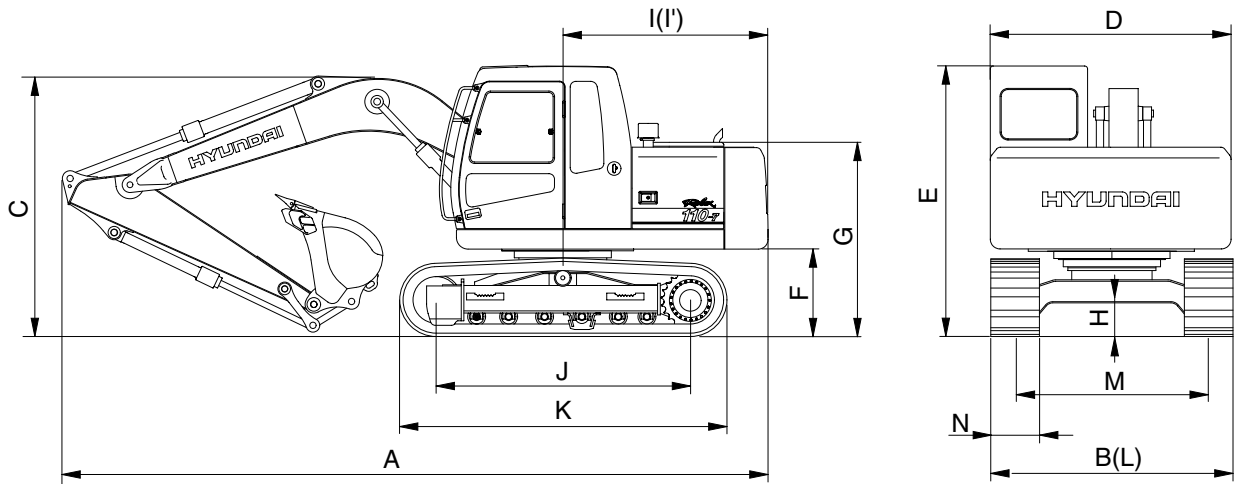

11072SP02

Description		Unit	Specification
Operating weight		kg(lb)	11200(24690)
Bucket capacity(SAE heaped), standard		m ³ (yd ³)	0.45(0.59)
Overall length	A	mm(ft-in)	7270(23' 10")
Overall width, with 500mm shoe	B		2490(8' 2")
Overall height	C		2720(8' 11")
Superstructure width	D		2475(8' 1")
Overall height of cab	E		2800(9' 2")
Ground clearance of counterweight	F		900(2' 11")
Engine cover height	G		1990(6' 6")
Minimum ground clearance	H		440(1' 5")
Rear-end distance	I		2110(6' 11")
Rear-end swing radius	I'		2130(7' 0")
Distance between tumblers	J		2610(8' 7")
Undercarriage length	K		3340(10' 11")
Undercarriage width	L		2490(8' 2")
Track gauge	M		1990(6' 6")
Track shoe width, standard	N		500(20")
Travel speed(Low/high)			km/hr(mph)
Swing speed		rpm	13.0
Gradeability		Degree(%)	35(70)
Ground pressure(500mm shoe)		kgf/cm ² (psi)	0.39(5.55)

2) R110D-7

(1) 4.3m(14' 1") MONO BOOM, 2.26m(7' 5") ARM AND REAR DOZER BLADE

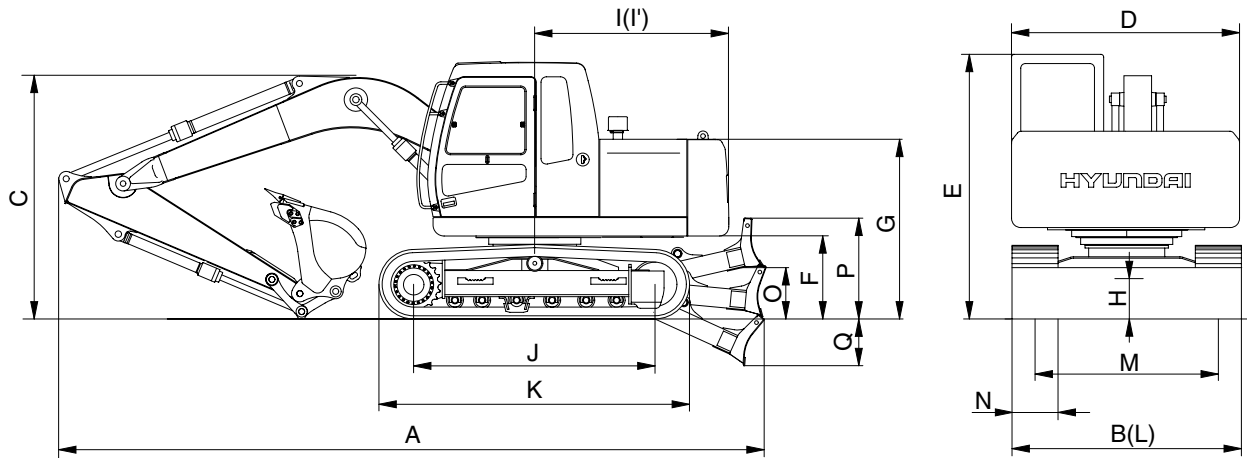

11072SP02A

Description		Unit	Specification	
Operating weight		kg(lb)	11900(26230)	
Bucket capacity(SAE heaped), standard		m ³ (yd ³)	0.45(0.59)	
Overall length	A	mm(ft-in)	7650(25' 1")	
Overall width, with 500mm shoe	B		2500(8' 2")	
Overall height	C		2720(8' 11")	
Superstructure width	D		2475(8' 1")	
Overall height of cab	E		2800(9' 2")	
Ground clearance of counterweight	F		900(2' 11")	
Engine cover height	G		1990(6' 6")	
Minimum ground clearance	H		440(1' 5")	
Rear-end distance	I		2110(6' 11")	
Rear-end swing radius	I'		2130(7' 0")	
Distance between tumblers	J		2610(8' 7")	
Undercarriage length	K		3340(10' 11")	
Undercarriage width	L		2500(8' 2")	
Track gauge	M		1990(6' 6")	
Track shoe width, standard	N		500(20")	
Height of blade	O		550(1' 10")	
Ground clearance of blade up	P		500(1' 8")	
Depth of blade down	Q		520(1' 8")	
Travel speed(Low/high)			km/hr(mph)	3.4/5.5(2.1/3.4)
Swing speed			rpm	13.0
Gradeability		Degree(%)	35(70)	
Ground pressure(500mm shoe)		kgf/cm ² (psi)	0.42(5.97)	

3. WORKING RANGE

1) R110-7

(1) 4.3m(14' 1") MONO BOOM

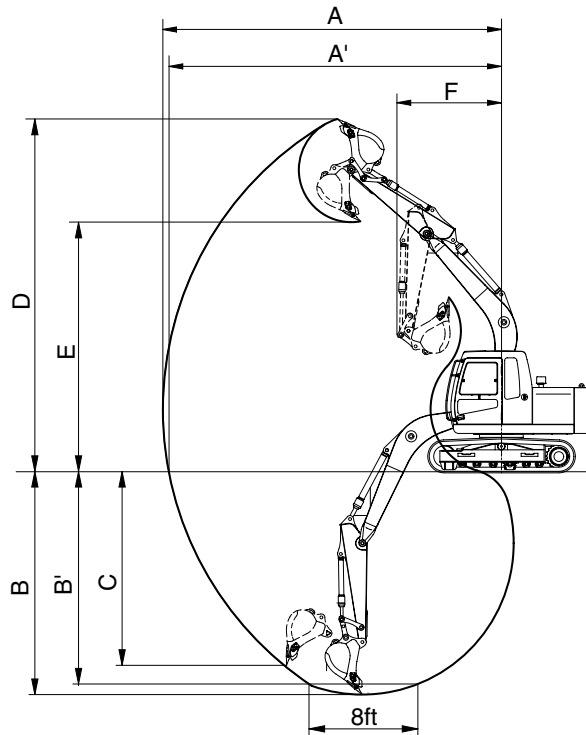

11072SP03

Description		1.96m(6' 5") Arm	2.26m(7' 5") Arm	2.81m(9' 3") Arm
Max digging reach	A	7460mm (24' 6")	7740mm (25' 5")	8270mm (27' 2")
Max digging reach on ground	A'	7320mm (24' 0")	7610mm (25' 0")	8140mm (26' 8")
Max digging depth	B	4770mm (15' 8")	5090mm (16' 8")	5620mm (18' 5")
Max digging depth (8ft level)	B'	4510mm (14'10")	4870mm (16' 0")	5410mm (17' 9")
Max vertical wall digging depth	C	4070mm (13' 4")	4430mm (14' 6")	4940mm (16' 2")
Max digging height	D	7900mm (25'11")	8070mm (26' 6")	8460mm (27' 9")
Max dumping height	E	5540mm (18' 2")	5710mm (18' 9")	6100mm (20' 0")
Min swing radius	F	2340mm (7' 8")	2380mm (7'10")	2510mm (8' 3")
Bucket digging force	SAE	78.5 [85.6] kN	78.5 [85.6] kN	78.5 [85.6] kN
		8000 [8730] kgf	8000 [8730] kgf	8000 [8730] kgf
		17640 [19240] lbf	17640 [19240] lbf	17640 [19240] lbf
	ISO	90.2 [98.4] kN	90.2 [98.4] kN	90.2 [98.4] kN
		9200 [10040] kgf	9200 [10040] kgf	9200 [10040] kgf
		20280 [22120] lbf	20280 [22120] lbf	20280 [22120] lbf
Arm digging force	SAE	60.2 [65.7] kN	55.7 [60.8] kN	48.1 [52.4] kN
		6140 [6700] kgf	5680 [6200] kgf	4900 [5350] kgf
		13540 [14770] lbf	12520 [13660] lbf	10800 [11780] lbf
	ISO	62.9 [68.6] kN	58.1 [63.3] kN	49.7 [54.2] kN
		6410 [6990] kgf	5920 [6460] kgf	5070 [5530] kgf
		14130 [15410] lbf	13050 [14240] lbf	11180 [12200] lbf

[] : Power boost

2) R110D-7

(1) 4.3m(14' 1") MONO BOOM

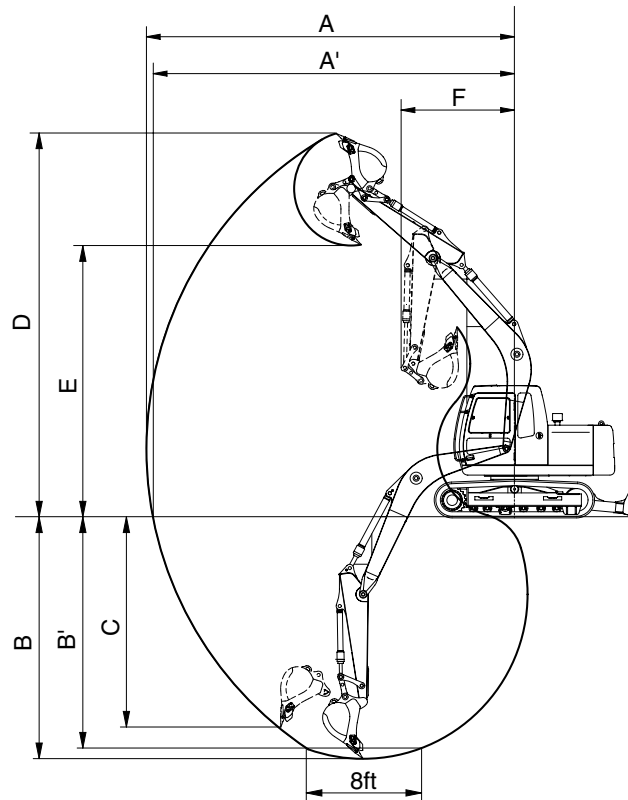

11072SP04

Description		1.96m(6' 5") Arm	2.26m(7' 5") Arm	2.81m(9' 3") Arm
Max digging reach	A	7460mm (24' 6")	7740mm (25' 5")	8270mm (27' 2")
Max digging reach on ground	A'	7320mm (24' 0")	7610mm (25' 0")	8140mm (26' 8")
Max digging depth	B	4770mm (15' 8")	5090mm (16' 8")	5620mm (18' 5")
Max digging depth (8ft level)	B'	4510mm (14'10")	4870mm (16' 0")	5410mm (17' 9")
Max vertical wall digging depth	C	4070mm (13' 4")	4430mm (14' 6")	4940mm (16' 2")
Max digging height	D	7900mm (25'11")	8070mm (26' 6")	8460mm (27' 9")
Max dumping height	E	5540mm (18' 2")	5710mm (18' 9")	6100mm (20' 0")
Min swing radius	F	2340mm (7' 8")	2380mm (7'10")	2510mm (8' 3")
Bucket digging force	SAE	78.5 [85.6] kN	78.5 [85.6] kN	78.5 [85.6] kN
		8000 [8730] kgf	8000 [8730] kgf	8000 [8730] kgf
		17640 [19240] lbf	17640 [9240] lbf	17640 [19240] lbf
	ISO	90.2 [98.4] kN	90.2 [98.4] kN	90.2 [98.4] kN
		9200 [10040] kgf	9200 [10040] kgf	9200 [10040] kgf
		20280 [22120] lbf	20280 [22120] lbf	20280 [22120] lbf
Arm digging force	SAE	60.2 [65.7] kN	55.7 [60.8] kN	48.1 [52.4] kN
		6140 [6700] kgf	5680 [6200] kgf	4900 [5350] kgf
		13540 [14770] lbf	12520 [13660] lbf	10800 [11780] lbf
	ISO	62.9 [68.6] kN	58.1 [63.3] kN	49.7 [54.2] kN
		6410 [6990] kgf	5920 [6460] kgf	5070 [5530] kgf
		14130 [15410] lbf	13050 [14240] lbf	11180 [12200] lbf

[] : Power boost

4. WEIGHT

Item	kg	lb
Upperstructure assembly	3300	7280
Main frame weld assembly	1030	2270
Engine assembly	550	1210
Main pump assembly	90	200
Main control valve assembly	130	260
Swing motor assembly	80	180
Hydraulic oil tank assembly	180	400
Fuel tank assembly	130	290
Counterweight	1450	3200
Cab assembly	310	680
Lower chassis assembly	3990	8800
Track frame weld assembly	1260	2780
Swing bearing	160	250
Travel motor assembly	330	730
Turning joint	60	130
Track recoil spring	210	460
Idler	390	860
Carrier roller	30	66
Track roller	300	660
Track-chain assembly(500mm standard triple grouser shoe)	1350	2980
Front attachment assembly(4.3m boom, 2.26m arm, 0.45m ³ SAE heaped bucket)	1640	3620
4.3m boom assembly	740	1630
2.26m arm assembly	340	750
0.45m ³ SAE heaped bucket	440	970
Boom cylinder assembly	230	510
Arm cylinder assembly	140	310
Dozer blade cylinder	47	100
Bucket cylinder assembly	90	200
Bucket control link assembly	80	180
Dozer blade assembly	700	1540











5. LIFTING CAPACITIES

1) ROBEX 110-7











(1) 4.3m(14' 1") boom, 2.26m(7' 5") arm equipped with 0.45m³(SAE heaped) bucket and 500mm(20") triple grouser shoe.

•  : Rating over-front

•  : Rating over-side or 360 degree











Load point height		Load radius								At max. reach		
		1.5m(5ft)		3.0m(10ft)		4.5m(15ft)		6.0m(20ft)		Capacity		Reach
												m(ft)
6.0m (20ft)	kg lb					*1750 *3860	*1750 *3860			*1750 *3860	*1560 *3440	5.99 (19.7)
4.5m (15ft)	kg lb					*1790 *3950	*1790 *3950	*1530 *3370	1490 3280	1520 3350	1130 2490	6.92 (22.7)
3.0m (10ft)	kg lb			*2820 *6220	*2820 *6220	*2270 *5000	*2270 *5000	1940 4280	1450 3200	1300 2870	940 2070	7.38 (24.2)
1.5m (5ft)	kg lb			*4700 *10360	4370 9630	*2970 *6550	2250 4960	1840 4060	1360 3000	1240 2730	880 1940	7.46 (24.5)
Ground Line	kg lb			5660 12480	3950 8710	2830 6240	2060 4540	1760 3880	1280 2820	1300 2870	930 2050	7.18 (23.6)
-1.5m (-5ft)	kg lb	*5580 *12300	*5580 *12300	5550 12240	3850 8490	2740 6040	1980 4370	1720 3790	1240 2730	1560 3440	1130 2490	6.49 (21.3)
-3.0m (-10ft)	kg lb	*8530 *18810	*8530 *18810	*5440 *11990	3930 8660	2770 6110	2010 4430			*2270 *5000	1730 3810	5.17 (17.0)

(2) 4.3m(14' 1") boom, 1.96m(6' 5") arm equipped with 0.45m³(SAE heaped) bucket and 500mm(20") triple grouser shoe.

Load point height		Load radius								At max. reach		
		1.5m(5ft)		3.0m(10ft)		4.5m(15ft)		6.0m(20ft)		Capacity		Reach
												m(ft)
6.0m (20ft)	kg lb					*1770 *3900	*1770 *3900			*1820 *4010	1710 3770	5.62 (18.4)
4.5m (15ft)	kg lb					*1950 *4300	*1950 *4300			1610 3550	1180 2600	6.62 (21.7)
3.0m (10ft)	kg lb			*3160 *6970	*3160 *6970	*2410 *5310	2390 5270	1870 4120	1380 3040	1350 2980	970 2140	7.10 (23.3)
1.5m (5ft)	kg lb			*4940 *10890	4150 9150	2930 6460	2150 4740	1780 3920	1290 2840	1280 2820	910 2010	7.18 (23.6)
Ground Line	kg lb			5490 12100	3800 8380	2740 6040	1980 4370	1700 3750	1220 2690	1360 3000	960 2120	6.89 (22.6)
-1.5m (-5ft)	kg lb	*6090 *13430	*6090 *13430	5440 11990	3750 8270	2670 5890	1910 4210			1670 3680	1200 2650	6.15 (20.2)
-3.0m (-10ft)	kg lb	*9180 *20240	*9180 *20240	*5080 *11200	3880 8550	2750 6060	1980 4370					











- Note
1. Lifting capacity are based on SAE J1097 and ISO 10567.
 2. Lifting capacity of the ROBEX series does not exceed 75% of tipping load with the machine on firm, level ground or 87% of full hydraulic capacity.
 3. The load point is a hook located on the back of the bucket.
 4. *indicates load limited by hydraulic capacity.

(3) 4.3m(14' 1") boom, 2.81m(9' 3") arm equipped with 0.45m³(SAE heaped) bucket and 500mm(20") triple grouser shoe.











Load point height		Load radius								At max. reach		
		1.5m(5ft)		3.0m(10ft)		4.5m(15ft)		6.0m(20ft)		Capacity		Reach
												m(ft)
6.0m (20ft)	kg lb									*1570 *3460	1290 2840	6.66
4.5m (15ft)	kg lb							*1640 *3620	1570 3460	1330 2930	980 2160	7.50 (24.6)
3.0m (10ft)	kg lb					*1920 *4230	*1920 *4230	*1830 *4030	1500 3310	1160 2560	830 1830	7.92 (26.0)
1.5m	kg			*4050	*4050	*2690	2340	1890	1410	1100	780	7.99
Ground Line	kg lb	*3230 *7120	*3230 *7120	*5580 *12300	4110 9060	2900 6390	2130 4700	1790 3950	1310 2890	1150 2540	820 1810	7.74 (25.4)
-1.5m (-5ft)	kg lb	*4960 *10930	*4960 *10930	5620 12390	3920 8640	2770 6110	2010 4430	1730 3810	1250 2760	1330 2930	960 2120	7.11 (23.3)
-3.0m (-10ft)	kg lb	*7230 *15940	*7230 *15940	5630 12410	3930 8660	2760 6080	2000 4410			1830 4030	1350 2980	5.96 (19.6)
-4.5m	kg			*4480	4100							

2) ROBEX 110D-7











(1) 4.3m(14' 1") boom, 2.26m(7' 5") arm equipped with 0.45m³(SAE heaped) bucket and 500mm(20") triple grouser shoe, and rear dozer blade down.

Load point height		Load radius								At max. reach		
		1.5m(5ft)		3.0m(10ft)		4.5m(15ft)		6.0m(20ft)		Capacity		Reach
												m(ft)
6.0m (20ft)	kg lb					*1750 *3860	*1750 *3860			*1750 *3860	*1750 *3860	5.99 (19.7)
4.5m (15ft)	kg lb					*1790 *3950	*1790 *3950	*1530 *3370	*1530 *3370	1650 3640	1340 2950	6.92 (22.7)
3.0m (10ft)	kg lb			*2820 *6220	*2820 *6220	*2270 *5000	*2270 *5000	*2060 *4540	1710 3770	1420 3130	1140 2510	7.38 (24.2)
1.5m (5ft)	kg lb			*4700 *10360	*4700 *10360	*2970 *6550	2650 5840	2000 4410	1620 3570	1360 3000	1080 2380	7.46 (24.5)
Ground Line	kg lb			*5860 *12920	4750 10470	3060 6750	2460 5420	1910 4210	1540 3400	1430 3150	1140 2510	7.18 (23.6)
-1.5m (-5ft)	kg lb	*5580 *12300	*5580 *12300	5980 13180	4640 10230	2970 6550	2370 5220	1880 4140	1500 3310	1700 3750	1360 3000	6.49 (21.3)
-3.0m (-10ft)	kg lb	*8530 *18810	*8530 *18810	*5440 *11990	4720 10410	3000 6610	2400 5290			*2270 *5000	2050 4520	5.17 (17.0)

(2) 4.3m(14' 1") boom, 1.96m(6' 5") arm equipped with 0.45m³(SAE heaped) bucket and 500mm(20") triple grouser shoe, and rear dozer blade down.

Load point height		Load radius								At max. reach		
		1.5m(5ft)		3.0m(10ft)		4.5m(15ft)		6.0m(20ft)		Capacity		Reach
												m(ft)
6.0m (20ft)	kg lb					*1770 *3900	*1770 *3900			*1820 *4010	*1820 *4010	5.62 (18.4)
4.5m (15ft)	kg lb					*1950 *4300	*1950 *4300			1750 3860	1420 3130	6.62 (21.7)
3.0m (10ft)	kg lb			*3160 *6970	*3160 *6970	*2410 *5310	*2410 *5310	2020 4450	1640 3620	1480 3260	1180 2600	7.10 (23.3)
1.5m (5ft)	kg lb			*4940 *10890	*4940 *10890	*3060 *6750	2550 5620	1940 4280	1560 3440	1410 3110	1120 2470	7.18 (23.6)
Ground Line	kg lb			*5870 *12940	4580 10100	2970 6550	2370 5220	1860 4100	1480 3260	1490 3280	1180 2600	6.89 (22.6)
-1.5m (-5ft)	kg lb	*6090 *13430	*6090 *13430	*5860 *12920	4540 10010	2900 6390	2310 5090			1820 4010	1460 3220	6.15 (20.2)
-3.0m (-10ft)	kg lb	*9180 *20240	*9180 *20240	*5080 *11200	4670 10300	2980 6570	2380 5250					

(3) 4.3m(14' 1") boom, 2.81m(9' 3") arm equipped with 0.45m³(SAE heaped) bucket and 500mm(20") triple grouser shoe, and rear dozer blade down.

Load point height		Load radius								At max. reach		
		1.5m(5ft)		3.0m(10ft)		4.5m(15ft)		6.0m(20ft)		Capacity		Reach
												m(ft)
6.0m (20ft)	kg lb									*1570 *3460	*1520 *3350	6.66 (21.9)
4.5m (15ft)	kg lb							*1640 *3620	*1640 *3620	1450 3200	1170 2580	7.50 (24.6)
3.0m (10ft)	kg lb					*1920 *4230	*1920 *4230	*1830 *4030	1770 3900	1270 2800	1020 2250	7.92 (26.0)
1.5m (5ft)	kg lb			*4050 *8930	*4050 *8930	*2690 *5930	*2690 *5930	2050 4520	1670 3680	1210 2670	960 2120	7.99 (26.2)
Ground Line	kg lb	*3230 *7120	*3230 *7120	*5580 *12300	4910 10820	3130 6900	2530 5580	1950 4300	1570 3460	1290 2780	1000 2200	7.74 (25.4)
-1.5m (-5ft)	kg lb	*4960 *10930	*4960 *10930	6060 13360	4710 10380	3000 6610	2410 5310	1890 4170	1510 3330	1460 3220	1170 2580	7.11 (23.3)
-3.0m (-10ft)	kg lb	*7230 *15940	*7230 *15940	*5830 *12850	4720 10410	2980 6570	2390 5270			1990 4390	1610 3550	5.96 (19.6)
-4.5m (-15ft)	kg lb			*4480 *9880	*4480 *9880							

6. BUCKET SELECTION GUIDE

1) GENERAL BUCKET

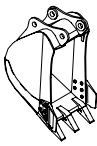
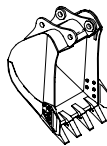
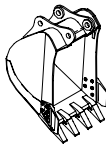
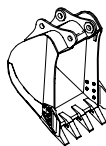
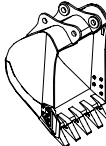
				
0.30m ³ SAE heaped bucket	0.40m ³ SAE heaped bucket	※ 0.45m ³ SAE heaped bucket	0.50m ³ SAE heaped bucket	0.59m ³ SAE heaped bucket

Capacity		Width		Weight	Recommendation		
					4.3m (14' 1") Mono boom		
SAE heaped	CECE heaped	Without side cutter	With side cutter		1.96m arm (6' 5")	2.26m arm (7' 5")	2.81m arm (9' 3")
0.30m ³ (0.39yd ³)	0.27m ³ (0.35yd ³)	610mm (24.0")	720mm (28.3")	360kg (790lb)			
0.40m ³ (0.52yd ³)	0.44m ³ (0.58yd ³)	760mm (29.9")	870mm (34.3")	410kg (900lb)			
※ 0.45m ³ (0.59yd ³)	0.40m ³ (0.52yd ³)	830mm (32.7")	940mm (37.0")	430kg (950lb)			
0.50m ³ (0.65yd ³)	0.45m ³ (0.59yd ³)	900mm (35.4")	1010mm (39.8")	450kg (990lb)			
0.59m ³ (0.77yd ³)	0.52m ³ (0.68yd ³)	1020mm (40.2")	1130mm (44.5")	490kg (1080lb)			

※ : Standard bucket

 Applicable for materials with density of 2000kg/m³ (3370lb/yd³) or less

 Applicable for materials with density of 1600kg/m³ (2700lb/yd³) or less

 Applicable for materials with density of 1100kg/m³ (1850lb/yd³) or less

7. UNDERCARRIAGE

1) TRACKS

X-leg type center frame is integrally welded with reinforced box-section track frames. The design includes dry tracks, lubricated rollers, idlers, sprockets, hydraulic track adjusters with shock absorbing springs and assembled track-type tractor shoes with triple grousers.

2) TYPES OF SHOES

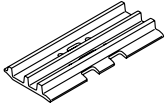
Model	Shapes		Triple grouser		
					
R110-7	Shoe width	mm(in)	500(20)	600(24)	700(28)
	Operating weight	kg(lb)	11200(24690)	11500(25350)	11800(26010)
	Ground pressure	kgf/cm ² (psi)	0.39(5.55)	0.34(4.84)	0.30(4.27)
	Overall width	mm(ft-in)	2490(8' 2")	2590(8' 6")	2690(8'10")
R110D-7	Shoe width	mm(ft-in)	500(20)	600(24)	700(28)
	Overall width	mm(ft-in)	11900(26230)	12200(26900)	12500(27560)
	Overall width	mm(ft-in)	0.42(5.97)	0.36(5.12)	0.31(4.41)
	Overall width	mm(ft-in)	2500(8' 2")	2590(8' 6")	2690(8'10")

3) NUMBER OF ROLLERS AND SHOES ON EACH SIDE

Item	Quantity
Carrier rollers	1EA
Track rollers	6EA
Track shoes	41EA

4) SELECTION OF TRACK SHOE

Suitable track shoes should be selected according to operating conditions.

Method of selecting shoes

Confirm the category from the list of applications in **table 2**, then use **table 1** to select the shoe. Wide shoes(Categories B) have limitations on applications. Before using wide shoes, check the precautions, then investigate and study the operating conditions to confirm if these shoes are suitable.

Select the narrowest shoe possible to meet the required flotation and ground pressure. Application of wider shoes than recommendations will cause unexpected problem such as bending of shoes, crack of link, breakage of pin, loosening of shoe bolts and the other various problems.

※ **Table 1**

Track shoe	Specification	Category
500mm triple grouser	Standard	A
600mm triple grouser	Option	A
700mm triple grouser	Option	B

※ **Table 2**

Category	Applications	Precautions
A	Rocky ground, river beds, normal soil	<ul style="list-style-type: none">• Travel at low speed on rough ground with large obstacles such as boulders or fallen trees
B	Normal soil, soft ground	<ul style="list-style-type: none">• These shoes cannot be used on rough ground with large obstacles such as boulders or fallen trees• Travel at high speed only on flat ground• Travel slowly at low speed if it is impossible to avoid going over obstacles

8. SPECIFICATIONS FOR MAJOR COMPONENTS

1) ENGINE

Item	Specification
Model	Kirlostar 4R1040T
Type	4-cycle turbocharged diesel engine, low emission
Cooling method	Water cooling
Number of cylinders and arrangement	4 cylinders, in-line
Firing order	1-3-4-2
Combustion chamber type	Direct injection type
Cylinder bore × stroke	105 × 120mm(4.1" × 4.7")
Piston displacement	4160cc(253.8cu in)
Compression ratio	17:1
Rated gross horse power(SAE J1995)	94Hp at 1950rpm(69.1kW at 1950rpm)
Maximum torque at 1400rpm	38.2kgf · m(276.6lb · ft)
Engine oil quantity	11.5 l (3.0U.S. gal)
Dry weight	550kg(1213lb)
High idling speed	2069+ 50rpm
Low idling speed	750 ± 50rpm
Rated fuel consumption	163.5g/Hp · hr at 1950rpm
Starting motor	LUCAS 24V-5.0kW
Alternator	MICO 24V-55A
Battery	2 × 12V × 80Ah

2) MAIN PUMP

Item	Specification
Type	Variable displacement tandem axis piston pumps
Capacity	2 × 57.5cc/rev
Maximum pressure	330kgf/cm ² (4694psi) [360kgf/cm ² (5120psi)]
Rated oil flow	2 × 112 l /min (2 × 29.6U.S.gpm)
Rated speed	1950rpm

[]: Poer boost

3) GEAR PUMP

Item	Specification
Type	Fixed displacement gear pump single stage
Capacity	15cc/rev
Maximum pressure	35kgf/cm ² (500psi)
Rated oil flow	29.3 l /min(7.7U.S.gpm/6.4U.K.gpm)

4) MAIN CONTROL VALVE

Item	Specification
Type	11 spools mono-block
Operating method	Hydraulic pilot system
Main relief valve pressure	330kgf/cm ² (4695psi)[360kgf/cm ² (5120psi)]
Overload relief valve pressure	380kgf/cm ² (5550psi)

[]: Pooer boost

5) SWING MOTOR

Item	Specification
Type	Axial piston motor
Capacity	64.3cc/rev
Relief pressure	240kgf/cm ² (3414psi)
Braking system	Automatic, spring applied hydraulic released
Braking torque	25kgf · m ² (181lbf · ft)
Brake release pressure	33~50kgf/cm ² (469~711psi)
Reduction gear type	2 - stage planetary
Swing speed	13.0rpm

6) TRAVEL MOTOR

Item	Specification
Type	Variable displacement axial piston motor
Relief pressure	330kgf/cm ² (4695psi)
Reduction gear type	2 stage planetary
Braking system	Automatic, spring applied hydraulic released
Brake release pressure	Less then 9kgf/cm ² (128psi)
Braking torque	24.36kgf · m ² (176lbf · ft)

7) REMOTE CONTROL VALVE

Item		Specification
Type		Pressure reducing type
Operating pressure	Minimum	6.5kgf/cm ² (92psi)
	Maximum	26kgf/cm ² (370psi)
Single operation stroke	Lever	61mm(2.4in)
	Pedal	123mm(4.84in)

8) CYLINDER

Item		Specification
Boom cylinder	Bore dia × Rod dia × Stroke	∅ 95 × ∅ 70 × 1015mm
	Cushion	Extend only
Arm cylinder	Bore dia × Rod dia × Stroke	∅ 110 × ∅ 75 × 1070mm
	Cushion	Extend and retract
Bucket cylinder	Bore dia × Rod dia × Stroke	∅ 95 × ∅ 65 × 855mm
	Cushion	Extend only
Dozer cylinder	Bore dia × Rod dia × Stroke	∅ 100 × ∅ 70 × 240mm
	Cushion	-

※ **Discoloration of cylinder rod can occur when the friction reduction additive of lubrication oil spreads on the rod surface.**

※ **Discoloration does not cause any harmful effect on the cylinder performance.**

9) SHOE

Item		Width	Ground pressure	Link quantity	Overall width
R110-7 R110D-7	Standard	500mm(20")	0.39kgf/cm ² (5.55psi)	41	2490mm(8' 2")
	Option	600mm(24")	0.34kgf/cm ² (4.84psi)	41	2590mm(8' 6")
	Option	700mm(28")	0.30kgf/cm ² (4.27psi)	41	2690mm(8' 10")

10) BUCKET

Item		Capacity		Tooth quantity	Width	
		SAE heaped	CECE heaped		Without side cutter	With side cutter
R110-7 R110D-7	STD	0.45m ³ (0.59yd ³)	0.40m ³ (0.52yd ³)	4	830mm(32.7")	940mm(37.0")
	OPT	0.30m ³ (0.39yd ³)	0.27m ³ (0.35yd ³)	3	610mm(24.0")	720mm(28.3")
		0.40m ³ (0.52yd ³)	0.44m ³ (0.58yd ³)	4	760mm(29.9")	870mm(34.3")
		0.50m ³ (0.65yd ³)	0.45m ³ (0.59yd ³)	4	900mm(35.4")	1010mm(39.8")
		0.59m ³ (0.77yd ³)	0.52m ³ (0.68yd ³)	5	1020mm(40.2")	1130mm(44.5")

9. RECOMMENDED OILS

Use only oils listed below or equivalent.

Do not mix different brand oil.

Service point	Kind of fluid	Capacity l (U.S. gal)	Ambient temperature °C (°F)						
			-20 (-4)	-10 (14)	0 (32)	10 (50)	20 (68)	30 (86)	40 (104)
Engine oil pan	Engine oil	11.5(3.0)	SAE 30						
			SAE 10W						
			SAE 10W-30						
							SAE 15W-40		
Swing drive	Gear oil	2.5(0.7)	SAE 85W-140						
Final drive		$\frac{2.5 \times 2}{0.7 \times 2}$							
Swing drive	Grease	0.35(0.09)	NLGI NO.1						
					NLGI NO.2				
Hydraulic tank	Hydraulic oil	Tank:100(26.4) System: 210(55.5)	ISO VG 32						
						ISO VG 46			
					ISO VG 68				
Fuel tank	Diesel fuel	250(66.0)	ASTM D975 NO.1						
					ASTM D975 NO.2				
Fitting (Grease nipple)	Grease	As required	NLGI NO.1						
					NLGI NO.2				
Radiator (Reservoir tank)	Mixture of antifreeze and water 50 : 50	24(6.3)	Ethylene glycol base permanent type						

SAE : Society of Automotive Engineers

API : American Petroleum Institute

ISO : International Organization for Standardization

NLGI : National Lubricating Grease Institute

ASTM : American Society of Testing and Material