

SECTION 1 GENERAL



Group 1 Safety Hints	1-1
Group 2 Specifications	1-10

SECTION 1 GENERAL

GROUP 1 SAFETY

FOLLOW SAFE PROCEDURE

Unsafe work practices are dangerous. Understand service procedure before doing work; Do not attempt shortcuts.

WEAR PROTECTIVE CLOTHING

Wear close fitting clothing and safety equipment appropriate to the job.

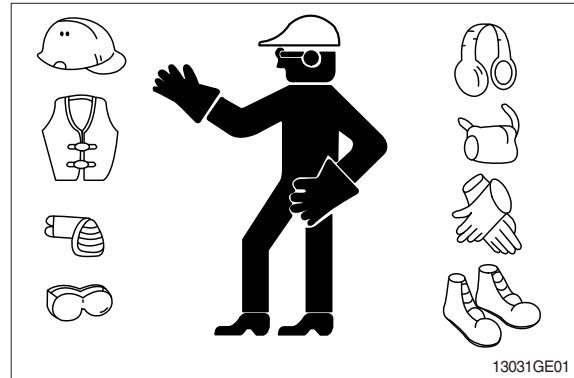

WARN OTHERS OF SERVICE WORK

Unexpected machine movement can cause serious injury.

Before performing any work on the excavator, attach a 「Do Not Operate」 tag on the right side control lever.

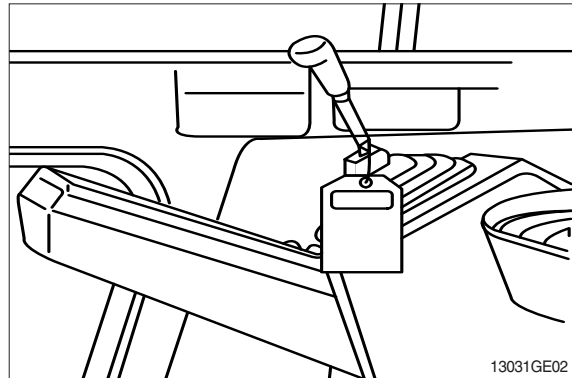

USE HANDHOLDS AND STEPS

Falling is one of the major causes of personal injury.

When you get on and off the machine, always maintain a three point contact with the steps and handrails and face the machine. Do not use any controls as handholds.

Never jump on or off the machine. Never mount or dismount a moving machine.

Be careful of slippery conditions on platforms, steps, and handrails when leaving the machine.

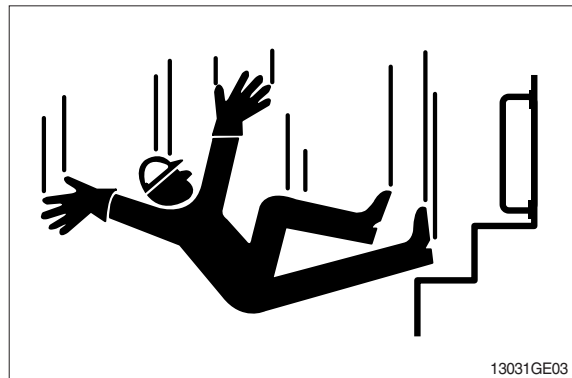

PREPARE FOR EMERGENCIES

Be prepared if a fire starts.

Keep a first aid kit and fire extinguisher handy.

Keep emergency numbers for doctors, ambulance service, hospital, and fire department near your telephone.

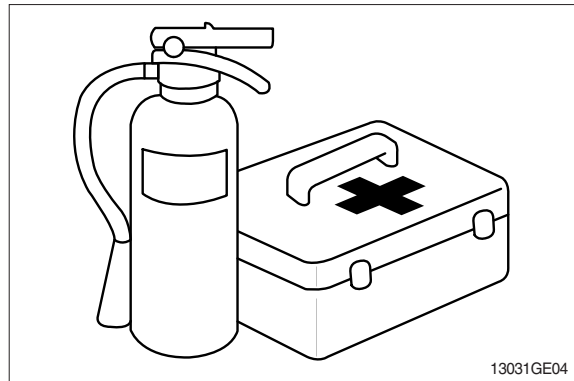

PROTECT AGAINST FLYING DEBRIS

Guard against injury from flying pieces of metal or debris; Wear goggles or safety glasses.

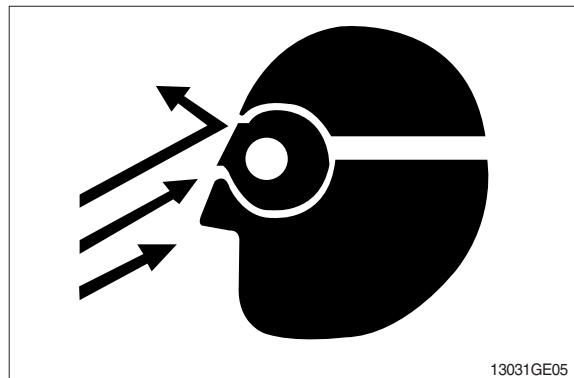

PROTECT AGAINST NOISE

Prolonged exposure to loud noise can cause impairment or loss of hearing.

Wear a suitable hearing protective device such as earmuffs or earplugs to protect against objectionable or uncomfortable loud noises.

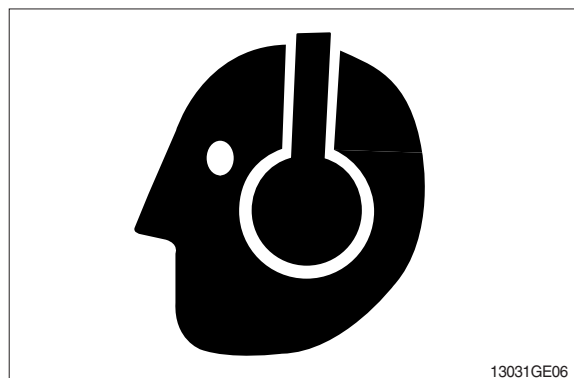

AVOID POWER LINES

Serious injury or death can result from contact with electric lines.

Never move any part of the machine or load closer to electric line than 3m(10ft) plus twice the line insulator length.

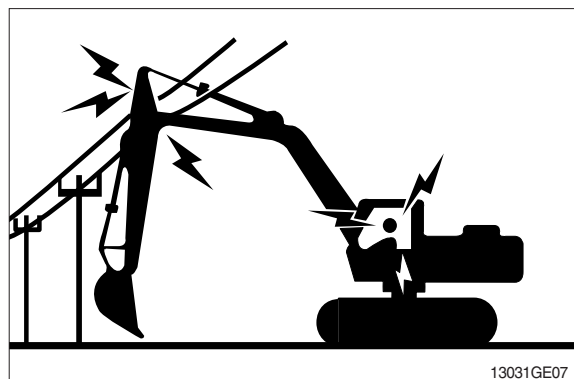

KEEP RIDERS OFF EXCAVATOR

Only allow the operator on the excavator. Keep riders off.

Riders on excavator are subject to injury such as being struck by foreign objects and being thrown off the excavator. Riders also obstruct the operator's view resulting in the excavator being operated in an unsafe manner.

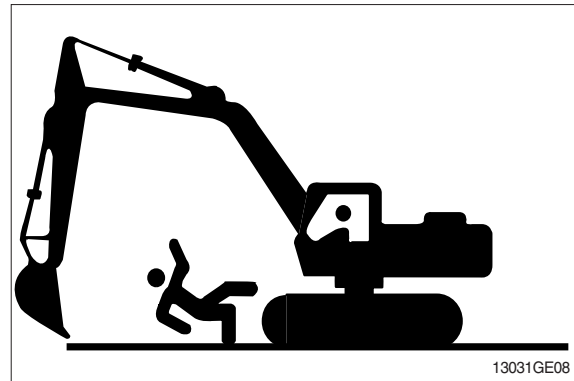

MOVE AND OPERATE MACHINE SAFELY

Bystanders can be run over. Know the location of bystanders before moving, swinging, or operating the machine.

Always keep the travel alarm in working condition. It warns people when the excavator starts to move.

Use a signal person when moving, swinging, or operating the machine in congested areas. Coordinate hand signals before starting the excavator.

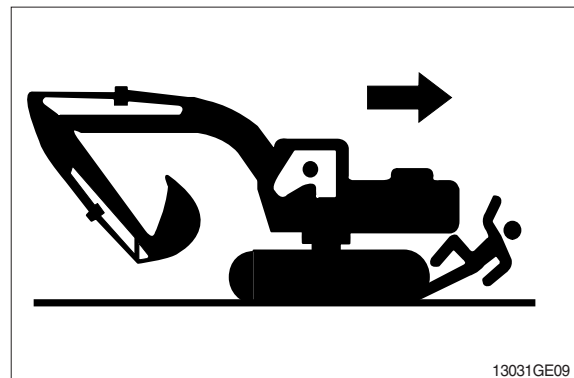

OPERATE ONLY FROM OPERATOR'S SEAT

Avoid possible injury machine damage. Do not start engine by shorting across starter terminals.

NEVER start engine while standing on ground. Start engine only from operator's seat.



PARK MACHINE SAFELY

Before working on the machine:

- Park machine on a level surface.
- Lower bucket to the ground.
- Turn auto idle switch off.
- Run engine at 1/2 speed without load for 2 minutes.
- Turn key switch to OFF to stop engine. Remove key from switch.
- Move pilot control shutoff lever to locked position.
- Allow engine to cool.

SUPPORT MACHINE PROPERLY

Always lower the attachment or implement to the ground before you work on the machine. If you must work on a lifted machine or attachment, securely support the machine or attachment.

Do not support the machine on cinder blocks, hollow tiles, or props that may crumble under continuous load.

Do not work under a machine that is supported solely by a jack. Follow recommended procedures in this manual.

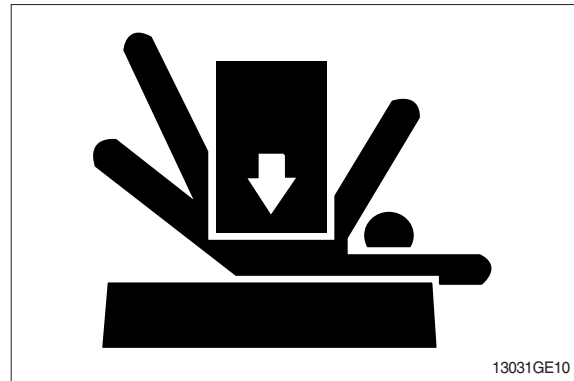

SERVICE COOLING SYSTEM SAFELY

Explosive release of fluids from pressurized cooling system can cause serious burns.

Shut off engine. Only remove filler cap when cool enough to touch with bare hands.

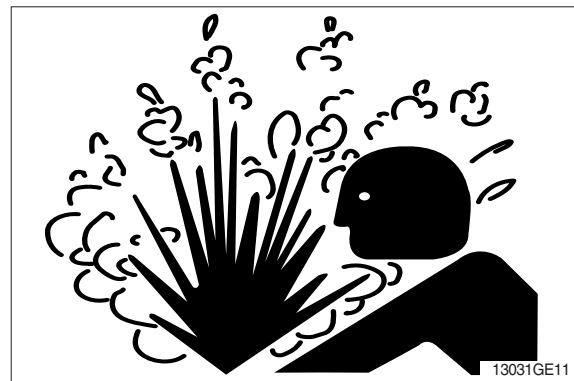

HANDLE FLUIDS SAFELY-AVOID FIRES

Handle fuel with care; It is highly flammable. Do not refuel the machine while smoking or when near open flame or sparks. Always stop engine before refueling machine. Fill fuel tank outdoors.



Store flammable fluids away from fire hazards. Do not incinerate or puncture pressurized containers.

Make sure machine is clean of trash, grease, and debris.

Do not store oily rags; They can ignite and burn spontaneously.

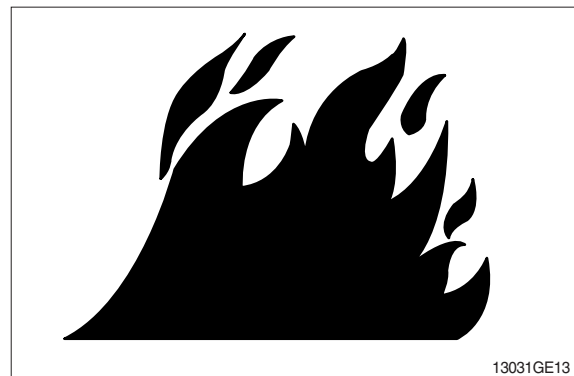

BEWARE OF EXHAUST FUMES

Prevent asphyxiation. Engine exhaust fumes can cause sickness or death.

If you must operate in a building, be positive there is adequate ventilation. Either use an exhaust pipe extension to remove the exhaust fumes or open doors and windows to bring enough outside air into the area.

REMOVE PAINT BEFORE WELDING OR HEATING

Avoid potentially toxic fumes and dust.

Hazardous fumes can be generated when paint is heated by welding, soldering, or using a torch.

Do all work outside or in a well ventilated area. Dispose of paint and solvent properly.

Remove paint before welding or heating:

- If you sand or grind paint, avoid breathing the dust.
Wear an approved respirator.
- If you use solvent or paint stripper, remove stripper with soap and water before welding. Remove solvent or paint stripper containers and other flammable material from area. Allow fumes to disperse at least 15 minutes before welding or heating.

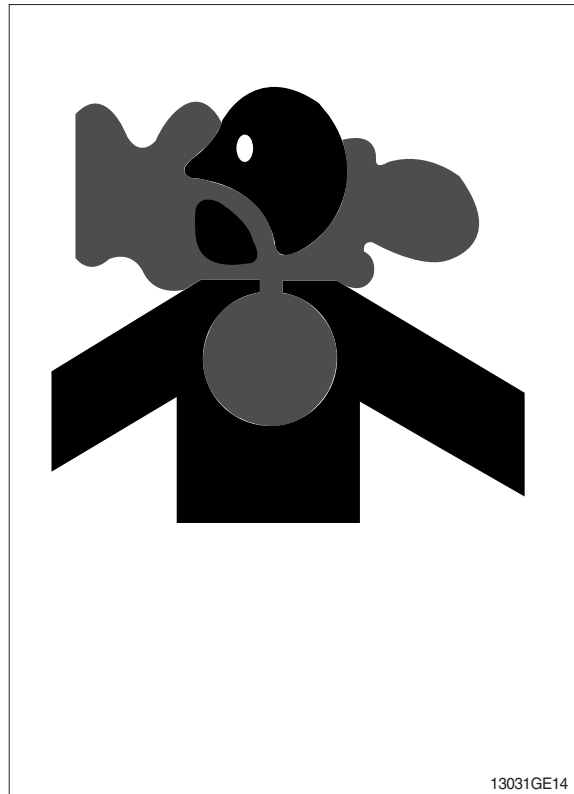

ILLUMINATE WORK AREA SAFELY

Illuminate your work area adequately but safely. Use a portable safety light for working inside or under the machine. Make sure the bulb is enclosed by a wire cage. The hot filament of an accidentally broken bulb can ignite spilled fuel or oil.



SERVICE MACHINE SAFELY

Tie long hair behind your head. Do not wear a necktie, scarf, loose clothing or necklace when you work near machine tools or moving parts. If these items were to get caught, severe injury could result.

Remove rings and other jewelry to prevent electrical shorts and entanglement in moving parts.

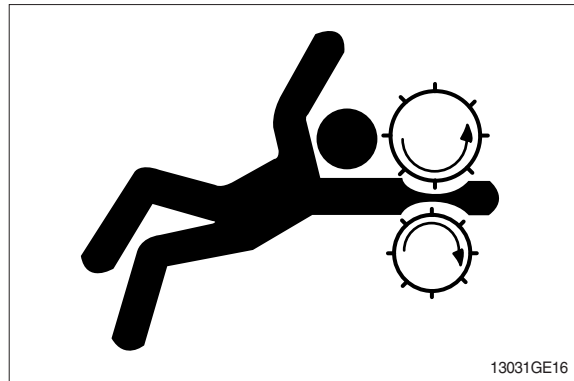

STAY CLEAR OF MOVING PARTS

Entanglements in moving parts can cause serious injury.

To prevent accidents, use care when working around rotating parts.

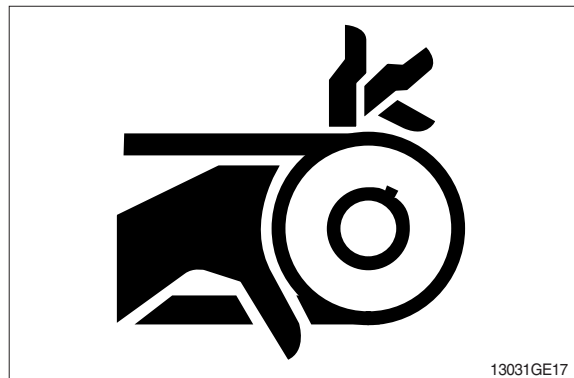

AVOID HIGH PRESSURE FLUIDS

Escaping fluid under pressure can penetrate the skin causing serious injury.

Avoid the hazard by relieving pressure before disconnecting hydraulic or other lines. Tighten all connections before applying pressure.

Search for leaks with a piece of cardboard. Protect hands and body from high pressure fluids.

If an accident occurs, see a doctor immediately. Any fluid injected into the skin must be surgically removed within a few hours or gangrene may result.

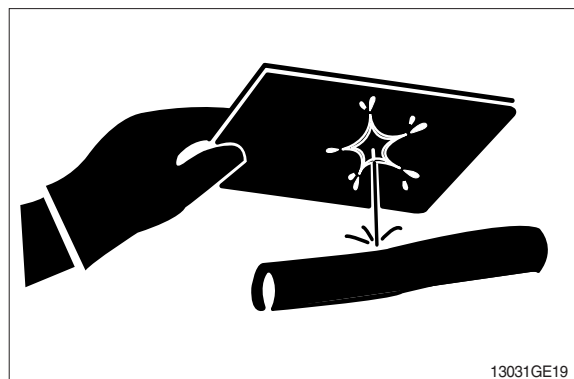

AVOID HEATING NEAR PRESSURIZED FLUID LINES

Flammable spray can be generated by heating near pressurized fluid lines, resulting in severe burns to yourself and bystanders. Do not heat by welding, soldering, or using a torch near pressurized fluid lines or other flammable materials.

Pressurized lines can be accidentally cut when heat goes beyond the immediate flame area. Install fire resisting guards to protect hoses or other materials.



PREVENT BATTERY EXPLOSIONS

Keep sparks, lighted matches, and flame away from the top of battery. Battery gas can explode.

Never check battery charge by placing a metal object across the posts. Use a volt-meter or hydrometer.

Do not charge a frozen battery; It may explode. Warm battery to 16°C (60°F).



PREVENT ACID BURNS

Sulfuric acid in battery electrolyte is poisonous. It is strong enough to burn skin, eat holes in clothing, and cause blindness if splashed into eyes.

Avoid the hazard by:

1. Filling batteries in a well-ventilated area.
2. Wearing eye protection and rubber gloves.
3. Avoiding breathing fumes when electrolyte is added.
4. Avoiding spilling or dripping electrolyte.
5. Use proper jump start procedure.

If you spill acid on yourself:

1. Flush your skin with water.
2. Apply baking soda or lime to help neutralize the acid.
3. Flush your eyes with water for 10-15 minutes. Get medical attention immediately.

If acid is swallowed:

1. Drink large amounts of water or milk.
2. Then drink milk of magnesia, beaten eggs, or vegetable oil.
3. Get medical attention immediately.

USE TOOLS PROPERLY

Use tools appropriate to the work. Makeshift tools, parts, and procedures can create safety hazards.

Use power tools only to loosen threaded tools and fasteners.

For loosening and tightening hardware, use the correct size tools. **DO NOT** use U.S. measurement tools on metric fasteners. Avoid bodily injury caused by slipping wrenches.

Use only recommended replacement parts. (See Parts catalogue.)

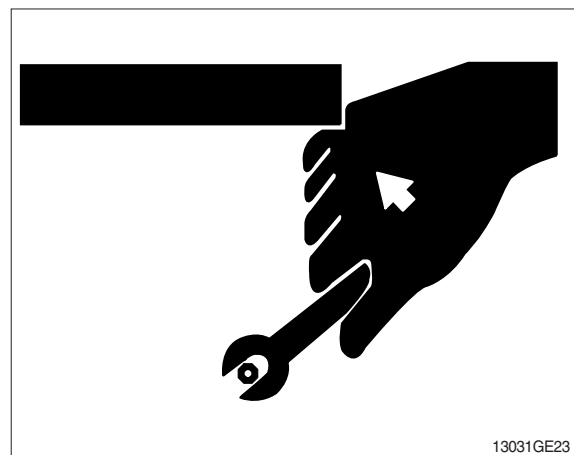
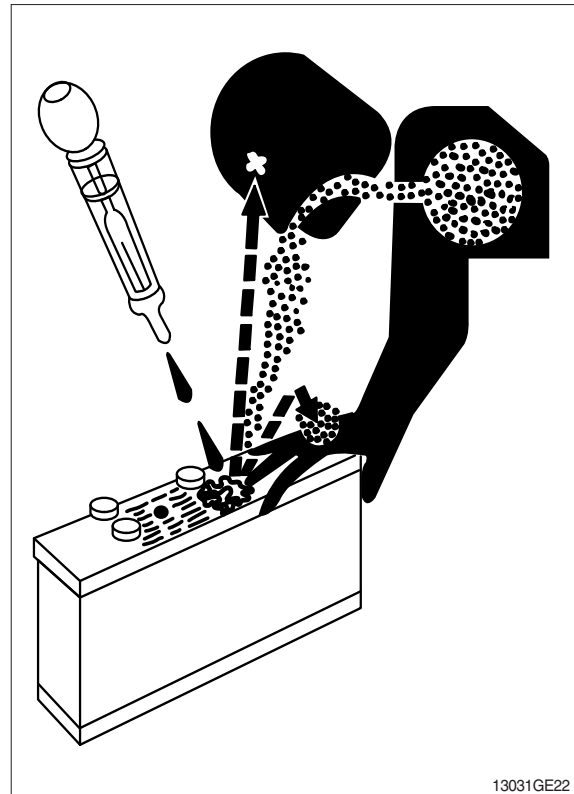

DISPOSE OF FLUIDS PROPERLY

Improperly disposing of fluids can harm the environment and ecology. Before draining any fluids, find out the proper way to dispose of waste from your local environmental agency.

Use proper containers when draining fluids. Do not use food or beverage containers that may mislead someone into drinking from them.

DO NOT pour oil into the ground, down a drain, or into a stream, pond, or lake. Observe relevant environmental protection regulations when disposing of oil, fuel, coolant, brake fluid, filters, batteries, and other harmful waste.

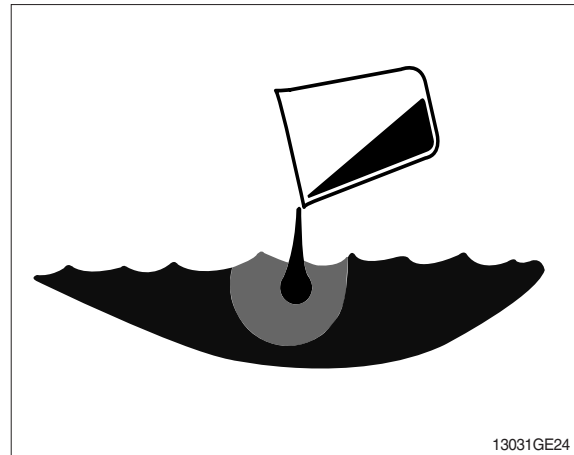

REPLACE SAFETY SIGNS

Replace missing or damaged safety signs. See the machine operator's manual for correct safety sign placement.

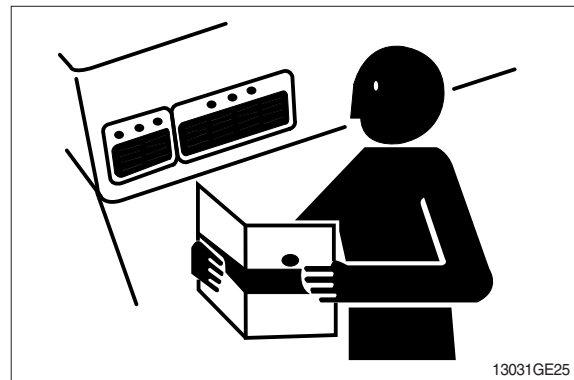

LIVE WITH SAFETY

Before returning machine to customer, make sure machine is functioning properly, especially the safety systems. Install all guards and shields.

GROUP 2 SPECIFICATIONS

1. MAJOR COMPONENT

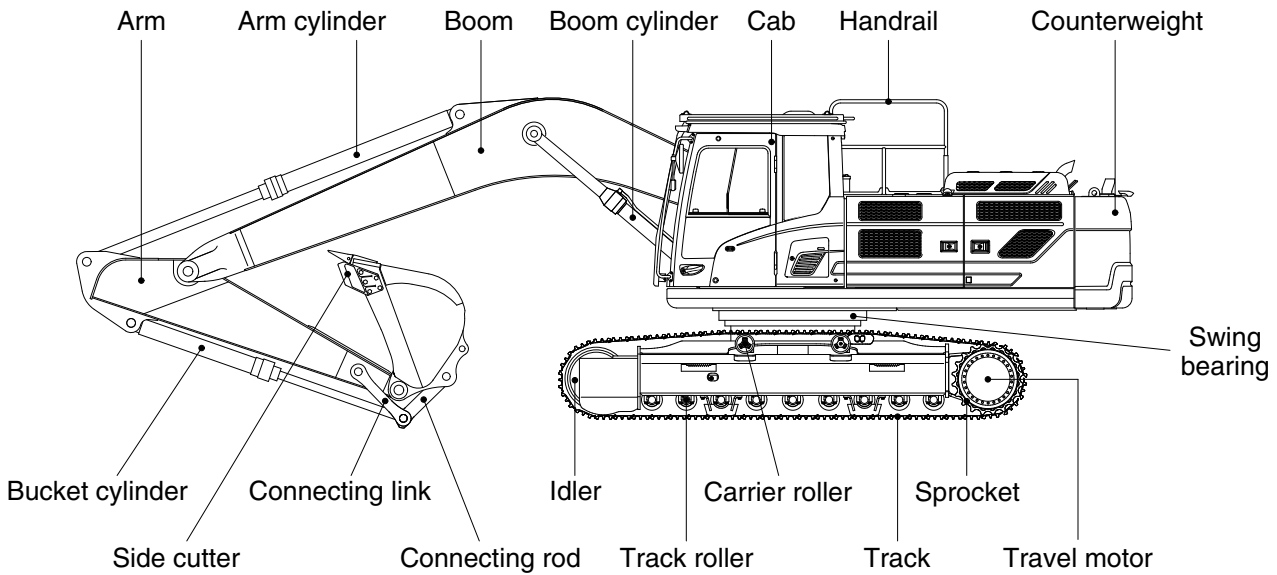
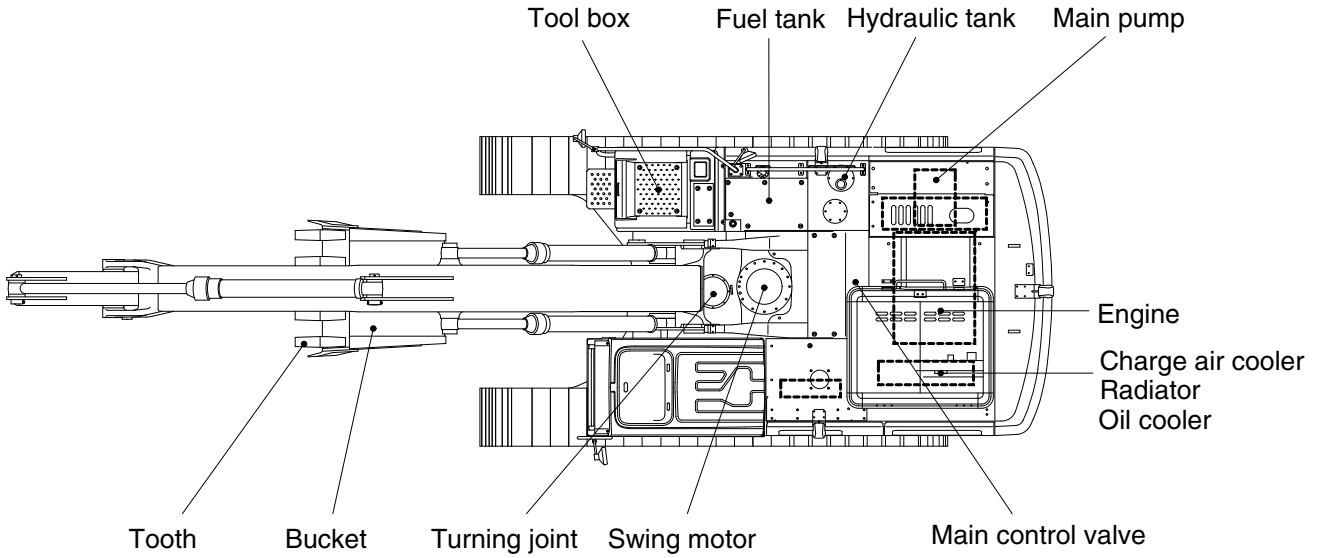

340S2SP01

2. SPECIFICATIONS

1)HX340S L

(1) 6.45 m (21' 2") boom and 3.20 m (10' 6") arm

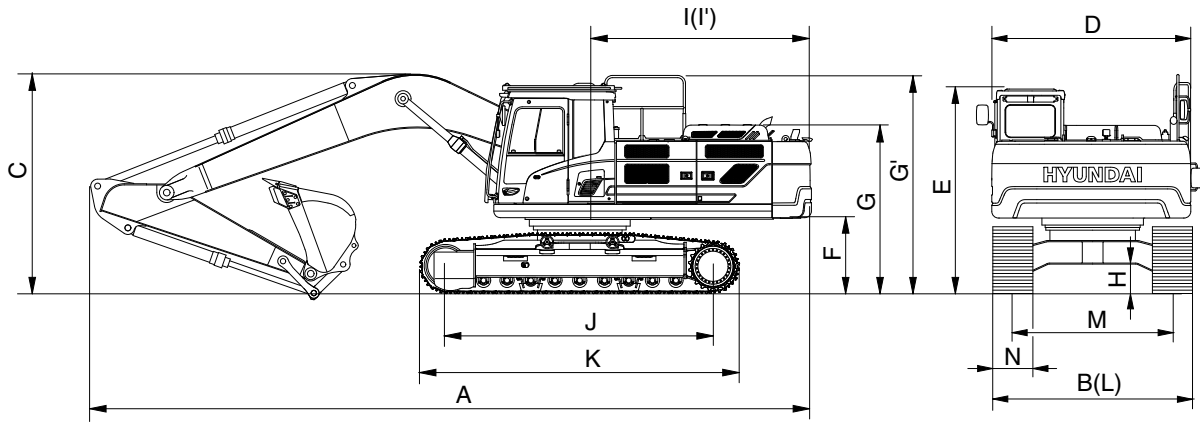

330S2SP02

Description		Unit	Specification
Operating weight		kg (lb)	33000 (72750)
Bucket capacity (SAE heaped), standard		m ³ (yd ³)	1.44 (1.88)
Overall length	A	mm (ft-in)	11220 (36' 10")
Overall width, with 600 mm shoe	B		3280 (10' 9")
Overall height of boom	C		3360 (11' 0")
Superstructure width	D		2980 (9' 9")
Overall height of cab	E		3145 (10' 4")
Ground clearance of counterweight	F		1200 (3' 11")
Overall height of engine hood	G		2672 (8' 9")
Overall height of handrail	G'		3350 (11' 0")
Minimum ground clearance	H		500 (1' 8")
Rear-end distance	I		3510 (11' 6")
Rear-end swing radius	I'		3570 (11' 9")
Distance between tumblers	J		4030 (13' 3")
Undercarriage length	K		4940 (16' 2")
Undercarriage width	L		3280 (10' 9")
Track gauge	M		2680 (8' 10")
Track shoe width, standard	N		600 (24")
Travel speed (low/high)		km/hr (mph)	3.6/6.4 (2.11/3.98)
Swing speed		rpm	11.2
Gradeability		Degree (%)	35 (70)
Ground pressure (600 mm shoe)		kgf/cm ² (psi)	0.64 (9.03)
Max traction force		kg (lb)	29500 (65030)

(2) 6.15 m (20' 2") boom and 2.2 m (7' 3") arm

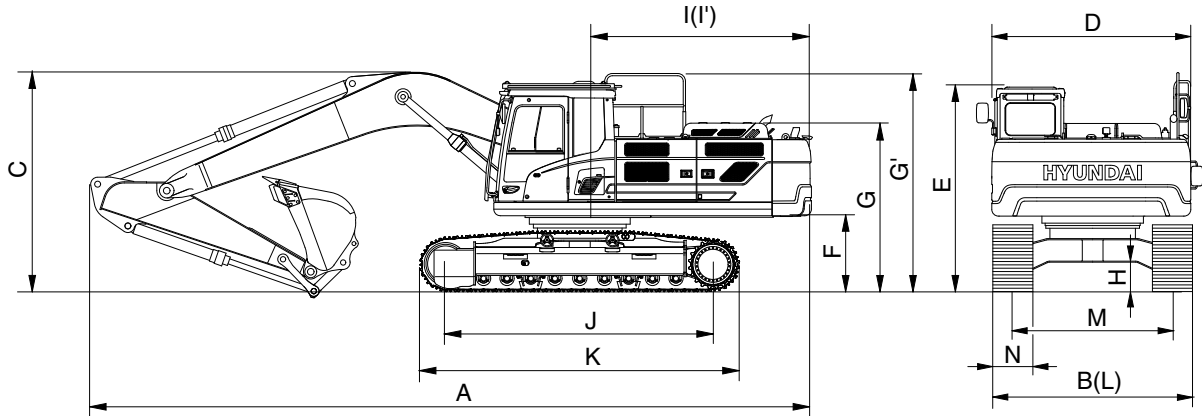

330S2SP02

Description	Unit	Specification
Operating weight	kg (lb)	32806 (72325)
Bucket capacity (SAE heaped), standard	m ³ (yd ³)	1.44 (1.88)
Overall length	A	11170 (36' 8")
Overall width, with 600 mm shoe	B	3280 (10' 9")
Overall height of boom	C	3680 (12' 1")
Superstructure width	D	2980 (9' 9")
Overall height of cab	E	3145 (10' 4")
Ground clearance of counterweight	F	1200 (3' 11")
Overall height of engine hood	G	2672 (8' 9")
Overall height of handrail	G'	3350 (11' 0")
Minimum ground clearance	H	500 (1' 8")
Rear-end distance	I	3510 (11' 6")
Rear-end swing radius	I'	3570 (11' 9")
Distance between tumblers	J	4030 (13' 3")
Undercarriage length	K	4940 (16' 2")
Undercarriage width	L	3280 (10' 9")
Track gauge	M	2680 (8' 10")
Track shoe width, standard	N	600 (24")
Travel speed (low/high)	km/hr (mph)	3.6/6.4 (2.11/3.98)
Swing speed	rpm	11.2
Gradeability	Degree (%)	35 (70)
Ground pressure (600 mm shoe)	kgf/cm ² (psi)	0.63 (8.98)
Max traction force	kg (lb)	29500 (65030)

3. WORKING RANGE

1) HX340S L, GENERAL BUCKET

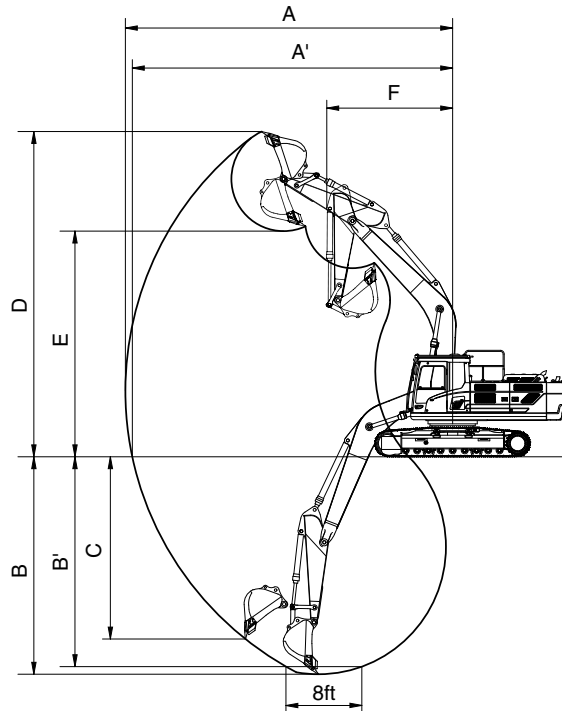

330S2SP05

Description	m (ft-in)	Boom	6.45 (21' 2")		
		Arm	2.50 (8' 2")	3.05 (10' 0")	4.05 (13' 3")
Max digging reach	mm (ft-in)	A	10500 (34' 5")	11150 (36' 7")	11950 (39' 2")
Max digging reach on ground		A'	10290 (33' 9")	10950 (35'11")	11770 (38' 7")
Max digging depth		B	6660 (21'10")	7360 (24' 2")	8210 (26'11")
Max digging depth (8 ft level)		B'	6450 (21' 2")	7200 (23' 7")	8080 (26' 6")
Max vertical wall digging depth		C	5660 (18' 7")	6330 (20' 9")	7240 (23' 9")
Max digging height		D	10050 (33' 0")	10360 (34' 0")	10780 (35' 4")
Max dumping height		E	6950 (22'10")	7260 (23'10")	7670 (25' 2")
Min swing radius		F	4440 (14' 7")	4360 (14' 4")	4290 (14' 1")
Bucket digging force	kN	SAE	187.3 [203.4]	188.3 [204.5]	189.3 [205.5]
	kgf		19100 [20740]	19200 [20850]	19300 [20950]
	lbf		42110 [45720]	42330 [45970]	42550 [46190]
	kN	ISO	215.7 [234.3]	216.7 [235.3]	217.7 [236.3]
	kgf		22000 [23890]	22100 [23990]	22200 [24100]
	lbf		48500 [52670]	48720 [52890]	48940 [53130]
Arm digging force	kN	SAE	175.5 [190.5]	1402.4 [1522.6]	118.7 [128.9]
	kgf		17900 [19430]	143000 [155260]	12100 [13140]
	lbf		39460 [42840]	315260 [342290]	26680 [28970]
	kN	ISO	184.4 [200.2]	145.1 [157.6]	123.6 [134.2]
	kgf		18800 [20410]	14800 [16070]	12600 [13680]
	lbf		41450 [45000]	32630 [35430]	27780 [30160]

[] : Power boost

2) HX340S L, HEAVY DUTY BUCKET

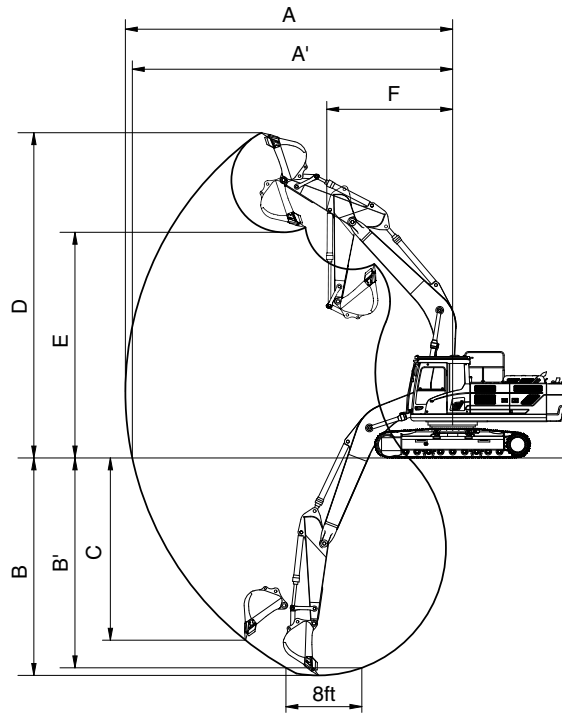

330S2SP05

Description	m (ft-in)	Boom	6.15 (20' 2")		6.45 (21' 2")	
		Arm	2.20 (7' 3")	2.50 (8' 2")	2.20 (7' 3")	2.50 (8' 2")
Max digging reach	mm (ft-in)	A	10020 (32' 10")	10190 (33' 5")	10330 (33' 11")	10500 (34' 5")
Max digging reach on ground		A'	9810 (32' 2")	9980 (32' 9")	10120 (33' 2")	10290 (33' 9")
Max digging depth		B	6150 (20' 2")	6450 (21' 2")	6360 (20' 10")	6660 (21' 10")
Max digging depth (8 ft level)		B'	5950 (19' 6")	6230 (20' 5")	6170 (20' 3")	6450 (21' 2")
Max vertical wall digging depth		C	5700 (18' 8")	5420 (17' 9")	5970 (19' 7")	5660 (18' 7")
Max digging height		D	9980 (32' 9")	9760 (32' 0")	10260 (33' 8")	10050 (33' 0")
Max dumping height		E	6790 (22' 3")	6670 (21' 11")	7060 (23' 2")	6950 (22' 10")
Min swing radius		F	4450 (14' 7")	4290 (14' 1")	4630 (15' 2")	4440 (14' 7")
Bucket digging force	kN	SAE	200.1 [217.2]	187.3 [203.4]	200.1 [217.2]	187.3 [203.4]
	kgf		20400 [22150]	19100 [20740]	20400 [22150]	19100 [20740]
	lbf		44970 [48830]	42110 [45720]	44970 [48830]	42110 [45720]
	kN	ISO	230.5 [250.2]	215.7 [234.3]	230.5 [250.2]	215.7 [234.3]
	kgf		23500 [25510]	22000 [23890]	23500 [25510]	22000 [23890]
	lbf		51810 [56240]	48500 [52670]	51810 [56240]	48500 [52670]
Arm digging force	kN	SAE	220.7 [239.6]	198.1 [215.1]	220.7 [239.6]	198.1 [215.1]
	kgf		22500 [24430]	20200 [21930]	22500 [24430]	20200 [21930]
	lbf		49600 [53860]	44530 [48350]	49600 [53860]	44530 [48350]
	kN	ISO	231.4 [251.3]	207.9 [225.8]	231.4 [251.3]	207.9 [225.8]
	kgf		23600 [25620]	21200 [23020]	23600 [25620]	21200 [23020]
	lbf		52030 [56480]	46740 [50750]	52030 [56480]	46740 [50750]

[] : Power boost

4. WEIGHT

1)HX340S L

Item	HX340S L	
	kg	lb
Upperstructure assembly	15420	33995
Main frame weld assembly	3910	8620
Engine assembly	604	1332
Main pump assembly	201	443
Main control valve assembly	220	485
Swing motor assembly	370	820
Hydraulic oil tank assembly	300	661
Fuel tank assembly	350	772
Counterweight	6000	13230
Cab assembly	422	930
Radiator assy	230	510
Oil cooler assy	80	180
Lower chassis assembly	11500	25350
Track frame weld assembly	3970	8750
Swing bearing	470	1040
Travel motor assembly	440	970
Turning joint	54	119
Tension cylinder	225	496
Idler	250	551
Sprocket	83	183
Carrier roller	35	77
Track roller	56	123
Track-chain assembly (600 mm standard triple grouser shoe)	1880	4145
Front attachment assembly (6.45 m boom, 3.2 m arm, 1.44 m ³ SAE heaped bucket)	6580	14510
6.45 m boom assembly	2560	5640
3.2 m arm assembly	1170	2580
1.44 m ³ SAE heaped bucket	1230	2710
Boom cylinder assembly	305	670
Arm cylinder assembly	380	840
Bucket cylinder assembly	265	580
Bucket control linkage assembly	370	820

5. LIFTING CAPACITIES

1) HX340S L









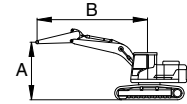

Unit : mm

Model	Boom	Boom	Arm	Counterweight	Shoe	Dozer		Outrigger	
	Type	Length	Length	Weight (kg)	Width	Front	Rear	Front	Rear
HX340S L	Mono	6450	2500	6000	600	-	-	-	-

·  : Rating over-front

·  : Rating over-side or 360 degree



Load point height	Load radius								At max. reach			
	3.0 m (9.8 ft)		4.5 m (14.8 ft)		6.0 m (19.7 ft)		7.5 m (24.6 ft)		Capacity		Reach	
											m (ft)	
7.5m 24.6ft	kg lb									*8810 *19420	7590 16730	6.93 (22.7)
6.0m 19.7ft	kg lb					*9300 *20500	*9300 *20500	*8710 *19200	6590 14530	*8710 *19200	6020 13270	7.90 (25.9)
4.5m 14.8ft	kg lb			*13700 *30200	*13700 *30200	*10600 *23370	9030 19910	*9200 *20280	6410 14130	7870 17350	5240 11550	8.49 (27.9)
3.0m 9.8ft	kg lb					*12160 *26810	8520 18780	9370 20660	6170 13600	7330 16160	4840 10670	8.79 (28.8)
1.5m 4.9ft	kg lb					12800 28220	8110 17880	9130 20130	5950 13120	7180 15830	4720 10410	8.82 (28.9)
0.0m 0.0ft	kg lb			*15210 *33530	12000 26460	12550 27670	7900 17420	8980 19800	5810 12810	7400 16310	4840 10670	8.58 (28.2)
-1.5m -4.9ft	kg lb			*18300 *40340	12060 26590	12510 27580	7850 17310	8950 19730	5790 12760	8100 17860	5280 11640	8.06 (26.4)
-3.0m -9.8ft	kg lb	*21480 *47360	*21480 *47360	*16590 *36570	12270 27050	12640 27870	7970 17570			9680 21340	6270 13820	7.19 (23.6)
-4.5m -14.8ft	kg lb			*13240 *29190	12690 27980					*9980 *22000	8760 19310	5.80 (19.0)

※ Note

1. Lifting capacity are based on SAE J1097 and ISO 10567.
2. Lifting capacity of the ROBEX series does not exceed 75% of tipping load with the machine on firm, level ground or 87% of full hydraulic capacity.
3. The lift-point is bucket mounting pin on the arm (without bucket).
4. *indicates load limited by hydraulic capacity.

※ Lifting capacities are based upon a standard machine conditions.

Lifting capacities will vary with different work tools, ground conditions and attachments.

The difference between the weight of a work tool attachment must be subtracted.

Consult your Hyundai dealer regarding the lifting capacities for specific work tools and attachments.

▲ Failure to comply to the rated load can cause possible personal injury or property damage.

Make adjustments to the rated load as necessary for non-standard configurations.

Unit : mm

Model	Boom	Boom	Arm	Counterweight	Shoe	Dozer		Outrigger	
	Type	Length	Length	Weight (kg)	Width	Front	Rear	Front	Rear
HX340S L	Mono	6450	3200	6000	600	-	-	-	-



: Rating over-front



: Rating over-side or 360 degree

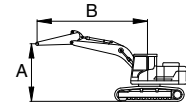

Load point height		Load radius										At max. reach		
		3.0 m (9.8 ft)		4.5 m (14.8 ft)		6.0 m (19.7 ft)		7.5 m (24.6 ft)		9.0 m (29.5 ft)		Capacity		Reach
														m (ft)
7.5m	kg							*6830	6790			*5610	*5610	7.74
24.6ft	lb							*15060	14970			*12370	*12370	(25.4)
6.0m	kg							*7850	6720			*5430	5270	8.62
19.7ft	lb							*17310	14820			*11970	11620	(28.3)
4.5m	kg			*11970	*11970	*9640	9230	*8500	6510	*6660	4810	*5450	4650	9.17
14.8ft	lb			*26390	*26390	*21250	20350	*18740	14350	*14680	10600	*12020	10250	(30.1)
3.0m	kg			*15500	13260	*11320	8690	*9370	6240	7090	4690	*5650	4330	9.44
9.8ft	lb			*34170	29230	*24960	19160	*20660	13760	15630	10340	*12460	9550	(31.0)
1.5m	kg			*17440	12360	*12820	8210	9170	5970	6950	4560	*6050	4220	9.47
4.9ft	lb			*38450	27250	*28260	18100	20220	13160	15320	10050	*13340	9300	(31.1)
0.0m	kg			*17250	11990	12580	7910	8960	5790	6860	4470	6590	4300	9.25
0.0ft	lb			*38030	26430	27730	17440	19750	12760	15120	9850	14530	9480	(30.4)
-1.5m	kg	*10800	*10800	*18850	11930	12440	7790	8870	5700			7100	4620	8.77
-4.9ft	lb	*23810	*23810	*41560	26300	27430	17170	19550	12570			15650	10190	(28.8)
-3.0m	kg	*17460	*17460	*17650	12060	12490	7830	8920	5750			8190	5320	7.98
-9.8ft	lb	*38490	*38490	*38910	26590	27540	17260	19670	12680			18060	11730	(26.2)
-4.5m	kg	*20530	*20530	*15150	12380	*11380	8060					*9570	6870	6.76
-14.8ft	lb	*45260	*45260	*33400	27290	*25090	17770					*21100	15150	(22.2)

Unit : mm

Model	Boom	Boom	Arm	Counterweight	Shoe	Dozer		Outrigger	
	Type	Length	Length	Weight (kg)	Width	Front	Rear	Front	Rear
HX340S L	Mono	6450	4050	6000	600	-	-	-	-



: Rating over-front



: Rating over-side or 360 degree

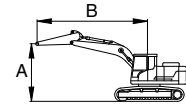

Load point height	Load radius												At max. reach			
	1.5 m (4.9 ft)		3.0 m (9.8 ft)		4.5 m (14.8 ft)		6.0 m (19.7 ft)		7.5 m (24.6 ft)		9.0 m (29.5 ft)		Capacity		Reach	
															m (ft)	
9.0m 29.5ft	kg									*4710	*4710			*4520	*4520	7.55
	lb									*10380	*10380			*9960	*9960	(24.8)
7.5m 24.6ft	kg													*4190	*4190	8.72
	lb													*9240	*9240	(28.6)
6.0m 19.7ft	kg									*6790	*6790	*5810	4970	*4060	*4060	9.50
	lb									*14970	*14970	*12810	10960	*8950	*8950	(31.2)
4.5m 14.8ft	kg									*7530	6610	*7110	4860	*4070	4000	10.00
	lb									*16600	14570	*15670	10710	*8970	8820	(32.8)
3.0m 9.8ft	kg				*13300	*13300	*10090	8870	*8510	6290	7110	4700	*4200	3750	10.25	
	lb				*29320	*29320	*22240	19550	*18760	13870	15670	10360	*9260	8270	(33.6)	
1.5m 4.9ft	kg				*16510	12630	*11820	8290	9190	5980	6920	4520	*4450	3650	10.28	
	lb				*36400	27840	*26060	18280	20260	13180	15260	9960	*9810	8050	(33.7)	
0.0m 0.0ft	kg			*6350	*6350	*18350	11980	12570	7880	8910	5720	6770	4380	*4870	3690	10.08
	lb			*14000	*14000	*40450	26410	27710	17370	19640	12610	14930	9660	*10740	8140	(33.1)
-1.5m -4.9ft	kg	*6460	*6460	*9880	*9880	*18870	11730	12310	7650	8740	5570	6690	4300	*5560	3910	9.64
	lb	*14240	*14240	*21780	*21780	*41600	25860	27140	16870	19270	12280	14750	9480	*12260	8620	(31.6)
-3.0m -9.8ft	kg	*10370	*10370	*14460	*14460	*18330	11740	12260	7600	8700	5540			*6720	4380	8.92
	lb	*22860	*22860	*31880	*31880	*40410	25880	27030	16760	19180	12210			*14820	9660	(29.3)
-4.5m -14.8ft	kg	*15020	*15020	*20810	*20810	*16670	11950	12390	7720	8840	5670			8290	5340	7.86
	lb	*33110	*33110	*45880	*45880	*36750	26350	27320	17020	19490	12500			18280	11770	(25.8)
-6.0m -19.7ft	kg			*18330	*18330	*13230	12410	*9500	8090					*8840	7650	6.26
	lb			*40410	*40410	*29170	27360	*20940	17840					*19490	16870	(20.5)









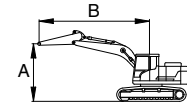

Unit : mm

Model	Boom	Boom	Arm	Counterweight	Shoe	Dozer		Outrigger	
	Type	Length	Length	Weight (kg)	Width	Front	Rear	Front	Rear
HX340S L	Mono	6450	2500	6600	600	-	-	-	-

·  : Rating over-front

·  : Rating over-side or 360 degree



Load point height		Load radius								At max. reach		
		3.0 m (9.8 ft)		4.5 m (14.8 ft)		6.0 m (19.7 ft)		7.5 m (24.6 ft)		Capacity		Reach
												m (ft)
7.5m 24.6ft	kg lb									*8810 *19420	7970 17570	6.93 (22.7)
6.0m 19.7ft	kg lb					*9300 *20500	*9300 *20500	*8710 *19200	6930 15280	*8710 *19200	6340 13980	7.90 (25.9)
4.5m 14.8ft	kg lb			*13700 *30200	*13700 *30200	*10600 *23370	9480 20900	*9200 *20280	6760 14900	8230 18140	5530 12190	8.49 (27.9)
3.0m 9.8ft	kg lb					*12160 *26810	8970 19780	9800 21610	6510 14350	7670 16910	5130 11310	8.79 (28.8)
1.5m 4.9ft	kg lb					13390 29520	8570 18890	9550 21050	6290 13870	7520 16580	5000 11020	8.82 (28.9)
0.0m 0.0ft	kg lb			*15210 *33530	12680 27950	13140 28970	8350 18410	9400 20720	6150 13560	7750 17090	5130 11310	8.58 (28.2)
-1.5m -4.9ft	kg lb			*18300 *40340	12740 28090	13090 28860	8310 18320	9380 20680	6130 13510	8480 18700	5590 12320	8.06 (26.4)
-3.0m -9.8ft	kg lb	*21480 *47360	*21480 *47360	*16590 *36570	12940 28530	*12720 *28040	8430 18580			*10110 *22290	6630 14620	7.19 (23.6)
-4.5m -14.8ft	kg lb			*13240 *29190	*13240 *29190					*9980 *22000	9230 20350	5.80 (19.0)









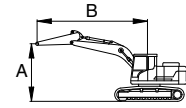



Unit : mm

Model	Boom	Boom	Arm	Counterweight	Shoe	Dozer		Outrigger	
	Type	Length	Length	Weight (kg)	Width	Front	Rear	Front	Rear
HX340S L	Mono	6450	3200	6600	600	-	-	-	-

·  : Rating over-front

·  : Rating over-side or 360 degree



Load point height		Load radius										At max. reach		
		3.0 m (9.8 ft)		4.5 m (14.8 ft)		6.0 m (19.7 ft)		7.5 m (24.6 ft)		9.0 m (29.5 ft)		Capacity		Reach
														m (ft)
7.5m 24.6ft	kg lb							*6830 *15060	*6830 *15060			*5610 *12370	*5610 *12370	7.74 (25.4)
6.0m 19.7ft	kg lb							*7800 *17200	7060 15560			*5430 *11970	*5430 *11970	8.62 (28.3)
4.5m 14.8ft	kg lb			*11900 *26230	*11900 *26230	*9580 *21120	*9580 *21120	*8430 *18580	6830 15060	*6660 *14680	5050 11130	*5450 *12020	4880 10760	9.17 (30.1)
3.0m 9.8ft	kg lb			*15380 *33910	13880 30600	*11230 *24760	9100 20060	*9280 *20460	6540 14420	7400 16310	4920 10850	*5650 *12460	4550 10030	9.44 (31.0)
1.5m 4.9ft	kg lb			*17450 *38470	12920 28480	*12700 *28000	8590 18940	9550 21050	6260 13800	7250 15980	4790 10560	*6050 *13340	4430 9770	9.47 (31.1)
0.0m 0.0ft	kg lb			*17260 *38050	12530 27620	13090 28860	8270 18230	9330 20570	6060 13360	7140 15740	4690 10340	*6720 *14820	4510 9940	9.25 (30.4)
-1.5m -4.9ft	kg lb	*10800 *23810	*10800 *23810	*18640 *41090	12460 27470	12940 28530	8140 17950	9230 20350	5970 13160			7390 16290	4840 10670	8.77 (28.8)
-3.0m -9.8ft	kg lb	*17460 *38490	*17460 *38490	*17440 *38450	12580 27730	12990 28640	8180 18030	9280 20460	6020 13270			8530 18810	5560 12260	7.98 (26.2)
-4.5m -14.8ft	kg lb	*20250 *44640	*20250 *44640	*14950 *32960	12910 28460	*11230 *24760	8410 18540					*9440 *20810	7180 15830	6.76 (22.2)

Unit : mm

Model	Boom	Boom	Arm	Counterweight	Shoe	Dozer		Outrigger	
	Type	Length	Length	Weight (kg)	Width	Front	Rear	Front	Rear
HX340S L	Mono	6450	4050	6600	600	-	-	-	-



: Rating over-front



: Rating over-side or 360 degree

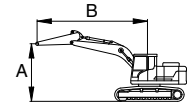

Load point height	Load radius												At max. reach			
	1.5 m (4.9 ft)		3.0 m (9.8 ft)		4.5 m (14.8 ft)		6.0 m (19.7 ft)		7.5 m (24.6 ft)		9.0 m (29.5 ft)		Capacity		Reach	
															m (ft)	
9.0m 29.5ft	kg									*4710	*4710			*4520	*4520	7.55
	lb									*10380	*10380			*9960	*9960	(24.8)
7.5m 24.6ft	kg													*4190	*4190	8.72
	lb													*9240	*9240	(28.6)
6.0m 19.7ft	kg									*6790	*6790	*5810	5240	*4060	*4060	9.50
	lb									*14970	*14970	*12810	11550	*8950	*8950	(31.2)
4.5m 14.8ft	kg									*7530	6950	*7110	5130	*4070	*4070	10.00
	lb									*16600	15320	*15670	11310	*8970	*8970	(32.8)
3.0m 9.8ft	kg				*13300	*13300	*10090	9320	*8510	6630	7440	4970	*4200	3980	10.25	
	lb				*29320	*29320	*22240	20550	*18760	14620	16400	10960	*9260	8770	(33.6)	
1.5m 4.9ft	kg				*16510	13310	*11820	8750	*9500	6320	7260	4800	*4450	3880	10.28	
	lb				*36400	29340	*26060	19290	*20940	13930	16010	10580	*9810	8550	(33.7)	
0.0m 0.0ft	kg			*6350	*6350	*18350	12660	*13100	8330	9330	6070	7100	4650	*4870	3930	10.08
	lb			*14000	*14000	*40450	27910	*28880	18360	20570	13380	15650	10250	*10740	8660	(33.1)
-1.5m -4.9ft	kg	*6460	*6460	*9880	*9880	*18870	12410	12900	8110	9170	5920	7020	4580	*5560	4170	9.64
	lb	*14240	*14240	*21780	*21780	*41600	27360	28440	17880	20220	13050	15480	10100	*12260	9190	(31.6)
-3.0m -9.8ft	kg	*10370	*10370	*14460	*14460	*18330	12410	12840	8060	9130	5880			*6720	4660	8.92
	lb	*22860	*22860	*31880	*31880	*40410	27360	28310	17770	20130	12960			*14820	10270	(29.3)
-4.5m -14.8ft	kg	*15020	*15020	*20810	*20810	*16670	12620	*12500	8180	9270	6010			*8690	5660	7.86
	lb	*33110	*33110	*45880	*45880	*36750	27820	*27560	18030	20440	13250			*19160	12480	(25.8)
-6.0m -19.7ft	kg			*18330	*18330	*13230	13080	*9500	8550					*8840	8080	6.26
	lb			*40410	*40410	*29170	28840	*20940	18850					*19490	17810	(20.5)









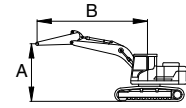

Unit : mm

Model	Boom	Boom	Arm	Counterweight	Shoe	Dozer		Outrigger	
	Type	Length	Length	Weight (kg)	Width	Front	Rear	Front	Rear
HX340S L	Heavy duty	6150	2200	6600	600	-	-	-	-

·  : Rating over-front

·  : Rating over-side or 360 degree



Load point height		Load radius								At max. reach		
		3.0 m (9.8 ft)		4.5 m (14.8 ft)		6.0 m (19.7 ft)		7.5 m (24.6 ft)		Capacity		Reach
												m (ft)
7.5m 24.6ft	kg lb					*9650 *21270	*9650 *21270			*9790 *21580	9210 20300	6.31 (20.7)
6.0m 19.7ft	kg lb					*9850 *21720	*9850 *21720			*9550 *21050	7070 15590	7.36 (24.2)
4.5m 14.8ft	kg lb					*10990 *24230	9530 21010	*9690 *21360	6760 14900	9060 19970	6080 13400	8.00 (26.2)
3.0m 9.8ft	kg lb					*12440 *27430	9040 19930	9850 21720	6550 14440	8390 18500	5600 12350	8.31 (27.3)
1.5m 4.9ft	kg lb					13510 29780	8650 19070	9630 21230	6350 14000	8220 18120	5460 12040	8.34 (27.4)
0.0m 0.0ft	kg lb					13270 29260	8450 18630	9510 20970	6230 13730	8530 18810	5640 12430	8.10 (26.6)
-1.5m -4.9ft	kg lb			*18180 *40080	12900 28440	13250 29210	8430 18580	9540 21030	6270 13820	9480 20900	6230 13730	7.54 (24.7)
-3.0m -9.8ft	kg lb	*20780 *45810	*20780 *45810	*16060 *35410	13140 28970	*12120 *26720	8610 18980			*10470 *23080	7620 16800	6.59 (21.6)









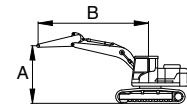

Unit : mm

Model	Boom	Boom	Arm	Counterweight	Shoe	Dozer		Outrigger	
	Type	Length	Length	Weight (kg)	Width	Front	Rear	Front	Rear
HX340S L	Heavy duty	6150	2500	6600	600	-	-	-	-

·  : Rating over-front

·  : Rating over-side or 360 degree



Load point height		Load radius								At max. reach		
		3.0 m (9.8 ft)		4.5 m (14.8 ft)		6.0 m (19.7 ft)		7.5 m (24.6 ft)		Capacity		Reach
												m (ft)
7.5m 24.6ft	kg lb					*9030 *19910	*9030 *19910			*9160 *20190	8800 19400	6.53 (21.4)
6.0m 19.7ft	kg lb					*9380 *20680	*9380 *20680	*9020 *19890	6920 15260	*9030 *19910	6840 15080	7.55 (24.8)
4.5m 14.8ft	kg lb			*13270 *29260	*13270 *29260	*10570 *23300	9600 21160	*9340 *20590	6790 14970	8780 19360	5890 12990	8.17 (26.8)
3.0m 9.8ft	kg lb					*12080 *26630	9080 20020	9870 21760	6560 14460	8140 17950	5430 11970	8.48 (27.8)
1.5m 4.9ft	kg lb					*13360 *29450	8660 19090	9620 21210	6330 13960	7970 17570	5280 11640	8.51 (27.9)
0.0m 0.0ft	kg lb			*19170 *42260	12750 28110	13240 29190	8420 18560	9470 20880	6190 13650	8230 18140	5430 11970	8.27 (27.1)
-1.5m -4.9ft	kg lb	*15260 *33640	*15260 *33640	*18450 *40680	12780 28180	13180 29060	8360 18430	9450 20830	6180 13620	9080 20020	5960 13140	7.72 (25.3)
-3.0m -9.8ft	kg lb	*22130 *48790	*22130 *48790	*16600 *36600	12990 28640	*12550 *27670	8490 18720			*10580 *23320	7190 15850	6.81 (22.3)
-4.5m -14.8ft	kg lb			*12670 *27930	*12670 *27930					*10370 *22860	*10370 *22860	5.31 (17.4)









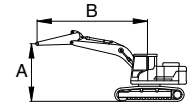

Unit : mm

Model	Boom	Boom	Arm	Counterweight	Shoe	Dozer		Outrigger	
	Type	Length	Length	Weight (kg)	Width	Front	Rear	Front	Rear
HX340S L	Heavy duty	6450	2200	6600	600	-	-	-	-

·  : Rating over-front

·  : Rating over-side or 360 degree



Load point height		Load radius								At max. reach		
		3.0 m (9.8 ft)		4.5 m (14.8 ft)		6.0 m (19.7 ft)		7.5 m (24.6 ft)		Capacity		Reach
												m (ft)
7.5m	kg					*9180	*9180			*9300	8290	6.71
24.6ft	lb					*20240	*20240			*20500	18280	(22.0)
6.0m	kg					*9660	*9660	*9060	6840	*9090	6510	7.71
19.7ft	lb					*21300	*21300	*19970	15080	*20040	14350	(25.3)
4.5m	kg					*10910	9380	*9420	6680	8440	5640	8.32
14.8ft	lb					*24050	20680	*20770	14730	18610	12430	(27.3)
3.0m	kg					*12390	8850	9740	6440	7850	5220	8.62
9.8ft	lb					*27320	19510	21470	14200	17310	11510	(28.3)
1.5m	kg					13290	8460	9500	6220	7700	5090	8.65
4.9ft	lb					29300	18650	20940	13710	16980	11220	(28.4)
0.0m	kg					13070	8260	9360	6100	7960	5240	8.41
0.0ft	lb					28810	18210	20640	13450	17550	11550	(27.6)
-1.5m	kg			*17750	12670	13050	8250	9370	6100	8770	5750	7.88
-4.9ft	lb			*39130	27930	28770	18190	20660	13450	19330	12680	(25.8)
-3.0m	kg	*19890	*19890	*15830	12910	*12210	8410			*9890	6910	6.98
-9.8ft	lb	*43850	*43850	*34900	28460	*26920	18540			*21800	15230	(22.9)
-4.5m	kg			*12030	*12030					*9280	*9280	5.54
-14.8ft	lb			*26520	*26520					*20460	*20460	(18.2)









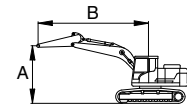

Unit : mm

Model	Boom	Boom	Arm	Counterweight	Shoe	Dozer		Outrigger	
	Type	Length	Length	Weight (kg)	Width	Front	Rear	Front	Rear
HX340S L	Heavy duty	6450	2500	6600	600	-	-	-	-

·  : Rating over-front

·  : Rating over-side or 360 degree



Load point height		Load radius								At max. reach		
		3.0 m (9.8 ft)		4.5 m (14.8 ft)		6.0 m (19.7 ft)		7.5 m (24.6 ft)		Capacity		Reach
												
7.5m 24.6ft	kg lb									*8730 *19250	7950 17530	6.93 (22.7)
6.0m 19.7ft	kg lb					*9230 *20350	*9230 *20350	*8630 *19030	6900 15210	*8620 *19000	6300 13890	7.90 (25.9)
4.5m 14.8ft	kg lb			*13590 *29960	*13590 *29960	*10510 *23170	9450 20830	*9110 *20080	6710 14790	8190 18060	5480 12080	8.49 (27.9)
3.0m 9.8ft	kg lb					*12030 *26520	8900 19620	9750 21500	6450 14220	7620 16800	5060 11160	8.79 (28.8)
1.5m 4.9ft	kg lb					*13260 *29230	8460 18650	9490 20920	6210 13690	7460 16450	4930 10870	8.82 (28.9)
0.0m 0.0ft	kg lb			*17240 *38010	12480 27510	13030 28730	8220 18120	9320 20550	6060 13360	7690 16950	5050 11130	8.58 (28.2)
-1.5m -4.9ft	kg lb			*18050 *39790	12540 27650	12980 28620	8180 18030	9290 20480	6030 13290	8410 18540	5500 12130	8.06 (26.4)
-3.0m -9.8ft	kg lb	*21280 *46910	*21280 *46910	*16340 *36020	12750 28110	*12540 *27650	8300 18300			*9960 *21960	6530 14400	7.19 (23.6)
-4.5m -14.8ft	kg lb			*13020 *28700	*13020 *28700					*9810 *21630	9120 20110	5.80 (19.0)

6. BUCKET SELECTION GUIDE

1) 6000 KG COUNTERWEIGHT



General bucket

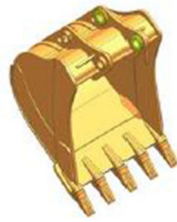

Heavy duty
(without side cutter)



Rock heavy duty

Type	Capacity		Width	Weight	Tooth	MONO						
	SAE Heaped	CECE heaped	Without side cutter			Recommendation						
						6.15 m (20' 2") Boom		6.45 m (21' 2") Boom			6.45 m (21' 2") Boom (HD)	
						2.20 m (7' 3") Arm	2.50 m (8' 2") Arm	2.50 m (8' 2") Arm	3.20 m (10' 6") Arm	4.05 m (13' 3") Arm	2.20 m (7' 3") Arm	2.50 m (8' 2") Arm
m ³ (yd ³)	m ³ (yd ³)	mm (in)	kg (lb)	EA								
General bucket	1.44 (1.88)	1.25 (1.63)	1,380 (54.3")	1,150 (2,540)	5	●	●	●	●	■	●	●
	1.74 (2.28)	1.50 (1.96)	1,620 (63.8")	1,260 (2,780)	6	●	●	◐	■	▲	◐	◐
	2.10 (2.75)	1.80 (2.35)	1,910 (75.2")	1,640 (3,620)	6	■	■	■	▲	X	■	■
Heavy duty	1.44 (1.88)	1.25 (1.63)	1,470 (57.9")	1,520 (3,350)	5	●	●	●	◐	■	●	●
	1.90 (2.49)	1.65 (2.16)	1,600 (63.0")	1,780 (3,920)	5	◐	◐	■	▲	X	■	■
	2.30 (3.01)	2.02 (2.64)	1,750 (68.9")	1,915 (4,220)	5	■	▲	▲	-	-	▲	▲
Rock heavy duty	1.44 (1.88)	1.25 (1.63)	1,470 (57.9")	1,600 (3,530)	5	●	●	●	◐	-	●	●
	1.60 (2.09)	1.39 (1.82)	1,585 (62.4")	1,680 (3,700)	5	●	●	●	■	-	◐	◐
	1.73 (2.26)	1.50 (1.96)	1,710 (67.3")	1,750 (3,860)	5	◐	◐	◐	■	-	◐	◐
	1.83 (2.39)	1.59 (2.08)	1,765 (69.5")	1,850 (4,080)	5	◐	◐	■	▲	-	■	■
	1.90 (2.49)	1.65 (2.16)	1,600 (63.0")	1,980 (4,370)	5	◐	■	■	▲	-	■	■

●	Applicable for materials with density of 2100 kg/m ³ (3500 lb/yd ³) or less
◐	Applicable for materials with density of 1800 kg/m ³ (3000 lb/yd ³) or less
■	Applicable for materials with density of 1500 kg/m ³ (2500 lb/yd ³) or less
▲	Applicable for materials with density of 1200 kg/m ³ (2000 lb/yd ³) or less
X	Not recommended
-	Not available

※ These recommendations are for general conditions and average use.

Work tools and ground conditions have effects on machine performance.

Select an optimum combination according to the working conditions and the type of work that is being done.

Consult with your local Hyundai dealer for information on selecting the correct boom–arm–bucket combination.

2) 6600 KG COUNTERWEIGHT



General bucket



Heavy duty
(without side cutter)



Rock heavy duty

Type	Capacity		Width	Weight	Tooth	MONO						
	SAE Heaped	CECE heaped	Without side cutter			Recommendation						
						6.15 m (20' 2") Boom		6.45 m (21' 2") Boom			6.45 m (21' 2") Boom (HD)	
	m ³ (yd ³)	m ³ (yd ³)	mm (in)			kg (lb)	EA	2.20 m (7' 3") Arm	2.50 m (8' 2") Arm	2.50 m (8' 2") Arm	3.20 m (10' 6") Arm	4.05 m (13' 3") Arm
General bucket	1.44 (1.88)	1.25 (1.63)	1,380 (54.3")	1,150 (2,540)	5	●	●	●	●	◐	●	●
	1.74 (2.28)	1.50 (1.96)	1,620 (63.8")	1,260 (2,780)	6	●	●	●	◐	■	●	●
	2.10 (2.75)	1.80 (2.35)	1,910 (75.2")	1,640 (3,620)	6	◐	◐	■	▲	X	■	■
Heavy duty	1.44 (1.88)	1.25 (1.63)	1,470 (57.9")	1,520 (3,350)	5	●	●	●	●	■	●	●
	1.90 (2.49)	1.65 (2.16)	1,600 (63.0")	1,780 (3,920)	5	◐	◐	◐	■	▲	◐	■
	2.30 (3.01)	2.02 (2.64)	1,750 (68.9")	1,915 (4,220)	5	■	■	▲	-	-	▲	▲
Rock heavy duty	1.44 (1.88)	1.25 (1.63)	1,470 (57.9")	1,600 (3,530)	5	●	●	●	●	-	●	●
	1.60 (2.09)	1.39 (1.82)	1,585 (62.4")	1,680 (3,700)	5	●	●	●	◐	-	●	●
	1.73 (2.26)	1.50 (1.96)	1,710 (67.3")	1,750 (3,860)	5	●	●	◐	■	-	◐	◐
	1.83 (2.39)	1.59 (2.08)	1,765 (69.5")	1,850 (4,080)	5	◐	◐	◐	■	-	◐	◐
	1.90 (2.49)	1.65 (2.16)	1,600 (63.0")	1,980 (4,370)	5	◐	◐	■	▲	-	■	■

- Applicable for materials with density of 2100 kg/m³ (3500 lb/yd³) or less
- ◐ Applicable for materials with density of 1800 kg/m³ (3000 lb/yd³) or less
- Applicable for materials with density of 1500 kg/m³ (2500 lb/yd³) or less
- ▲ Applicable for materials with density of 1200 kg/m³ (2000 lb/yd³) or less
- X Not recommended
- Not available

7. UNDERCARRIAGE

1) TRACKS

X-leg type center frame is integrally welded with reinforced box-section track frames. The design includes dry tracks, lubricated rollers, idlers, sprockets, hydraulic track adjusters with shock absorbing springs and assembled track-type tractor shoes with triple grousers.

2) TYPES OF SHOES

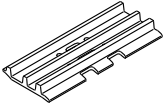
Model	Shapes		Triple grouser		
					
HX340S L	Shoe width	mm (in)	600 (24)	700 (28)	800 (32)
	Operating weight	kg (lb)	33000 (72750)	33570 (74010)	33950 (74850)
	Ground pressure	kgf/cm ² (psi)	0.64 (9.03)	0.55 (7.88)	0.49 (6.97)
	Overall width	mm (ft-in)	3280 (10' 9")	3380 (11' 1")	3480 (11' 5")

3) NUMBER OF ROLLERS AND SHOES ON EACH SIDE

Item	Quantity
Carrier rollers	2EA
Track rollers	9EA
Track shoes	48EA

4) SELECTION OF TRACK SHOE

Suitable track shoes should be selected according to operating conditions.

Method of selecting shoes

Confirm the category from the list of applications in **table 2**, then use **table 1** to select the shoe. Wide shoes (categories B and C) have limitations on applications. Before using wide shoes, check the precautions, then investigate and study the operating conditions to confirm if these shoes are suitable.

Select the narrowest shoe possible to meet the required flotation and ground pressure. Application of wider shoes than recommendations will cause unexpected problem such as bending of shoes, crack of link, breakage of pin, loosening of shoe bolts and the other various problems.

※ **Table 1**

Track shoe	Specification	Category
600 mm triple grouser	Standard	A
700 mm triple grouser	Option	B
800 mm triple grouser	Option	C

※ **Table 2**

Category	Applications	Applications
A	Rocky ground, river beds, normal soil	<ul style="list-style-type: none"> · Travel at low speed on rough ground with large obstacles such as boulders or fallen trees or a wide range of general civil engineering work
B	Normal soil, soft ground	<ul style="list-style-type: none"> · These shoes cannot be used on rough ground with large obstacles such as boulders or fallen trees · Travel at high speed only on flat ground · Travel slowly at low speed if it is impossible to avoid going over obstacles
C	Extremely soft ground (swampy ground)	<ul style="list-style-type: none"> · Use the shoes only in the conditions that the machine sinks and it is impossible to use the shoes of category A or B · These shoes cannot be used on rough ground with large obstacles such as boulders or fallen trees · Travel at high speed only on flat ground · Travel slowly at low speed if it is impossible to avoid going over obstacles

8. SPECIFICATIONS FOR MAJOR COMPONENTS

1) ENGINE

Item	Specification
Model	Hyundai / HM8.3
Type	4-cycle, turbocharged, charger air cooled, mechanical controlled diesel engine
Cooling method	Water cooled
Number of cylinders and arrangement	6 cylinders, in-line
Firing order	1-5-3-6-2-4
Combustion chamber type	Direct injection type
Cylinder bore × stroke	114 × 135 mm (4.49" × 5.31")
Piston displacement	8.3 ℓ (506 cu in)
Compression ratio	18 : 1
Gross power	260 Hp (194 kW) at 2200 rpm
Net power	255 Hp (190 kW) at 2200 rpm
Max. power	261 Hp (195 kW) at 2200 rpm
Maximum torque	1150 N·m (848 lbf·ft) at 1300 rpm
Engine oil quantity	26.5 ℓ (7.0 U.S. gal)
Wet weight	604 kg (1332 lb)
Starting motor	24 V-7.5 kW
Alternator	24 V-90 A

2) MAIN PUMP

Item	Specification
Type	Variable displacement tandem axis piston pumps
Capacity	2 × 175 cc/rev
Rated oil flow	2 × 306 ℓ /min (80.8 U.S. gpm / 67.3 U.K. gpm)
Rated speed	1750 rpm

3) GEAR PUMP

Item	Specification
Type	Fixed displacement gear pump single stage
Capacity	15cc/rev
Maximum pressure	40 kgf/cm ² (570 psi)
Rated oil flow	26.3 ℓ /min (6.9 U.S. gpm/5.8 U.K. gpm)

4) MAIN CONTROL VALVE

Item	Specification
Type	10 spools
Operating method	Hydraulic pilot system
Main relief valve pressure	350 kgf/cm ² (4980 psi) [380 kgf/cm ² (5400 psi)]
Overload relief valve pressure	400 kgf/cm ² (5690 psi)

[]: Power boost

5) SWING MOTOR

Item	Specification
Type	Axial piston motor
Capacity	156.9 cc/rev
Relief pressure	300 kgf/cm ² (4270 psi)
Braking system	Automatic, spring applied hydraulic released
Braking torque	84.4 kgf · m (610 lbf · ft)
Brake release pressure	36.5 kgf/cm ² (519 psi)
Reduction gear type	2 - stage planetary

6) TRAVEL MOTOR

Item	Specification
Type	Variable displacement axial piston motor
Relief pressure	350 kgf/cm ² (4980 psi)
Capacity (max / min)	282.6/156.9 cc/rev
Reduction gear type	2-stage planetary
Braking system	Automatic, spring applied hydraulic released
Brake release pressure	17 kgf/cm ² (242 psi)
Braking torque	134 kgf · m (969 lbf · ft)

7) CYLINDER

Item		Specification
Boom cylinder	Bore dia × Rod dia × Stroke	∅ 150 × ∅ 105 × 1480 mm
	Cushion	Extend only
Arm cylinder	Bore dia × Rod dia × Stroke	∅ 160 × ∅ 110 × 1685 mm ∅ 170 × ∅ 115 × 1685 mm (Heavy duty boom only)
	Cushion	Extend and retract
Bucket cylinder	Bore dia × Rod dia × Stroke	∅ 140 × ∅ 100 × 1285 mm ∅ 145 × ∅ 105 × 1285 mm (2.2 m arm only)
	Cushion	Extend only

※ Discoloration of cylinder rod can occur when the friction reduction additive of lubrication oil spreads on the rod surface.

※ Discoloration does not cause any harmful effect on the cylinder performance.

8) SHOE

Item		Width	Ground pressure	Link quantity	Overall width
HX340S L	Standard	☆ 600 mm (24")	0.64 kgf/cm ² (9.03 psi)	48	3280 mm (10' 9")
	Option	☆ 700 mm (28")	0.55 kgf/cm ² (7.88 psi)	48	3380 mm (11' 1")
		☆ 800 mm (32")	0.49 kgf/cm ² (6.97 psi)	48	3480 mm (11' 5")

☆ : Triple grouser

9. RECOMMENDED OILS

HYUNDAI genuine lubricating oils have been developed to offer the best performance and service life for your equipment. These oils have been tested according to the specifications of HYUNDAI and, therefore, will meet the highest safety and quality requirements.

We recommend that you use only HYUNDAI genuine lubricating oils and grease officially approved by HYUNDAI.

Service point	Kind of fluid	Capacity ℓ (U.S. gal)	Ambient temperature °C (°F)						
			-50 (-58)	-30 (-22)	-20 (-4)	-10 (14)	0 (32)	10 (50)	20 (68)
Engine oil pan	Engine oil★ ¹	26.5 (7.0)	★SAE 0W-40						
			★SAE 0W-30						
			SAE 5W-30						
			SAE 10W-30						
			SAE 15W-40						
Swing drive	Gear oil	11 (2.91)	★SAE 75W-90						
Final drive		7.8×2 (2.1×2)	SAE 80W-90						
Hydraulic tank	Hydraulic oil	Tank : 210 (55.5)	★ISO VG 15						
		System : 414 (109.4)	ISO VG 32						
			ISO VG 46, HBHO VG 46★ ³						
			ISO VG 68						
Fuel tank	Diesel fuel	600 (158.5)	★ASTM D975 NO.1						
			ASTM D975 NO.2						
Fitting (grease nipple)	Grease	As required	★NLGI NO.1						
			NLGI NO.2						
Radiator (reservoir tank)	Mixture of antifreeze and soft water★ ²	27 (7.1)	Ethylene glycol base permanent type (50 : 50)						
			★Ethylene glycol base permanent type (60 : 40)						

SAE : Society of Automotive Engineers

API : American Petroleum Institute

ISO : International Organization for Standardization

NLGI : National Lubricating Grease Institute

ASTM : American Society of Testing and Material

★ : Cold region

Russia, CIS, Mongolia

★¹ : Meet or exceeds API CH-4 grade

★² : Soft water

City water or distilled water

★³ : Hyundai Bio Hydraulic Oil

※ Using any lubricating oils other than HYUNDAI genuine products may lead to a deterioration of performance and cause damage to major components.

※ Do not mix HYUNDAI genuine oil with any other lubricating oil as it may result in damage to the systems of major components.

※ Do not use any engine oil other than that specified above.

※ For HYUNDAI genuine lubricating oils and grease for use in regions with extremely low temperatures, please contact HYUNDAI dealers.