

## SECTION 5 MECHATRONICS SYSTEM

Group 1 Outline .....	5-1
Group 2 Mode Selection System .....	5-3
Group 3 Automatic Deceleration System .....	5-6
Group 4 Power Boost System .....	5-7
Group 5 Travel Speed Control System .....	5-8
Group 6 Automatic Warming Up System .....	5-9
Group 7 Engine Overheat Prevention System .....	5-10
Group 8 Variable Power Control System .....	5-11
Group 9 Attachment Flow Control System .....	5-12
Group 10 Intelligent Power Control System.....	5-13
Group 11 Anti-Restart System .....	5-15
Group 12 Self-Diagnostic System .....	5-16
Group 13 Engine Control System .....	5-40
Group 14 EPPR Valve .....	5-41
Group 15 Monitoring System .....	5-46
Group 16 Fuel Warmer System .....	5-80

# SECTION 5 MECHATRONICS SYSTEM

## GROUP 1 OUTLINE

The ADVANCED CAPO (Computer Aided Power Optimization) system controls engine and pump mutual power at an optimum and less fuel consuming state for the selected work by mode selection, auto-deceleration, power boost function, etc. It monitors machine conditions, for instance, engine speed, coolant temperature, hydraulic oil temperature, and hydraulic oil pressure, etc. It consists of a MCU, a cluster, an accel actuator, EPPR valves, and other components. The MCU and the cluster protect themselves from over-current and high voltage input, and diagnose malfunctions caused by short or open circuit in electric system, and display error codes on the cluster.

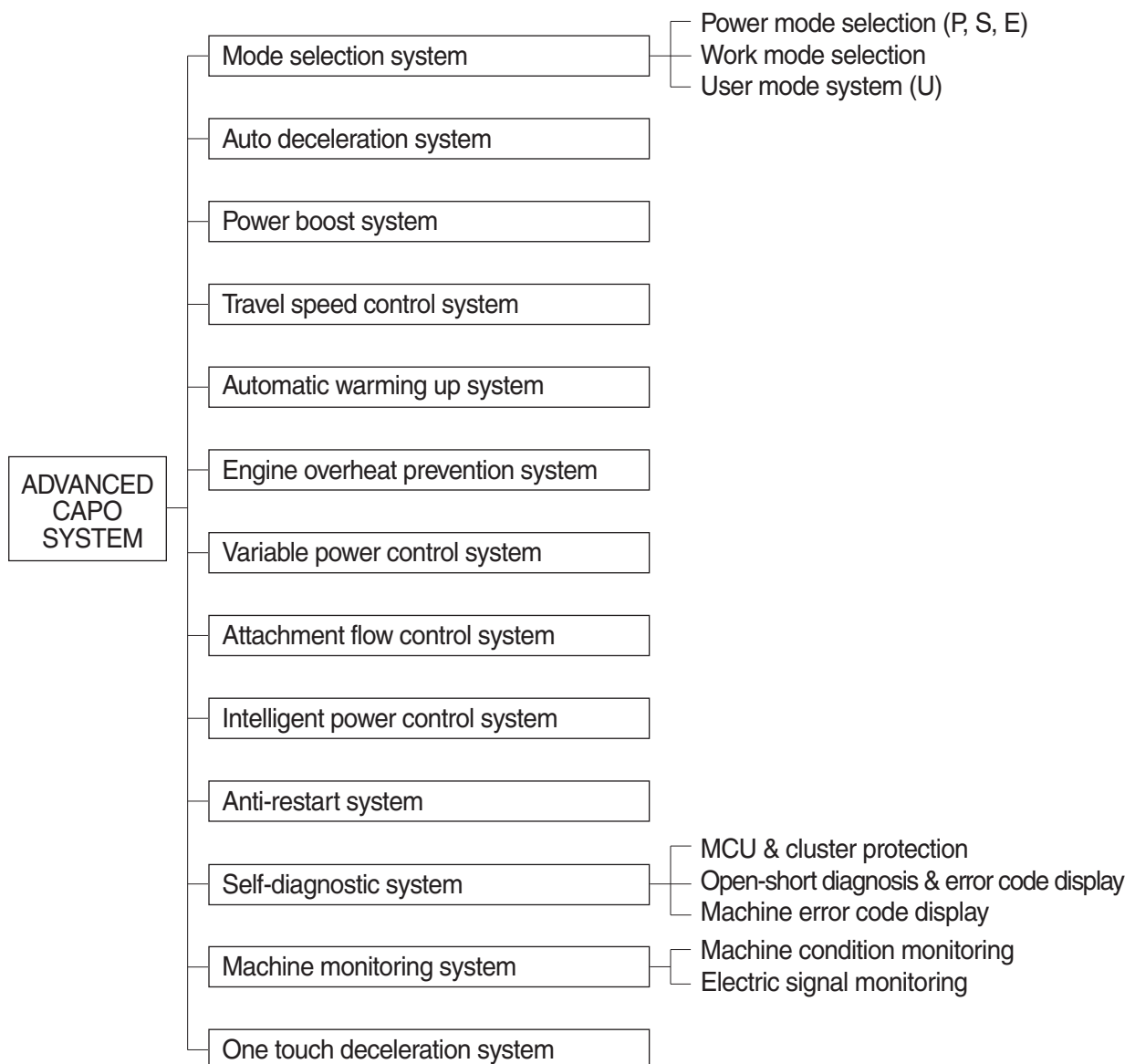

# SYSTEM DIAGRAM

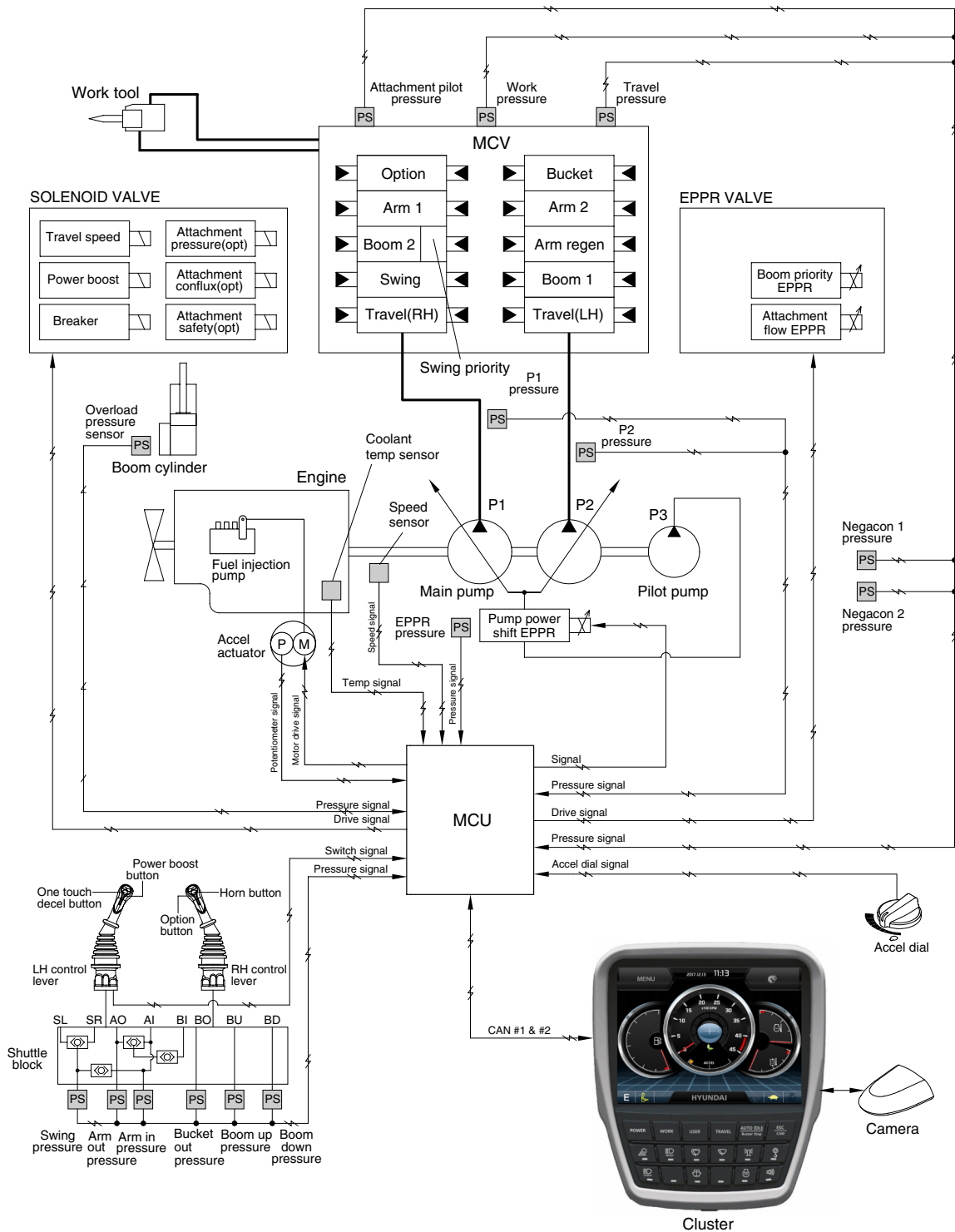

220S5MS01

# GROUP 2 MODE SELECTION SYSTEM

## 1. POWER MODE SELECTION SYSTEM

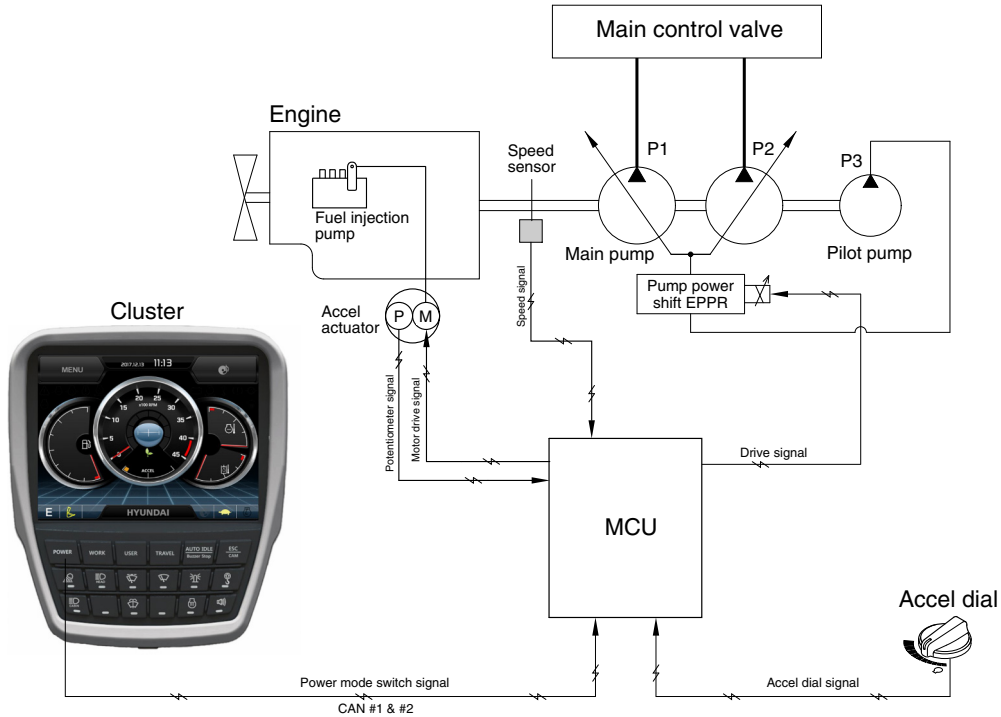

220S5MS02

Mode selection system (micro computer based electro-hydraulic pump and engine mutual control system) optimizes the engine and pump performance.

The combination of 3 power modes (P, S, E) and acceleration mode (10 set) of haptic controller makes it possible to use the engine and pump power more effectively corresponding to the work conditions from a heavy and great power requesting work to a light and precise work.

Power mode	Application	Engine rpm				Power shift by EPPR valve			
		Standard		Option		Standard		Option	
		Unload	Load	Unload	Load	Current (mA)	Pressure (kgf/cm <sup>2</sup> )	Current (mA)	Pressure (kgf/cm <sup>2</sup> )
P	Heavy duty power	1850 ± 50	1850 ± 50	1950 ± 50	1950 ± 50	330 ± 30	10 (~5)	190 ± 30	3 (~3)
S	Standard power	1750 ± 50	1750 ± 50	1850 ± 50	1850 ± 50	360 ± 30	12 (~7) ± 3	250 ± 30	5 (~5) ± 3
E	Economy operation	1650 ± 50	1650 ± 50	1750 ± 50	1750 ± 50	360 ± 30	12 (~7) ± 3	330 ± 30	10 (~5) ± 3
AUTO DECEL	Engine deceleration	1200 ± 100	-	1200 ± 100	-	700 ± 30	38 ± 3	700 ± 30	38 ± 3
One touch decel	Engine quick deceleration	1000 ± 100	-	1000 ± 100	-	700 ± 30	38 ± 3	700 ± 30	38 ± 3
KEY START	Key switch start position	1000 ± 100	-	1000 ± 100	-	700 ± 30	38 ± 3	700 ± 30	38 ± 3

※ Power shift (Standard/Option) can be changed by "Service menu" in "Management" on the cluster.

※ (~\*) : Load



## 2. WORK MODE SELECTION SYSTEM

Work mode consists of the general operation (bucket) and the optional attachment (breaker, crusher).

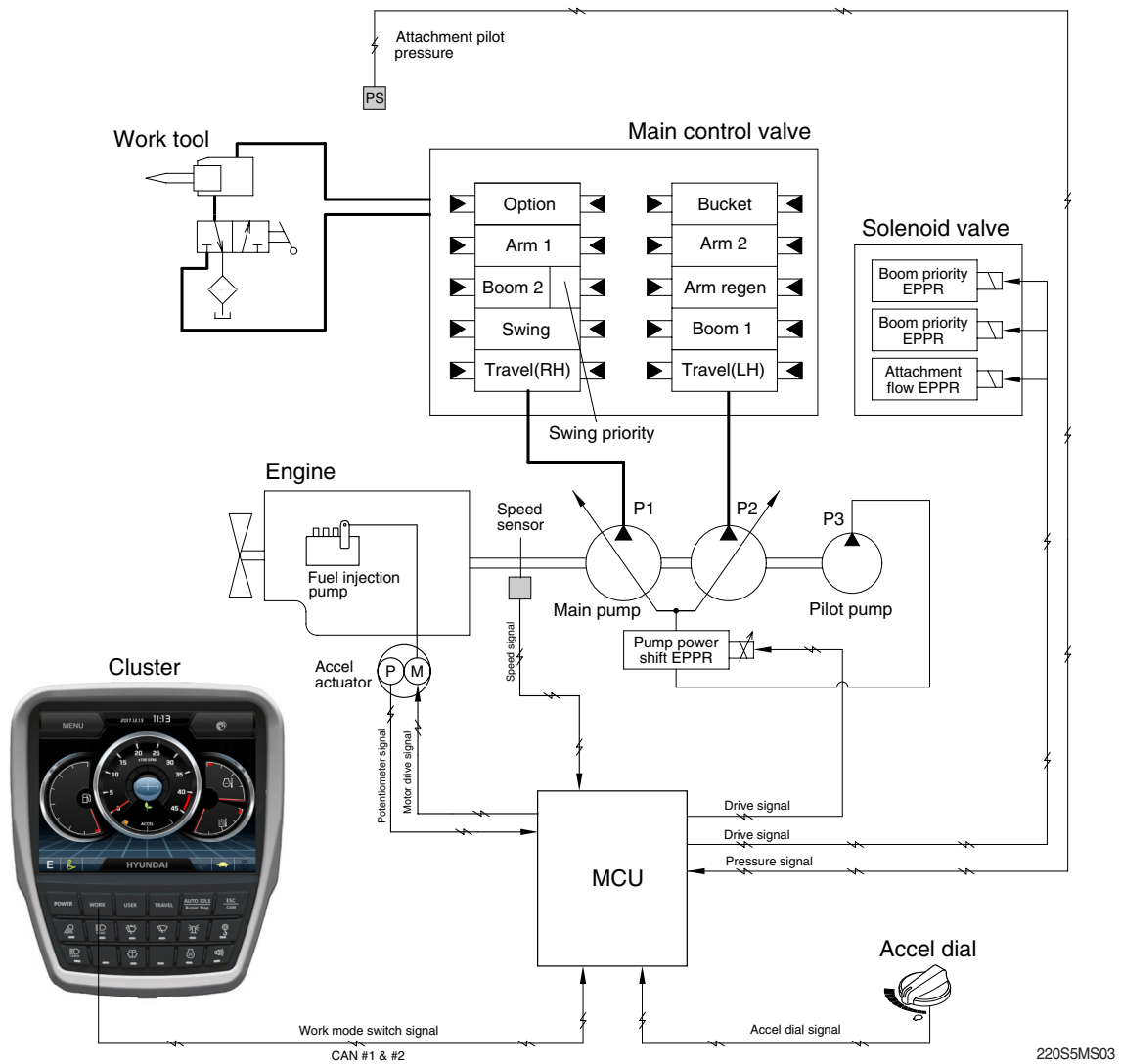

220S5MS03

### 1) GENERAL WORK MODE (bucket)

This mode is used to general digging work.

### 2) ATT WORK MODE (breaker, crusher)

It controls the pump flow and system pressure according to the operation of breaker or crusher.

Description	General mode	Work tool	
	Bucket	Breaker	Crusher
Attachment safety solenoid	OFF	-	ON
Attachment conflux solenoid	OFF	ON/OFF	ON/OFF
Attachment flow EPPR current	100 mA	100~700 mA	100~700 mA
Breaker solenoid*	OFF	ON	-

★ When breaker operating button is pushed.

### 3. USER MODE SELECTION SYSTEM

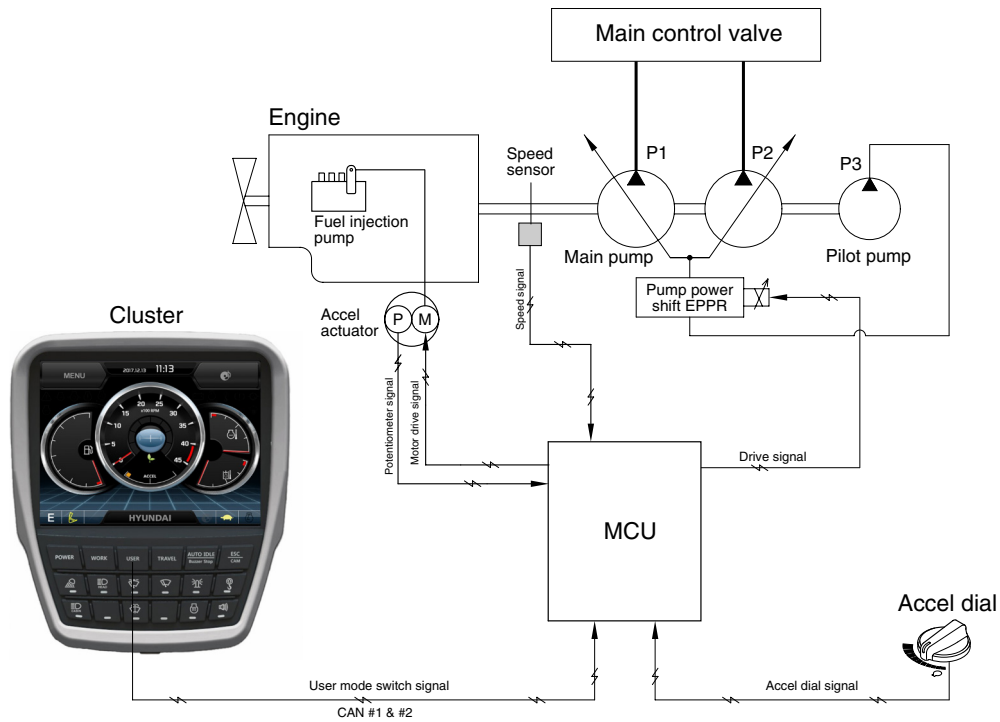

220S5MS04

1) High idle rpm, auto idle rpm and EPPR pressure can be adjusted and memorized in the U-mode.

#### 2) LCD segment vs parameter setting

Step ( )	Engine speed (rpm)	Idle speed (rpm)	Power shift (bar)
1	1400	1000	0
2	1500	1050 (auto idle)	3
3	1550	1100	6
4	1650	1150	9
5	1700	1200	12
6	1750	1250	16
7	1800	1300	20
8	1850	1350	26
9	1900	1400	32
10	1950	1450	38

## GROUP 3 AUTOMATIC DECELERATION SYSTEM

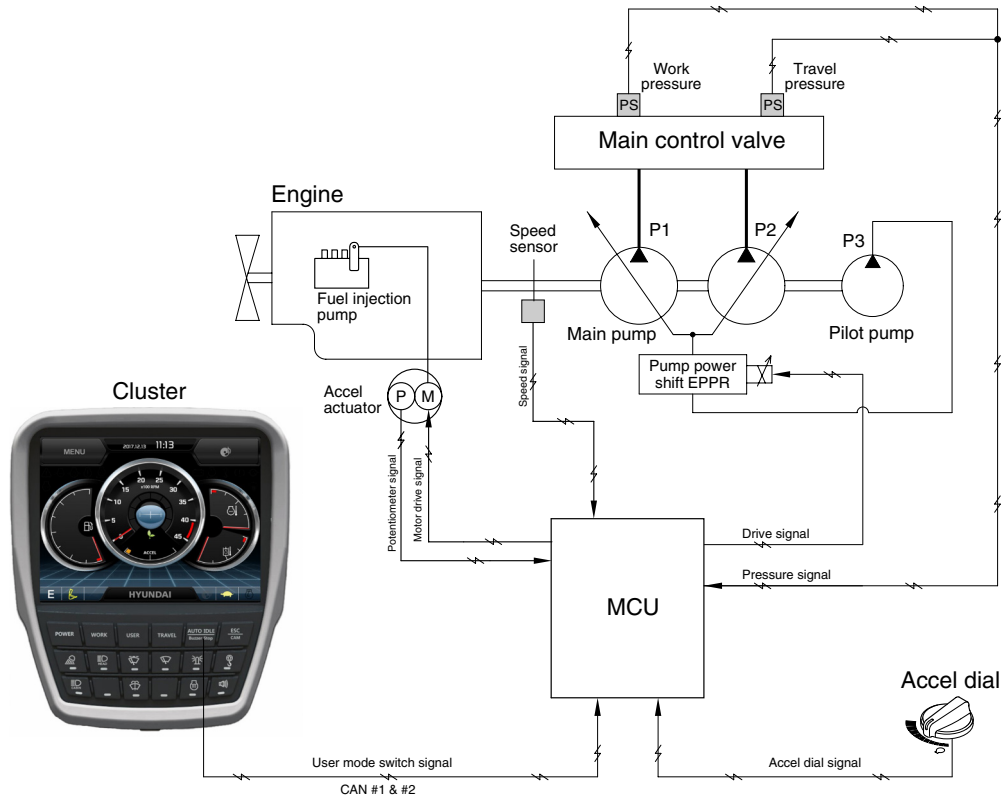

220S5MS05

### 1. WHEN AUTO IDLE PILOT LAMP ON

When all of the work equipment control levers including swing and travel levers are at neutral for 4 seconds, MCU drive the governor moter to reduce the engine speed to 1200 rpm. If the control levers are at neutral for 1 minute, MCU reduces the engine speed to 1000 rpm. As the result of reducing the engine speed, fuel consumption and noise are effectively cut down during non-operation of the control levers.

When the auto idle pilot lamp is turned off by pressing the switch or any control lever is operated, the reduced engine speed rises upto the speed before deceleration in a second.

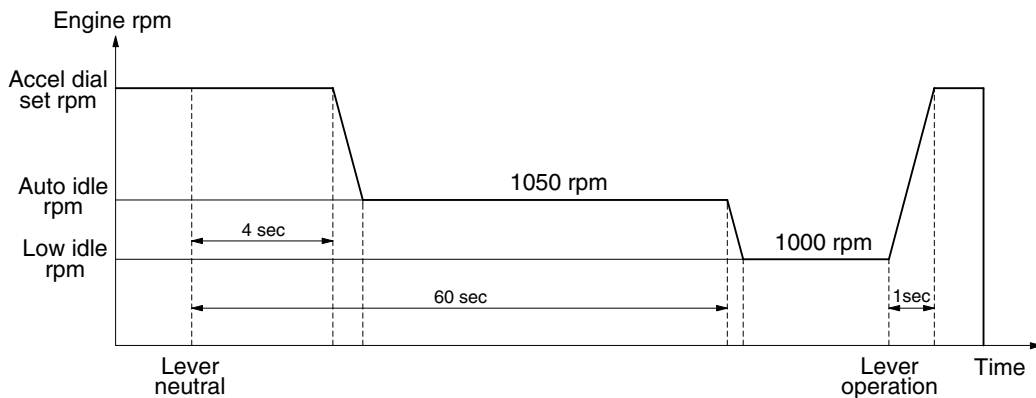

300S5MS56

### 2. WHEN AUTO IDLE PILOT LAMP OFF

The engine speed can be set as desired using the accel dial switch, and even if the control levers are neutral, the engine speed is not reduced.

※ Auto idle function can be activated when accel dial position is over 4.

# GROUP 4 POWER BOOST SYSTEM

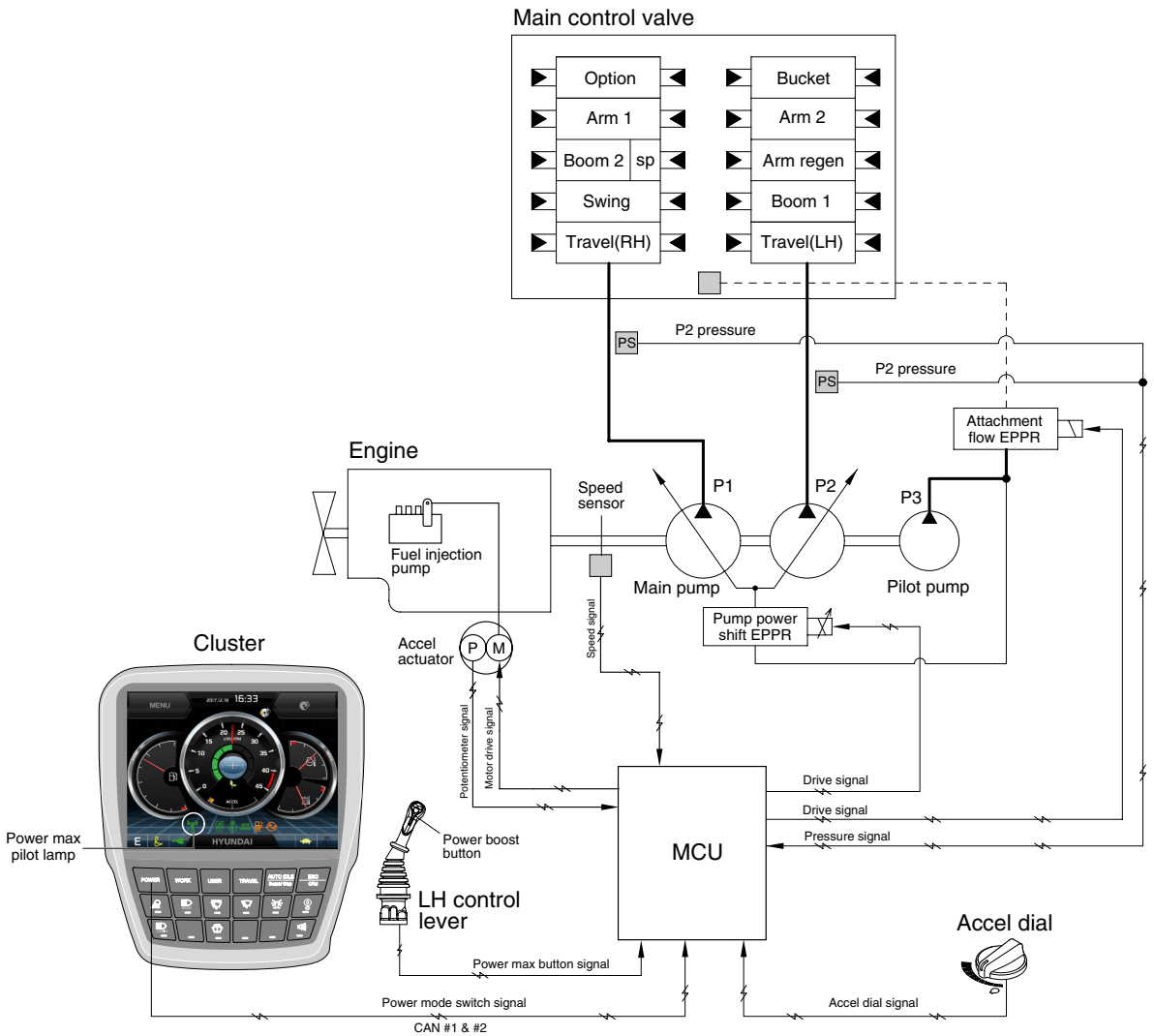

220S5MS06

- When the power boost switch on the left control lever knob is pushed ON, the power mode is set P mode and maximum digging power is increased by 10 %.
- When the power boost function is activated, the power boost solenoid valve pilot pressure raises the set pressure of the main relief valve to increase the digging power.

Description	Condition	Function
Activated	Power boost switch : ON Multimodal dial : over 8	- Power mode : P - Multimodal dial power : 9 - Power boost solenoid : ON - Power boost pilot lmap : ON - Operating time : max 8 seconds
Canceled	Power boost switch : OFF	- Pre-set power mode - Power boost solenoid : OFF - Power boost pilot lamp : OFF

※ When the auto power boost is set to enable and power mode is set to P mode on the cluster, the digging power is automatically increased as working conditions by the MCU. It is operated max 8 seconds.

# GROUP 5 TRAVEL SPEED CONTROL SYSTEM

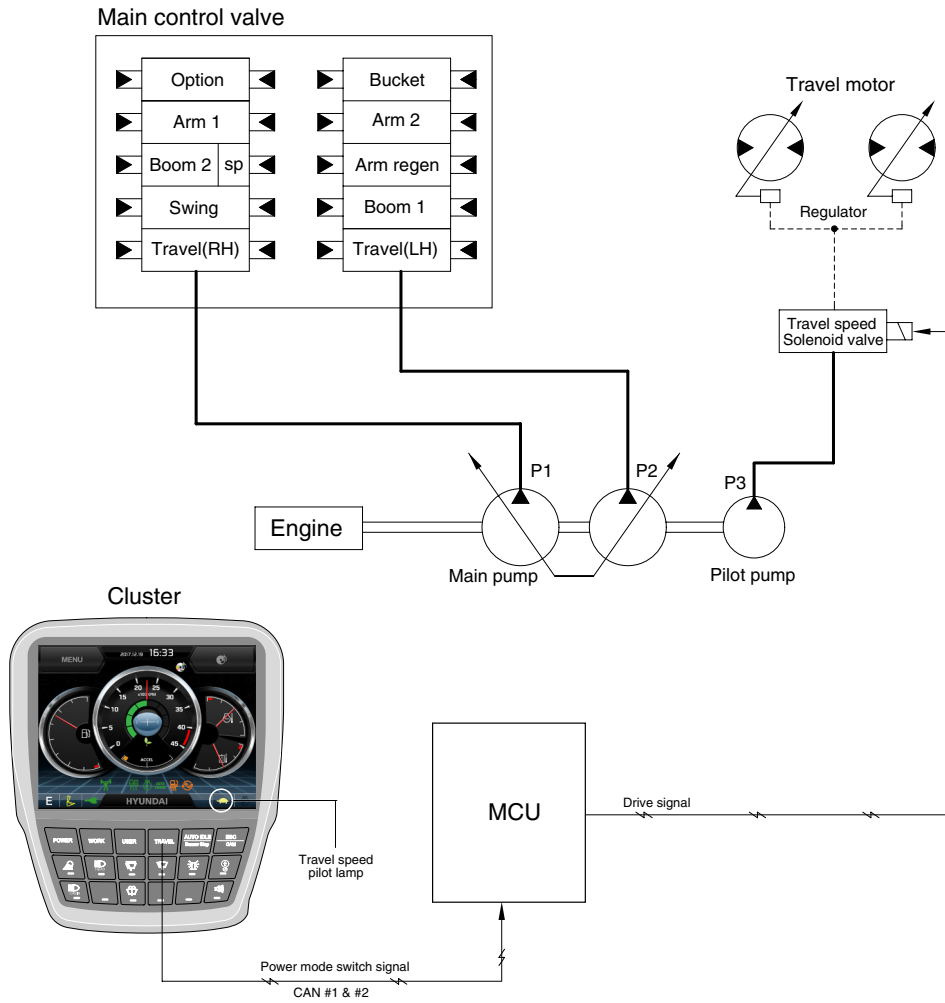

220S5MS10

Travel speed can be switched manually by pressing the travel speed switch on the cluster.

Speed	Travel speed solenoid valve	Lamp on cluster	Operation
Low	OFF	Turtle	Low speed, high driving torque in the travel motor
High	ON	Rabbit	High speed, low driving torque in the travel motor

※ Default : Turtle (Low)

## GROUP 6 AUTOMATIC WARMING UP SYSTEM

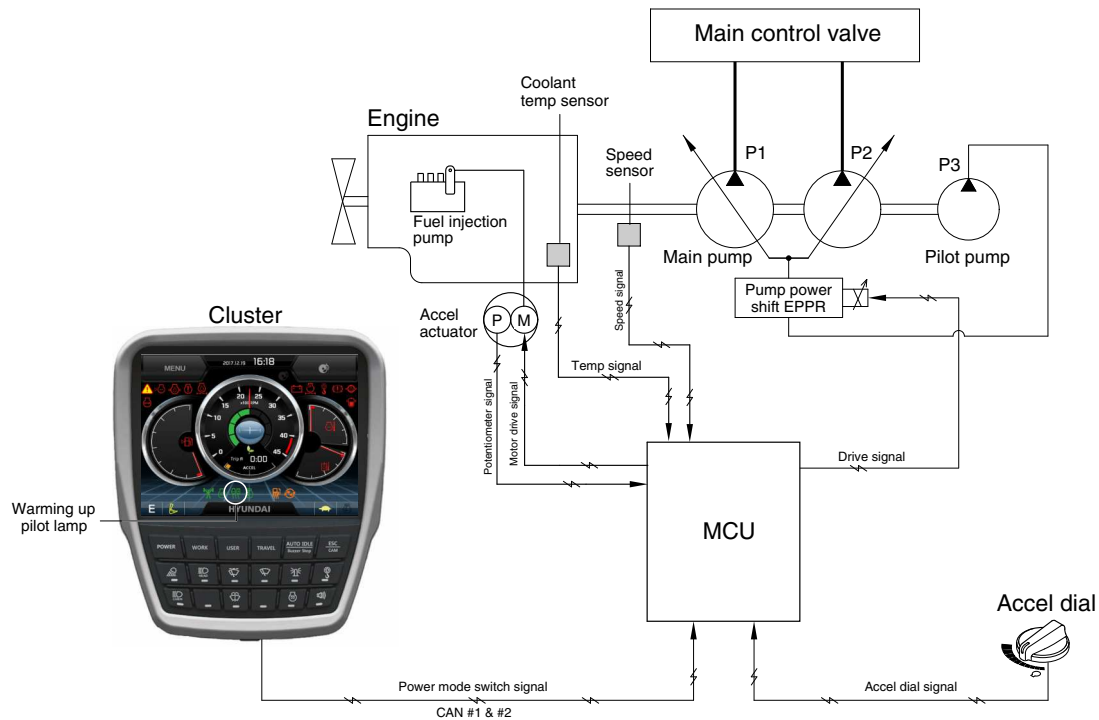

220S5MS07

1. The MCU receives the engine coolant temperature through the temperature sensor, and if the coolant temperature is below 30°C, it increases the engine speed from key start rpm to 1200 rpm. At this time the mode does not change. If the coolant temperature sensor has a fault, the hydraulic oil temperature signal is substituted.
2. In case of the coolant temperature increases up to 30°C, the engine speed is decreased to key start speed. And if an operator changes power mode set during the warming up function, the MCU cancels the automatic warming up function.

### 3. LOGIC TABLE

Description	Condition	Function
Actuated	- Coolant temperature : below 30°C (after engine run)	- Power mode : Default (E mode) - Warming up time : 10 minutes (max) - Warming up pilot lamp : ON
Canceled	- Coolant temperature : Above 30°C - Warming up time : Above 10 minutes - Changed power mode set by operator - RCV lever or pedal operating - Auto idle cancel ※ If any of the above conditions is applicable, the automatic warming up function is canceled	- Power mode : set mode - Warming up pilot lamp : OFF

## GROUP 7 ENGINE OVERHEAT PREVENTION SYSTEM

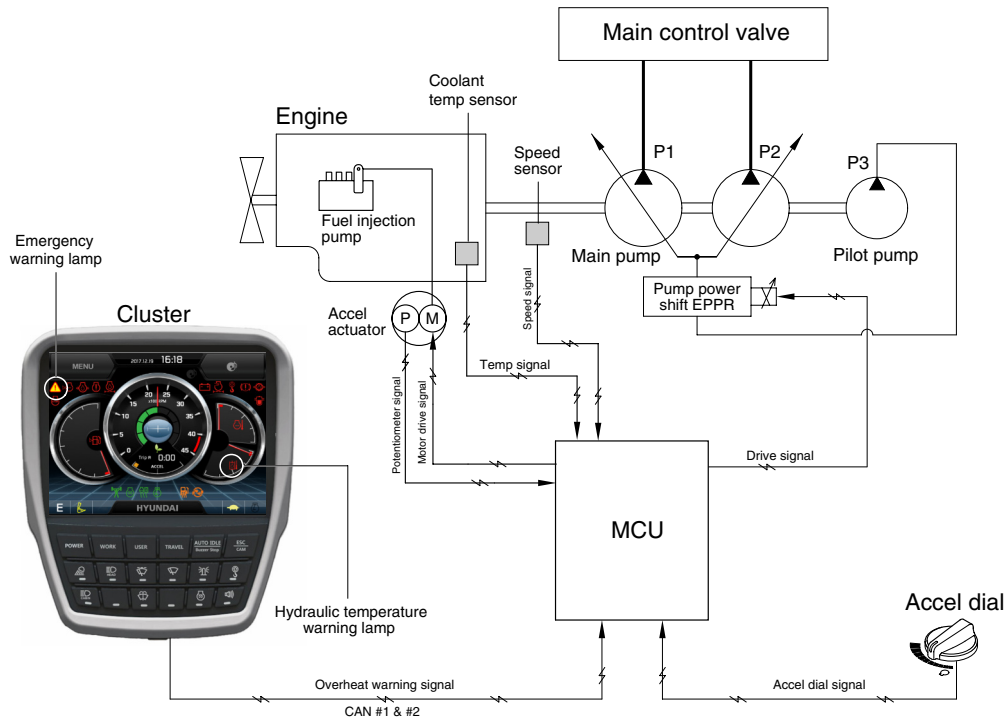

1. If the engine coolant temperature or the hydraulic oil temperature is overheated over 100°C, the warning lamp is ON and the pump input torque or the engine speed is reduced as below logic table.

### 2. LOGIC TABLE

Description		Condition	Function
First step warning	Activated	- Coolant temperature : Above 103°C - Hydraulic oil temperature : Above 100°C	- Warning lamp : ON , buzzer : OFF - Pump input torque is reduced.
	Canceled	- Coolant temperature : Less than 100°C - Hydraulic oil temperature : Less than 95°C	- Warning lamp & buzzer : ON - Pump input torque is reduced.
Second step warning	Activated	- Coolant temperature : Above 107°C - Hydraulic oil temperature : Above 105°C	- Emergency warning lamp pops up on the center of LCD and the buzzer sounds. - Engine speed is reduced after 10 seconds.
	Canceled	- Coolant temperature : Less than 103°C - Hydraulic oil temperature : Less than 100°C	- Return to pre-set the engine speed. - Hold pump absorption torque on the first step warning.

## GROUP 8 VARIABLE POWER CONTROL SYSTEM

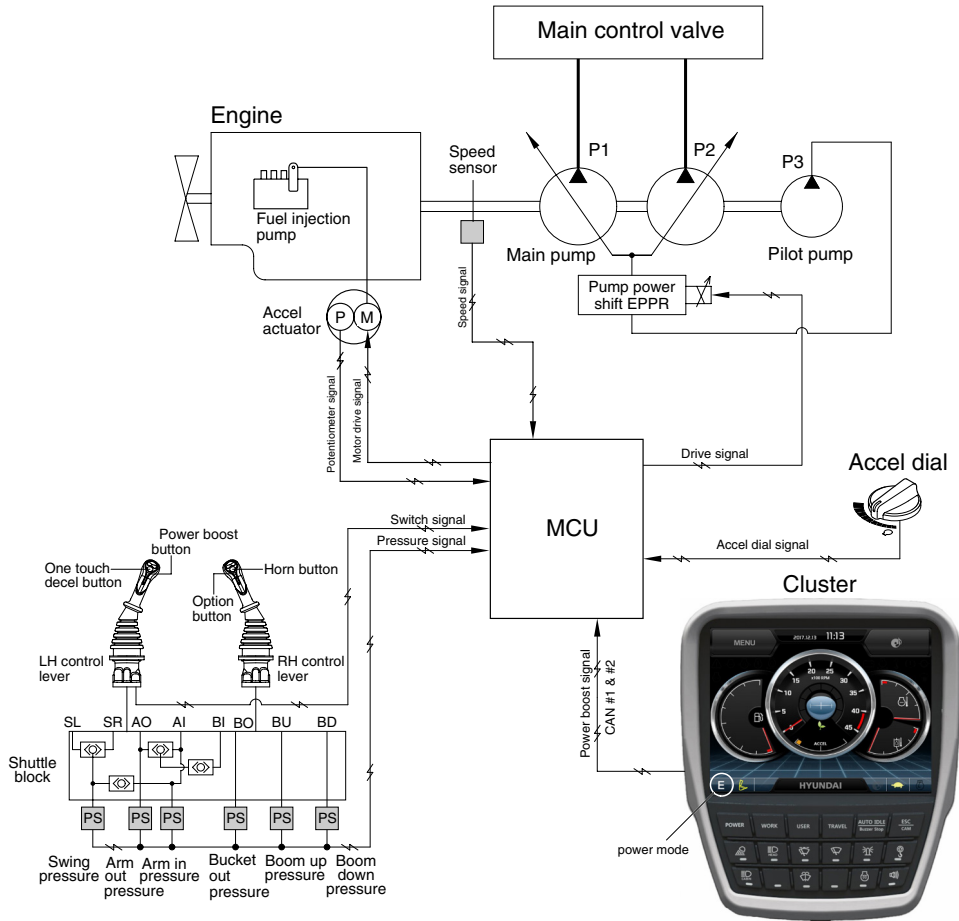

220S5MS09

- The variable power control system controls the engine and pump mutual power according to RCV lever stroke and pump load. It makes fuel saving and smooth control at precise work.

Description	Working condition
Power mode	P, S, E
Work mode	General (bucket)
Pressure sensor	Normal

※ The variable power control function can be activated when the power mode is set to all power mode.



# GROUP 9 ATTACHMENT FLOW CONTROL SYSTEM

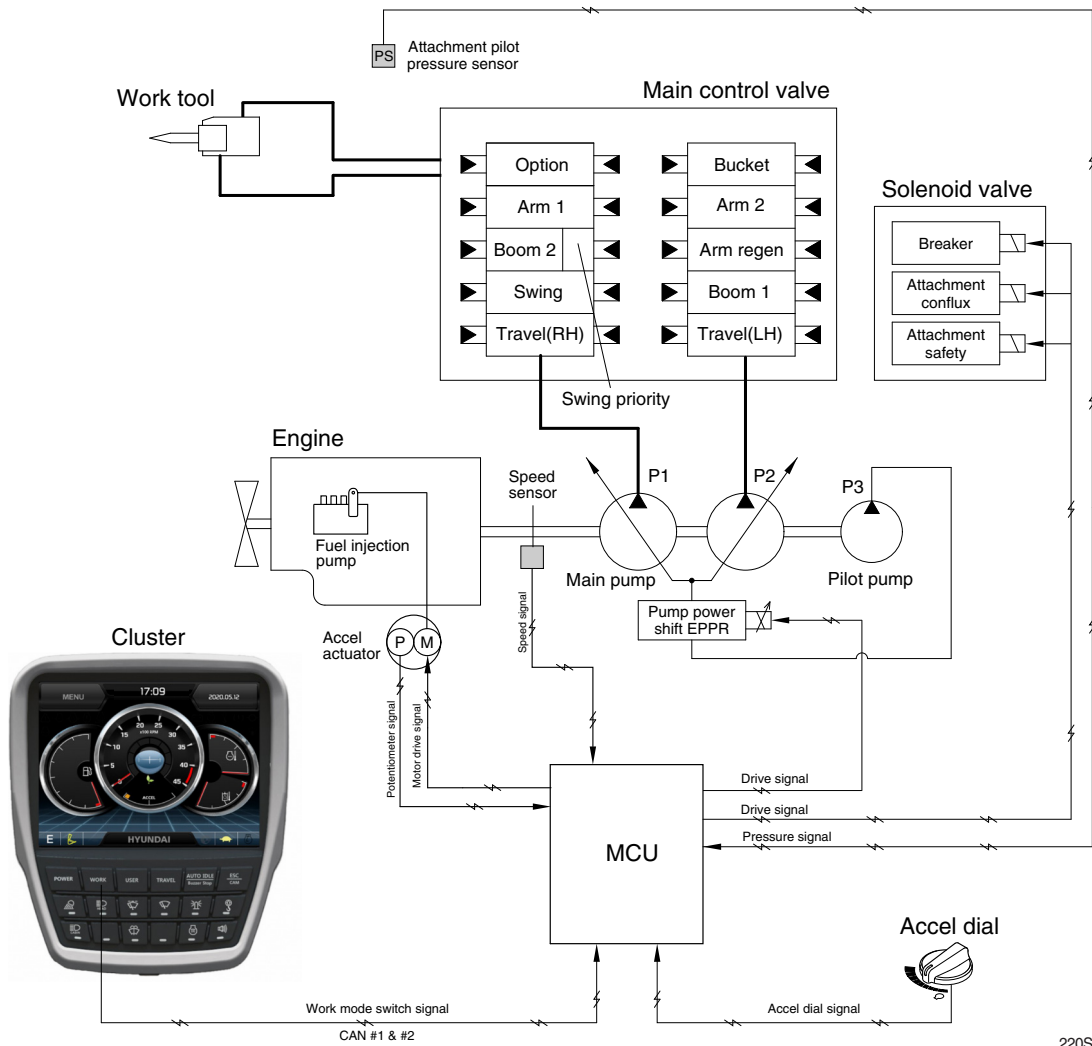

220S5MS11B

- The system is used to control the pump delivery flow according to set of the work tool on the cluster by the attachment flow EPPR valve.

Description	Work tool	
	Breaker	Crusher
Flow level	100 ~ 180 lpm	100 ~ 440 lpm
Attach safety solenoid	-	ON
Attach conflux solenoid	ON/OFF	ON/OFF
Breaker solenoid★	ON	-

※ Refer to the page 5-79 for the attachment kinds and max flow.

★ When breaker operating button is pushed.

# GROUP 10 INTELLIGENT POWER CONTROL SYSTEM

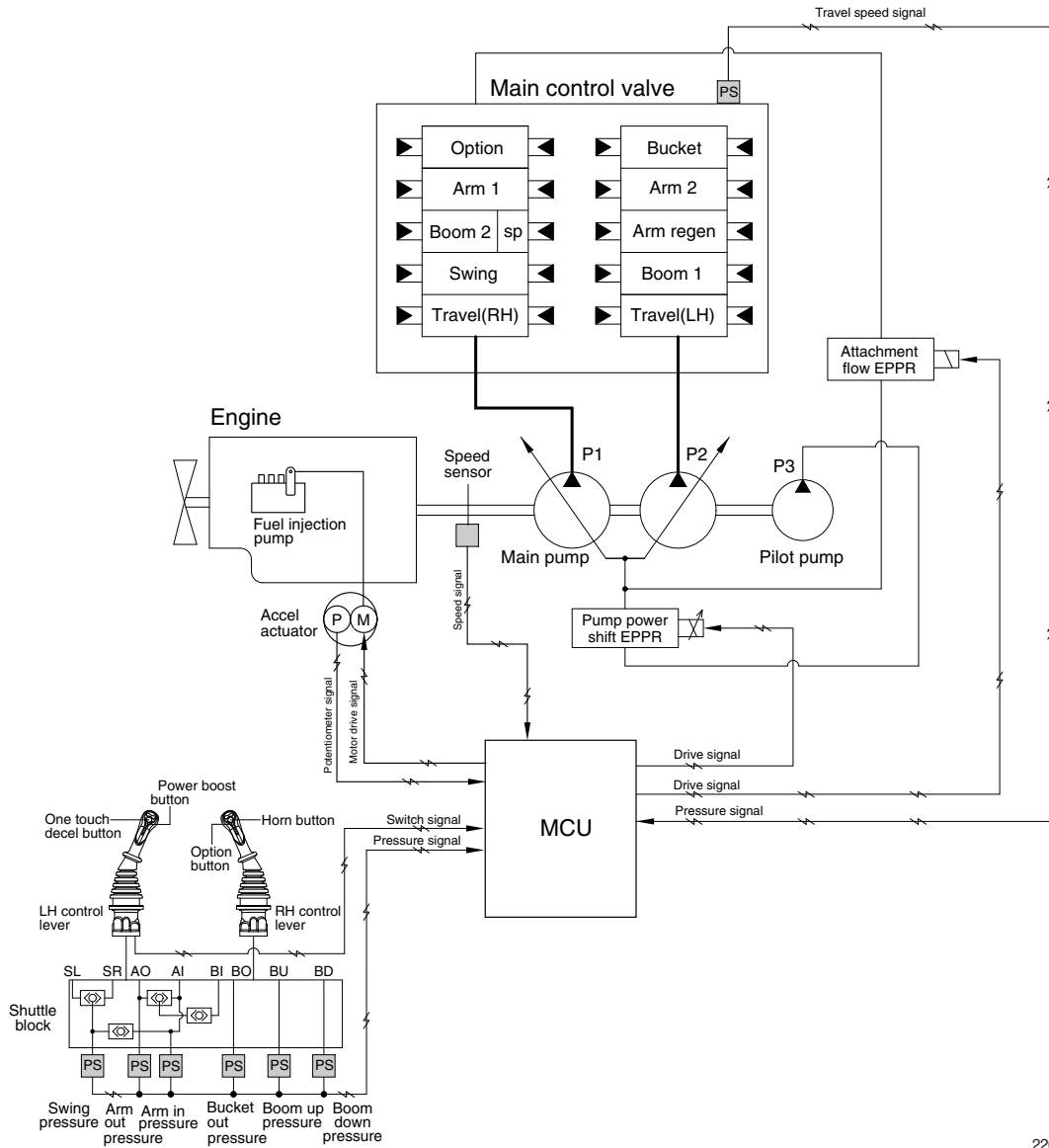

1. When the requirement of pump flow rate is low, IPC mode controls pump flow rate to improve fuel efficiency.

Condition <sup>★1</sup>	Function
IPC mode : ON <sup>★2</sup> Boom up Arm in Not travel motion Not swing motion	Limitation of pump flow rate : Activated
None of upper condition	Limitation of pump flow rate : Canceled

★1 AND condition

★2 IPC mode ON/OFF is selected at "Mode setup > IPC mode". See next page.

## 2. IPC MODE SELECTION

IPC mode ON/OFF and the levels of flow rate limit can be selected at "Mode setup > IPC mode"

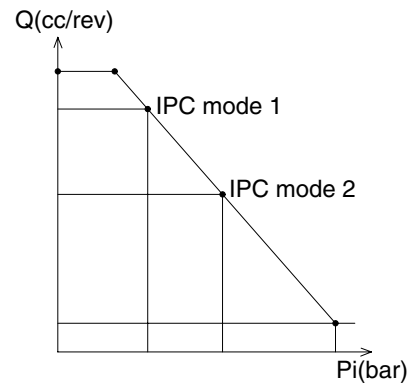

220S5MS19

IPC mode	Description
Balance mode (default)	IPC mode ON, limit level 1
Efficiency mode	IPC mode ON, limit level 2
Speed mode	IPC mode OFF

## GROUP 11 ANTI-RESTART SYSTEM

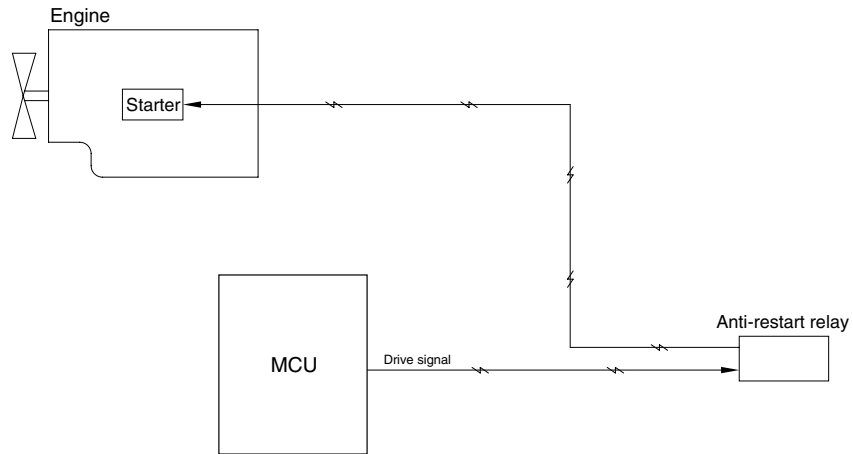

220S5MS18

### 1. ANTI-RESTART FUNCTION

After a few seconds from the engine starts to run, MCU turns off the anti-start relay to protect the starter from inadvertent restarting.

## GROUP 12 SELF-DIAGNOSTIC SYSTEM

### 1. OUTLINE

When any abnormality occurs in the ADVANCED CAPO system caused by electric parts malfunction and by open or short circuit, the MCU diagnoses the problem and sends the error codes to the cluster and also stores them in the memory.

### 2. MONITORING

#### 1) Active fault

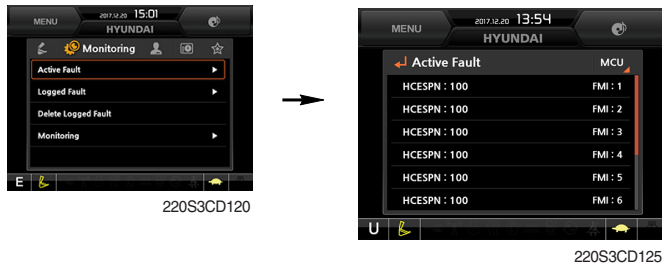

- The active faults of the MCU, can be checked by this menu.

#### 2) Logged fault

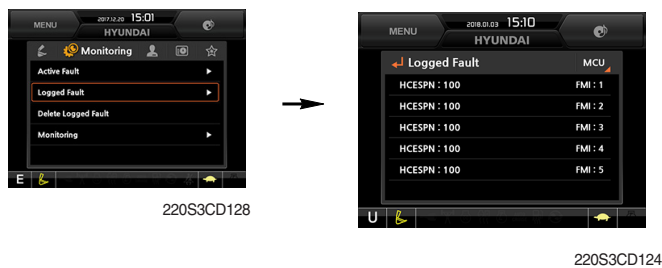

- The logged faults of the MCU, can be checked by this menu.

#### 3) Delete logged fault

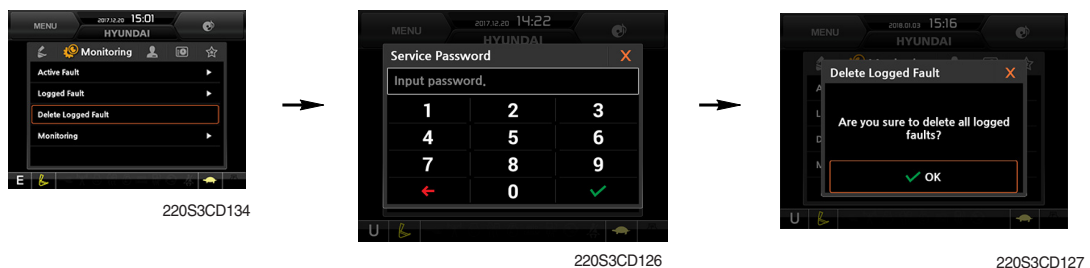

- The logged faults of the MCU, can be deleted by this menu.

### 3. MACHINE ERROR CODES TABLE

DTC		Diagnostic Criteria	Application		
HCESPN	FMI		G	C	W
101	3	10 seconds continuous, Hydraulic Oil Temp. Measurement Voltage > 3.8V	●		
	4	10 seconds continuous, Hydraulic Oil Temp. Measurement Voltage < 0.3V	●		
	(Results / Symptoms) 1. Monitor – Hydraulic oil temperature display failure 2. Control Function – Fan revolutions control failure (Checking list) 1. CD-1 (#2) – CN-52 (#24) Checking Open/Short 2. CD-1 (#1) – CN-51 (#11) Checking Open/Short				
105	0	10 seconds continuous, Working Press. Sensor Measurement Voltage > 5.2V	●		
	1	10 seconds continuous, $0.3V \leq$ Working Press. Sensor Measurement Voltage < 0.8V	●		
	4	10 seconds continuous, Working Press. Sensor Measurement Voltage < 0.3V	●		
	(Results / Symptoms) 1. Monitor – Working Press. display failure 2. Control Function – Auto Idle operation failure, Engine variable horse power control operation failure (Checking list) 1. CD-7 (#B) – CN-52 (#37) Checking Open/Short 2. CD-7 (#A) – CN-51 (#3) Checking Open/Short 3. CD-7 (#C) – CN-51 (#13) Checking Open/Short				
108	0	10 seconds continuous, Travel Oil Press. Sensor Measurement Voltage > 5.2V		●	
	1	10 seconds continuous, $0.3V \leq$ Travel Oil Press. Sensor Measurement Voltage < 0.8V	●		
	4	10 seconds continuous, Travel Oil Press. Sensor Measurement Voltage < 0.3V	●		
	(Results / Symptoms) 1. Monitor – Travel Oil Press. display failure 2. Control Function – Auto Idle operation failure, Engine variable horse power control operation failure, IPC operation failure, Driving alarm operation failure (Checking list) 1. CD-6 (#B) – CN-52 (#38) Checking Open/Short 2. CD-6 (#A) – CN-51 (#3) Checking Open/Short 3. CD-6 (#C) – CN-51 (#13) Checking Open/Short				

※ Some error codes are not applied to this machine.

G : General

C : Crawler Type

W : Wheel Type

DTC		Diagnostic Criteria	Application		
HCESPN	FMI		G	C	W
120	0	10 seconds continuous, Main Pump 1 (P1) Press. Sensor Measurement Voltage > 5.2V	●		
	1	10 seconds continuous, $0.3V \leq$ Main Pump 1 (P1) Press. Sensor Measurement Voltage < 0.8V	●		
	4	10 seconds continuous, Main Pump 1 (P1) Press. Sensor Measurement Voltage < 0.3V	●		
	(Results / Symptoms) 1. Monitor – Main Pump 1 (P1) Press. display failure 2. Control Function – Automatic voltage increase operation failure, Overload at compensation control failure  (Checking list) 1. CD-42 (#B) – CN-52 (#29) Checking Open/Short 2. CD-42 (#A) – CN-51 (#3) Checking Open/Short 3. CD-42 (#C) – CN-51 (#13) Checking Open/Short				
121	0	10 seconds continuous, Main Pump 2 (P2) Press. Sensor Measurement Voltage > 5.2V	●		
	1	10 seconds continuous, $0.3V \leq$ Main Pump 2 (P2) Press. Sensor Measurement Voltage < 0.8V	●		
	4	10 seconds continuous, Main Pump 2 (P2) Press. Sensor Measurement Voltage < 0.3V	●		
	(Results / Symptoms) 1. Monitor – Main Pump 2 (P2) Press. display failure 2. Control Function – Automatic voltage increase operation failure, Overload at compensation control failure  (Checking list) 1. CD-43 (#B) – CN-52 (#30) Checking Open/Short 2. CD-43 (#A) – CN-51 (#3) Checking Open/Short 3. CD-43 (#C) – CN-51 (#13) Checking Open/Short				
122	1	(when you had conditions mounting pressure sensor) 10 seconds continuous, $0.3V \leq$ Overload Press. Sensor Measurement Voltage < 0.8V	●		
	4	(when you had conditions mounting pressure sensor) 10 seconds continuous, Overload Press. Sensor Measurement Voltage < 0.3V	●		
	(Results / Symptoms) 1. Monitor – Overload Press. display failure 2. Control Function – Overload warning alarm failure  (Checking list) 1. CD-31 (#B) – CN-52 (#39) Checking Open/Short 2. CD-31 (#A) – CN-51 (#3) Checking Open/Short 3. CD-31 (#C) – CN-51 (#13) Checking Open/Short				

※ Some error codes are not applied to this machine.

G : General

C : Crawler Type

W : Wheel Type

DTC		Diagnostic Criteria	Application		
HCESPN	FMI		G	C	W
123	0	10 seconds continuous, Negative 1 Press. Sensor Measurement Voltage > 5.2V	●		
	1	10 seconds continuous, 0.3V ≤ Negative 1 Press. Sensor Measurement Voltage < 0.8V	●		
	4	10 seconds continuous, Negative 1 Press. Sensor Measurement Voltage < 0.3V	●		
	(Results / Symptoms) 1. Monitor – Negative 1 Press. display failure 2. Control Function – IPC operation failure, Option attachment flow control operation failure (Checking list) 1. CD-70 (#B) – CN-51 (#39) Checking Open/Short 2. CD-70 (#A) – CN-51 (#3) Checking Open/Short 3. CD-70 (#C) – CN-51 (#13) Checking Open/Short				
124	0	10 seconds continuous, Negative 2 Press. Sensor Measurement Voltage > 5.2V	●		
	1	10 seconds continuous, 0.3V ≤ Negative 2 Press. Sensor Measurement Voltage < 0.8V	●		
	4	10 seconds continuous, Negative 2 Press. Sensor Measurement Voltage < 0.3V	●		
	(Results / Symptoms) 1. Monitor – Negative 2 Press. display failure 2. Control Function – Option attachment flow control operation failure (Checking list) 1. CD-71 (#B) – CN-51 (#40) Checking Open/Short 2. CD-71 (#A) – CN-51 (#3) Checking Open/Short 3. CD-71 (#C) – CN-51 (#13) Checking Open/Short				
127	0	10 seconds continuous, Boom Up Pilot Press. Sensor Measurement Voltage > 5.2V	●		
	1	10 seconds continuous, 0.3V ≤ Boom Up Pilot Press. Sensor Measurement Voltage < 0.8V	●		
	4	10 seconds continuous, Boom Up Pilot Press. Sensor Measurement < 0.3V	●		
	(Results / Symptoms) 1. Monitor – Boom Up Pilot Press. display failure 2. Control Function – Engine/Pump variable horse power control operation failure, IPC operation failure, Boom first operation failure (Checking list) 1. CD-32 (#B) – CN-52 (#35) Checking Open/Short 2. CD-32 (#A) – CN-51 (#3) Checking Open/Short 3. CD-32 (#C) – CN-5 1(#13) Checking Open/Short				

※ Some error codes are not applied to this machine.

G : General

C : Crawler Type

W : Wheel Type



DTC		Diagnostic Criteria	Application		
HCESPN	FMI		G	C	W
128	0	(when you had conditions mounting pressure sensor) 10 seconds continuous, Boom Down Pilot Press. Sensor Measurement Voltage > 5.2V	●		
	1	(when you had conditions mounting pressure sensor) 10 seconds continuous, $0.3V \leq$ Boom Down Pilot Press. Sensor Measurement Voltage < 0.8V	●		
	4	(when you had conditions mounting pressure sensor) 10 seconds continuous, Boom Down Pilot Press. Sensor Measurement Voltage < 0.3V	●		
	(Results / Symptoms) 1. Monitor – Boom Down Pilot Press. display failure 2. Control Function – Boom floating operation failure (Checking list) 1. CD-85 (#B) – CN-52 (#34) Checking Open/Short 2. CD-85 (#A) – CN-51 (#3) Checking Open/Short 3. CD-85 (#C) – CN-51 (#13) Checking Open/Short				
129	0	10 seconds continuous, Arm In Pilot Press. Sensor Measurement Voltage > 4.8V	●		
	1	10 seconds continuous, $0.3V \leq$ Arm In Pilot Press. Sensor Measurement Voltage < 0.8V	●		
	4	10 seconds continuous, Arm In Pilot Press. Sensor Measurement Voltage < 0.3V	●		
	(Results / Symptoms) 1. Monitor – Arm In Pilot Press. display failure 2. Control Function – IPC operation failure (Checking list) 1. CD-90 (#B) – CN-51 (#10) Checking Open/Short 2. CD-90 (#A) – CN-51 (#3) Checking Open/Short 3. CD-90 (#C) – CN-51 (#13) Checking Open/Short				
133	0	10 seconds continuous, Arm In/Out & Bucket In Pilot Press. Sensor Measurement Voltage > 5.2V	●		
	1	10 seconds continuous, $0.3V \leq$ Arm In/Out & Bucket In Pilot Press. Sensor Measurement Voltage < 0.8V	●		
	4	10 seconds continuous, Arm In/Out & Bucket In Pilot Press. Sensor Measurement Voltage < 0.3V	●		
	(Results / Symptoms) 1. Monitor – Arm In/Out & Bucket In Pilot Press. display failure 2. Control Function – Engine variable horse power control operation failure (Checking list) 1. CD-35 (#B) – CN-52 (#28) Checking Open/Short 2. CD-35 (#A) – CN-51 (#3) Checking Open/Short 3. CD-35 (#C) – CN-51 (#13) Checking Open/Short				

※ Some error codes are not applied to this machine.

G : General

C : Crawler Type

W : Wheel Type

DTC		Diagnostic Criteria	Application		
HCESPN	FMI		G	C	W
135	0	10 seconds continuous, Swing Pilot Press. Sensor Measurement Voltage > 5.2V	●		
	1	10 seconds continuous, 0.3V ≤ Swing Pilot Press. Sensor Measurement Voltage < 0.8V	●		
	4	10 seconds continuous, Swing Pilot Press. Sensor Measurement Voltage < 0.3V	●		
	(Results / Symptoms) 1. Monitor – Swing Pilot Press. display failure 2. Control Function – IPC operation, Boom first operation failure (Checking list) 1. CD-24 (#B) – CN-52 (#36) Checking Open/Short 2. CD-24 (#A) – CN-51 (#3) Checking Open/Short 3. CD-24 (#C) – CN-51 (#13) Checking Open/Short				
138	0	Monitor – Select Attachment(breaker / crusher) 10 seconds continuous, Attachment Pilot Press. Sensor Measurement Voltage > 5.2V	●		
	1	Monitor – Select Attachment(breaker / crusher) 10 seconds continuous, 0.3V ≤ Attachment Pilot Press. Sensor Measurement Voltage < 0.8V	●		
	4	Monitor – Select Attachment(breaker / crusher) 10 seconds continuous, Attachment Pilot Press. Sensor Measurement Voltage < 0.3V	●		
	(Results / Symptoms) 1. Monitor – Attachment Pilot Press. display failure 2. Control Function – Option attachment flow control operation failure (Checking list) 1. CD-69 (#B) – CN-52 (#33) Checking Open/Short 2. CD-69 (#A) – CN-51 (#3) Checking Open/Short 3. CD-69 (#C) – CN-51 (#13) Checking Open/Short				
139 (NA)	1	10 seconds continuous, 0.3V ≤ Option Pilot Press. Sensor Measurement Voltage < 0.8V			●
	4	10 seconds continuous, Option Pilot Press. Sensor Measurement Voltage < 0.3V			●
	(Results / Symptoms) 1. Monitor – Option Pilot Press. display failure 2. Control Function – Auto Idle operation failure (Checking list) 1. CD-100 (#B) – CN-52 (#21) Checking Open/Short 2. CD-100 (#A) – CN-51 (#3) Checking Open/Short 3. CD-100 (#C) – CN-1 (#6) Checking Open/Short				

※ Some error codes are not applied to this machine.

G : General

C : Crawler Type

W : Wheel Type

DTC		Diagnostic Criteria	Application		
HCESPN	FMI		G	C	W
140	5	(Detection) (When Pump EPPR Current is more than 10 mA) 10 seconds continuous, Pump EPPR drive current < 0 mA (Cancellation) (When Pump EPPR Current is more than 10 mA) 3 seconds continuous, Pump EPPR drive current ≥10 mA	●		
	6	(Detection) 10 seconds continuous, Pump EPPR drive current > 1.0A (Cancellation) 3 seconds continuous, Pump EPPR drive current ≤ 1.0 A	●		
(Results / Symptoms) 1. Control Function – Pump horse power setting specification difference (Fuel efficiency/speed specification failure) (Checking list) 1. CN-75 (#2) – CN-52 (#9) Checking Open/Short 2. CN-75 (#1) – CN-52 (#19) Checking Open/Short					
141	5	(Model Parameter) mounting Boom Priority EPPR (Detection) (When Boom Priority EPPR Current is more than 10 mA) 10 seconds continuous, Boom Priority EPPR drive current < 0 mA (Cancellation) (When Boom Priority EPPR Current is more than 10 mA) 3 seconds continuous, Boom Priority EPPR drive current ≥ 10 mA	●		
	6	(Detection) 10 seconds continuous, Boom Priority EPPR drive current > 1.0 A (Cancellation) 3 seconds continuous, Boom Priority EPPR drive current ≤ 1.0 A	●		
(Results / Symptoms) 1. Control Function – Boom first control operation failure (Checking list) 1. CN-133 (#2) – CN-52 (#7) Checking Open/Short 2. CN-133 (#1) – CN-52 (#17) Checking Open/Short					

※ Some error codes are not applied to this machine.

G : General

C : Crawler Type

W : Wheel Type

DTC		Diagnostic Criteria	Application		
HCESPN	FMI		G	C	W
143 (NA)	5	(Detection) (When Travel EPPR Current is more than 10 mA) 10 seconds continuous, Travel EPPR drive current = 0 mA (Cancellation) (When Travel EPPR Current is more than 100 mA) 3 seconds continuous, Travel EPPR drive current $\geq$ 10 mA			●
	6	(Detection) 10 seconds continuous, Travel EPPR drive current > 1.0 A (Cancellation) 3 seconds continuous, Travel EPPR drive current $\leq$ 1.0 A			●
	(Results / Symptoms) 1. Control Function – cruise control operation failure (Checking list) 1. CN-246 (#2) – CN-54 (#39) Checking Open/Short 2. CN-246 (#1) – CN-51 (#40) Checking Open/Short				
145 (NA)	5	(Model Parameter) mounting Remote Cooling Fan EPPR (Detection) (When Remote Cooling Fan EPPR Current is more than 10 mA) 10 seconds continuous, Remote Cooling Fan EPPR drive current = 0 mA (Cancellation) (When Remote Cooling Fan EPPR Current is more than 10 mA) 3 seconds continuous, Remote Cooling Fan EPPR drive current $\geq$ 10 mA	●		
	6	(Detection) 10 seconds continuous, Remote Cooling Fan EPPR drive current > 1.0 A (Cancellation) 3 seconds continuous, Remote Cooling Fan EPPR drive current $\leq$ 1.0 A	●		
	(Results / Symptoms) 1. Control Function – Remote fan control operation failure (Checking list) 1. CD-385 (#3) – CN-51 (#9) Checking Open/Short 2. CD-385 (#1) – CN-51 (#14) Checking Open/Short				

※ Some error codes are not applied to this machine.

G : General                      C : Crawler Type                      W : Wheel Type

DTC		Diagnostic Criteria	Application		
HCESPN	FMI		G	C	W
164 (NA)	4	(Detection) (When Working Cutoff Relay is Off) 10 seconds continuous, Working Cutoff Relay drive unit Measurement Voltage $\leq 3.0V$ (Cancellation) (When Working Cutoff Relay is Off) 3 seconds continuous, Working Cutoff Relay drive unit Measurement Voltage $> 3.0V$			●
	6	(Detection) (When Working Cutoff Relay is On) 10 seconds continuous, Working Cutoff Relay drive current $> 6.5 A$ (Cancellation) (When Working Cutoff Relay is On) 3 seconds continuous, Working Cutoff Relay drive current $\leq 6.5 A$			●
(Results / Symptoms) 1. Control Function – (Wheel Excavator) In driving mode, attachment hydraulic pilot pressure cut off failure  (Checking list) 1. CR-47 (#85) – CN-54 (#9) Checking Open/Short 2. CR-47 (#30, #86) – Fuse box (#28) Checking Open/Short					
166	4	(Detection) (When Power Max Solenoid is Off) 10 seconds continuous, Power Max Solenoid drive unit Measurement Voltage $\leq 3.0V$ (Cancellation) (When Power Max Solenoid is Off) 3 seconds continuous, Power Max Solenoid drive unit Measurement Voltage $> 3.0V$	●		
	6	(Detection) (When Power Max Solenoid is On) 5 seconds continuous, Power Max Solenoid drive current $> 4.5 A$ (Cancellation) (When Power Max Solenoid is On) 3 seconds continuous, Power Max Solenoid drive current $\leq 4.5 A$	●		
(Results / Symptoms) 1. Control Function – Voltage increase operation failure (Checking list) 1. CN-88 (#1) – CN-52 (#2) Checking Open/Short 2. CN-88 (#2) – Fuse box (#31) Checking Open/Short					

※ Some error codes are not applied to this machine.

G : General

C : Crawler Type

W : Wheel Type

DTC		Diagnostic Criteria	Application		
HCESPN	FMI		G	C	W
167		(Detection) (When Travel Speed Solenoid is Off) 10 seconds continuous, Travel Speed Solenoid drive unit Measurement Voltage $\leq$ 3.0V (Cancellation) (When Travel Speed Solenoid is Off) 3 seconds continuous, Travel Speed Solenoid drive unit Measurement Voltage $>$ 3.0V		●	
	4	(When Parking mode is not) (Detection) (When Travel Speed Solenoid is Off) 10 seconds continuous, Travel Speed Solenoid drive unit Measurement Voltage $\leq$ 3.0V (Cancellation) (When Travel Speed Solenoid is Off) 3 seconds continuous, Travel Speed Solenoid drive unit Measurement Voltage $>$ 3.0V			●
	6	(Detection) (When Travel Speed Solenoid is On) 10 seconds continuous, Travel Speed Solenoid drive current $>$ 4.5 A (Cancellation) (When Travel Speed Solenoid is On) 3 seconds continuous, Travel Speed Solenoid drive current $\leq$ 4.5 A	●		
	(Results / Symptoms) 1. Control Function – driving in 1/2 transmission operation failure (Checking list) 1. CN-70 (#1) – CN-52 (#3) Checking Open/Short 2. CN-70 (#2) – Fuse box (#31) Checking Open/Short				

※ Some error codes are not applied to this machine.

G : General

C : Crawler Type

W : Wheel Type

DTC		Diagnostic Criteria	Application		
HCESPN	FMI		G	C	W
169	4	Monitor – Selecting attachment(breaker / crusher) (Detection) (When Attachment Conflux Solenoid is Off) 10 seconds continuous, Attachment Conflux Solenoid drive unit Measurement Voltage ≤ 3.0V (Cancellation) (When Attachment Conflux Solenoid is Off) 3 seconds continuous, Attachment Conflux Solenoid drive unit Measurement Voltage > 3.0V	●		
	6	(Detection) (When Attachment Conflux Solenoid is On) 10 seconds continuous, Attachment Conflux Solenoid drive Current > 6.5 A (Cancellation) (When Attachment Conflux Solenoid is On) 3 seconds continuous, Attachment Conflux Solenoid drive Current ≤ 6.5 A	●		
	(Results / symptoms) 1. Control Function – Option attachment flow control – Joining operation failure (Eco breaker mode, crusher mode) (Checking list) 1. CN-237 (#1) – CN-52 (#6) Checking Open/Short 2. CN-237 (#2) – Fuse box (#31) Checking Open/Short				
170 (NA)	4	(Model Parameter) mounting Arm Regenerating Solenoid (Detection) (When Arm Regeneration Solenoid is Off) 10 seconds continuous, Arm Regeneration Solenoid drive unit Measurement Voltage ≤ 3.0V (Cancellation) (When Arm Regeneration Solenoid is Off) 3 seconds continuous, Arm Regeneration Solenoid drive unit Measurement Voltage > 3.0V	●		
	6	(Detection) (When Arm Regeneration Solenoid is On) 10 seconds continuous, Arm Regeneration Solenoid drive current > 4.5 A (Cancellation) (When Arm Regeneration Solenoid is On) 3 seconds continuous, Arm Regeneration Solenoid drive current ≤ 4.5 A	●		
	(Results / symptoms) 1. Control Function – Arm regeneration operation failure (Checking list) 1. CN-135 (#1) – CN-52 (#1) Checking Open/Short 2. CN-135 (#2) – Fuse box (#28) Checking Open/Short				

※ Some error codes are not applied to this machine.

G : General

C : Crawler Type

W : Wheel Type

DTC		Diagnostic Criteria	Application		
HCESPN	FMI		G	C	W
171	4	Monitor – Selecting attachment(crusher) (Detection) (When Attachment Safety Solenoid is Off) 10 seconds continuous, Attachment Safety Solenoid drive unit Measurement Voltage ≤ 3.0V (Cancellation) (When Attachment Safety Solenoid is Off) 3 seconds continuous, Attachment Safety Solenoid drive unit Measurement Voltage > 3.0V	●		
	6	(Detection) (When Attachment Safety Solenoid is On) 10 seconds continuous, Attachment Safety Solenoid drive current > 6.5 A (Cancellation) (When Attachment Safety Solenoid is On) 3 seconds continuous, Attachment Safety Solenoid drive current ≤ 6.5 A	●		
(Results / Symptoms) 1. Control Function – Option attachment flow control – Option spool pilot pressure cut off failure (crusher mode) (Checking list) 1. CN-149 (#1) – CN-52 (#4) Checking Open/Short 2. CN-149 (#2) – Fuse box (#31) Checking Open/Short					
179	4	Monitor – Selecting attachment(breaker / crusher) (Detection) (When Breaker Operating Solenoid is Off) 10 seconds continuous, Attachment Safety Solenoid drive unit Measurement Voltage ≤ 3.0V (Cancellation) (When Breaker Operating Solenoid is Off) 3 seconds continuous, Attachment Safety Solenoid drive unit Measurement Voltage > 3.0V	●		
	6	(Detection) (When Breaker Operating Solenoid is On) 10 seconds continuous, Attachment Safety Solenoid drive current > 6.5 A (Cancellation) (When Breaker Operating Solenoid is On) 3 seconds continuous, Attachment Safety Solenoid drive current ≤ 6.5 A	●		
(Results / Symptoms) 1. Control Function – Option attachment flow control – Breaker operation failure (breaker mode) (Checking list) 1. CN-66 (#1) – CN-15 (#11) Checking Open/Short 2. CN-66 (#2) – CR-62 (#5) Checking Open/Short					

※ Some error codes are not applied to this machine.

G : General

C : Crawler Type

W : Wheel Type



DTC		Diagnostic Criteria	Application		
HCESPN	FMI		G	C	W
181 (NA)	4	(Model Parameter) mounting Reverse Cooling Fan Solenoid (Detection) (When Reverse Cooling Fan Solenoid is Off) 10 seconds continuous, Reverse Cooling Fan Solenoid drive unit Measurement Voltage $\leq$ 3.0V (Cancellation) (When Reverse Cooling Fan Solenoid is Off) 3 seconds continuous, Reverse Cooling Fan Solenoid drive unit Measurement Voltage $>$ 3.0V	●		
	6	(Detection) (When Reverse Cooling Fan Solenoid is On) 10 seconds continuous, Reverse Cooling Fan Solenoid drive current $>$ 4.5 A (Cancellation) (When Reverse Cooling Fan Solenoid is On) 3 seconds continuous, Reverse Cooling Fan Solenoid drive current $\leq$ 4.5 A	●		
(Results / Symptoms) 1. Control Function – Cooling Fan reverse control operation failure (not applicable)					
188	5	(Detection) (When Attachment Flow EPPR 1 current is equal or more than 300 mA) 10 seconds continuous, Attachment Flow EPPR drive current $<$ 100 mA (Cancellation) (When Attachment Flow EPPR 1 current is equal or more than 300 mA) 3 seconds continuous, Attachment Flow EPPR drive current $\geq$ 100 mA	●		
	6	(Detection) 10 seconds continuous, Attachment Flow EPPR 1 drive current $>$ 1.0 A (Cancellation) 3 seconds continuous, Attachment Flow EPPR 1 drive current $\leq$ 1.0 A	●		
(Results / Symptoms) 1. Control Function – IPC operation failure, Option attachment flow control operation failure (Checking list) 1. CN-242 (#2) – CN-52 (#10) Checking Open/Short 2. CN-242 (#1) – CN-52 (#20) Checking Open/Short					

※ Some error codes are not applied to this machine.

G : General

C : Crawler Type

W : Wheel Type

DTC		Diagnostic Criteria	Application		
HCESPN	FMI		G	C	W
189	5	(Detection) (When Attachment Flow EPPR 2 current is equal or more than 300 mA) 10 seconds continuous, Attachment Flow EPPR drive current < 100 mA (Cancellation) (When Attachment Flow EPPR 2 current is equal or more than 300 mA) 3 seconds continuous, Attachment Flow EPPR drive current ≥ 100 mA	●		
	6	(Detection) 10 seconds continuous, Attachment Flow EPPR 2 drive current > 1.0 A (Cancellation) 3 seconds continuous, Attachment Flow EPPR 2 drive current ≤ 1.0 A	●		
(Results / Symptoms) 1. Control Function – Option attachment flow control operation failure (Checking list) 1. CN-242A (#2) – CN-52 (#40) Checking Open/Short 2. CN-242A (#1) – CN-52 (#16) Checking Open/Short					
196 (NA)	0	HW145 10 seconds continuous, Attachment flow control EPPR 1 press. Sensor Measurement Voltage > 5.2V			
	1	HW145 10 seconds continuous, 0.3V ≤ Attachment flow control EPPR 1 press. Sensor Measurement Voltage < 0.8V			
	4	HW145 10 seconds continuous, Attachment flow control EPPR 1 press. Sensor Measurement Voltage < 0.3V			
	(Results / Symptoms) 1. Control Function – Driving second pump joining function operation failure (Checking list) 1. CD-93 (#B) – CN-52 (#34) Checking Open/Short 2. CD-93 (#A) – CN-51 (#32) Checking Open/Short 3. CD-93 (#C) – CN-51 (#31) Checking Open/Short				
200	0	10 seconds continuous, Pump EPPR Press. Sensor Measurement Voltage > 5.2V	●		
	1	10 seconds continuous, 0.3V ≤ Pump EPPR Press. Sensor Measurement Voltage < 0.8V	●		
	4	10 seconds continuous, Pump EPPR Press. Sensor Measurement Voltage < 0.3V	●		
	(Results / Symptoms) 1. Monitor – Pump EPPR Press. display failure 2. Control Function – Pump input horse power control failure, Overload at compensation control operation failure (Fuel efficiency/speed performance failure) (Checking list) 1. CD-44 (#B) – CN-52 (#32) Checking Open/Short 2. CD-44 (#A) – CN-51 (#3) Checking Open/Short 3. CD-44 (#C) – CN-51 (#13) Checking Open/Short				

※ Some error codes are not applied to this machine.

G : General

C : Crawler Type

W : Wheel Type

DTC		Diagnostic Criteria	Application		
HCESPN	FMI		G	C	W
205 (NA)	0	(Mounting pressure sensor) 10 seconds continuous, Boom Cylinder Rod Press. Sensor Measurement Voltage > 5.2V	●		
	1	(Mounting pressure sensor) 10 seconds continuous, 0.3V ≤ Boom Cylinder Rod Press. Sensor Measurement Voltage < 0.8V	●		
	4	(Mounting pressure sensor) 10 seconds continuous, Boom Cylinder Rod Press. Sensor Measurement Voltage < 0.3V	●		
	(Results / Symptoms) 1. Monitor – Boom Cylinder Rod Press. display failure 2. Control Function – Boom floating control operation failure (Checking list) 1. CD-124 (#B) – CN-53 (#5) Checking Open/Short 2. CD-124 (#A) – CN-53 (#3) Checking Open/Short 3. CD-124 (#C) – CN-53 (#13) Checking Open/Short				
218 (NA)	4	Mounting pressure sensor (HCESPN128 or HCESPN 205) (Detection) (When Boom Up Floating Solenoid is Off) 10 seconds continuous, Boom Up Floating Solenoid drive unit Measurement Voltage ≤ 3.0V (Cancellation) (When Boom Up Floating Solenoid is Off) 3 seconds continuous, Boom Up Floating Solenoid drive unit Measurement Voltage > 3.0V	●		
	6	(Detection) (When Boom Up Floating Solenoid is On) 10 seconds continuous, Boom Up Floating Solenoid drive current > 6.5 A (Cancellation) (When Boom Up Floating Solenoid is On) 3 seconds continuous, Boom Up Floating Solenoid drive current ≤ 6.5 A	●		
	(Results / Symptoms) 1. Control Function – Boom floating control operation failure (Checking list) 1. CN-368 (#1) – CN-53 (#20) Checking Open/Short 2. CN-368 (#2) – Fuse box (#17) Checking Open/Short				

※ Some error codes are not applied to this machine.

G : General

C : Crawler Type

W : Wheel Type

DTC		Diagnostic Criteria	Application		
HCESPN	FMI		G	C	W
220 (NA)	4	Mounting pressure sensor (HCESPN 128 or 205) (Detection) (When Boom Down Pilot Pressure Cutoff Solenoid is Off) 10 seconds continuous, Boom Down Pilot Pressure Cutoff Solenoid drive unit Measurement Voltage $\leq 3.0V$ (Cancellation) (When Boom Down Pilot Pressure Cutoff Solenoid is Off) 3 seconds continuous, Boom Down Pilot Pressure Cutoff Solenoid drive unit Measurement Voltage $> 3.0V$	●		
	6	(Detection) (When Boom Down Pilot Pressure Cutoff Solenoid is On) 10 seconds continuous, Boom Down Pilot Pressure Cutoff Solenoid drive current $> 6.5 A$ (Cancellation) (When Boom Down Pilot Pressure Cutoff Solenoid is On) 3 seconds continuous, Boom Down Pilot Pressure Cutoff Solenoid drive current $\leq 6.5 A$	●		
(Results / Symptoms) 1. Control Function – Boom floating control operation failure (Checking list) 1. CN-369 (#1) – CN-53 (#35) Checking Open/Short 2. CN-369 (#2) – Fuse box (#17) Checking Open/Short					
221 (NA)	5	Monitor – Selecting attachment(breaker / crusher) (Detection) (When ATT Relief Setting EPPR 1 Current is equal or more than 10 mA) 10 seconds continuous, ATT Relief Setting EPPR 1 drive current = 0 mA (Cancellation) ATT Relief Setting EPPR 1 Current is equal or more than 10 mA) 3 seconds continuous, ATT Relief Setting EPPR 1 drive current $\geq 10 mA$	●		
	6	(Detection) 10 seconds continuous, ATT Relief Setting EPPR 1 drive current $> 1.0 A$ (Cancellation) 3 seconds continuous, ATT Relief Setting EPPR 1 drive current $\leq 1.0 A$	●		
(Results / Symptoms) 1. Control Function – Option attachment flow control – P1 relief pressure setting failure (Checking list) 1. CN-365 (#2) – CN-53 (#39) Checking Open/Short 2. CN-365 (#1) – CN-53 (#40) Checking Open/Short					

※ Some error codes are not applied to this machine.

G : General

C : Crawler Type

W : Wheel Type

DTC		Diagnostic Criteria	Application		
HCESPN	FMI		G	C	W
222 (NA)	5	Monitor – Selecting attachment(crusher) (Detection) (When ATT Relief Setting EPPR 2 Current is equal or more than 10 mA) 10 seconds continuous, ATT Relief Setting EPPR 2 drive current = 0 mA (Cancellation) (When ATT Relief Setting EPPR 2 Current is equal or more than 10 mA) 3 seconds continuous, ATT Relief Setting EPPR 2 drive current ≥ 10mA	●		
	6	(Detection) 10 seconds continuous, ATT Relief Setting EPPR 2 drive current > 1.0 A (Cancellation) 3 seconds continuous, ATT Relief Setting EPPR 2 drive current ≤ 1.0 A	●		
(Results / Symptoms) 1. Control Function – Option attachment flow control – P2 relief pressure setting failure (Checking list) 1. CN-366 (#2) – CN-53 (#32) Checking Open/Short 2. CN-366 (#1) – CN-53 (#33) Checking Open/Short					
301	3	10 seconds continuous, Fuel Level Measurement Voltage > 3.8V	●		
	4	10 seconds continuous, Fuel Level Measurement Voltage < 0.3V	●		
	(Results / Symptoms) 1. Monitor – Fuel remaining display failure (Checking list) 1. CD-2 (#2) – CN-52 (#26) Checking Open/Short 2. CD-2 (#1) – CN-51 (#11) Checking Open/Short				
325	4	(Model Parameter) mounting Fuel Heater Relay (Detection) (When Fuel Heater Relay is Off) 10 seconds continuous, Fuel Heater Relay drive unit Measurement Voltage ≤ 3.0V (Cancellation) (When Fuel Heater Relay is Off) 3 seconds continuous, Fuel Heater Relay drive unit Measurement Voltage > 3.0V	●		
	6	(Detection) (When Fuel Heater Relay is On) 10 seconds continuous, Fuel Heater Relay drive current > 4.5 A (Cancellation) (When Fuel Heater Relay is On) 3 seconds continuous, Fuel Heater Relay drive current ≤ 4.5 A	●		
(Results / Symptoms) 1. Control Function – Fuel heater operation failure (Checking list) 1. CR-46 (#85) – CN-52 (#12) Checking Open/Short 2. CR-46 (#86) – Fuse box (#22) Checking Open/Short					

※ Some error codes are not applied to this machine.

G : General

C : Crawler Type

W : Wheel Type

DTC		Diagnostic Criteria	Application		
HCESPN	FMI		G	C	W
501 (NA)	0	10 seconds continuous, Transmission Oil Press. Sensor Measurement Voltage > 5.2V			●
	1	10 seconds continuous, 0.3V ≤ Transmission Oil Press. Sensor Measurement Voltage < 0.8V			●
	4	10 seconds continuous, Transmission Oil Press. Sensor Measurement Voltage < 0.3V			●
	(Results / Symptoms) 1. Monitor – Transmission Oil Press. display failure, Transmission Oil low pressure warning failure (Checking list) 1. CD-5 (#B) – CN-54 (#27) Checking Open/Short 2. CD-5 (#A) – CN-54 (#3) Checking Open/Short 3. CD-5 (#C) – CN-54 (#13) Checking Open/Short				
503 (NA)	0	10 seconds continuous, Brake Oil Press. Sensor Measurement Voltage > 5.2V			●
	1	10 seconds continuous, 0.3V ≤ Brake Oil Press. Sensor Measurement Voltage < 0.8V			●
	4	10 seconds continuous, Brake Oil Press. Sensor Measurement Voltage < 0.3V			●
	(Results / Symptoms) 1. Monitor – Brake Oil Press. display failure, Brake Oil low pressure warning failure (Checking list) 1. CD-3 (#B) – CN-54 (#4) Checking Open/Short 2. CD-3 (#A) – CN-54 (#3) Checking Open/Short 3. CD-3 (#C) – CN-54 (#13) Checking Open/Short				
505 (NA)	0	10 seconds continuous, Working Brake Press. Sensor Measurement Voltage > 5.2V			●
	1	10 seconds continuous, 0.3V ≤ Working Brake Press. Sensor Measurement Voltage < 0.8V			●
	4	10 seconds continuous, Working Brake Press. Sensor Measurement Voltage < 0.3V			●
	(Results / Symptoms) 1. Monitor – Working Brake Oil Press. display failure, Working Brake Oil low pressure warning failure (Checking list) 1. CD-38 (#B) – CN-54 (#5) Checking Open/Short 2. CD-38 (#A) – CN-54 (#3) Checking Open/Short 3. CD-38 (#C) – CN-54 (#13) Checking Open/Short				

※ Some error codes are not applied to this machine.

G : General

C : Crawler Type

W : Wheel Type

DTC		Diagnostic Criteria	Application		
HCESPN	FMI		G	C	W
514 (NA)	4	(Detection) (When Parking Relay is Off) 10 seconds continuous, Parking Relay drive unit Measurement Voltage $\leq 3.0V$ (Cancellation) (When Parking Relay is Off) 3 seconds continuous, Parking Relay drive unit Measurement Voltage $> 3.0V$			●
	6	(Detection) (When Parking Relay is On) 10 seconds continuous, Parking Relay drive current $> 6.5 A$ (Cancellation) (When Parking Relay is On) 3 seconds continuous, Parking Relay drive current $\leq 6.5 A$			●
(Results / Symptoms) 1. Control Function – Parking Relay operation failure (Checking list) 1. CR-66 (#1) – CN-54 (#20) Checking Open/Short 2. CR-66 (#2) – Fuse box (#30) Checking Open/Short					
517 (NA)	4	(Detection) (When Traveling Cutoff Relay is Off) 10 seconds continuous, Traveling Cutoff Relay drive unit Measurement Voltage $\leq 3.0V$ (Cancellation) (When Traveling Cutoff Relay is Off) 3 seconds continuous, Traveling Cutoff Relay drive unit Measurement Voltage $> 3.0V$			●
	6	(Detection) (When Traveling Cutoff Relay is On) 10 seconds continuous, Traveling Cutoff Relay drive current $> 6.5 A$ (Cancellation) (When Traveling Cutoff Relay is On) 3 seconds continuous, Traveling Cutoff Relay drive current $\leq 6.5 A$			●
(Results / Symptoms) 1. Control Function – Traveling Cutoff Relay operation failure (Checking list) 1. CR-47 (#85) – CN-54 (#9) Checking Open/Short 2. CR-47 (#86) – Fuse box (#28) Checking Open/Short					

※ Some error codes are not applied to this machine.

G : General

C : Crawler Type

W : Wheel Type

DTC		Diagnostic Criteria	Application		
HCESPN	FMI		G	C	W
525 (NA)	4	(Detection) (When Ram Lock Solenoid is Off) 10 seconds continuous, Ram Lock Solenoid drive unit Measurement Voltage $\leq 3.0V$ (Cancellation) (When Ram Lock Solenoid is Off) 3 seconds continuous, Ram Lock Solenoid drive unit Measurement Voltage $> 3.0V$			●
	6	(Detection) (When Ram Lock Solenoid is On) 10 seconds continuous, Ram Lock Solenoid drive current $> 6.5 A$ (Cancellation) (When Ram Lock Solenoid is On) 3 seconds continuous, Ram Lock Solenoid drive current $\leq 6.5 A$			●
(Results / Symptoms) 1. Control Function – Ram lock control operation failure (Checking list) 1. CN-69 (#1) – CN-54 (#8) Checking Open/Short 2. CN-69 (#2) – Fuse box (#33) Checking Open/Short					
527 (NA)	4	(Detection) (When Creep Solenoid is Off) 10 seconds continuous, Creep Solenoid drive unit Measurement Voltage $\leq 3.0V$ (Cancellation) (When Creep Solenoid is Off) 3 seconds continuous, Creep Solenoid drive unit Measurement Voltage $> 3.0V$			●
	6	(Detection) (When Creep Solenoid is On) 10 seconds continuous, Creep Solenoid drive current $> 6.5 A$ (Cancellation) (When Creep Solenoid is On) 3 seconds continuous, Creep Solenoid drive current $\leq 6.5 A$			●
(Results / Symptoms) 1. Control Function – Creep mode operation failure (Checking list) 1. CN-206 (#1) – CN-54 (#7) Checking Open/Short 2. CN-206 (#2) – Fuse box (#30) Checking Open/Short					

※ Some error codes are not applied to this machine.

G : General

C : Crawler Type

W : Wheel Type



DTC		Diagnostic Criteria	Application		
HCESPN	FMI		G	C	W
530 (NA)	0	10 seconds continuous, Travel Forward Press. Sensor Measurement Voltage > 5.2V			●
	1	10 seconds continuous, 0.3V ≤ Travel Forward Press. Sensor Measurement Voltage < 0.8V			●
	4	10 seconds continuous, Travel Forward Press. Sensor Measurement Voltage < 0.3V			●
	(Results / Symptoms) 1. Monitor – Travel Forward Press. display failure 2. Control Function – Driving interoperability power control operation failure (Checking list) 1. CD-73 (#B) – CN-54 (#6) Checking Open/Short 2. CD-73 (#A) – CN-54 (#3) Checking Open/Short 3. CD-73 (#C) – CN-54 (#13) Checking Open/Short				
531 (NA)	1	10 seconds continuous, 0.3V ≤ Travel Reverse Press. Sensor Measurement Voltage < 0.8V			●
	4	10 seconds continuous, Travel Reverse Press. Sensor Measurement Voltage < 0.3V			●
	(Results / Symptoms) 1. Monitor – Travel Reverse Press. display failure 2. Control Function – Driving interoperability power control operation failure (Checking list) 1. CD-74 (#B) – CN-54 (#23) Checking Open/Short 2. CD-74 (#A) – CN-54 (#3) Checking Open/Short 3. CD-74 (#C) – CN-54 (#13) Checking Open/Short				
705	0	10 seconds continuous, Battery input Voltage > 35V	●		
	1	10 seconds continuous, Battery input Voltage < 18V	●		
	(Results / Symptoms) 1. Control Function – Startup impossibility (Checking list) 1. CS-74A (#1) – CN-51 (#1) Checking Open/Short				
707	1	(When Engine is equal or more than 400 rpm) 10 seconds continuous, Alternator Node I Measurement Voltage < 18V (In case 12v goods, Alternator Node I Measurement Voltage < 9V)	●		
	(Results / Symptoms) 1. Control Function – Battery charging circuit failure (Checking list) 1. CS-74A (#1) – CN-51 (#2) Checking Open/Short				

※ Some error codes are not applied to this machine.

G : General

C : Crawler Type

W : Wheel Type

DTC		Diagnostic Criteria	Application		
HCESPN	FMI		G	C	W
714	3	(Model Parameter) Mounting Acc. Dial 10 seconds continuous, Acc. Dial Measurement Voltage > 5.2V	●		
	4	(Model Parameter) Mounting Acc. Dial 10 seconds continuous, Acc. Dial Measurement Voltage < 0.3V	●		
	(Results / Symptoms) 1. Monitor – Acc. Dial Voltage display failure 2. Control Function – Engine rpm control failure (Checking list) 1. CN-142 (#B) – CN-52 (#23) Checking Open/Short				
722	4	(Detection) (When Travel Alarm (Buzzer) Sound is Off) 10 seconds continuous, Travel Alarm (Buzzer) Sound Relay drive unit Measurement Voltage ≤ 3.0V (Cancellation) (When Travel Alarm (Buzzer) Sound Relay is Off) 3 seconds continuous, Travel Alarm (Buzzer) Sound Relay drive unit Measurement Voltage > 3.0V	●		
	6	(Detection) (When Travel Alarm (Buzzer) Sound is On) 10 seconds continuous, Travel Alarm (Buzzer) Sound Relay drive current > 4.5 A (Cancellation) (When Travel Alarm (Buzzer) Sound is On) 3 seconds continuous, Travel Alarm (Buzzer) Sound Relay drive current ≤ 4.5 A	●		
(Results / Symptoms) 1. Control Function – Driving alarm operation failure (Checking list) 1. CN-81 (#1) – CN-52 (#13) Checking Open/Short 2. CN-81 (#2) – Fuse box (#31) Checking Open/Short					
831 (NA)	2	(When mounting the A/C Controller) 60 seconds continuous, A/C Controller Communication Data Error	●		
	(Results / Symptoms) 1. Control Function – A/C Controller operation failure (Checking list) 1. CN-11 (#8) – CN-51 (#22) Checking Open/Short 2. CN-11 (#7) – CN-51 (#32) Checking Open/Short				
840	2	60 seconds continuous, Cluster Communication Data Error	●		
	(Results / Symptoms) 1. Control Function – Cluster operation failure (Checking list) 1. CN-56A (#7) – CN-51 (#32) Checking Open/Short 2. CN-56A (#6) – CN-51 (#22) Checking Open/Short				

※ Some error codes are not applied to this machine.

G : General

C : Crawler Type

W : Wheel Type

DTC		Diagnostic Criteria	Application		
HCESPN	FMI		G	C	W
841 (NA)	2	10 seconds continuous, ECM Communication Data Error	●		
	(Results / Symptoms) 1. Control Function – ECM operation failure (Checking list) 1. CN-93 (#17) – CN-51 (#21) Checking Open/Short 2. CN-93 (#18) – CN-51 (#31) Checking Open/Short				
845 (NA)	2	(When mounting the I/O Controller 1) 60 seconds continuous, I/O Controller 1 Communication Data Error	●		
	(Results / Symptoms) 1. Control Function – I/O Controller 1 operation failure (Checking list) 1. CN-53 (#21) – CN-51 (#23) Checking Open/Short 2. CN-53 (#31) – CN-51 (#33) Checking Open/Short				
848 (NA)	2	(When mounting the Haptic Controller) 60 seconds continuous, Haptic Controller Communication Data Error	●		
	(Results / Symptoms) 1. Control Function – Haptic Controller operation failure (Checking list) 1. CN-8 (#2) – CN-51 (#22) Checking Open/Short 2. CN-8 (#3) – CN-51 (#32) Checking Open/Short				
850	2	(When mounting the RMCU) 60 seconds continuous, RMCU communication Data Error	●		
	(Results / Symptoms) 1. Control Function – RMCU operation failure (Checking list) 1. CN-125A (#3) – CN-51 (#22) Checking Open/Short 2. CN-125A (#11) – CN-51 (#32) Checking Open/Short				
861 (NA)	2	(When mounting the I/O Controller 2) 60 seconds continuous, I/O Controller 2 communication Data Error	●		
	(Results / Symptoms) 1. Control Function – I/O Controller 2 operation failure (Checking list) 1. CN-53 (#21) – CN-51 (#23) Checking Open/Short 2. CN-53 (#31) – CN-51 (#33) Checking Open/Short				

※ Some error codes are not applied to this machine.

G : General

C : Crawler Type

W : Wheel Type

DTC		Diagnostic Criteria	Application		
HCESPN	FMI		G	C	W
866	2	(When mounting the AAVM) 60 seconds continuous, AAVM communication Data Error	●		
	(Results / Symptoms) 1. Control Function – AAVM operation failure (Checking list) 1. CN-401 (#86) – CN-51 (#22) Checking Open/Short 2. CN-401 (#87) – CN-51 (#32) Checking Open/Short				
867	2	60 seconds continuous, RDU communication Data Error	●		
	(Results / Symptoms) 1. Control Function – RDU operation failure (Checking list) 1. CN-376 (#10) – CN-51 (#22) Checking Open/Short 2. CN-376 (#11) – CN-51 (#32) Checking Open/Short				
868	2	60 seconds continuous, Switch Controller communication Data Error	●		
	(Results / Symptoms) 1. Control Function – Switch Controller operation failure (Checking list) 1. CN-56A (#7) – CN-51 (#32) Checking Open/Short 2. CN-56A (#6) – CN-51 (#22) Checking Open/Short				
869	2	(When mounting the BKCU) 60 seconds continuous, BKCU communication Data Error	●		
	(Results / Symptoms) 1. Control Function – BKCU operation failure (Checking list) 1. CS-2B (#A) – CN-51 (#22) Checking Open/Short 2. CS-2B (#B) – CN-51 (#32) Checking Open/Short				

※ Some error codes are not applied to this machine.

G : General

C : Crawler Type

W : Wheel Type

## GROUP 13 ENGINE CONTROL SYSTEM

### 1. MCU (Machine Control Unit)

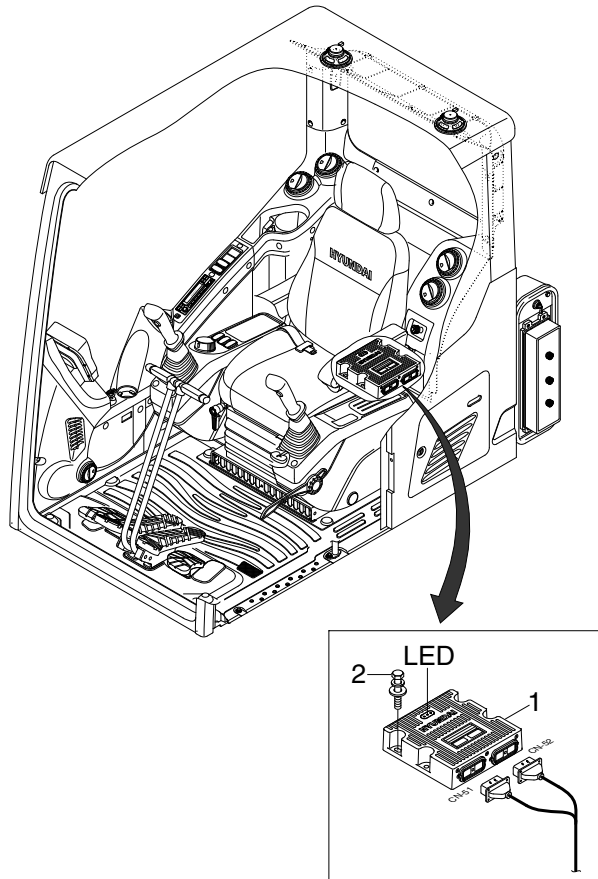

300S5MS13

### 2. MCU ASSEMBLY

- 1) To match the pump absorption torque with the engine torque, MCU varies EPPR valve output pressure, which control pump discharge amount whenever feedbacked engine speed drops under the reference rpm of each mode set.
- 2) Three LED lamps on the MCU display as below.

LED lamp	Trouble	Service
G is turned ON	Normal	-
G and R are turned ON	Trouble on MCU	· Change the MCU
G and Y are turned ON	Trouble on serial communication line	· Check if serial communication lines between MCU and cluster are disconnected
Three LED are turned OFF	Trouble on MCU power	· Check if the input power wire (24 V, GND) of MCU is disconnected · Check the fuse

G : green, R : red, Y : yellow

## GROUP 14 EPPR VALVE

### 1. PUMP EPPR VALVE

#### 1) COMPOSITION

EPPR (Electro Proportional Pressure Reducing) valve consists of electro magnet and spool valve installed at main pump.

##### (1) Electro magnet valve

Receive electric current from MCU and move the spool proportionally according to the specific amount of electric current value.

##### (2) Spool valve

Is the two way direction control valve for pilot pressure to reduce main pump flow.

When the electro magnet valve is activated, pilot pressure enters into flow regulator of main pump.

##### (3) Pressure and electric current value for each mode

Mode		Pressure		Electric current (mA)	Engine rpm (at accel dial 10)
		kgf/cm <sup>2</sup>	psi		
Standard (Stage : 1.0)	P	10	142	330 ± 30	1850 ± 50
	S	12 ± 3	171 ± 40	360 ± 30	1750 ± 50
	E	12 ± 3	171 ± 40	360 ± 30	1650 ± 50
Option (Stage : 2.0)	P	3	43	190 ± 30	1950 ± 50
	S	5 ± 3	71 ± 40	250 ± 30	1850 ± 50
	E	10 ± 3	142 ± 40	330 ± 30	1750 ± 50

### 2) HOW TO SWITCH THE STAGE (1.0 ↔ 2.0) ON THE CLUSTER

You can switch the EPPR valve pressure set by selecting the stage (1.0 ↔ 2.0).

- Management
  - Service menu



- Power shift (standard/option) : Power shift pressure can be set by option menu.

### 3) OPERATING PRINCIPLE (pump EPPR valve)

#### (1) Structure

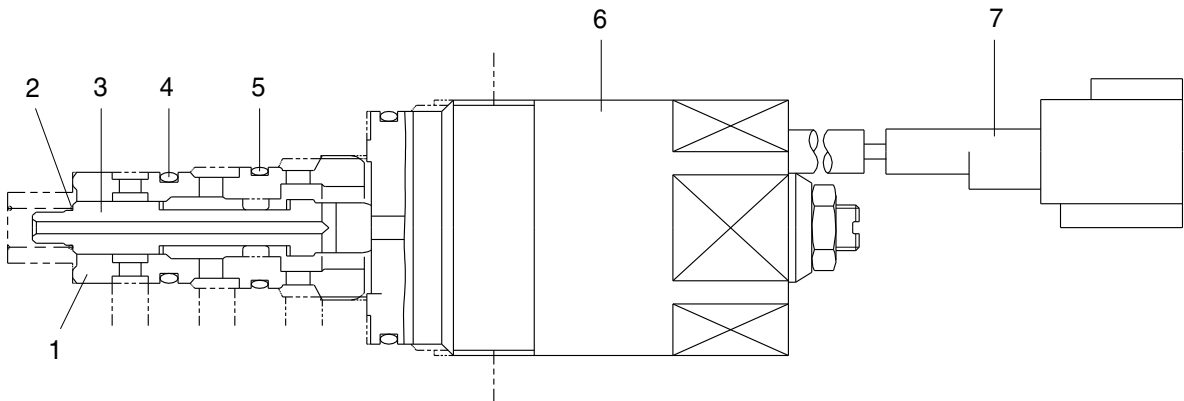

5-22(1)

- 1 Sleeve
- 2 Spring
- 3 Spool

- 4 O-ring
- 5 O-ring

- 6 Solenoid valve
- 7 Connector

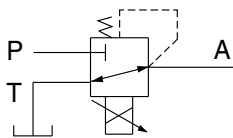

P Pilot oil supply line (pilot pressure)

T Return to tank

A Secondary pressure to flow regulator at main pump

#### (2) Neutral

Pressure line is blocked and A oil returns to tank.

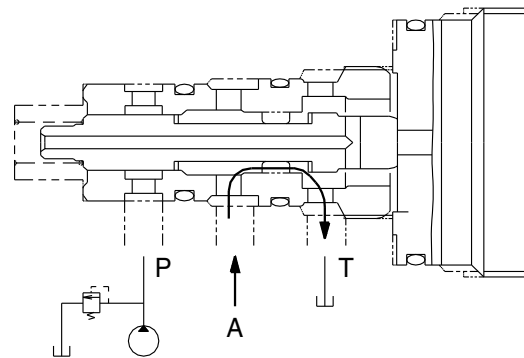
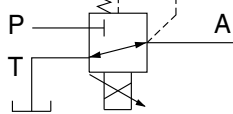

#### (3) Operating

Secondary pressure enters into A.

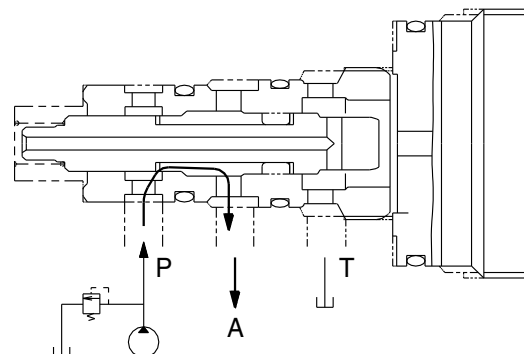
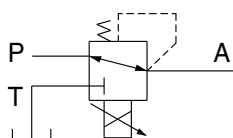

5-22(2)

#### 4) EPPR VALVE CHECK PROCEDURE

##### (1) Check electric current value at EPPR valve

- ① Disconnect connector CN-75 from EPPR valve.
- ② Insert the adapter to CN-75 and install multimeter as figure.
- ③ Start engine.
- ④ Set S-mode and cancel auto decel mode.
- ⑤ Position the multimodal dial at 10.
- ⑥ If rpm display show approx  $1850 \pm 50$  rpm check electric current at bucket circuit relief position.
- ⑦ Check electric current at bucket circuit relief position.

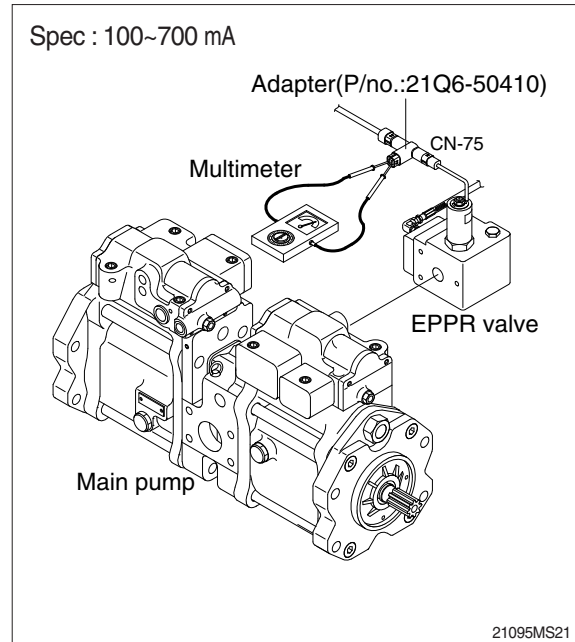

##### (2) Check pressure at EPPR valve

- ① Remove plug and connect pressure gauge as figure.
  - Gauge capacity : 0 to 50 kgf/cm<sup>2</sup>  
(0 to 725 psi)
- ② Start engine.
- ③ Set S-mode and cancel auto decel mode.
- ④ Position the multimodal dial at 10.
- ⑤ If tachometer show approx  $1850 \pm 50$  rpm check pressure at relief position of bucket circuit by operating bucket control lever.
- ⑥ If pressure is not correct, adjust it.
- ⑦ After adjust, test the machine.

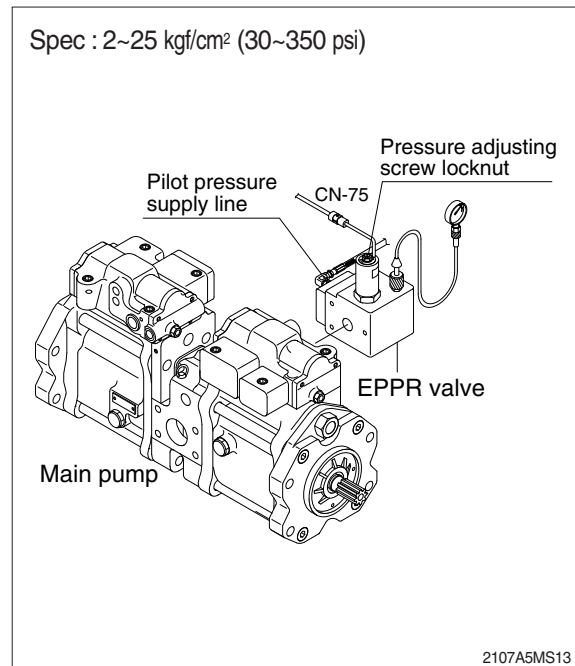



## 2. BOOM PRIORITY EPPR VALVE

### 1) COMPOSITION

The boom priority EPPR valve is built in a manifold and mainly consisting of valve body and coil. This EPPR valve installed under the solenoid valve.

### 2) CONTROL

The boom priority EPPR valve has to be controlled by a specific electronic amplifier card, which is supplying the coil with a current 580 mA at 30Ω and 24 V.

### 3) OPERATING PRINCIPLE

#### (1) Structure

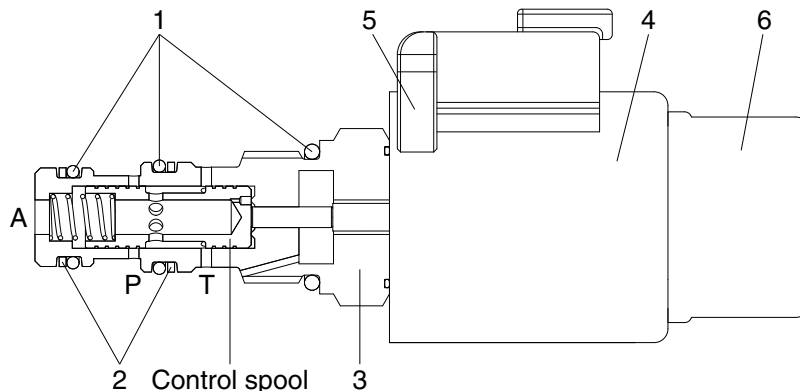

21095MS14

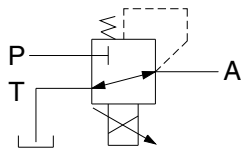

P : Pilot supply line  
T : Return to tank  
A : Secondary pressure to flow MCV

- |                |              |             |
|----------------|--------------|-------------|
| 1 O-ring       | 3 Valve body | 5 Connector |
| 2 Support ring | 4 Coil       | 6 Cover cap |

#### (2) Operation

In de-energized mode the inlet port (P) is closed and the outlet port (A) is connected to tank port (T).

In energized mode the solenoid armature presses onto the control spool with a force corresponding to the amount of current. This will set a reduced pressure at port A. The setting is proportional to the amount of current applied.

#### (3) Maximum pressure relief

If a pressure from outside is applied on port A the valve may directly switch to tank port (T) and protect the system before overload.

## 2) EPPR VALVE CHECK PROCEDURE

### (1) Check electric current value at EPPR valve

- ① Disconnect connector CN-133 from EPPR valve.
- ② Insert the adapter to CN-133 and install multimeter as figure.
- ③ Start engine.
- ④ Set S-mode and cancel auto decel mode.
- ⑤ If rpm display approx  $1850 \pm 50$  rpm disconnect one wire harness from EPPR valve.
- ⑥ Check electric current in case of combined boom up and swing operation.

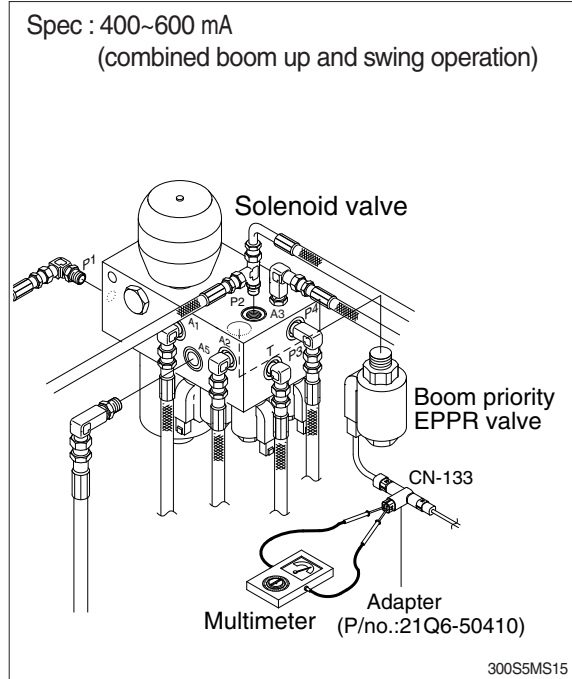

### (2) Check pressure at EPPR valve

- ① Remove hose from A5 port and connect pressure gauge as figure.
  - Gauge capacity : 0 to 50 kgf/cm<sup>2</sup>  
(0 to 725 psi)
- ② Start engine.
- ③ Set S-mode and cancel auto decel mode.
- ④ If rpm display approx  $1850 \pm 50$  rpm check pressure (In case of combined boom up and swing operation).
- ⑤ If pressure is not correct, adjust it.
- ⑥ After adjust, test the machine.

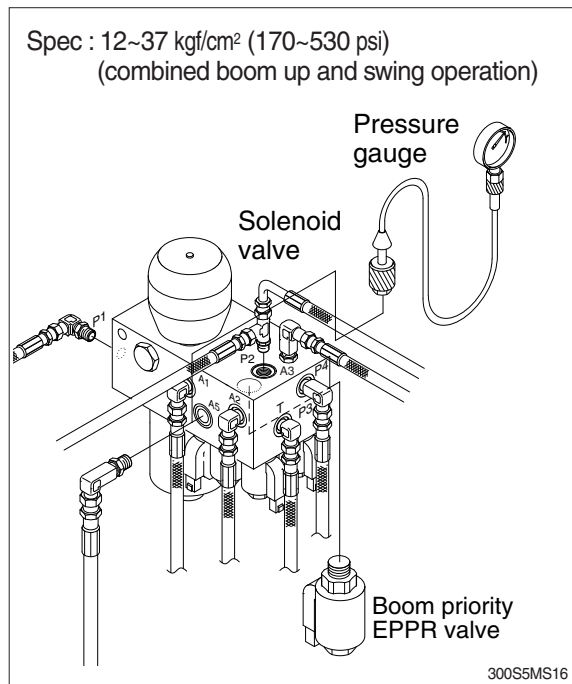

## GROUP 15 MONITORING SYSTEM

### 1. OUTLINE

Monitoring system consists of the monitor part and switch part.

The monitor part gives warnings when any abnormality occurs in the machine and informs the condition of the machine.

Various select switches are built into the monitor panel, which act as the control portion of the machine control system.

### 2. CLUSTER

#### 1) MONITOR PANEL

Normal type

Time display



Warning lamps  
(see page 5-53)

Gauge(see page 5-50)  
Main menu(see page 5-64)

Tripmeter  
(see page 5-78)

Pilot lamps  
(see page 5-56)

Switches  
(see page 5-59)

220S5CD501B

Premium type

Time display



Warning lamps  
(see page 5-53)

Gauge(see page 5-50)  
Main menu(see page 5-64)

Tripmeter  
(see page 5-78)

Pilot lamps  
(see page 5-56)

Switches  
(see page 5-59)

220S5CD01C

※ The warning lamp pops up and/or blinks and the buzzer sounds when the machine has a problem. The warning lamp blinks until the problem is cleared. Refer to page 5-53 for details.

## 2) CLUSTER CHECK PROCEDURE

### (1) Start key : ON

#### ① Check monitor

- a. Buzzer sounding for 4 seconds with HYUNDAI logo on cluster.
- ※ If the ESL mode is set to the enable, enter the password to start engine.

#### ② After initialization of cluster, the operating screen is displayed on the LCD.

Also, self diagnostic function is carried out.

- a. Engine rpm display : 0 rpm
- b. Engine coolant temperature gauge : White range
- c. Hydraulic oil temperature gauge : White range
- d. Fuel level gauge : White range

#### ③ Indicating lamp state

- a. Power mode pilot lamp : E mode or U mode
- b. Work mode pilot lamp : General operation mode (bucket)
- c. Travel speed pilot lamp : Low (turtle)

### (2) Start of engine

#### ① Check machine condition

- a. RPM display indicates at present rpm
- b. Gauge and warning lamp : Indicate at present condition.
- ※ When normal condition : All warning lamp OFF
- c. Work mode selection : General work
- d. Power mode selection : E mode or U mode
- e. Travel speed pilot lamp : Low (turtle)

#### ② When warming up operation

- a. Warming up pilot lamp : ON
- b. After engine started, engine speed increases to 1200 rpm.
- ※ Others same as above.

#### ③ When abnormal condition

- a. The warning lamp lights up and the buzzer sounds.
- b. If BUZZER STOP switch is pressed, buzzer sound is canceled but the lamp warning lights up until normal condition.
- ※ The pop-up warning lamp moves to the original position and blink when the buzzer stop switch is pushed. Also the buzzer stops.

### 3. CLUSTER CONNECTOR

#### 1) NORMAL TYPE

##### (1) CN-56A

No.	Name	Signal
1	Battery 24V	20~32Vdc
2	Power IG {24V}	20~32Vdc
3	GND	-
4	N.C	-
5	N.C	-
6	CAN 2 (H)	0~5Vdc
7	CAN 2 (L)	dc
8	N.C	-
9	N.C	-
10	N.C	-
11	N.C	-
12	N.C	-

##### (2) CN-56B

No.	Name	Signal
1	CAM + 6.5V	6.3~6.7Vdc
2	CAM GND	-
3	CAM DIFF (H)	0~5Vdc
4	CAM DIFF (L)	0~5Vdc
5	CAM 1	NTSC signal
6	CAM 2	NTSC signal
7	CAM 3	NTSC signal
8	CAM shield	0~5Vdc

NTSC : National Television System Committee

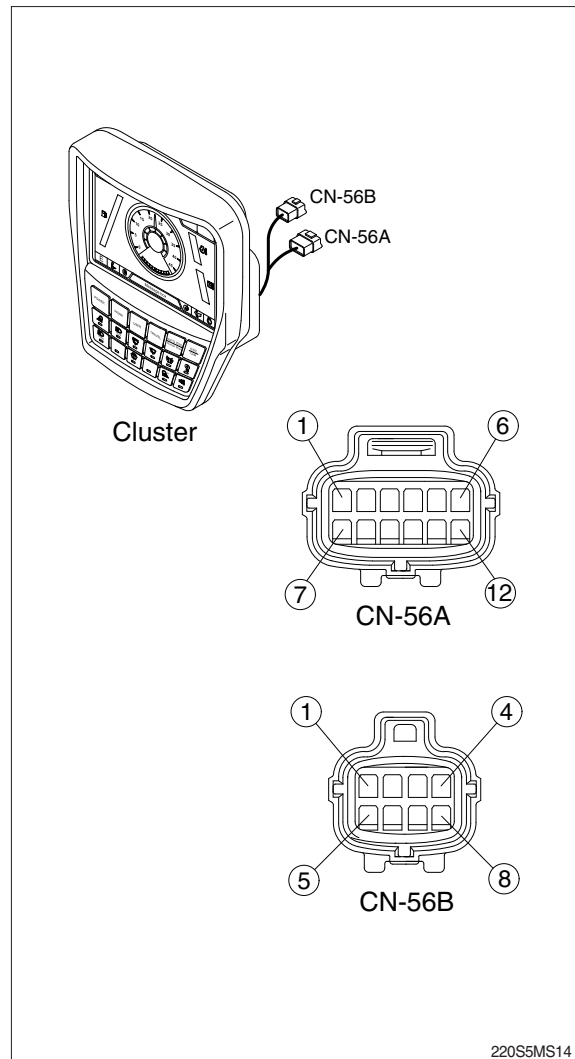

220S5MS14

## 2) PREMIUM TYPE

### (1) CN-56A

No.	Name	Signal
1	Battery 24V	20~32Vdc
2	Power IG {24V}	20~32Vdc
3	GND	-
4	CAN 1 (H)	0~5Vdc
5	CAN 1 (L)	0~5Vdc
6	CAN 2 (H)	0~5Vdc
7	CAN 2 (L)	20~32Vdc
8	N.C	-
9	N.C	-
10	Aux left	0~5V
11	Aux right	0~5V
12	Aux GND	-

### (2) CN-56B

No.	Name	Signal
1	CAM + 6.5V	6.3~6.7Vdc
2	CAM GND	-
3	CAM DIFF (H)	0~5V
4	CAM DIFF (L)	0~5V
5	CAM 1	NTSC signal
6	CAM 2	NTSC signal
7	CAM 3	NTSC signal
8	CAM shield	0~5Vdc

NTSC : National Television System Committee

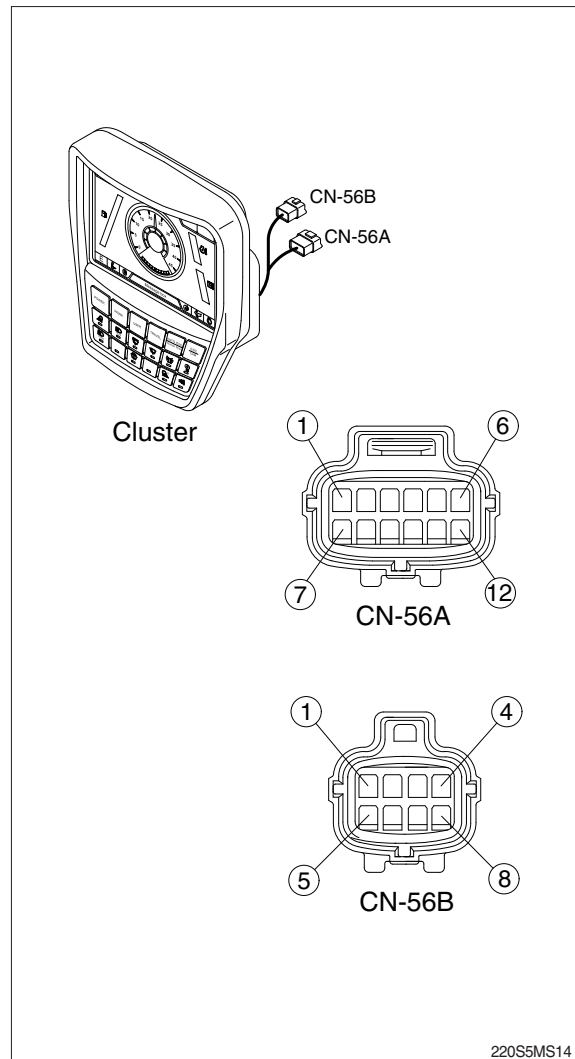

220S5MS14

## 2) GAUGE

### (1) Operation screen

When you first turn starting switch ON, the operation screen will appear.

#### Normal type



220S3CD551B

#### Premium type

##### Default



##### Option



220S3CD151A

- |                                    |                     |
|------------------------------------|---------------------|
| 1 RPM / Speed gauge                | 5 Tripmeter display |
| 2 Engine coolant temperature gauge | 6 Eco gauge         |
| 3 Hydraulic oil temperature gauge  | 7 Accel dial gauge  |
| 4 Fuel level gauge                 |                     |

※ Operation screen type can be set by the screen type menu of the display (premium type). Refer to page 5-76 for details.

### (2) RPM / Speed gauge

#### Normal type



① This display the engine speed.

#### Premium type



290F3CD549

### (3) Engine coolant temperature gauge



Normal type

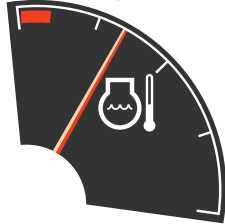

Premium type



220S3CD553

- ① This gauge indicates the temperature of coolant.
    - White range : 40-100°C (104-212°F)
    - Red range : Above 100°C (212°F)
  - ② If the indicator is in the red range or  lamp pops up and the buzzer sounds turn OFF the engine and check the engine cooling system.
- ※ If the gauge indicates the red range or  lamp blinks in red even though the machine is on the normal condition, check the electric device as that can be caused by the poor connection of electricity or sensor.

### (4) Hydraulic oil temperature gauge



Normal type



Premium type



220S3CD554

- ① This gauge indicates the temperature of hydraulic oil.
    - White range : 40-100°C(104-212°F)
    - Red range : Above 100°C(212°F)
  - ② If the indicator is in the red range or  lamp pops up and the buzzer sounds reduce the load on the system. If the gauge stays in the red range, stop the machine and check the cause of the problem.
- ※ If the gauge indicates the red range or  lamp blinks in red even though the machine is on the normal condition, check the electric device as that can be caused by the poor connection of electricity or sensor.



### (5) Fuel level gauge



Normal type

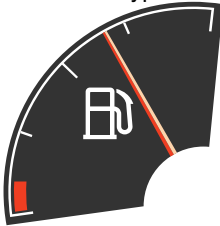

Premium type



220S3CD555

- ① This gauge indicates the amount of fuel in the fuel tank.
  - ② Fill the fuel when the red range, or  lamp pops up and the buzzer sounds.
- ※ If the gauge indicates the red range or  lamp blinks in red even though the machine is on the normal condition, check the electric device as that can be caused by the poor connection of electricity or sensor.

### (6) Tripmeter display

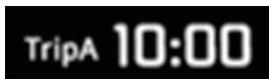

290F3CD56

- ① This displays the engine the tripmeter.
- ※ Refer to page 5-78 for details.

### (7) Eco gauge



290F3CD58

- ① This gauge indicates the fuel consumption rate and machine load status. So that operators can be careful with fuel economy.
- ② The fuel consumption rate or machine load is higher, the number of segment is increased.
- ③ The color of Eco gauge indicates operation status.
  - White : Idle operation
  - Green : Economy operation
  - Yellow : Non-economy operation at a medium level.
  - Red : Non-economy operation at a high level.

### (8) Accel dial gauge



290F3CD59

- ① This gauge indicates the level of accel dial.

### 3) WARNING LAMPS

#### Normal type





220S3CD503B

#### Premium type



220S3CD03C

#### ※ Warning lamps and buzzer





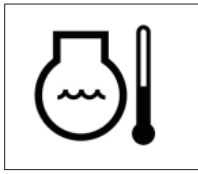

Warnings	When error happened	Lamps and buzzer
All warning lamps except below	Warning lamp pops up on the center of the LCD and the buzzer sounds	<ul style="list-style-type: none"> <li>The pop-up warning lamp moves to the original position and blinks, and the buzzer stops when ;</li> <li>- the buzzer stop switch  is pushed</li> <li>- the lamp of the LCD is touched</li> </ul>
	Warning lamp pops up on the center of the LCD and the buzzer sounds	※ Refer to page 5-54 for details.

※ Refer to page 5-60 for the buzzer stop switch. 

### (1) Engine coolant temperature warning lamp







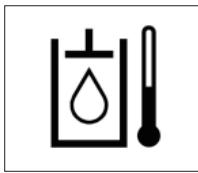

290F3CD61

- ① Engine coolant temperature warning is indicated two steps.
  - 100°C over : The  lamp pops up and the buzzer sounds.
  - 102°C over : The  lamp pops up and the buzzer sounds.
- ② The pop-up ,  lamps move to the original position and blinks when the buzzer stop switch  is pushed. And the buzzer stops and ,  lamps keep blink.
- ③ Check the cooling system when the lamps keep blink.

### (2) Hydraulic oil temperature warning lamp



290F3CD62

- ① Hydraulic oil temperature warning is indicated two steps.
  - 100°C over : The  lamp pops up and the buzzer sounds.
  - 105°C over : The  lamp pops up and the buzzer sounds.
- ② The pop-up ,  lamps move to the original position and blinks when the buzzer stop switch  is pushed. And the buzzer stops and ,  lamps keep blink.
- ③ Check the hydraulic oil level and hydraulic oil cooling system.

### (3) Fuel level warning lamp

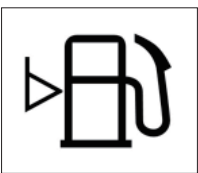

290F3CD63

- ① This warning lamp pops up and the buzzer sounds when the level of fuel is below 55 ℓ (14.5 U.S. gal).
- ② Fill the fuel immediately when the lamp blinks.

### (4) Emergency warning lamp



290F3CD64

- ① This warning lamp pops up and the buzzer sounds when each of the below warnings is happened.
  - Engine coolant overheating (over 104°C)
  - Hydraulic oil overheating (over 105°C)
  - MCU input voltage abnormal
  - Cluster communication data error
- ※ **The pop-up warning lamp moves to the original position and blinks when the buzzer stop switch  is pushed. And the buzzer stops.**
- ② When this warning lamp blinks, machine must be checked and serviced immediately.

#### (5) Engine oil pressure warning lamp

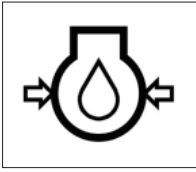

290F3CD65

- ① This warning lamp pops up and the buzzer sounds when the engine oil pressure is low.
- ② If the lamp blinks, shut OFF the engine immediately. Check oil level.

#### (6) Battery charging warning lamp

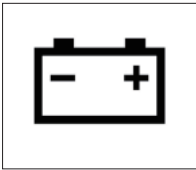

290F3CD67

- ① This warning lamp pops up and the buzzer sounds when the battery charging voltage is low.
- ② Check the battery charging circuit when this lamp blinks.

#### (7) Air cleaner warning lamp



290F3CD68

- ① This warning lamp pops up and the buzzer sounds when the filter of air cleaner is clogged.
- ② Check the filter and clean or replace it.

#### (8) Overload warning lamp (opt)



290F3CD69

- ① When the machine is overload, the overload warning lamp pops up and the buzzer sounds during the overload switch is ON. (if equipped)
- ② Reduce the machine load.

## 4) PILOT LAMPS

### Normal type

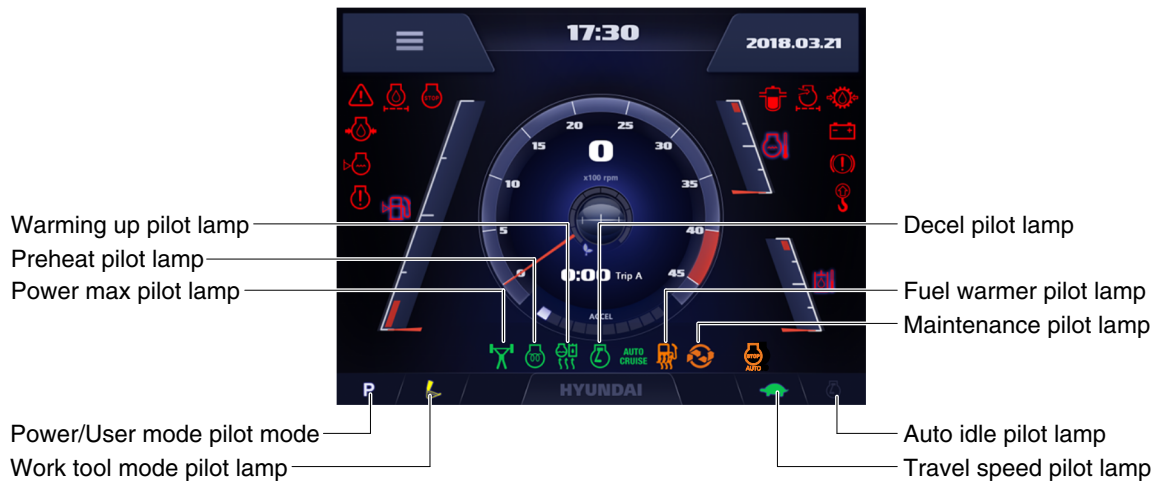





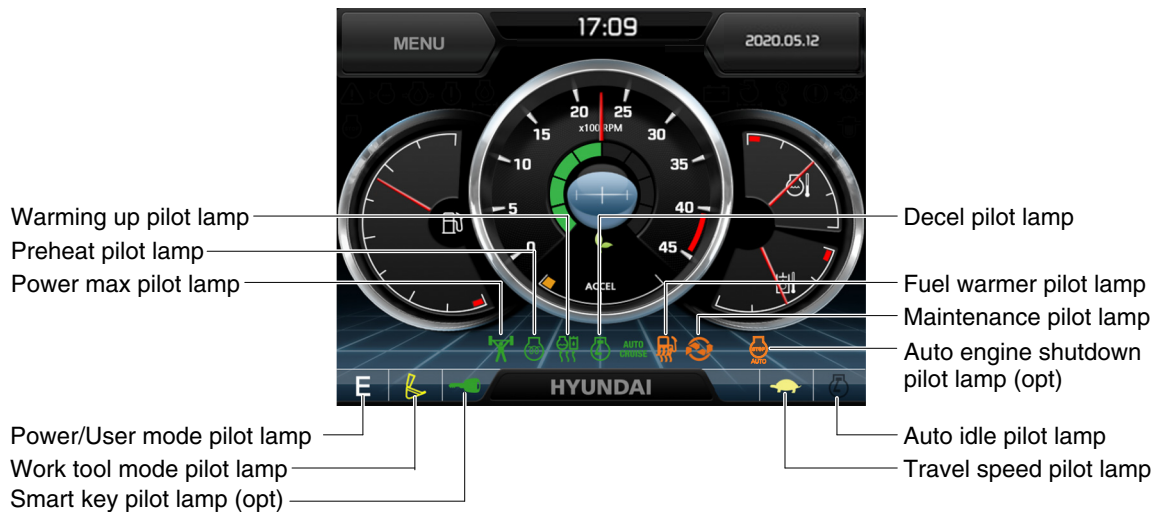







220S3CD574B

### Premium type



220S3CD74C

### (1) Mode pilot lamps

No	Mode	Pilot lamp	Selected mode
1	Power mode		Heavy duty power work mode
			Standard power mode
			Economy power mode
2	User mode		User preferable power mode
3	Work tool mode		General operation - IPC speed mode
			General operation - IPC balance mode
			General operation - IPC efficiency mode
			Breaker operation mode
			Crusher operation mode
4	Travel mode		Low speed traveling
			High speed traveling
5	Auto idle mode		Auto idle

### (2) Power max pilot lamp



290F3CD78

- ① The lamp will be ON when pushing power max switch on the LH RCV lever.
- ② The power max function is operated maximum 8 seconds.
- ※ Refer to the operator's manual page 3-35 for power max function.

### (3) Preheat pilot lamp



290F3CD79

- ① Turning the start key switch to ON position starts preheating when pre-heater switch is pressed.
- ② After this lamp goes OFF, turn the start key switch to START position.

### (4) Warming up pilot lamp

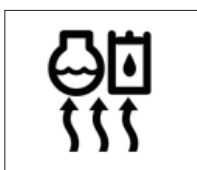

290F3CD80

- ① This lamp is turned ON when the coolant temperature is below 30°C (86°F).
- ② The automatic warming up is cancelled when the engine coolant temperature is above 30°C, or when 10 minutes have passed since starting the engine.

#### (5) Decel pilot lamp



290F3CD81

- ① Operating one touch decel switch on the RCV lever makes the lamp ON.
  - ② Also, the lamp will be ON and engine speed will be lowered automatically to save fuel consumption when all levers and pedals are at neutral position, and the auto idle function is selected.
- ※ **One touch decel is not available when the auto idle pilot lamp is turned ON.**
- ※ **Refer to the operator's manual page 3-35.**

#### (6) Fuel warmer pilot lamp

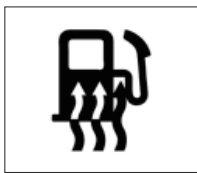

290F3CD82

- ① This lamp is turned ON when the coolant temperature is below 10°C (50°F) or the hydraulic oil temperature 20°C (68°F).
- ② The automatic fuel warming is cancelled when the engine coolant temperature is above 60°C, and the hydraulic oil temperature is above 45°C since the start switch was ON position.

#### (7) Maintenance pilot lamp



290F3CD83

- ① This lamp will be ON when the consuming parts are needed to change or replace. It means that the change or replacement interval of the consuming parts remains below 30 hours.
  - ② Check the message in maintenance information of main menu. Also, this lamp lights ON for 3 minutes when the start switch is ON position.
- ※ **Refer to the page 5-71.**

#### (8) Smart key pilot lamp (premium type, opt)

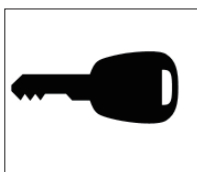

290F3CD214

- ① This lamp is ON when the engine is started by the start button.
  - ② This lamp is red when the authentication fails, green when succeeds.
- ※ **Refer to the page 5-72.**

#### (9) Auto engine shutdown pilot lamp (opt)



220A3CD202A

- ① This lamp lights up when the auto engine shutdown is activated.
- ※ **Refer to page 5-68.**



## 5) SWITCHES

### Normal type



220S3CD586

### Premium type



220S3CD86B

※ When some of the switches are selected, the pilot lamps are displayed on the LCD. Refer to the page 5-56 for details.





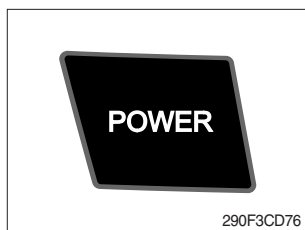

### (1) Power mode switch

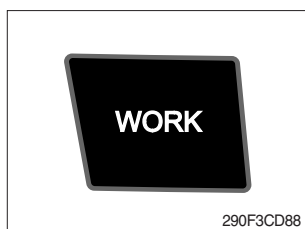

- ① This switch is to select the machine power mode and selected power mode pilot lamp is displayed on the pilot lamp position.
  - P : Heavy duty power work.
  - S : Standard power work.
  - E : Economy power work.
- ② The pilot lamp changes E → S → P → E in order.

### (2) Work mode switch



- ① This switch is to select the machine work mode, which shifts from general operation mode to optional attachment operation mode.
  -  : General operation mode
  -  : Breaker operation mode (if equipped)
  -  : Crusher operation mode (if equipped)
  - Not installed : Breaker or crusher is not installed.

※ Refer to the operator's manual page 4-7 for details.

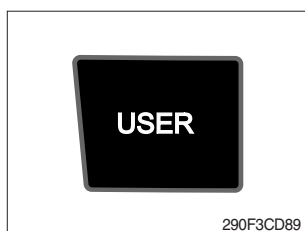

### (3) User mode switch

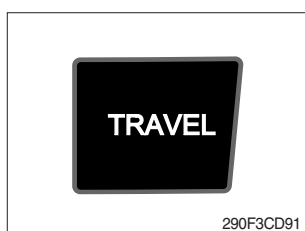

- ① This switch is used to memorize the current machine operating status in the MCU and activate the memorized user mode.
  - Memory : Push more than 2 seconds.
  - Action : Push within 2 seconds.
  - Cancel : Push this switch once more within 2 seconds.
- ② Refer to the page 5-66 for another set of user mode.

### (4) Travel speed switch



- ① This switch is used to select the travel speed alternatively.
  -  : Low speed
  -  : High speed

※ Do not change the setting of the travel speed switch. Machine stability may be adversely affected.

▲ Personal injury can result from sudden changes in machine stability.

### (5) Auto idle/ buzzer stop switch



- ① This switch is used to activate or cancel the auto idle function.
  - Pilot lamp ON : Auto idle function is activated.
  - Pilot lamp OFF : Auto idle function is cancelled.
- ② The buzzer sounds when the machine has a problem. In this case, push this switch and buzzer stops, but the warning lamp blinks until the problem is cleared.

### (6) Escape/Camera switch

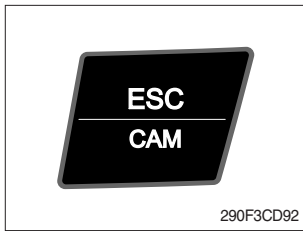

- ① This switch is used to return to the previous menu or parent menu.
- ② In the operation screen, pushing this switch will display the view of the camera on the machine (if equipped). Please refer to page 5-78 for the camera.
- ③ If the camera is not installed, this switch is used only ESC function.

### (7) Work light switch



- ① This switch is used to operate the work light.
- ② The pilot lamp is turned ON when operating the switch.

### (8) Head light switch



- ① This switch is used to operate the head light.
- ② The pilot lamp is turned ON when operating the switch.

### (9) Intermittent wiper switch



- ① This switch is used to wipe operates intermittently.
- ② The pilot lamp is turned ON when operating the switch.

### (10) Wiper switch



- ① This switch is used to operate the window wiper.
  - ② Note that the wiper will self-park when switched off.
  - ③ The pilot lamp is turned ON when operating the switch.
- ※ If the wiper does not operate with the switch in ON position, turn the switch OFF immediately. Check the cause. If the switch remains ON, motor failure can result.

### (11) Washer switch

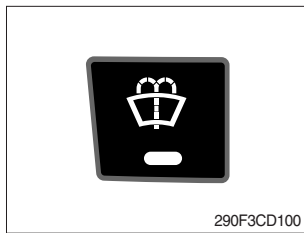

- ① The washer liquid is sprayed and the wiper is operated only while pressing this switch.
- ② The pilot lamp is turned ON when operating the switch.

### (12) Cab light switch

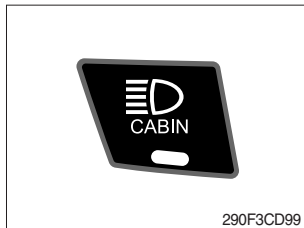

- ① This switch turns ON the cab light on the cab.
- ② The pilot lamp is turned ON when operating the switch.

### (13) Beacon switch (option)

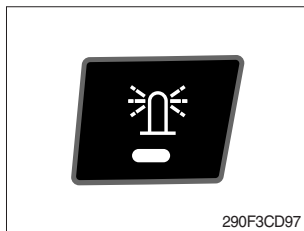

- ① This switch turns ON the rotary light on the cab.
- ② The pilot lamp is turned ON when operating the switch.

### (14) Overload switch (option)

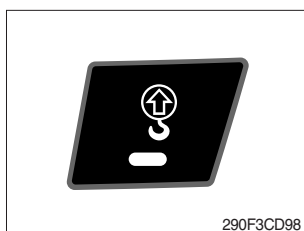

- ① When this switch turned ON, buzzer makes sound and overload warning lamp comes ON in case that the machine is overload.
  - ② When it turned OFF, buzzer stops and warning lamp goes out.
- ▲ Overloading the machine could impact the machines stability which could result in tipover hazard. A tipover hazard could result in serious injury or death. Always activate the overload warning device before you handle or lift objects.**

### (15) Travel alarm switch

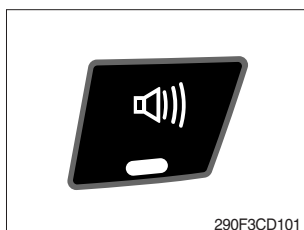

- ① This switch is to activate travel alarm function surrounding when the machine travels to forward and backward.
- ② On pressing this switch, the alarm operates only when the machine is traveling.
- ③ The pilot lamp is turned ON when operating the switch.

**(16) Main menu quick touch switch**



- ① This switch is to activate the main menu in the cluster.
- ※ **Refer to the page 5-65.**

**(17) Pre-heater switch**

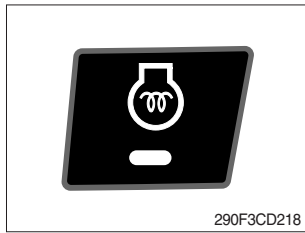

- ① This switch activates pre-heat function.
- ※ **Recommend to use the function in cold weather.**

## 6) MAIN MENU

- ※ On the operation screen, tap MENU to access the main menu screen.  
On the sub menu screen, you can tap the menu bar to access functions or applications.

### Normal type

#### Operation screen



Tap  
MENU

#### Main menu screen

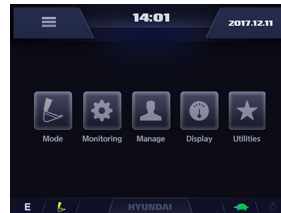

#### Sub menu screen

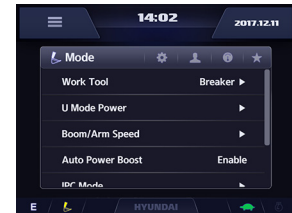

220S3CD502

### Premium type

#### Operation screen



Tap  
MENU

#### Main menu screen



#### Sub menu screen



220S3CD102A

## (1) Structure

No	Main menu	Sub menu	Description
1	  <p>Mode 290S3CD103</p>	Work tool U mode power Boom/Arm speed Auto power boost IPC mode Auto engine shutdown (option) Initial mode Emergency mode	Breaker, Crusher, Not installed User mode only Boom speed Enable, Disable Speed mode, Balance mode, Efficiency mode One time, Always, Disable Key on initial mode, Accel initial mode / step Switch function
2	  <p>Monitoring 290S3CD104</p>	Active fault Logged fault Delete logged fault Monitoring	MCU, ★AAVM (option) MCU, ★AAVM (option) All logged fault delete, Initialization canceled Machine information, Switch status, Output status,
3	  <p>Management 290S3CD105</p>	Fuel rate information Maintenance information Machine security Machine information  Contact Service menu  Clinometer Update	General record, Hourly, Daily, Mode record Replacement, Change interval oils and filters ESL mode setting, Password change Model, MCU, Monitor, RMCU, Relay drive unit, ★AAVM (option) A/S phone number, A/S phone number change Power shift, Operating hour, Breaker mode pump acting, EPPR current level, Overload pressure Clinometer setting Cluster, ETC device
4	  <p>Display 290S3CD106</p>	Display item Clock Brightness Unit setup Language selection ★Screen type	Engine speed, Tripmeter A, Tripmeter B, Tripmeter C Clock Manual, Auto Temperature, Pressure, Flow, Distance, Date format Korean, English, Chinese, ETC A type, B type
5	  <p>Utilities 290S3CD107</p>	Tripmeter Camera setting AUX Manual	3 kinds (A, B, C) Number of active, Display order, ★AAVM (option)

★ : premium type

## (2) Mode setup

※ Illustrations are based on the premium type cluster.

### ① Work tool

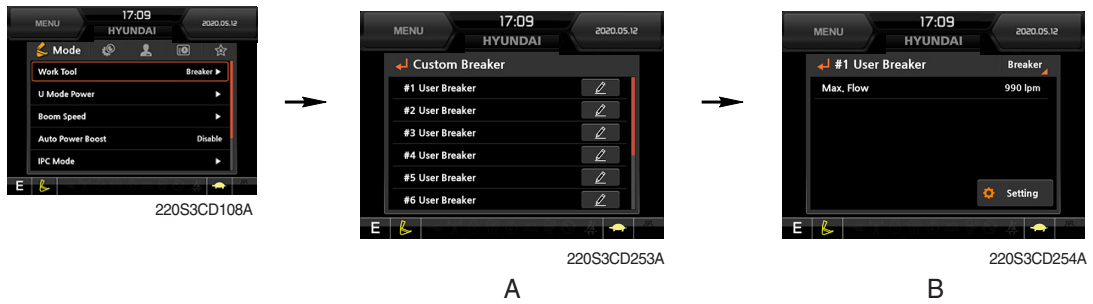

- Select on installed optional attachment
  - A : It can set the user's attachment.  
It is available in setting #1~#10.
  - B : Max flow - Set the maximum flow for the attachment.  
Relief pressure - Set the relief pressure.

### ② U mode power

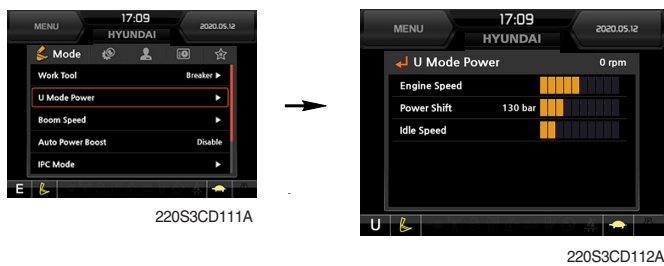

Step (■)	Engine speed (rpm)	Idle speed (rpm)	Power shift (bar)
1	1400	1000	0
2	1500	1050 (auto idle)	3
3	1550	1100	6
4	1650	1150	9
5	1700	1200	12
6	1750	1250	16
7	1800	1300	20
8	1850	1350	26
9	1900	1400	32
10	1950	1450	38

- Engine high idle rpm, auto idle rpm and pump torque (power shift) can be modulated and memorized separately in U-mode.
- U-mode can be activated by user mode switch.

※ One touch decel & low idle : 1000 rpm

### ③ Boom speed

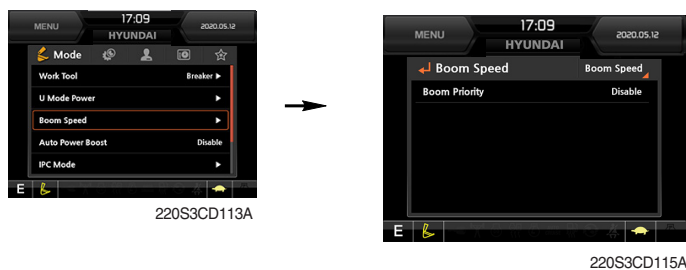

- Boom speed
  - Boom priority function can be activated or cancelled  
Enable - Boom up speed is automatically adjusted as working conditions by the MCU.  
Disable - Normal operation

#### ④ Auto power boost

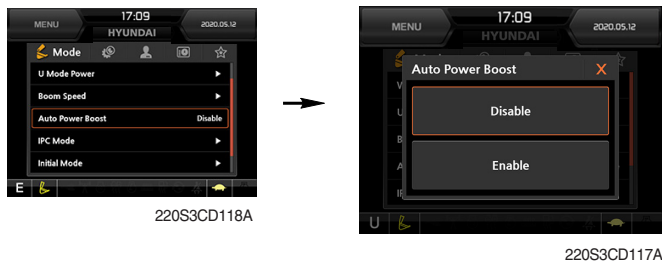

- The power boost function can be activated or cancelled.
  - Enable - The digging power is automatically increased as working conditions by the MCU. It is operated max 8 seconds.
  - Disable - Not operated.

#### ⑤ IPC mode



- The IPC mode can be selected by this menu.
  - Speed mode
  - Balance mode (default)
  - Efficiency mode
- This mode is applied only general operation mode of the work tool mode.
- ※ Please update the cluster programs if this mode is not displayed in the mode setup menu. Refer to the page 5-74.



### ⑥ Automatic engine shutdown (option)



- The automatic engine shutdown function can be set by this menu.
  - One time
  - Always
  - Disable
  - Wait time setting : Max 40 minutes, min 2 minutes

### ⑦ Initial mode

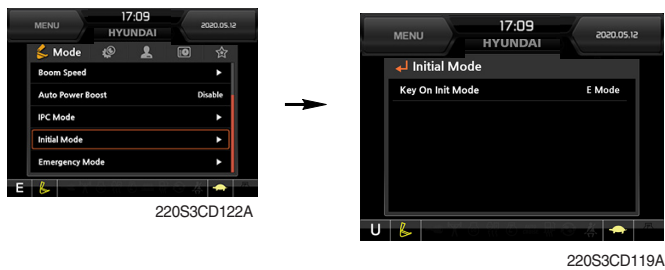

- **Key on initial mode**
  - Selected the power mode is activated when the engine is started.

### ⑧ Emergency mode



- This mode can be used when the switches are abnormal on the cluster.
- The cluster switches will be selected by touched each icon.

### (3) Monitoring

#### ① Active fault

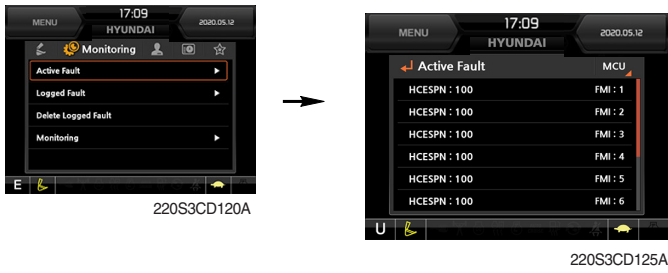

- The active faults of the MCU and AAVM (option) can be checked by this menu.

#### ② Logged fault

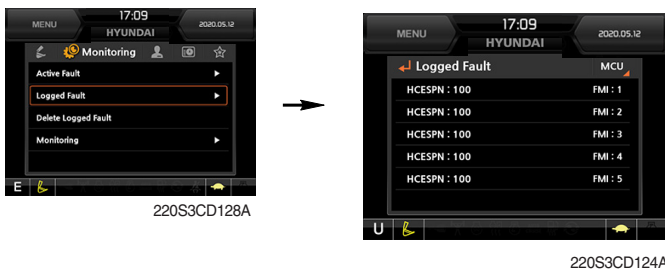

- The logged faults of the MCU and AAVM (option) can be checked by this menu.

#### ③ Delete logged fault



- The logged faults of the MCU and AAVM (option) can be deleted by this menu.

#### ④ Monitoring

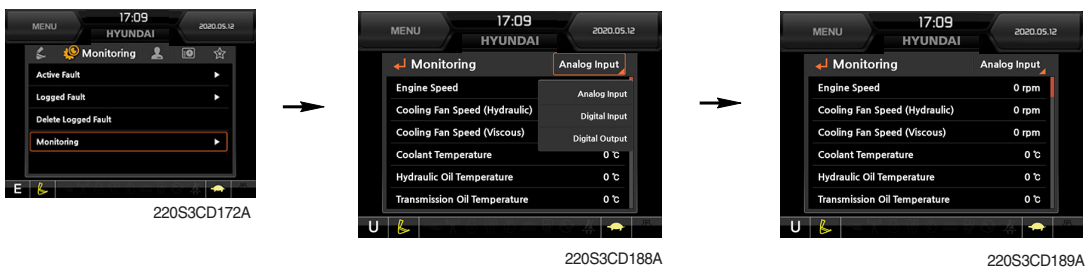

- The machine status such as the engine rpm, oil temperature, voltage and pressure etc. can be checked by this menu (Analog input).
- The switch status or output status can be confirmed by this menu (Digital input & Digital output).
- The activated switch or output pilot lamps ● are light ON.

#### (4) Management

##### ① Fuel rate information



A

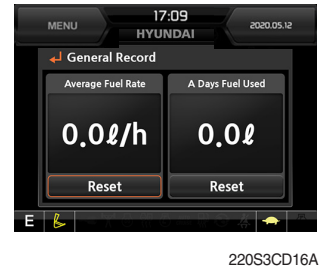

B



C



D



220S3CD19A

- **General record (A)**

- Average fuel rate (left) (from "Reset" to now)  
Fuel consumption divided by engine run time (service meter time).
- A days fuel used (right)  
Fuel consumption from 24:00 (or "Reset" time) to now (MCU real time).

- **Hourly record (B)**

- Hourly fuel rates for past 12 hours (service meter time).
- No record during key-off time.
- One step shift to the right for every one hour.
- Automatic deletion for 12 hours earlier data.
- All hourly records deletion by "Reset".

- **Daily record (C)**

- Daily fuel consumption for past seven days (MCU real time).
- No record during key-off time.
- One step shift to the right at 24:00 for every day.
- Automatic deletion for 7 days earlier data.
- All daily records deletion by "Reset".

- **Mode record (D)**

- Average fuel rate for each power mode/accel dial (at least 7) from "Reset" to now.
- No record during idle.
- All mode records deletion by "Reset".

## ② Maintenance information



220S3CD131A



Item	Interval	Elapse	Count	Alarm
Engine Oil	2000	6	0	●
Reduction Gear Oil	2000	6	0	○
Swing Gear Oil	2000	6	0	○
Hydraulic Oil	3000	6	0	○
Pilot Line Filter	3000	6	0	○

220S3CD132A



Item	Interval	Elapse	Count	Alarm
Engine Oil	2000	6	0	●

Hour-Meter at Latest Replacement : Never

1	0 hour	2	0 hour	3	0 hour
4	0 hour	5	0 hour	6	0 hour
7	0 hour	8	0 hour	9	0 hour

Replacement      Change Interval

220S3CD133A

- Alarm lamp ( ● ) is ON when oil or filter needs to be changed or replaced.
  - Replacement : The elapsed time will be reset to zero (0).
  - Change interval : The change or replace interval can be changed in the unit of 50 hours.
- ※ Refer to Maintenance chart for further information of maintenance interval.

### ③ Machine security

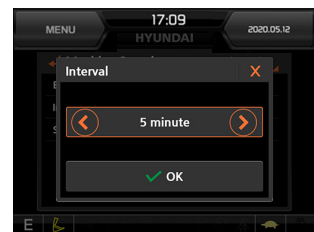

#### ESL mode setting

- ESL : Engine Starting Limit
- ESL mode is designed to be a theft deterrent or will prevent the unauthorized operation of the machine.
- If the ESL mode was selected Enable, the password will be required when the start switch is turned ON.
- **Machine security**
  - Disable : Not used ESL function
  - Enable (always) : The password is required whenever the operator starts engine.
- **Interval** : The password is required when the operator starts engine first. But the operator can restart the engine within the interval time without inputting the password.
  - The interval time can be set maximum 4 hours.

※ Default password : 00000 + hou

※ Password length : (5~10 digit) + hou

- **Smart key** (premium type, opt) : Smart key is registered when equipped with optional smart key. If smart key is not inside of the cabin, authentication process fails and the password entering is needed.

#### Password change

- The password is 5~10 digits.



Enter the current password



Enter the new password again



Enter the new password

#### ④ Machine Information

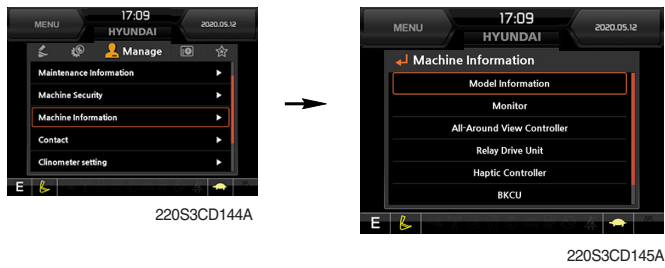

- This can confirm the identification of the model information (ECU), MCU, monitor, switch controller, RMCU, relay driver unit, AAVM (opt).

#### ⑤ Contact (A/S phone number)



Enter the new A/S phone number

#### ⑥ Service menu



- Power shift (standard/option) : Power shift pressure can be set by option menu.
- Operating hours : Operating hours since the machine line out can be checked by this menu.
- Breaker mode pump acting (1 pump/2 pump)
- EPPR current level (attach flow EPPR 1 & 2)
- Overload pressure : 100 ~ 350 bar

#### ⑦ Clinometer

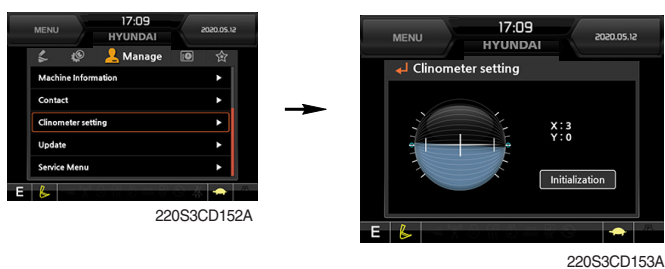

- When the machine is on the flatland, if tap the "initialization", the values of X, Y reset "0".
- You can confirm tilt of machine in cluster's operating screen.

### ⑧ Update (cluster & ETC devices)

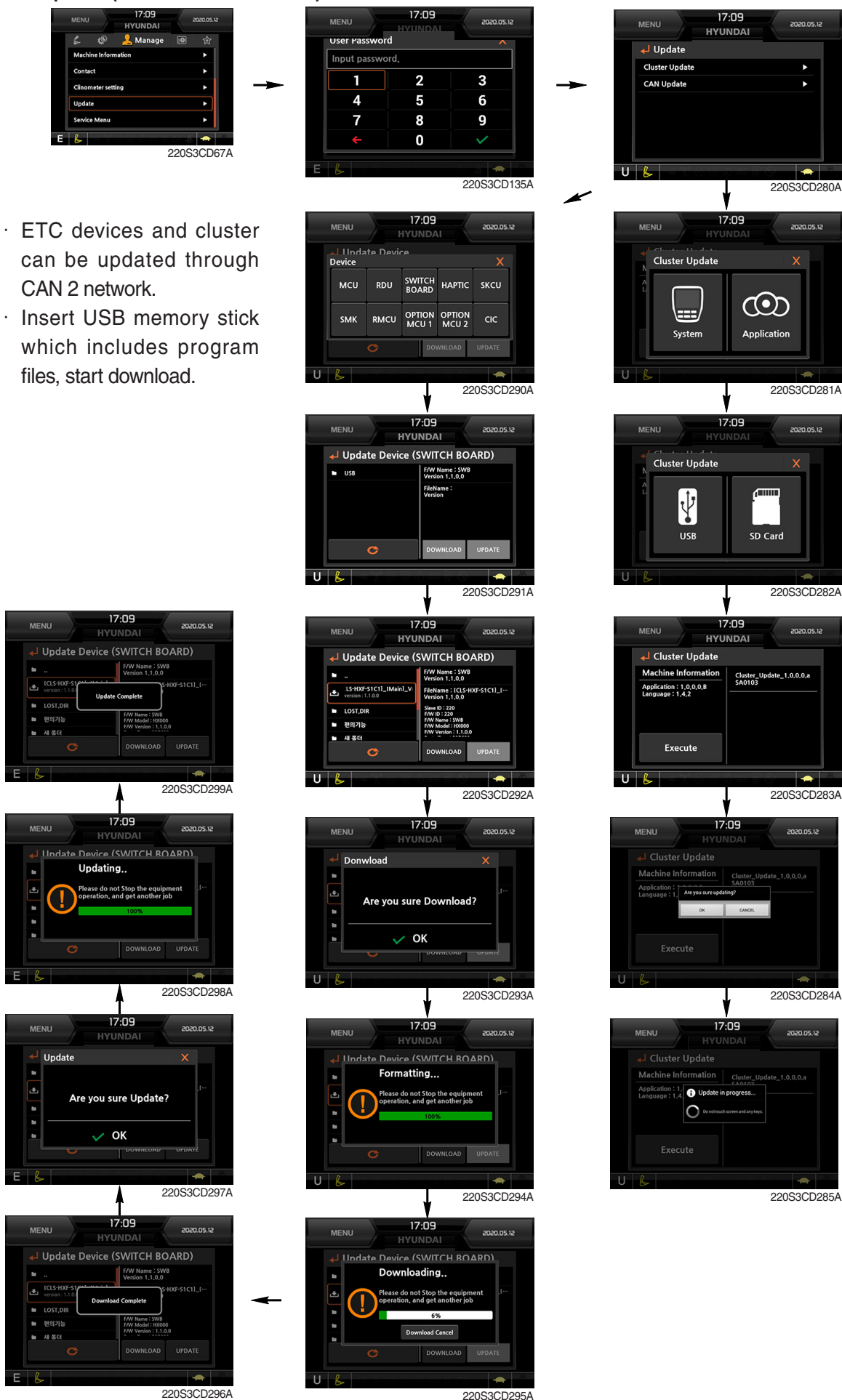

- ETC devices and cluster can be updated through CAN 2 network.
- Insert USB memory stick which includes program files, start download.

## (5) Display

### ① Display item



220S3CD154A



220S3CD155A



220S3CD156A

- The center display type of the LCD can be selected by this menu.
- The engine speed or each of the tripmeter (A,B,C) is displayed on the center display.

### ② Clock



220S3CD157A

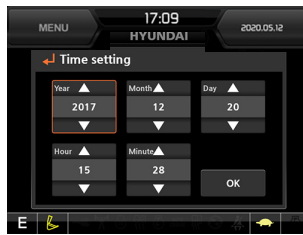

220S3CD158A

- The first line's three spots "\*\*/\*\*/\*\*\*\*" represent Year/Month/Day each.
- The second line shows the current time. (0:00~23:59)

### ③ Brightness



220S3CD159A



220S3CD160A

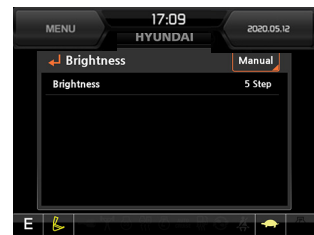

220S3CD139A



220S3CD141A



220S3CD191A

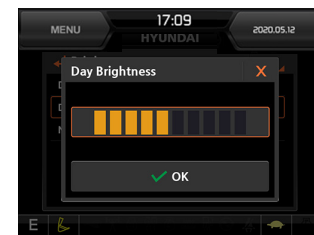

220S3CD192A

- If "Auto" is chosen, brightness for day and night can be differently set up. Also by using the bar in lower side, users can define which time interval belongs to day and night. (in bar figure, white area represents night time while orange shows day time)



#### ④ Unit

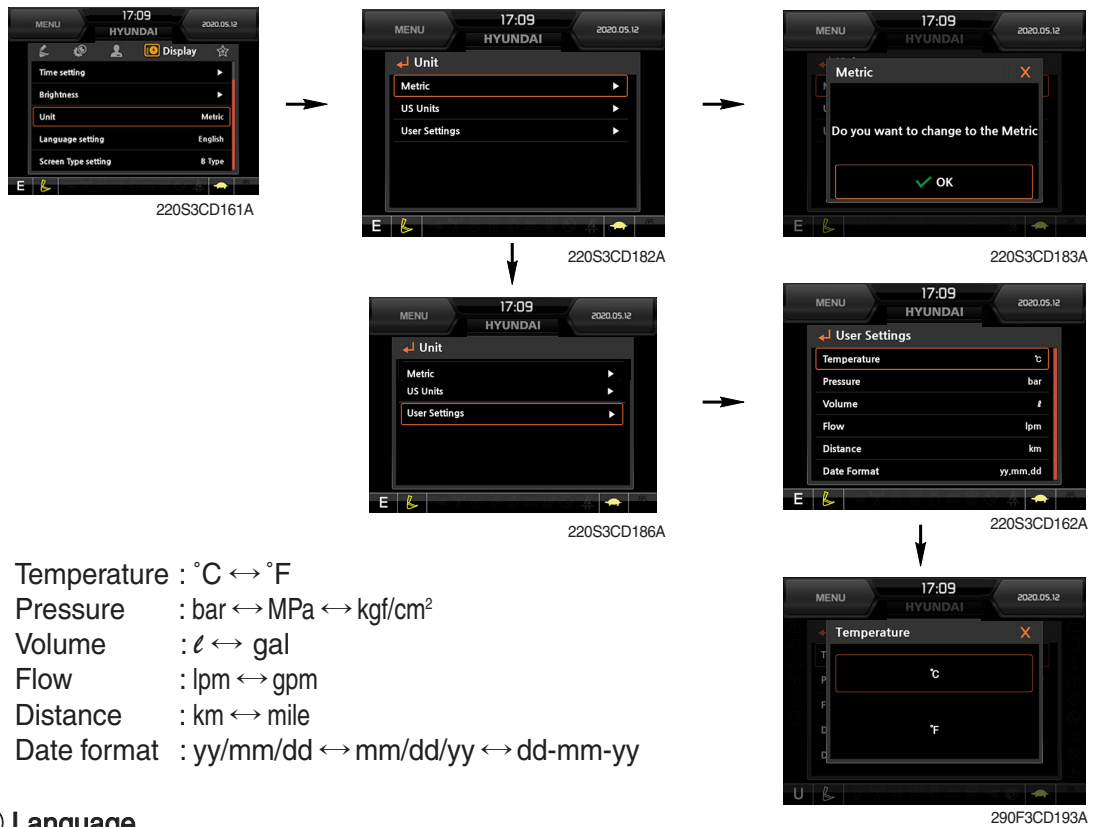

- Temperature : °C ↔ °F
- Pressure : bar ↔ MPa ↔ kgf/cm<sup>2</sup>
- Volume : ℓ ↔ gal
- Flow : lpm ↔ gpm
- Distance : km ↔ mile
- Date format : yy/mm/dd ↔ mm/dd/yy ↔ dd-mm-yy

#### ⑤ Language



- User can select preferable language and all displays are changed the selected language.

## ⑥ Screen type (premium type)



220S3CD165A

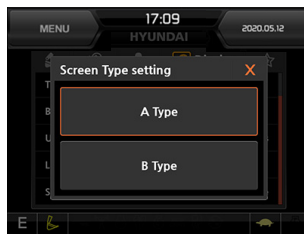

A Type (Default) 220S3CD166A



220S3CD156A



B Type (Option) 220S3CD174A



220S3CD167A

## (6) Utilities

### ① Tripmeter



220S3CD168A



220S3CD169A

- Maximum 3 kinds of tripmeters can be used at the same time.
- Each tripmeter can be turned on by choosing "Start" while it also can be turned off by choosing "Stop".
- If the tripmeter icon is activated in the operation screen, it can be controlled directly there.

### ② Camera setting

- If the rear camera is not installed on the machine, set disable.
- If the rear camera installed on the machine, set enable.



220S3CD225A



220S3CD255A

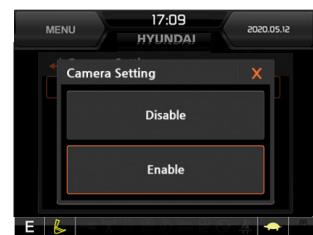

220S3CD256A

- In the operation screen, rear camera screen show up when ESC/CAM button is pushed.



220S3CD222A



290F3CD221

④ **AAVM** (All Around View Monitoring, premium type, opt)

- The AAVM buttons of the cluster consist of ESC/CAM and AUTO IDLE/Buzzer stop.



220S3CD244A

- **Escape button**

- It will enter into the AAVM mode from the beginning screen if the AAVM is installed.
- While in the AAVM mode, select the ESC button to return to the beginning screen.



220S3CD156A

The beginning screen

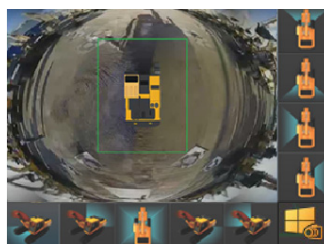

AAVM mode

235SA3CD222A

- **Buzzer stop button**

- In AAVM mode, it detects surrounding pedestrians or objects and the warning buzzer sounds.
- User can turn OFF the warning sound by pressing buzzer stop button.



290F3CD246A

- When the worker or pedestrian go to the green line (radius 5 m), an external danger area of equipping on the cluster screen, the warning buzzer sounds and it displays the blue rectangular box for the recognition of the worker and pedestrian. At this time, the operator should stop work immediately, and stop the buzzer by pressing the buzzer stop button. And then, please work after you check whether the danger factors are solved.



290F3CD247A

- When the worker or pedestrian go inside of red line (radius 3 m), an internal danger area of equipping on the cluster screen, the warning buzzer sounds and it displays the red rectangular box for the recognition of the worker and pedestrian. At this time, the operator should stop work immediately, and stop the buzzer by pressing the buzzer stop button. And then, please work after you check whether the danger factors are solved.

※ In AAVM mode, a touch screen of the LCD is available only. The multimodal dial of the haptic controller is not available.

# GROUP 16 FUEL WARMER SYSTEM

## 1. SPECIFICATION

- 1) Operating voltage :  $24 \pm 4$  V
- 2) Power :  $350 \pm 50$  W
- 3) Current : 15 A

## 2. OPERATION

- 1) The current of fuel warmer system is automatically controlled without thermostat according to fuel temperature.
  - 2) At the first state, the 15 A current flows to the fuel warmer and engine may be started in 1~2 minutes.
  - 3) If the fuel starts to flow, ceramic-disk in the fuel warmer heater senses the fuel temperature to reduce the current as low as 1.5 A.
- So, fuel is protected from overheating by this mechanism.

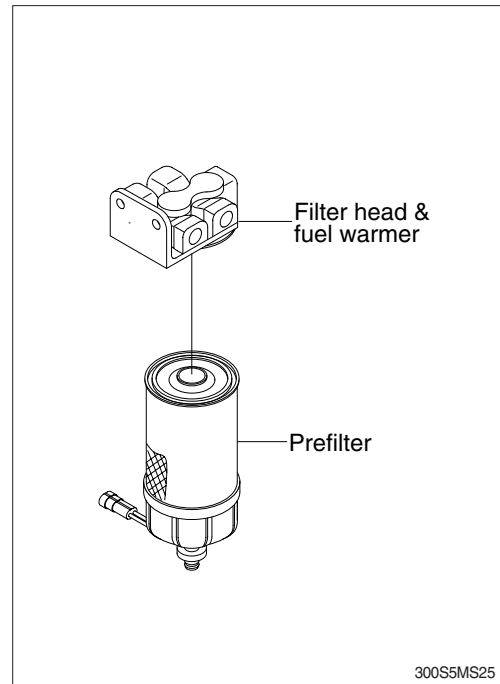

## 3. ELECTRIC CIRCUIT

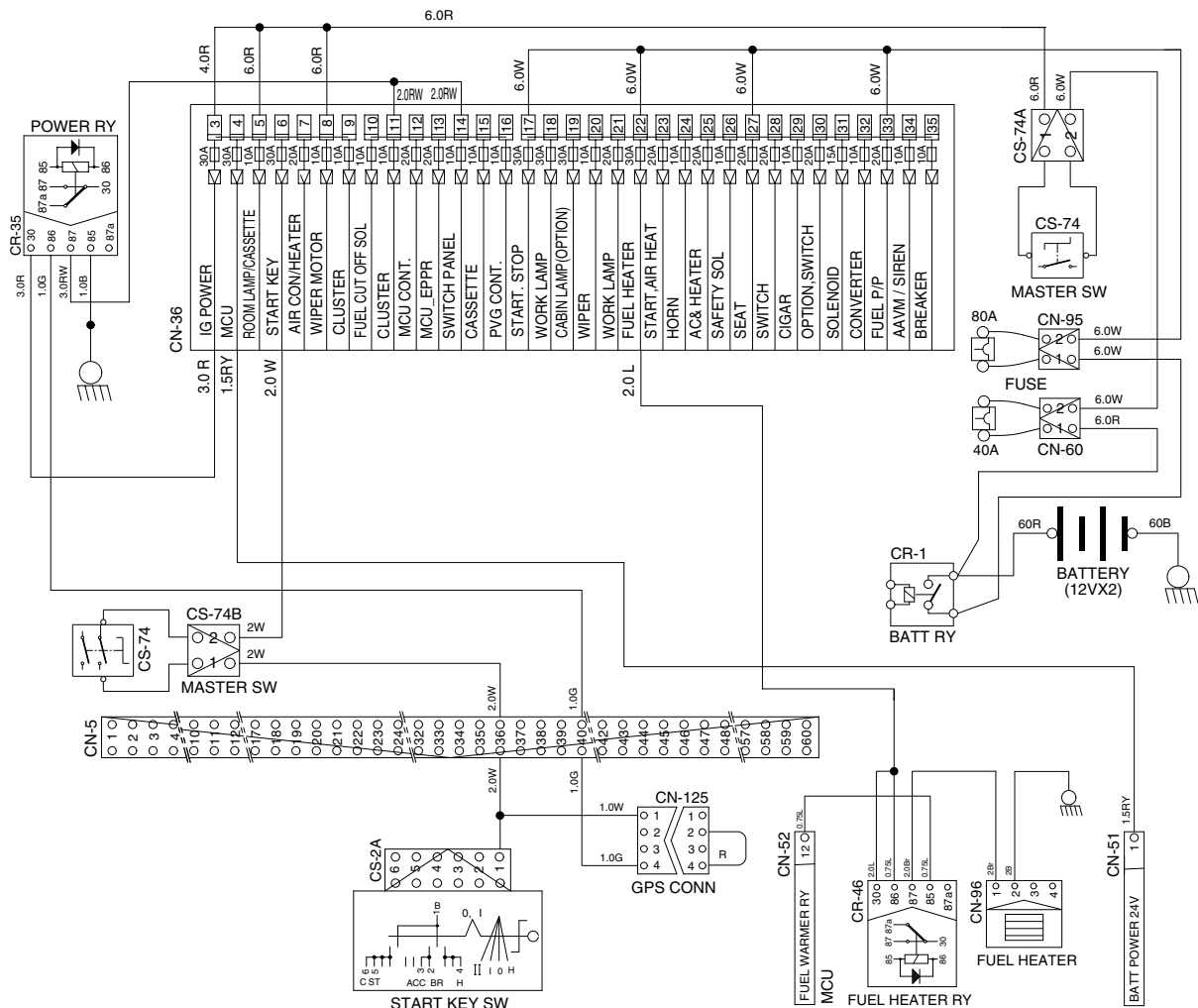

300S5MS26