

SECTION 5 MECHATRONICS SYSTEM

Group 1 Outline	5-1
Group 2 Mode Selection System	5-3
Group 3 Automatic Deceleration System	5-6
Group 4 Power Boost System	5-7
Group 5 Travel Speed Control System	5-8
Group 6 Automatic Warming Up System	5-9
Group 7 Engine Overheat Prevention System	5-10
Group 8 Variable Power Control System	5-11
Group 9 Attachment Flow Control System	5-12
Group 10 Boom Floating Control System.....	5-13
Group 11 Intelligent Power Control System.....	5-14
Group 12 Anti-Restart System	5-16
Group 13 Self-Diagnostic System	5-17
Group 14 Engine Control System	5-53
Group 15 EPPR Valve	5-54
Group 16 Monitoring System	5-59
Group 17 Fuel Warmer System	5-96

SECTION 5 MECHATRONICS SYSTEM

GROUP 1 OUTLINE

The ADVANCED CAPO (Computer Aided Power Optimization) system controls engine and pump mutual power at an optimum and less fuel consuming state for the selected work by mode selection, auto-deceleration, power boost function, etc. It monitors machine conditions, for instance, engine speed, coolant temperature, hydraulic oil temperature, and hydraulic oil pressure, etc. It consists of two MCU, a cluster, an ECM, EPPR valves, and other components. The MCU and the cluster protect themselves from over-current and high voltage input, and diagnose malfunctions caused by short or open circuit in electric system, and display error codes on the cluster.

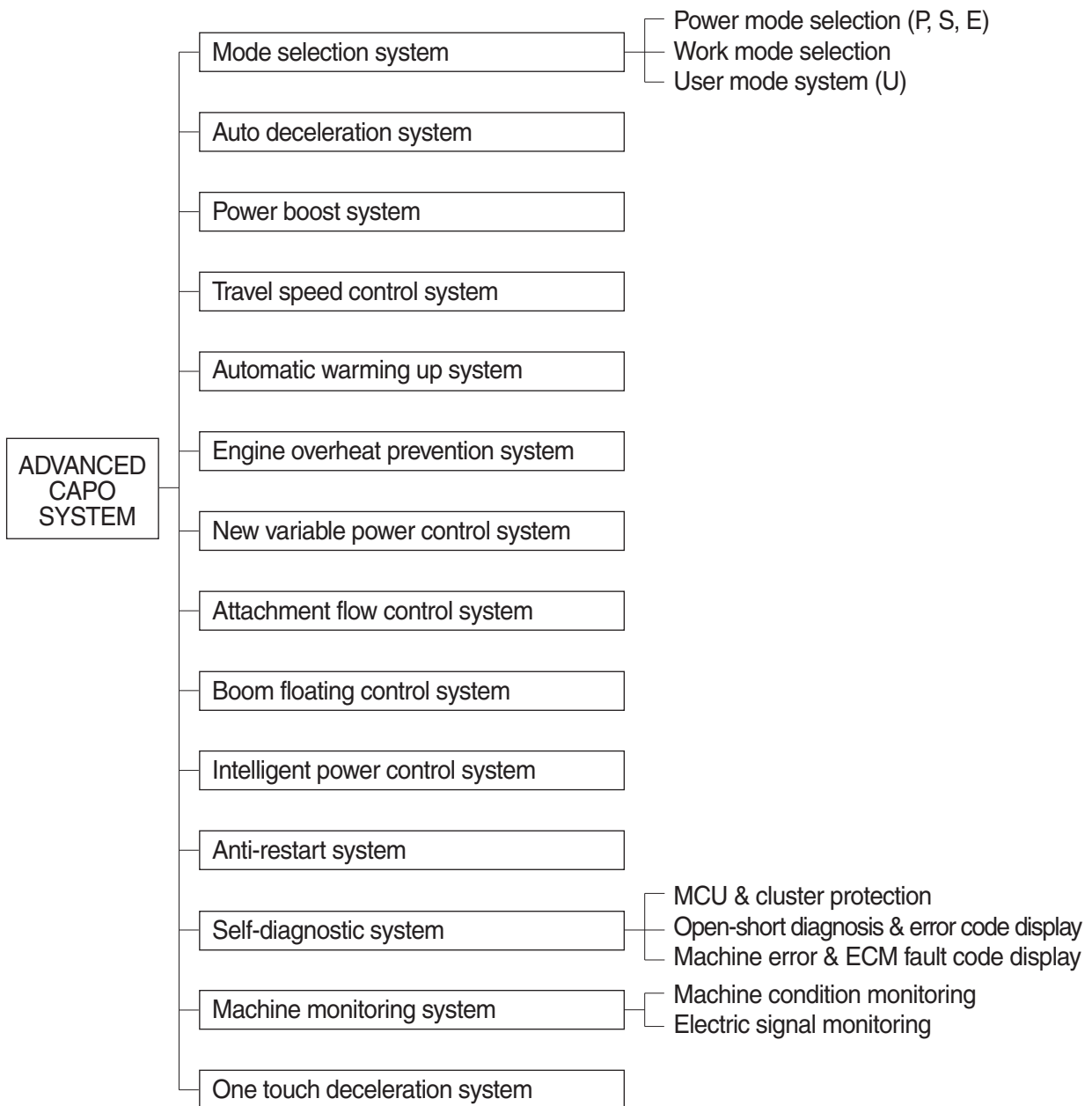

SYSTEM DIAGRAM

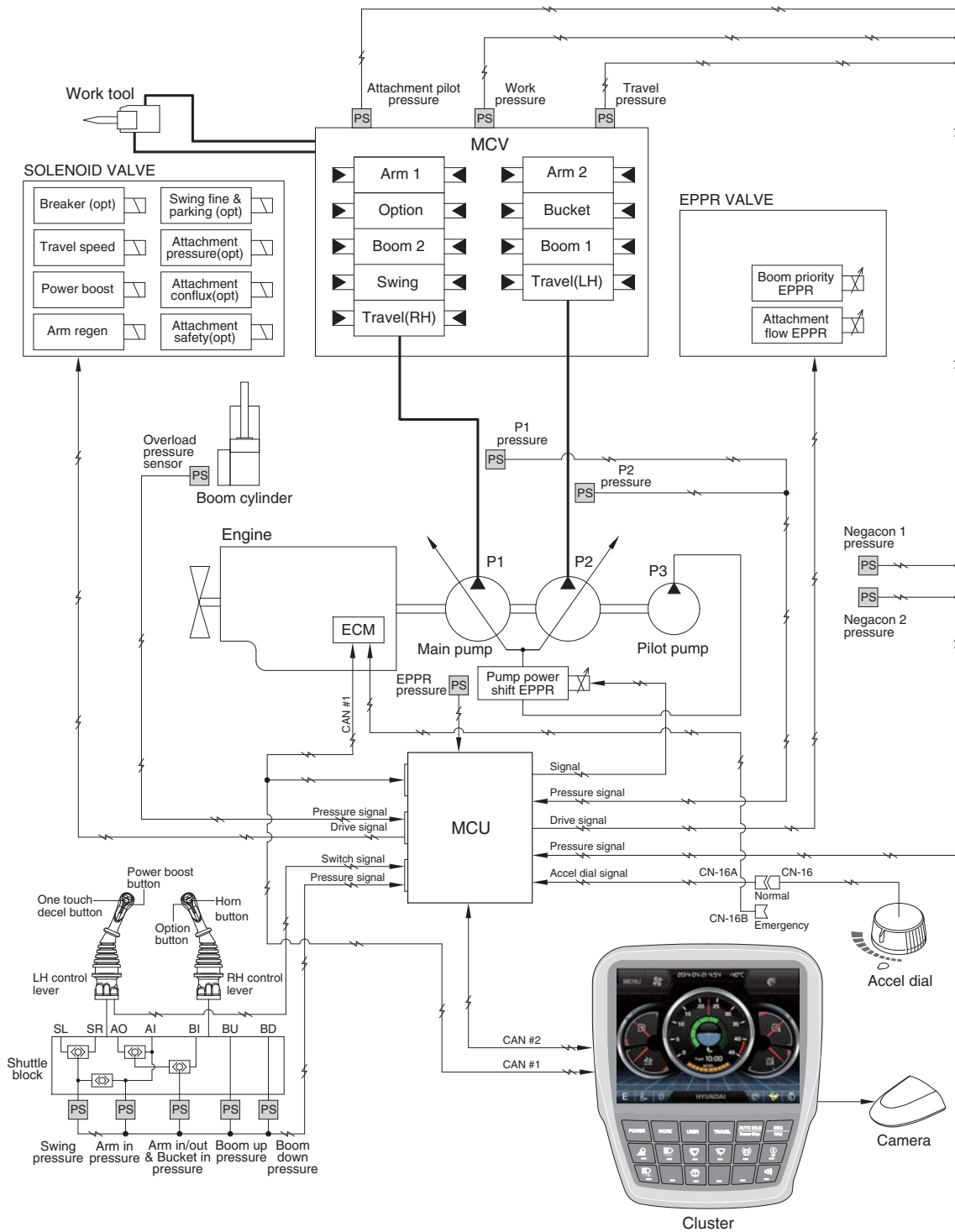

235ZF5MS01

GROUP 2 MODE SELECTION SYSTEM

1. POWER MODE SELECTION SYSTEM

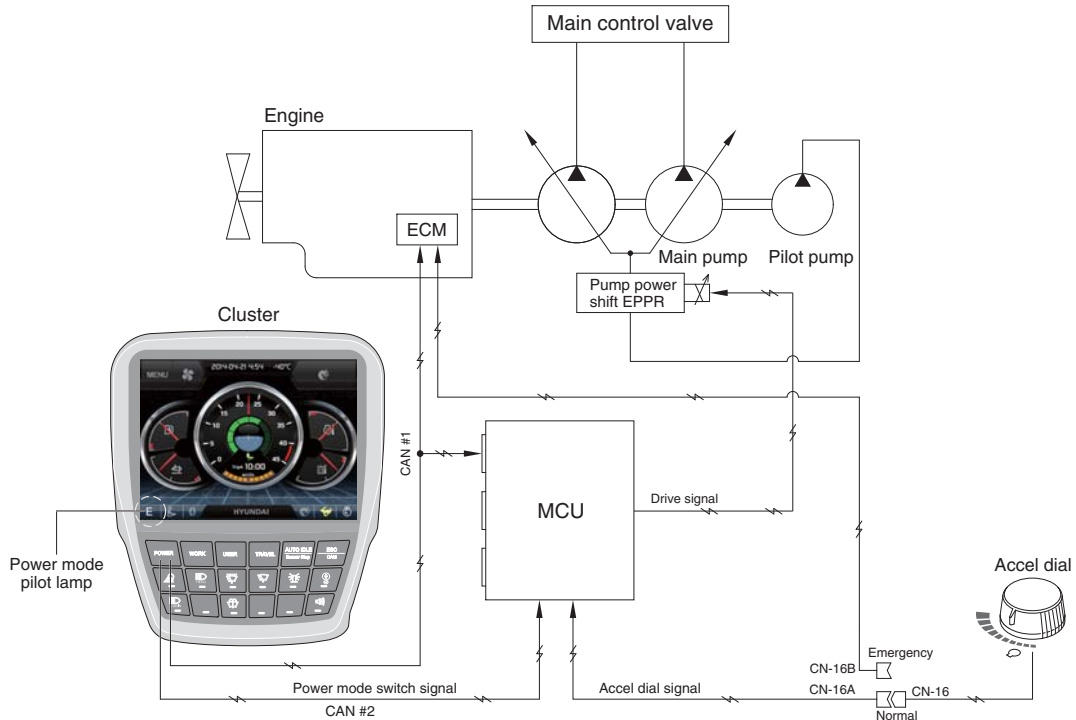

235ZF5MS02

Mode selection system (micro computer based electro-hydraulic pump and engine mutual control system) optimizes the engine and pump performance.

The combination of 3 power modes (P, S, E) and accel dial position (10 set) makes it possible to use the engine and pump power more effectively corresponding to the work conditions from a heavy and great power requesting work to a light and precise work.

Power mode	Application	Engine rpm				Power shift by EPPR valve			
		Standard		Option		Standard		Option	
		Unload	Load	Unload	Load	Current (mA)	Pressure (kgf/cm ²)	Current (mA)	Pressure (kgf/cm ²)
P	Heavy duty power	1800 ± 50	1950 ± 50	1900 ± 50	2000 ± 50	290 ± 30	8 (~3)	290 ± 30	8 (~3)
S	Standard power	1700 ± 50	1850 ± 50	1800 ± 50	1900 ± 50	360 ± 30	12 (~7) ± 3	330 ± 30	10 (~5) ± 3
E	Economy operation	1600 ± 50	1750 ± 50	1700 ± 50	1800 ± 50	360 ± 30	12 (~7) ± 3	360 ± 30	12 (~7) ± 3
AUTO DECEL	Engine deceleration	1000 ± 100	-	1000 ± 100	-	700 ± 30	38 ± 3	700 ± 30	38 ± 3
One touch decel	Engine quick deceleration	850 ± 100	-	850 ± 100	-	700 ± 30	38 ± 3	700 ± 30	38 ± 3
KEY START	Key switch start position	850 ± 100	-	850 ± 100	-	700 ± 30	38 ± 3	700 ± 30	38 ± 3

※ Power shift (Standard/Option) can be changed by "Service menu" in "Management" on the cluster.

※ (~*) : Load

2. WORK MODE SELECTION SYSTEM

Work mode consists of the general operation (bucket) and the optional attachment (breaker, crusher).

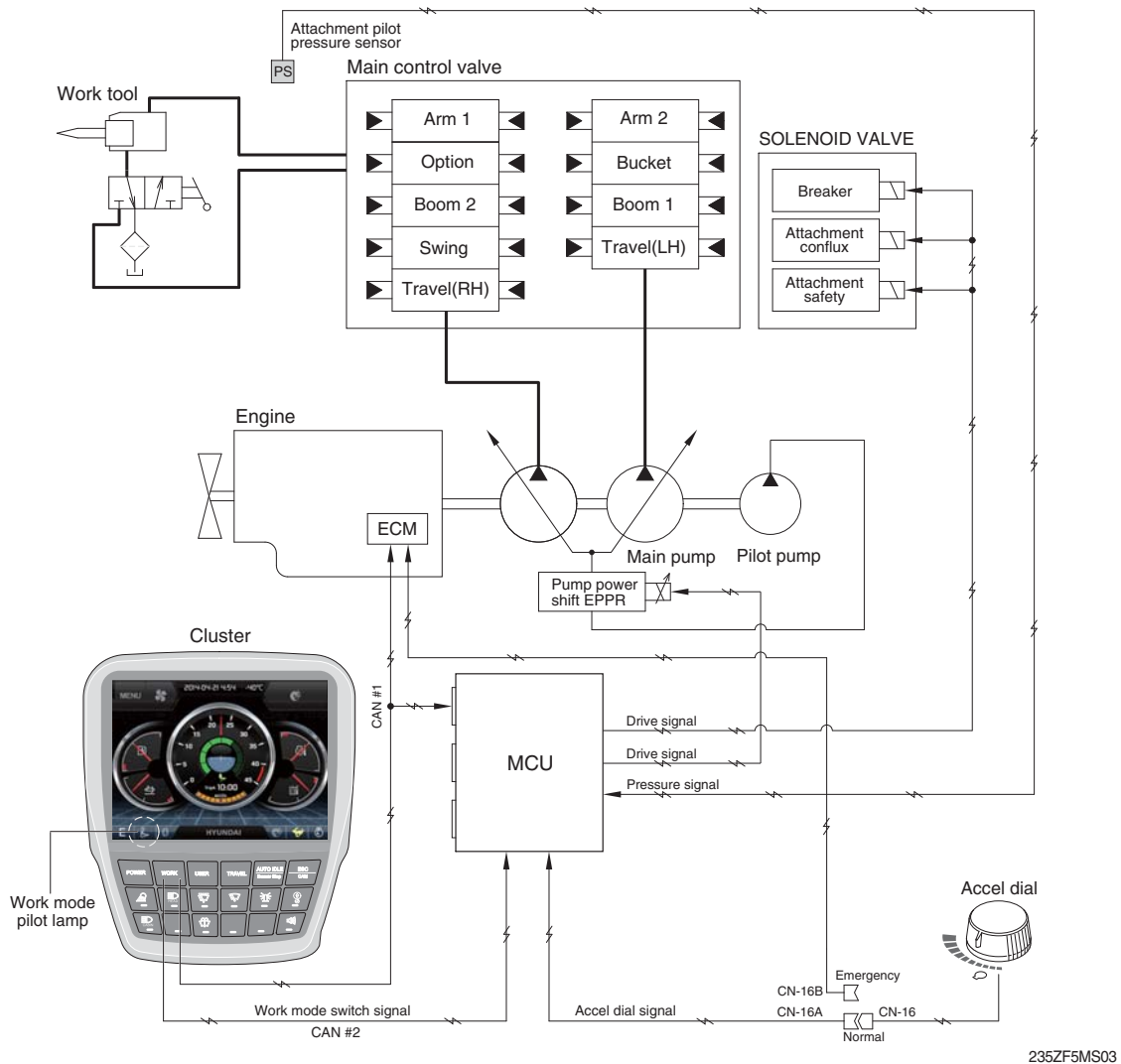

1) GENERAL WORK MODE (bucket)

This mode is used to general digging work.

2) ATT WORK MODE (breaker, crusher)

It controls the pump flow and system pressure according to the operation of breaker or crusher.

Description	General mode	Work tool	
	Bucket	Breaker	Crusher
Attachment safety solenoid	OFF	-	ON
Attachment conflux solenoid	OFF	ON/OFF	ON/OFF
Attachment flow EPPR current	100 mA	100~700 mA	100~700 mA
Breaker solenoid*	OFF	ON	-

★ When breaker operating button is pushed.

3. USER MODE SELECTION SYSTEM

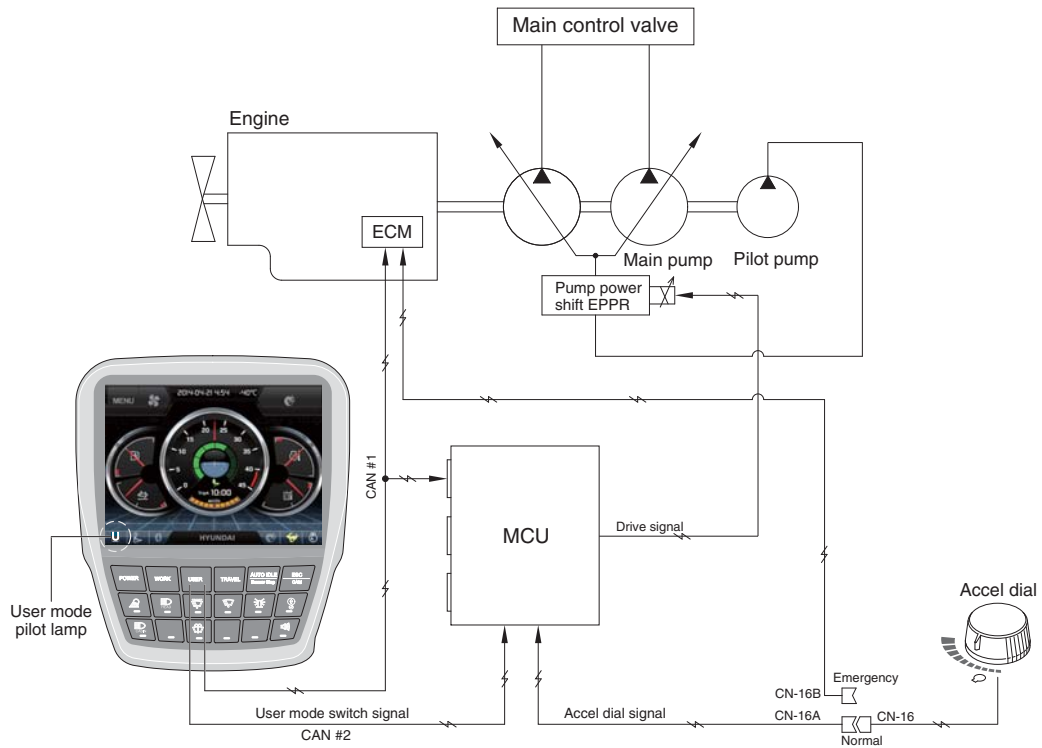

235ZF5MS04

1) High idle rpm, auto idle rpm and EPPR pressure can be adjusted and memorized in the U-mode.

2) LCD segment vs parameter setting

Step ()	Engine speed (rpm)	Idle speed (rpm)	Power shift (bar)
1	1300	750	0
2	1400	800	3
3	1500	850	6
4	1600	900	9
5	1700	950	12
6	1800	1000 (auto decel)	16
7	1850	1050	20
8	1900	1100	26
9	1950	1150	32
10	2000	1200	38

GROUP 3 AUTOMATIC DECELERATION SYSTEM

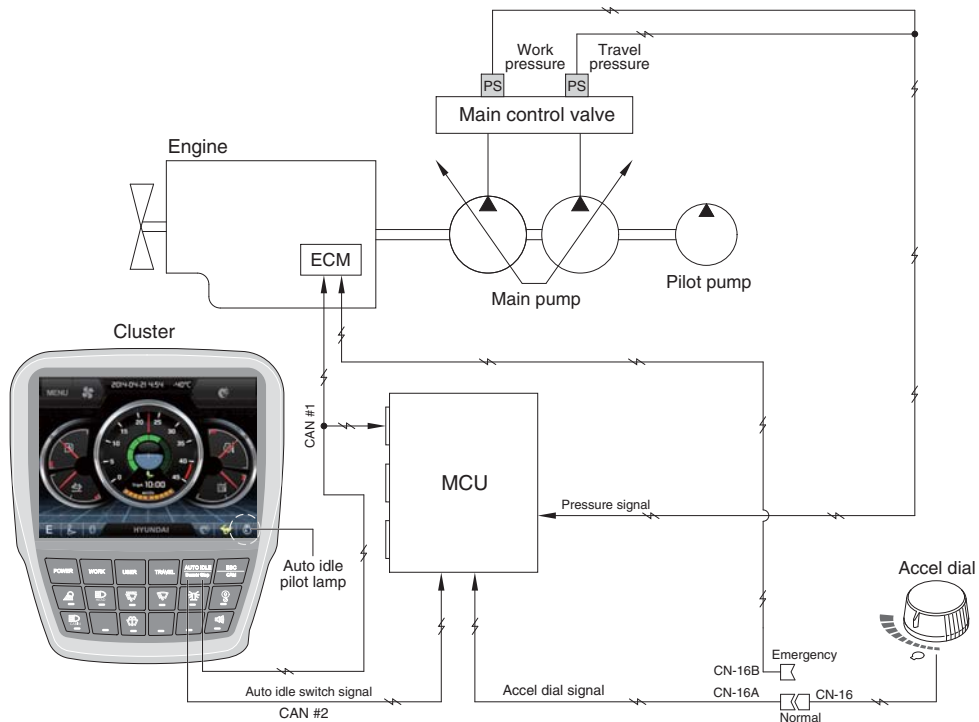

235ZF5MS05

1. WHEN AUTO IDLE PILOT LAMP ON

When all of the work equipment control levers including swing and travel levers are at neutral for 4 seconds, MCU sends throttle command to ECM to reduce the engine speed to 1000 rpm. If the control levers are at neutral for 1 minute, MCU reduces the engine speed to 850 rpm. As the result of reducing the engine speed, fuel consumption and noise are effectively cut down during non-operation of the control levers.

When the Auto idle pilot lamp is turned off by pressing the switch or any control lever is operated, the reduced engine speed rises upto the speed before deceleration in a second.

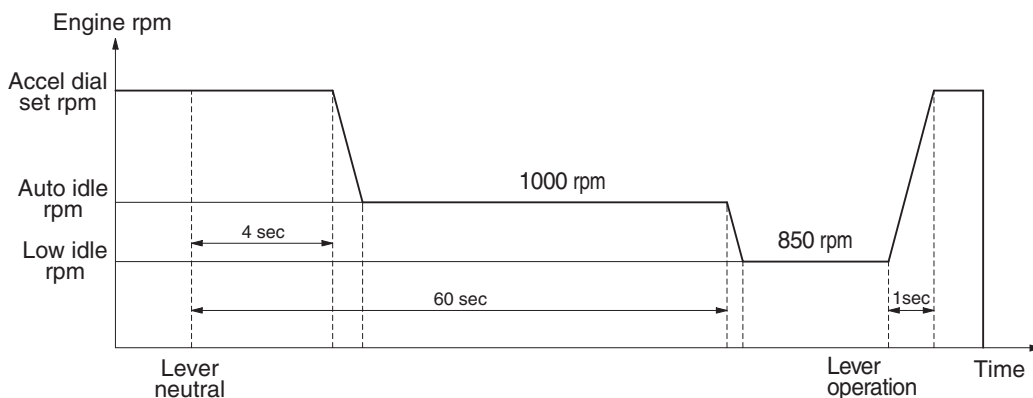

21095MS05

2. WHEN AUTO IDLE PILOT LAMP OFF

The engine speed can be set as desired using the accel dial switch, and even if the control levers are neutral, the engine speed is not reduced.

※ Auto idle function can be activated when accel dial position is over 4.

GROUP 4 POWER BOOST SYSTEM

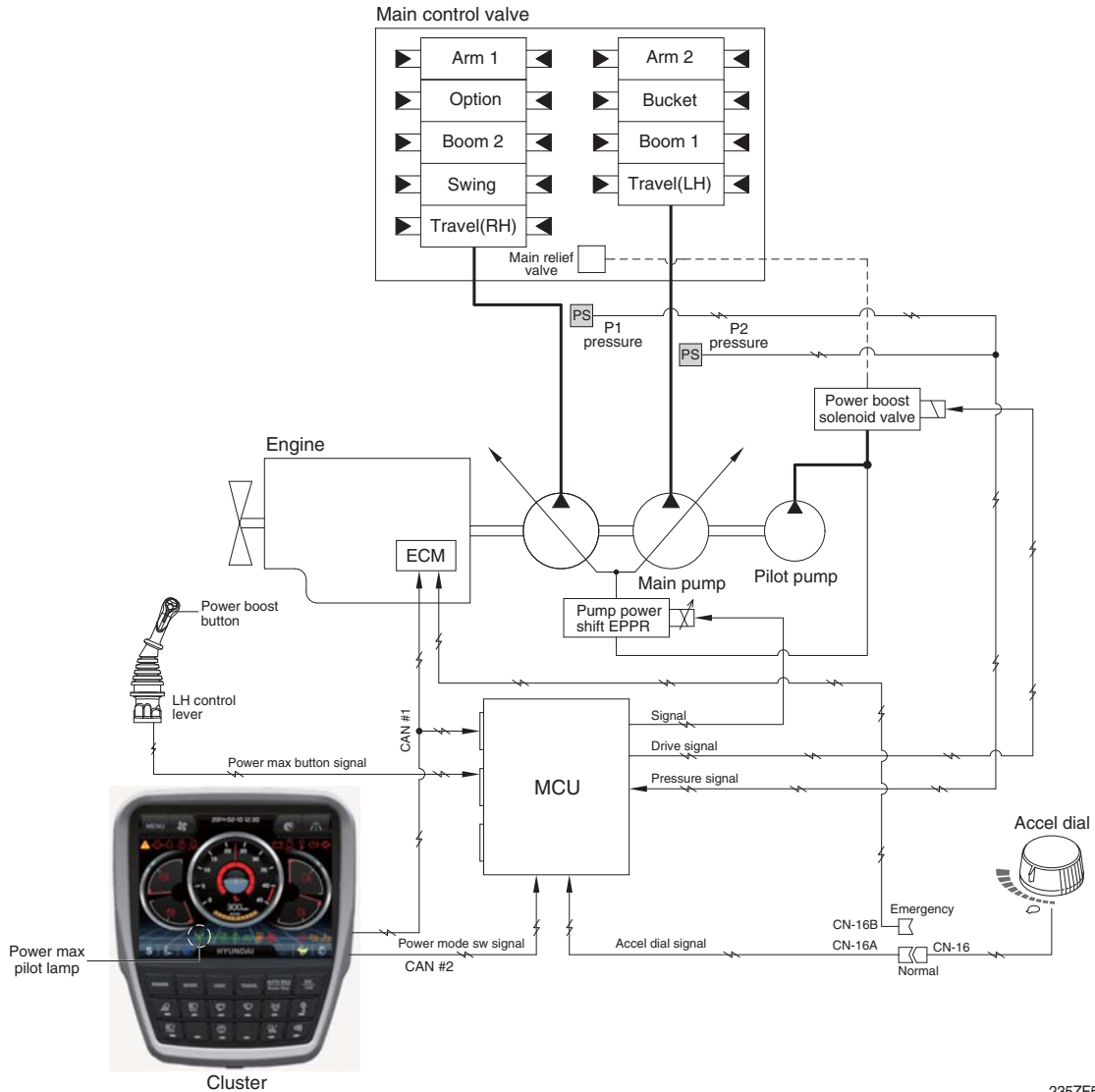

- When the power boost switch on the left control lever knob is pushed ON, the power mode is set P mode and maximum digging power is increased by 10 %.
- When the power boost function is activated, the power boost solenoid valve pilot pressure raises the set pressure of the main relief valve to increase the digging power.

Description	Condition	Function
Activated	Power boost switch : ON Accel dial : over 8	- Power mode : P - Accel dial power : 9 - Power boost solenoid : ON - Power boost pilot lamp : ON - Operating time : max 8 seconds
Canceled	Power boost switch : OFF	- Pre-set power mode - Power boost solenoid : OFF - Power boost pilot lamp : OFF

※ When the auto power boost is set to Enable and power mode is set to P mode on the cluster, the digging power is automatically increased as working conditions by the MCU. It is operated max 8 seconds.

GROUP 5 TRAVEL SPEED CONTROL SYSTEM

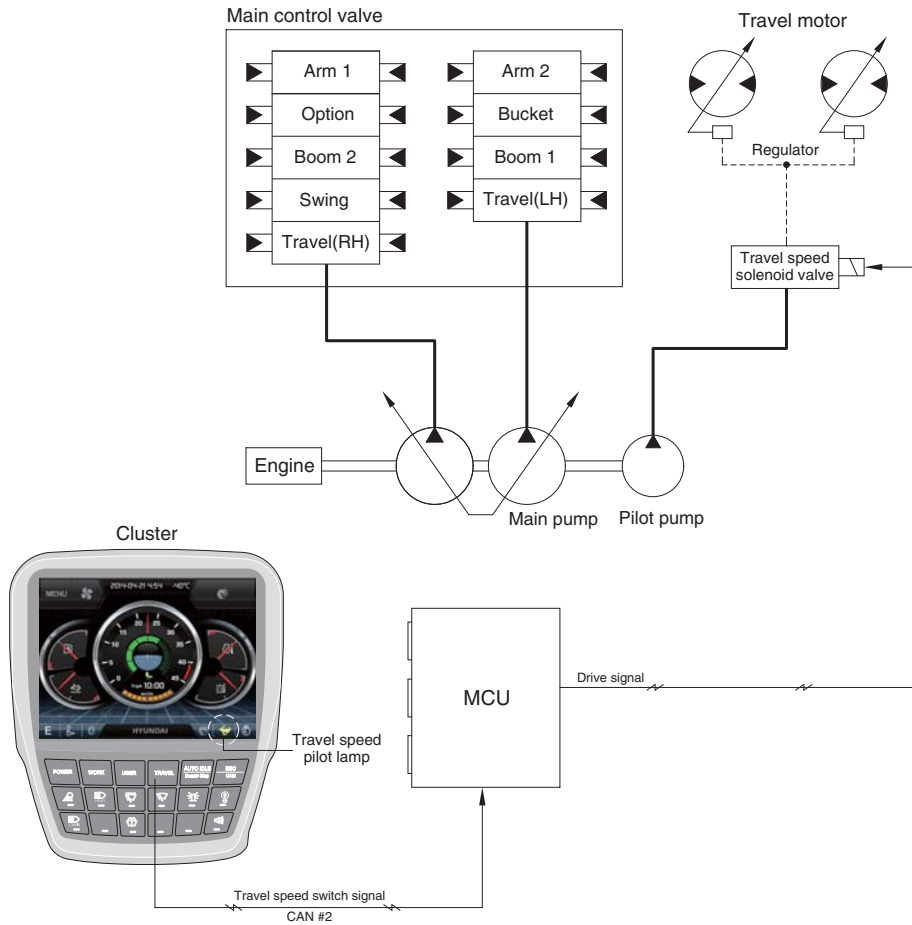

260L5MS07

Travel speed can be switched manually by pressing the travel speed switch on the cluster.

Speed	Travel speed solenoid valve	Lamp on cluster	Operation
Low	OFF	Turtle	Low speed, high driving torque in the travel motor
High	ON	Rabbit	High speed, low driving torque in the travel motor

※ Default : Turtle (Low)

GROUP 6 AUTOMATIC WARMING UP SYSTEM

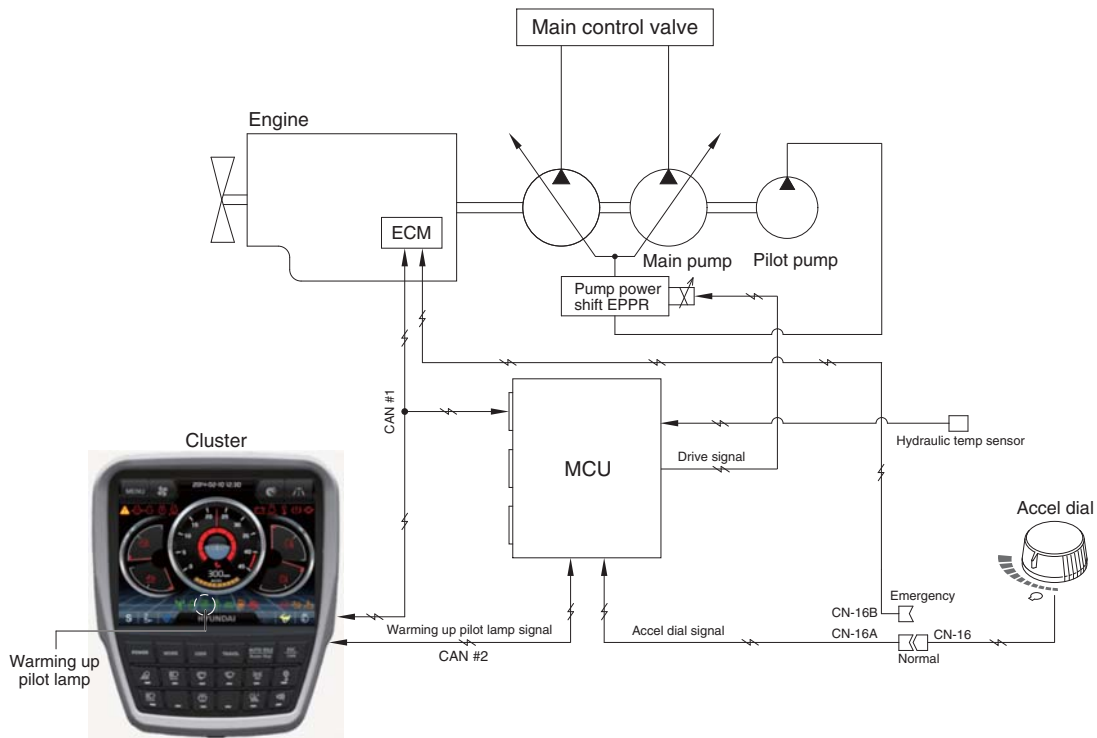

235ZF5MS08

1. The MCU receives the engine coolant temperature from the ECM, and if the coolant temperature is below 30°C, it increases the engine speed from key start rpm to 1000 rpm. At this time the mode does not change. If the coolant temperature sensor has fault, the hydraulic oil temperature signal is substituted.
2. In case of the coolant temperature increases up to 30°C, the engine speed is decreased to key start speed. And if an operator changes power mode set during the warming up function, the MCU cancels the automatic warming up function.

3. LOGIC TABLE

Description	Condition	Function
Actuated	- Coolant temperature : below 30°C(after engine run)	- Power mode : Default (E mode) - Warming up time : 10 minutes (max) - Warming up pilot lamp : ON
Canceled	- Coolant temperature : Above 30°C - Warming up time : Above 10 minutes - Changed power mode set by operator - RCV lever or pedal operating - Auto idle cancel ※ If any of the above conditions is applicable, the automatic warming up function is canceled	- Power mode : set mode - Warming up pilot lamp : OFF

GROUP 7 ENGINE OVERHEAT PREVENTION SYSTEM

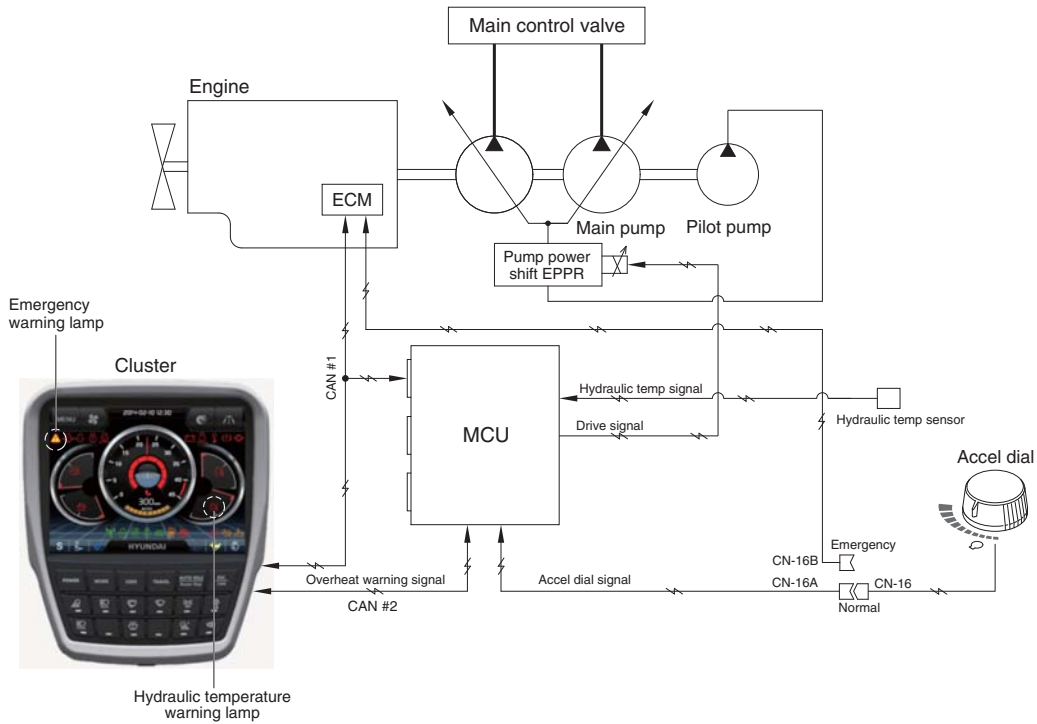

1. If the engine coolant temperature or the hydraulic oil temperature is overheated over 100°C, the warning lamp is ON and the pump input torque or the engine speed is reduced as below logic table.

2. LOGIC TABLE

Description		Condition	Function
First step warning	Activated	- Coolant temperature : Above 103°C - Hydraulic oil temperature : Above 100°C	- Warning lamp pops up and buzzer sounds - Pump input torque is reduced.
	Canceled	- Coolant temperature : Less than 100°C - Hydraulic oil temperature : Less than 95°C	- Return to pre-set the pump absorption torque.
Second step warning	Activated	- Coolant temperature : Above 107°C - Hydraulic oil temperature : Above 105°C	- Emergency warning lamp pops up on the center of LCD and the buzzer sounds. - Engine speed is reduced after 10 seconds.
	Canceled	- Coolant temperature : Less than 103°C - Hydraulic oil temperature : Less than 100°C	- Return to pre-set the engine speed. - Hold pump absorption torque on the first step warning.

GROUP 8 NEW VARIABLE POWER CONTROL SYSTEM

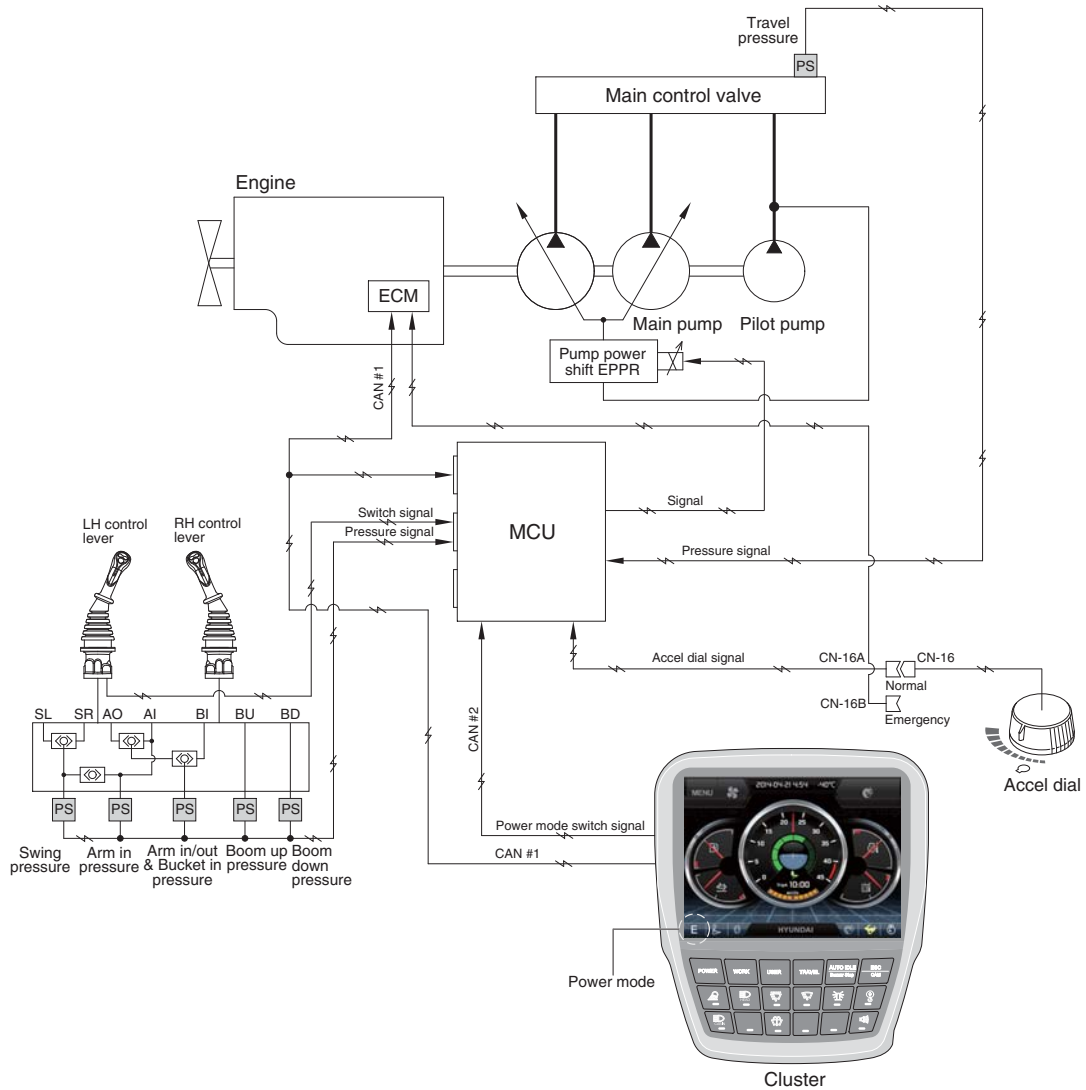

235ZF5MS10

- The variable power control system makes constantly exact pump control through improvement variable engine rpm control and response and optimization of control input sensor signal. It makes fuel saving.

Description	Function	
	Stand by	Working
Engine speed	- 100~150 rpm lower than working	- Set rpm
Pump EPPR	- 13 bar	- 8 bar
Pump flow	- Lower than working	- Normal pump flow

※ The variable power control function can be activated at all of the power mode.

GROUP 9 ATTACHMENT FLOW CONTROL SYSTEM

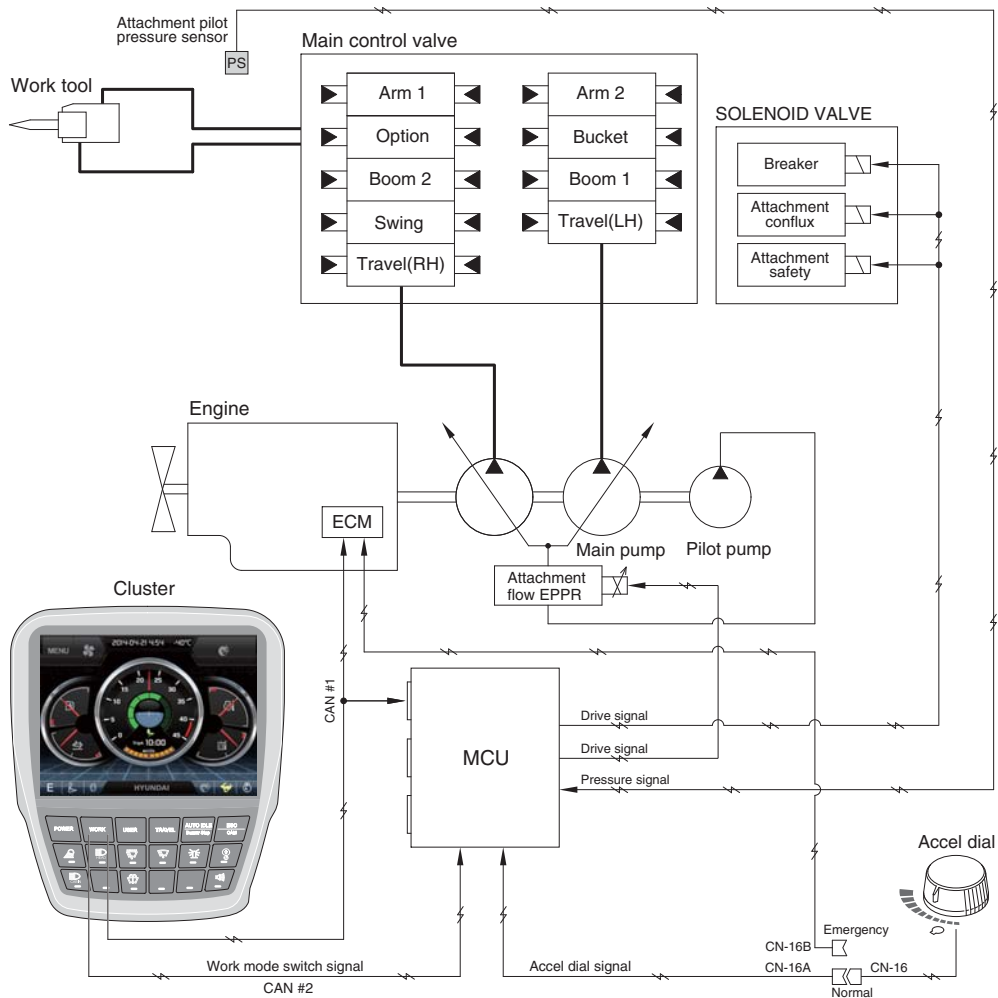

235ZF5MS11

- The system is used to control the pump delivery flow according to set of the work tool on the cluster by the attachment flow EPPR valve.

Description	Work tool	
	Breaker	Crusher
Flow level	100 ~ 180 lpm	100 ~ 440 lpm
Attach safety solenoid	-	ON
Attach conflux solenoid	ON/OFF	ON/OFF
Breaker solenoid★	ON	-

※ Refer to the page 5-79 for the attachment kinds and max flow.

★ When breaker operating button is pushed.

GROUP 10 BOOM FLOATING CONTROL SYSTEM

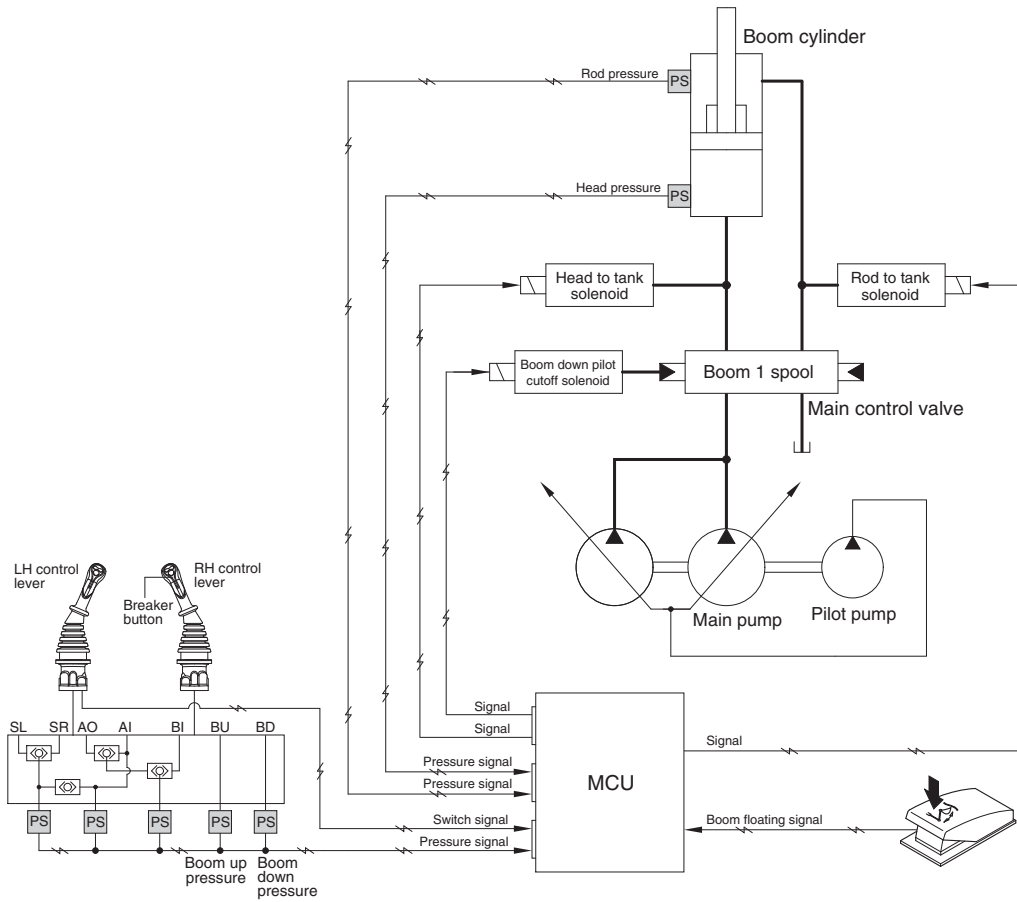

- Boom floating automatically controls boom cylinder along the ground by operating arm cylinder only.

Description		Condition	Function
Work mode ^{★1}	Floating mode		
General mode	Boom up floating ^{★2}	Floating mode sw : ON	Rod to tank solenoid : ON Head to tank solenoid : OFF Boom down cutoff solenoid : OFF
	Boom up/down floating ^{★2}	Floating mode sw : ON Breaker button : Pressed Boom down pilot pressure > 25 bar Boom up pilot pressure < 5 bar	Rod to tank solenoid : ON Head to tank solenoid : ON Boom down cutoff solenoid : ON
Breaker mode	Boom down floating	Floating mode sw : ON Breaker button : Pressed Boom down pilot pressure > 25 bar Boom up pilot pressure < 5 bar	Rod to tank solenoid : OFF Head to tank solenoid : ON Boom down cutoff solenoid : ON
Temporarily canceled		During operation of boom floating Boost sw : Pressed	Rod to tank solenoid : OFF Head to tank solenoid : OFF Boom down cutoff solenoid : OFF

★1 Boom floating is not activated when work mode is crusher mode.

★2 These functions are activated just in case the excavator is not in jack up status.

GROUP 11 INTELLIGENT POWER CONTROL SYSTEM

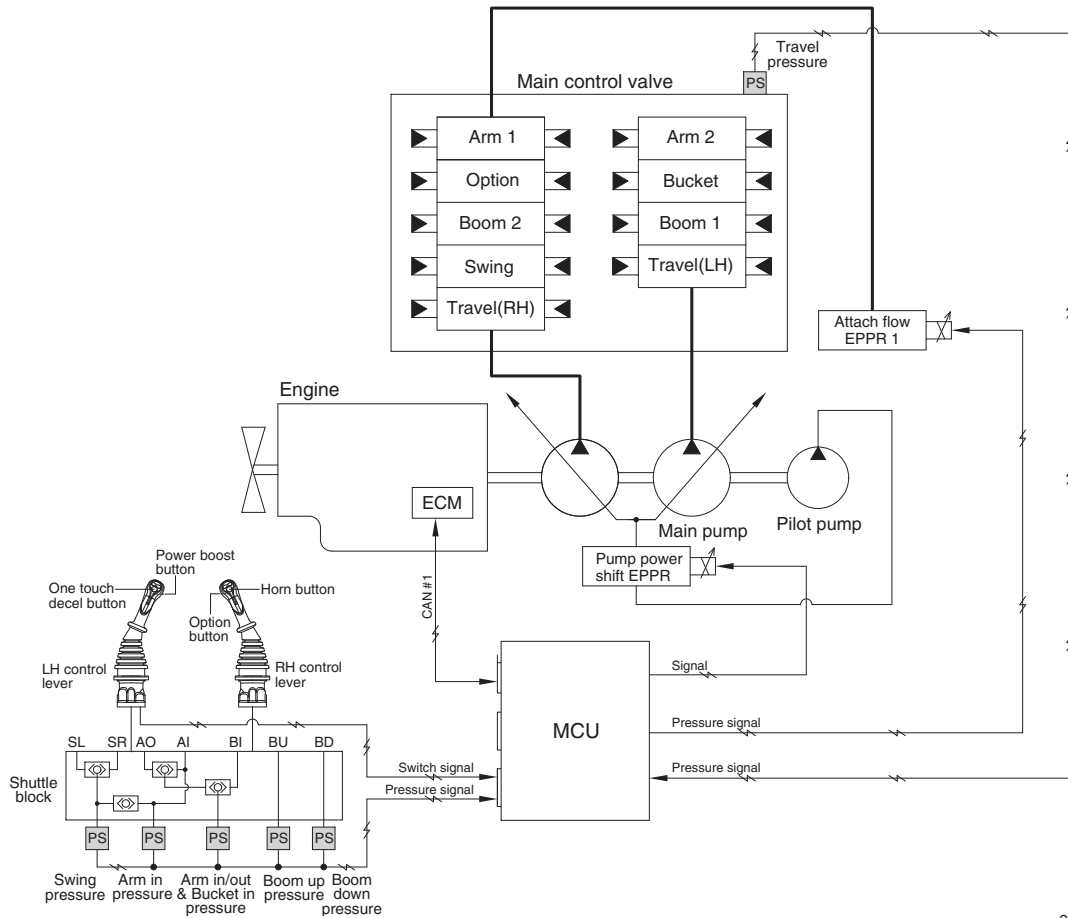

260L5MS18

1. When the requirement of pump flow rate is low, IPC mode controls pump flow rate to improve fuel efficiency.

Condition*1	Function
IPC mode : ON*2 Boom up Arm in Not travel motion Not swing motion	Limitation of pump flow rate : Activated
None of upper condition	Limitation of pump flow rate : Canceled

*1 AND condition

*2 IPC mode ON/OFF is selected at "Mode setup > IPC mode". See next page.

2. IPC MODE SELECTION

IPC mode ON/OFF and the levels of flow rate limit can be selected at "Mode setup > IPC mode"

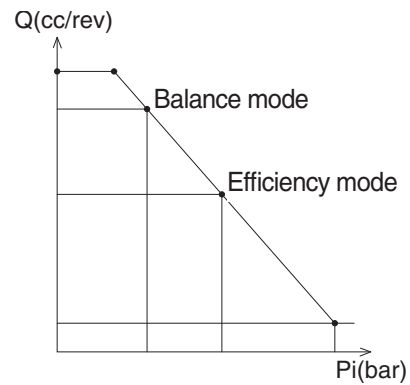

290F3CD311

IPC mode	Description
Balance mode (default)	IPC mode ON, limit level 1
Efficiency mode	IPC mode ON, limit level 2
Speed mode	IPC mode OFF

GROUP 12 ANTI-RESTART SYSTEM

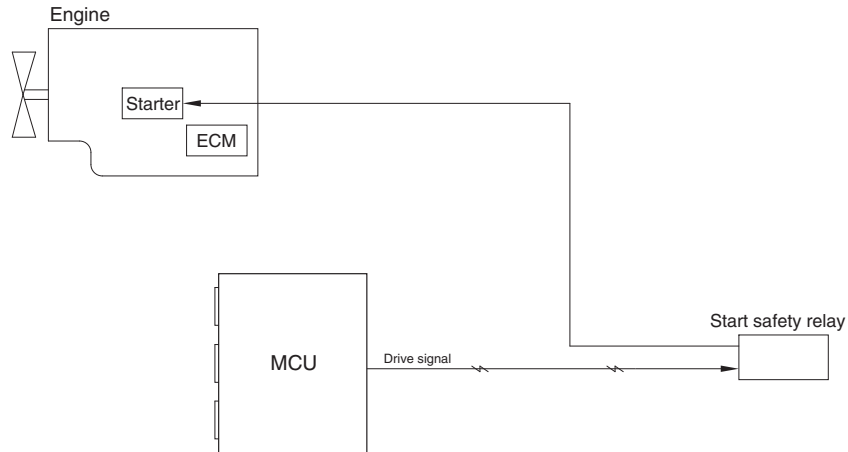

300L5MS12

1. ANTI-RESTART FUNCTION

After a few seconds from the engine starts to run, MCU turns off the start safety relay to protect the starter from inadvertent restarting.

GROUP 13 SELF-DIAGNOSTIC SYSTEM

1. OUTLINE

When any abnormality occurs in the ADVANCED CAPO system caused by electric parts malfunction and by open or short circuit, the MCU diagnoses the problem and sends the error codes to the cluster and also stores them in the memory.

2. MONITORING

1) Active fault



- The active faults of the MCU or engine ECM can be checked by this menu.

2) Logged fault



- The logged faults of the MCU or engine ECM can be checked by this menu.

3) Delete logged fault



- The logged faults of the MCU or engine ECM can be deleted by this menu.

3. MACHINE ERROR CODES TABLE

DTC		Diagnostic Criteria	Application		
HCESPN	FMI		G	C	W
101	3	10 seconds continuous, Hydraulic Oil Temp. Measurement Voltage > 3.8V	●		
	4	10 seconds continuous, Hydraulic Oil Temp. Measurement Voltage < 0.3V	●		
	(Results / Symptoms) 1. Monitor – Hydraulic oil temperature display failure 2. Control Function – Fan revolutions control failure (Checking list) 1. CD-1 (#2), CN-52 (#24) Checking Open/Short 2. CD-1 (#1), CN-51 (#5) Checking Open/Short				
105	0	10 seconds continuous, Working Press. Sensor Measurement Voltage > 5.2V	●		
	1	10 seconds continuous, $0.3V \leq$ Working Press. Sensor Measurement Voltage < 0.8V	●		
	4	10 seconds continuous, Working Press. Sensor Measurement Voltage < 0.3V	●		
(Results / Symptoms) 1. Monitor – Working Press. display failure 2. Control Function – Auto Idle operation failure, Engine variable horse power control operation failure (Checking list) 1. CD-7 (#B) – CN-52 (#37) Checking Open/Short 2. CD-7 (#A) – CN-51 (#3) Checking Open/Short 3. CD-7 (#C) – CN-51 (#13) Checking Open/Short					
108	0	10 seconds continuous, Travel Oil Press. Sensor Measurement Voltage > 5.2V		●	
	1	10 seconds continuous, $0.3V \leq$ Travel Oil Press. Sensor Measurement Voltage < 0.8V	●		
	4	10 seconds continuous, Travel Oil Press. Sensor Measurement Voltage < 0.3V	●		
(Results / Symptoms) 1. Monitor – Travel Oil Press. display failure 2. Control Function – Auto Idle operation failure, Engine variable horse power control operation failure, IPC operation failure, Driving alarm operation failure (Checking list) 1. CD-6 (#B) – CN-52 (#38) Checking Open/Short 2. CD-6 (#A) – CN-51 (#3) Checking Open/Short 3. CD-6 (#C) – CN-51 (#13) Checking Open/Short					

※ Some error codes are not applied to this machine.

G : General

C : Crawler Type

W : Wheel Type

DTC		Diagnostic Criteria	Application		
HCESPN	FMI		G	C	W
120	0	10 seconds continuous, Main Pump 1 (P1) Press. Sensor Measurement Voltage > 5.2V	●		
	1	10 seconds continuous, $0.3V \leq$ Main Pump 1 (P1) Press. Sensor Measurement Voltage < 0.8V	●		
	4	10 seconds continuous, Main Pump 1 (P1) Press. Sensor Measurement Voltage < 0.3V	●		
	(Results / Symptoms) 1. Monitor – Main Pump 1 (P1) Press. display failure 2. Control Function – Automatic voltage increase operation failure, Overload at compensation control failure (Checking list) 1. CD-42 (#B) – CN-52 (#29) Checking Open/Short 2. CD-42 (#A) – CN-51 (#3) Checking Open/Short 3. CD-42 (#C) – CN-51 (#13) Checking Open/Short				
121	0	10 seconds continuous, Main Pump 2 (P2) Press. Sensor Measurement Voltage > 5.2V	●		
	1	10 seconds continuous, $0.3V \leq$ Main Pump 2 (P2) Press. Sensor Measurement Voltage < 0.8V	●		
	4	10 seconds continuous, Main Pump 2 (P2) Press. Sensor Measurement Voltage < 0.3V	●		
	(Results / Symptoms) 1. Monitor – Main Pump 2 (P2) Press. display failure 2. Control Function – Automatic voltage increase operation failure, Overload at compensation control failure (Checking list) 1. CD-43 (#B) – CN-52 (#12) Checking Open/Short 2. CD-43 (#A) – CN-51 (#3) Checking Open/Short 3. CD-43 (#C) – CN-51 (#13) Checking Open/Short				
122	1	(when you had conditions mounting pressure sensor) 10 seconds continuous, $0.3V \leq$ Overload Press. Sensor Measurement Voltage < 0.8V	●		
	4	(when you had conditions mounting pressure sensor) 10 seconds continuous, Overload Press. Sensor Measurement Voltage < 0.3V	●		
	(Results / Symptoms) 1. Monitor – Overload Press. display failure 2. Control Function – Overload warning alarm failure (Checking list) 1. CD-31 (#B) – CN-52 (#16) Checking Open/Short 2. CD-31 (#A) – CN-51 (#3) Checking Open/Short 3. CD-31 (#C) – CN-51 (#13) Checking Open/Short				

※ Some error codes are not applied to this machine.

G : General

C : Crawler Type

W : Wheel Type

DTC		Diagnostic Criteria	Application		
HCESPN	FMI		G	C	W
123	0	10 seconds continuous, Negative 1 Press. Sensor Measurement Voltage > 5.2V	●		
	1	10 seconds continuous, 0.3V ≤ Negative 1 Press. Sensor Measurement Voltage < 0.8V	●		
	4	10 seconds continuous, Negative 1 Press. Sensor Measurement Voltage < 0.3V	●		
	(Results / Symptoms) 1. Monitor – Negative 1 Press. display failure 2. Control Function – IPC operation failure, Option attachment flow control operation failure (Checking list) 1. CD-70 (#B) – CN-52 (#33) Checking Open/Short 2. CD-70 (#A) – CN-51 (#3) Checking Open/Short 3. CD-70 (#C) – CN-51 (#13) Checking Open/Short				
124	0	10 seconds continuous, Negative 2 Press. Sensor Measurement Voltage > 5.2V	●		
	1	10 seconds continuous, 0.3V ≤ Negative 2 Press. Sensor Measurement Voltage < 0.8V	●		
	4	10 seconds continuous, Negative 2 Press. Sensor Measurement Voltage < 0.3V	●		
	(Results / Symptoms) 1. Monitor – Negative 2 Press. display failure 2. Control Function – Option attachment flow control operation failure (Checking list) 1. CD-71 (#B) – CN-52 (#17) Checking Open/Short 2. CD-71 (#A) – CN-51 (#3) Checking Open/Short 3. CD-71 (#C) – CN-51 (#13) Checking Open/Short				
127	0	10 seconds continuous, Boom Up Pilot Press. Sensor Measurement Voltage > 5.2V	●		
	1	10 seconds continuous, 0.3V ≤ Boom Up Pilot Press. Sensor Measurement Voltage < 0.8V	●		
	4	10 seconds continuous, Boom Up Pilot Press. Sensor Measurement < 0.3V	●		
	(Results / Symptoms) 1. Monitor – Boom Up Pilot Press. display failure 2. Control Function – Engine/Pump variable horse power control operation failure, IPC operation failure, Boom first operation failure (Checking list) 1. CD-32 (#B) – CN-52 (#19) Checking Open/Short 2. CD-32 (#A) – CN-51 (#3) Checking Open/Short 3. CD-32 (#C) – CN-5 1(#13) Checking Open/Short				

※ Some error codes are not applied to this machine.

G : General

C : Crawler Type

W : Wheel Type

DTC		Diagnostic Criteria	Application		
HCESPN	FMI		G	C	W
128	0	(when you had conditions mounting pressure sensor) 10 seconds continuous, Boom Down Pilot Press. Sensor Measurement Voltage > 5.2V	●		
	1	(when you had conditions mounting pressure sensor) 10 seconds continuous, 0.3V ≤ Boom Down Pilot Press. Sensor Measurement Voltage < 0.8V	●		
	4	(when you had conditions mounting pressure sensor) 10 seconds continuous, Boom Down Pilot Press. Sensor Measurement Voltage < 0.3V	●		
	(Results / Symptoms) 1. Monitor – Boom Down Pilot Press. display failure 2. Control Function – Boom floating operation failure (Checking list) 1. CD-85 (#B) – CN-53 (#23) Checking Open/Short 2. CD-85 (#A) – CN-53 (#3) Checking Open/Short 3. CD-85 (#C) – CN-53 (#13) Checking Open/Short				
129	0	10 seconds continuous, Arm In Pilot Press. Sensor Measurement Voltage > 4.8V	●		
	1	10 seconds continuous, 0.3V ≤ Arm In Pilot Press. Sensor Measurement Voltage < 0.8V	●		
	4	10 seconds continuous, Arm In Pilot Press. Sensor Measurement Voltage < 0.3V	●		
	(Results / Symptoms) 1. Monitor – Arm In Pilot Press. display failure 2. Control Function – IPC operation failure (Checking list) 1. CD-90 (#B) – CN-52 (#28) Checking Open/Short 2. CD-90 (#A) – CN-51 (#3) Checking Open/Short 3. CD-90 (#C) – CN-51 (#13) Checking Open/Short				
133	0	10 seconds continuous, Arm In/Out & Bucket In Pilot Press. Sensor Measurement Voltage > 5.2V	●		
	1	10 seconds continuous, 0.3V ≤ Arm In/Out & Bucket In Pilot Press. Sensor Measurement Voltage < 0.8V	●		
	4	10 seconds continuous, Arm In/Out & Bucket In Pilot Press. Sensor Measurement Voltage < 0.3V	●		
	(Results / Symptoms) 1. Monitor – Arm In/Out & Bucket In Pilot Press. display failure 2. Control Function – Engine variable horse power control operation failure (Checking list) 1. CD-35 (#B) – CN-52 (#14) Checking Open/Short 2. CD-35 (#A) – CN-51 (#3) Checking Open/Short 3. CD-35 (#C) – CN-51 (#13) Checking Open/Short				

※ Some error codes are not applied to this machine.

G : General

C : Crawler Type

W : Wheel Type

DTC		Diagnostic Criteria	Application		
HCESPN	FMI		G	C	W
135	0	10 seconds continuous, Swing Pilot Press. Sensor Measurement Voltage > 5.2V	●		
	1	10 seconds continuous, 0.3V ≤ Swing Pilot Press. Sensor Measurement Voltage < 0.8V	●		
	4	10 seconds continuous, Swing Pilot Press. Sensor Measurement Voltage < 0.3V	●		
	(Results / Symptoms) 1. Monitor – Swing Pilot Press. display failure 2. Control Function – IPC operation, Boom first operation failure (Checking list) 1. CD-24 (#B) – CN-52 (#36) Checking Open/Short 2. CD-24 (#A) – CN-51 (#3) Checking Open/Short 3. CD-24 (#C) – CN-51 (#13) Checking Open/Short				
138	0	Monitor – Select Attachment(breaker / crusher) 10 seconds continuous, Attachment Pilot Press. Sensor Measurement Voltage > 5.2V	●		
	1	Monitor – Select Attachment(breaker / crusher) 10 seconds continuous, 0.3V ≤ Attachment Pilot Press. Sensor Measurement Voltage < 0.8V	●		
	4	Monitor – Select Attachment(breaker / crusher) 10 seconds continuous, Attachment Pilot Press. Sensor Measurement Voltage < 0.3V	●		
	(Results / Symptoms) 1. Monitor – Attachment Pilot Press. display failure 2. Control Function – Option attachment flow control operation failure (Checking list) 1. CD-69 (#B) – CN-53 (#14) Checking Open/Short 2. CD-69 (#A) – CN-53 (#3) Checking Open/Short 3. CD-69 (#C) – CN-53 (#13) Checking Open/Short				
139	1	10 seconds continuous, 0.3V ≤ Option Pilot Press. Sensor Measurement Voltage < 0.8V			●
	4	10 seconds continuous, Option Pilot Press. Sensor Measurement Voltage < 0.3V			●
	(Results / Symptoms) 1. Monitor – Option Pilot Press. display failure 2. Control Function – Auto Idle operation failure (Checking list) 1. CD-100 (#B) – CN-52 (#21) Checking Open/Short 2. CD-100 (#A) – CN-51 (#3) Checking Open/Short 3. CD-100 (#C) – CN-1 (#6) Checking Open/Short				

※ Some error codes are not applied to this machine.

G : General

C : Crawler Type

W : Wheel Type

DTC		Diagnostic Criteria	Application		
HCESPN	FMI		G	C	W
140	5	(Detection) (When Pump EPPR Current is more than 10 mA) 10 seconds continuous, Pump EPPR drive current < 0 mA (Cancellation) (When Pump EPPR Current is more than 10 mA) 3 seconds continuous, Pump EPPR drive current ≥ 10 mA	●		
	6	(Detection) 10 seconds continuous, Pump EPPR drive current > 1.0A (Cancellation) 3 seconds continuous, Pump EPPR drive current ≤ 1.0 A	●		
(Results / Symptoms) 1. Control Function – Pump horse power setting specification difference (Fuel efficiency/speed specification failure) (Checking list) 1. CN-75 (#2) – CN-52 (#9) Checking Open/Short 2. CN-75 (#1) – CN-52 (#10) Checking Open/Short					
141	5	(Model Parameter) mounting Boom Priority EPPR (Detection) (When Boom Priority EPPR Current is more than 10 mA) 10 seconds continuous, Boom Priority EPPR drive current < 0 mA (Cancellation) (When Boom Priority EPPR Current is more than 10 mA) 3 seconds continuous, Boom Priority EPPR drive current ≥ 10 mA	●		
	6	(Detection) 10 seconds continuous, Boom Priority EPPR drive current > 1.0 A (Cancellation) 3 seconds continuous, Boom Priority EPPR drive current ≤ 1.0 A	●		
(Results / Symptoms) 1. Control Function – Boom first control operation failure (Checking list) 1. CN-133 (#2) – CN-52 (#34) Checking Open/Short 2. CN-133 (#1) – CN-52 (#35) Checking Open/Short					

※ Some error codes are not applied to this machine.

G : General

C : Crawler Type

W : Wheel Type

DTC		Diagnostic Criteria	Application		
HCESPN	FMI		G	C	W
143	5	(Detection) (When Travel EPPR Current is more than 10 mA) 10 seconds continuous, Travel EPPR drive current = 0 mA (Cancellation) (When Travel EPPR Current is more than 100 mA) 3 seconds continuous, Travel EPPR drive current \geq 10 mA			●
	6	(Detection) 10 seconds continuous, Travel EPPR drive current > 1.0 A (Cancellation) 3 seconds continuous, Travel EPPR drive current \leq 1.0 A			●
	(Results / Symptoms) 1. Control Function – cruise control operation failure (Checking list) 1. CN-246 (#2) – CN-54 (#39) Checking Open/Short 2. CN-246 (#1) – CN-51 (#40) Checking Open/Short				
145	5	(Model Parameter) mounting Remote Cooling Fan EPPR (Detection) (When Remote Cooling Fan EPPR Current is more than 10 mA) 10 seconds continuous, Remote Cooling Fan EPPR drive current = 0 mA (Cancellation) (When Remote Cooling Fan EPPR Current is more than 10 mA) 3 seconds continuous, Remote Cooling Fan EPPR drive current \geq 10 mA	●		
	6	(Detection) 10 seconds continuous, Remote Cooling Fan EPPR drive current > 1.0 A (Cancellation) 3 seconds continuous, Remote Cooling Fan EPPR drive current \leq 1.0 A	●		
	(Results / Symptoms) 1. Control Function – Remote fan control operation failure (Checking list) 1. CD-52 (#1) – CN-51 (#9) Checking Open/Short 2. CD-52 (#2) – CN-51 (#14) Checking Open/Short				

※ Some error codes are not applied to this machine.

G : General

C : Crawler Type

W : Wheel Type

DTC		Diagnostic Criteria	Application		
HCESPN	FMI		G	C	W
164	4	(Detection) (When Working Cutoff Relay is Off) 10 seconds continuous, Working Cutoff Relay drive unit Measurement Voltage $\leq 3.0V$ (Cancellation) (When Working Cutoff Relay is Off) 3 seconds continuous, Working Cutoff Relay drive unit Measurement Voltage $> 3.0V$			●
	6	(Detection) (When Working Cutoff Relay is On) 10 seconds continuous, Working Cutoff Relay drive current $> 6.5 A$ (Cancellation) (When Working Cutoff Relay is On) 3 seconds continuous, Working Cutoff Relay drive current $\leq 6.5 A$			●
(Results / Symptoms) 1. Control Function – (Wheel Excavator) In driving mode, attachment hydraulic pilot pressure cut off failure (Checking list) 1. CR-47 (#85) – CN-54 (#9) Checking Open/Short 2. CR-47 (#30, #86) – CN-45 (#B+ term) Checking Open/Short					
166	4	(Detection) (When Power Max Solenoid is Off) 10 seconds continuous, Power Max Solenoid drive unit Measurement Voltage $\leq 3.0V$ (Cancellation) (When Power Max Solenoid is Off) 3 seconds continuous, Power Max Solenoid drive unit Measurement Voltage $> 3.0V$	●		
	6	(Detection) (When Power Max Solenoid is On) 5 seconds continuous, Power Max Solenoid drive current $> 4.5 A$ (Cancellation) (When Power Max Solenoid is On) 3 seconds continuous, Power Max Solenoid drive current $\leq 4.5 A$	●		
(Results / Symptoms) 1. Control Function – Voltage increase operation failure (Checking list) 1. CN-88 (#1) – CN-52 (#2) Checking Open/Short 2. CN-88 (#2) – CN-45 (#B+ term) Checking Open/Short					

※ Some error codes are not applied to this machine.

G : General

C : Crawler Type

W : Wheel Type

DTC		Diagnostic Criteria	Application		
HCESPN	FMI		G	C	W
167		(Detection) (When Travel Speed Solenoid is Off) 10 seconds continuous, Travel Speed Solenoid drive unit Measurement Voltage $\leq 3.0V$ (Cancellation) (When Travel Speed Solenoid is Off) 3 seconds continuous, Travel Speed Solenoid drive unit Measurement Voltage $> 3.0V$		●	
	4	(When Parking mode is not) (Detection) (When Travel Speed Solenoid is Off) 10 seconds continuous, Travel Speed Solenoid drive unit Measurement Voltage $\leq 3.0V$ (Cancellation) (When Travel Speed Solenoid is Off) 3 seconds continuous, Travel Speed Solenoid drive unit Measurement Voltage $> 3.0V$			●
	6	(Detection) (When Travel Speed Solenoid is On) 10 seconds continuous, Travel Speed Solenoid drive current $> 4.5 A$ (Cancellation) (When Travel Speed Solenoid is On) 3 seconds continuous, Travel Speed Solenoid drive current $\leq 4.5 A$	●		
	(Results / Symptoms) 1. Control Function – driving in 1/2 transmission operation failure (Checking list) 1. CN-70 (#1) – CN-52(#20) Checking Open/Short 2. CN-70 (#2) – CN-45(#B+ term) Checking Open/Short				

※ Some error codes are not applied to this machine.

G : General

C : Crawler Type

W : Wheel Type

DTC		Diagnostic Criteria	Application		
HCESPN	FMI		G	C	W
169	4	Monitor – Selecting attachment(breaker / crusher) (Detection) (When Attachment Conflux Solenoid is Off) 10 seconds continuous, Attachment Conflux Solenoid drive unit Measurement Voltage \leq 3.0V (Cancellation) (When Attachment Conflux Solenoid is Off) 3 seconds continuous, Attachment Conflux Solenoid drive unit Measurement Voltage $>$ 3.0V	●		
	6	(Detection) (When Attachment Conflux Solenoid is On) 10 seconds continuous, Attachment Conflux Solenoid drive Current $>$ 6.5 A (Cancellation) (When Attachment Conflux Solenoid is On) 3 seconds continuous, Attachment Conflux Solenoid drive Current \leq 6.5 A	●		
	(Results / symptoms) 1. Control Function – Option attachment flow control – Joining operation failure (Eco breaker mode, crusher mode) (Checking list) 1. CD-237 (#1) – CN-53 (#7) Checking Open/Short 2. CD-237 (#2) – CR-35 (#87) Checking Open/Short				
170	4	(Model Parameter) mounting Arm Regenerating Solenoid (Detection) (When Arm Regeneration Solenoid is Off) 10 seconds continuous, Arm Regeneration Solenoid drive unit Measurement Voltage \leq 3.0V (Cancellation) (When Arm Regeneration Solenoid is Off) 3 seconds continuous, Arm Regeneration Solenoid drive unit Measurement Voltage $>$ 3.0V	●		
	6	(Detection) (When Arm Regeneration Solenoid is On) 10 seconds continuous, Arm Regeneration Solenoid drive current $>$ 4.5 A (Cancellation) (When Arm Regeneration Solenoid is On) 3 seconds continuous, Arm Regeneration Solenoid drive current \leq 4.5 A	●		
	(Detection) (When Arm Regeneration Solenoid is On) 10 seconds continuous, Arm Regeneration Solenoid drive current $>$ 4.5 A (Cancellation) (When Arm Regeneration Solenoid is On) 3 seconds continuous, Arm Regeneration Solenoid drive current \leq 4.5 A				

※ Some error codes are not applied to this machine.

G : General

C : Crawler Type

W : Wheel Type

DTC		Diagnostic Criteria	Application		
HCESPN	FMI		G	C	W
171	4	Monitor – Selecting attachment(crusher) (Detection) (When Attachment Safety Solenoid is Off) 10 seconds continuous, Attachment Safety Solenoid drive unit Measurement Voltage ≤ 3.0V (Cancellation) (When Attachment Safety Solenoid is Off) 3 seconds continuous, Attachment Safety Solenoid drive unit Measurement Voltage > 3.0V	●		
	6	(Detection) (When Attachment Safety Solenoid is On) 10 seconds continuous, Attachment Safety Solenoid drive current > 6.5 A (Cancellation) (When Attachment Safety Solenoid is On) 3 seconds continuous, Attachment Safety Solenoid drive current ≤ 6.5 A	●		
(Results / Symptoms) 1. Control Function – Option attachment flow control – Option spool pilot pressure cut off failure (crusher mode) (Checking list) 1. CD-149 (#1) – CN-53 (#8) Checking Open/Short 2. CD-149 (#2) – CR-35 (#87) Checking Open/Short					
179	4	Monitor – Selecting attachment(breaker / crusher) (Detection) (When Breaker Operating Solenoid is Off) 10 seconds continuous, Attachment Safety Solenoid drive unit Measurement Voltage ≤ 3.0V (Cancellation) (When Breaker Operating Solenoid is Off) 3 seconds continuous, Attachment Safety Solenoid drive unit Measurement Voltage > 3.0V	●		
	6	(Detection) (When Breaker Operating Solenoid is On) 10 seconds continuous, Attachment Safety Solenoid drive current > 6.5 A (Cancellation) (When Breaker Operating Solenoid is On) 3 seconds continuous, Attachment Safety Solenoid drive current ≤ 6.5 A	●		
(Results / Symptoms) 1. Control Function – Option attachment flow control – Breaker operation failure (breaker mode) (Checking list) 1. CD-66 (#1) – CN-53 (#9) Checking Open/Short 2. CD-66 (#2) – CN-45 (#B+ term) Checking Open/Short 3. CD-66 (#C) – CN-51 (#13) Checking Open/Short					

※ Some error codes are not applied to this machine.

G : General

C : Crawler Type

W : Wheel Type

DTC		Diagnostic Criteria	Application		
HCESPN	FMI		G	C	W
181	4	(Model Parameter) mounting Reverse Cooling Fan Solenoid (Detection) (When Reverse Cooling Fan Solenoid is Off) 10 seconds continuous, Reverse Cooling Fan Solenoid drive unit Measurement Voltage $\leq 3.0V$ (Cancellation) (When Reverse Cooling Fan Solenoid is Off) 3 seconds continuous, Reverse Cooling Fan Solenoid drive unit Measurement Voltage $> 3.0V$	●		
	6	(Detection) (When Reverse Cooling Fan Solenoid is On) 10 seconds continuous, Reverse Cooling Fan Solenoid drive current $> 4.5 A$ (Cancellation) (When Reverse Cooling Fan Solenoid is On) 3 seconds continuous, Reverse Cooling Fan Solenoid drive current $\leq 4.5 A$	●		
(Results / Symptoms) 1. Control Function – Cooling Fan reverse control operation failure (not applicable)					
188	5	(Detection) (When Attachment Flow EPPR 1 current is equal or more than 300 mA) 10 seconds continuous, Attachment Flow EPPR drive current $< 100 mA$ (Cancellation) (When Attachment Flow EPPR 1 current is equal or more than 300 mA) 3 seconds continuous, Attachment Flow EPPR drive current $\geq 100 mA$	●		
	6	(Detection) 10 seconds continuous, Attachment Flow EPPR 1 drive current $> 1.0 A$ (Cancellation) 3 seconds continuous, Attachment Flow EPPR 1 drive current $\leq 1.0 A$	●		
(Results / Symptoms) 1. Control Function – IPC operation failure, Option attachment flow control operation failure (Checking list) 1. CN-242 (#2) – CN-52 (#39) Checking Open/Short 2. CN-242 (#1) – CN-52 (#40) Checking Open/Short					

※ Some error codes are not applied to this machine.

G : General

C : Crawler Type

W : Wheel Type

DTC		Diagnostic Criteria	Application		
HCESPN	FMI		G	C	W
189	5	(Detection) (When Attachment Flow EPPR 2 current is equal or more than 300 mA) 10 seconds continuous, Attachment Flow EPPR drive current < 100 mA (Cancellation) (When Attachment Flow EPPR 2 current is equal or more than 300 mA) 3 seconds continuous, Attachment Flow EPPR drive current ≥ 100 mA	●		
	6	(Detection) 10 seconds continuous, Attachment Flow EPPR 2 drive current > 1.0 A (Cancellation) 3 seconds continuous, Attachment Flow EPPR 2 drive current ≤ 1.0 A	●		
(Results / Symptoms) 1. Control Function – Option attachment flow control operation failure (Checking list) 1. CN-243 (#2) – CN-52 (#6) Checking Open/Short 2. CN-243 (#1) – CN-52 (#7) Checking Open/Short					
196	0	HW145 10 seconds continuous, Attachment flow control EPPR 1 press. Sensor Measurement Voltage > 5.2V			
	1	HW145 10 seconds continuous, 0.3V ≤ Attachment flow control EPPR 1 press. Sensor Measurement Voltage < 0.8V			
	4	HW145 10 seconds continuous, Attachment flow control EPPR 1 press. Sensor Measurement Voltage < 0.3V			
(Results / Symptoms) 1. Control Function – Driving second pump joining function operation failure (Checking list) 1. CD-33 (#B) – CN-52 (#11) Checking Open/Short 2. CD-33 (#A) – CN-51 (#3) Checking Open/Short 3. CD-33 (#C) – CN-51 (#13) Checking Open/Short					
200	0	10 seconds continuous, Pump EPPR Press. Sensor Measurement Voltage > 5.2V	●		
	1	10 seconds continuous, 0.3V ≤ Pump EPPR Press. Sensor Measurement Voltage < 0.8V	●		
	4	10 seconds continuous, Pump EPPR Press. Sensor Measurement Voltage < 0.3V	●		
	(Results / Symptoms) 1. Monitor – Pump EPPR Press. display failure 2. Control Function – Pump input horse power control failure, Overload at compensation control operation failure (Fuel efficiency/speed performance failure) (Checking list) 1. CD-44 (#B) – CN-52 (#32) Checking Open/Short 2. CD-44 (#A) – CN-51 (#3) Checking Open/Short 3. CD-44 (#C) – CN-51 (#13) Checking Open/Short				

※ Some error codes are not applied to this machine.

G : General

C : Crawler Type

W : Wheel Type

DTC		Diagnostic Criteria	Application		
HCESPN	FMI		G	C	W
205	0	(Mounting pressure sensor) 10 seconds continuous, Boom Cylinder Rod Press. Sensor Measurement Voltage > 5.2V	●		
	1	(Mounting pressure sensor) 10 seconds continuous, 0.3V ≤ Boom Cylinder Rod Press. Sensor Measurement Voltage < 0.8V	●		
	4	(Mounting pressure sensor) 10 seconds continuous, Boom Cylinder Rod Press. Sensor Measurement Voltage < 0.3V	●		
	(Results / Symptoms) 1. Monitor – Boom Cylinder Rod Press. display failure 2. Control Function – Boom floating control operation failure (Checking list) 1. CD-124 (#B) – CN-53 (#5) Checking Open/Short 2. CD-124 (#A) – CN-53 (#3) Checking Open/Short 3. CD-124 (#C) – CN-53 (#13) Checking Open/Short				
218	4	Mounting pressure sensor (HCESPN128 or HCESPN 205) (Detection) (When Boom Up Floating Solenoid is Off) 10 seconds continuous, Boom Up Floating Solenoid drive unit Measurement Voltage ≤ 3.0V (Cancellation) (When Boom Up Floating Solenoid is Off) 3 seconds continuous, Boom Up Floating Solenoid drive unit Measurement Voltage > 3.0V	●		
	6	(Detection) (When Boom Up Floating Solenoid is On) 10 seconds continuous, Boom Up Floating Solenoid drive current > 6.5 A (Cancellation) (When Boom Up Floating Solenoid is On) 3 seconds continuous, Boom Up Floating Solenoid drive current ≤ 6.5 A	●		
	(Results / Symptoms) 1. Control Function – Boom floating control operation failure (Checking list) 1. CD-368 (#1) – CN-53 (#20) Checking Open/Short 2. CD-368 (#2) – CR-35 (#87) Checking Open/Short				

※ Some error codes are not applied to this machine.

G : General

C : Crawler Type

W : Wheel Type

DTC		Diagnostic Criteria	Application		
HCESPN	FMI		G	C	W
220	4	Mounting pressure sensor (HCESPN 128 or 205) (Detection) (When Boom Down Pilot Pressure Cutoff Solenoid is Off) 10 seconds continuous, Boom Down Pilot Pressure Cutoff Solenoid drive unit Measurement Voltage \leq 3.0V (Cancellation) (When Boom Down Pilot Pressure Cutoff Solenoid is Off) 3 seconds continuous, Boom Down Pilot Pressure Cutoff Solenoid drive unit Measurement Voltage $>$ 3.0V	●		
	6	(Detection) (When Boom Down Pilot Pressure Cutoff Solenoid is On) 10 seconds continuous, Boom Down Pilot Pressure Cutoff Solenoid drive current $>$ 6.5 A (Cancellation) (When Boom Down Pilot Pressure Cutoff Solenoid is On) 3 seconds continuous, Boom Down Pilot Pressure Cutoff Solenoid drive current \leq 6.5 A	●		
(Results / Symptoms) 1. Control Function – Boom floating control operation failure (Checking list) 1. CD-369 (#1) – CN-53 (#35) Checking Open/Short 2. CD-369 (#2) – CR-35 (#87) Checking Open/Short					
221	5	Monitor – Selecting attachment(breaker / crusher) (Detection) (When ATT Relief Setting EPPR 1 Current is equal or more than 10 mA) 10 seconds continuous, ATT Relief Setting EPPR 1 drive current = 0 mA (Cancellation) ATT Relief Setting EPPR 1 Current is equal or more than 10 mA) 3 seconds continuous, ATT Relief Setting EPPR 1 drive current \geq 10 mA	●		
	6	(Detection) 10 seconds continuous, ATT Relief Setting EPPR 1 drive current $>$ 1.0 A (Cancellation) 3 seconds continuous, ATT Relief Setting EPPR 1 drive current \leq 1.0 A	●		
(Results / Symptoms) 1. Control Function – Option attachment flow control – P1 relief pressure setting failure (Checking list) 1. CD-365 (#2) – CN-53 (#39) Checking Open/Short 2. CD-365 (#1) – CN-53 (#40) Checking Open/Short					

※ Some error codes are not applied to this machine.

G : General

C : Crawler Type

W : Wheel Type

DTC		Diagnostic Criteria	Application		
HCESPN	FMI		G	C	W
222	5	Monitor – Selecting attachment(crusher) (Detection) (When ATT Relief Setting EPPR 2 Current is equal or more than 10 mA) 10 seconds continuous, ATT Relief Setting EPPR 2 drive current = 0 mA (Cancellation) (When ATT Relief Setting EPPR 2 Current is equal or more than 10 mA) 3 seconds continuous, ATT Relief Setting EPPR 2 drive current ≥ 10mA	●		
	6	(Detection) 10 seconds continuous, ATT Relief Setting EPPR 2 drive current > 1.0 A (Cancellation) 3 seconds continuous, ATT Relief Setting EPPR 2 drive current ≤ 1.0 A	●		
(Results / Symptoms) 1. Control Function – Option attachment flow control – P2 relief pressure setting failure (Checking list) 1. CD-366 (#2) – CN-53 (#32) Checking Open/Short 2. CD-366 (#1) – CN-53 (#33) Checking Open/Short					
301	3	10 seconds continuous, Fuel Level Measurement Voltage > 3.8V	●		
	4	10 seconds continuous, Fuel Level Measurement Voltage < 0.3V	●		
	(Results / Symptoms) 1. Monitor – Fuel remaining display failure (Checking list) 1. CD-2 (#2) – CN-52 (#26) Checking Open/Short 2. CD-2 (#1) – CN-51 (#5) Checking Open/Short				
325	4	(Model Parameter) mounting Fuel Warmer Relay (Detection) (When Fuel Warmer Relay is Off) 10 seconds continuous, Fuel Warmer Relay drive unit Measurement Voltage ≤ 3.0V (Cancellation) (When Fuel Warmer Relay is Off) 3 seconds continuous, Fuel Warmer Relay drive unit Measurement Voltage > 3.0V	●		
	6	(Detection) (When Fuel Warmer Relay is On) 10 seconds continuous, Fuel Warmer Relay drive current > 4.5 A (Cancellation) (When Fuel Warmer Relay is On) 3 seconds continuous, Fuel Warmer Relay drive current ≤ 4.5 A	●		
(Results / Symptoms) 1. Control Function – Fuel warmer operation failure (Checking list) 1. CR-46 (#85) – CN-52 (#30) Checking Open/Short 2. CR-46 (#86) – CN-45 (#B+ term) Checking Open/Short					

※ Some error codes are not applied to this machine.

G : General

C : Crawler Type

W : Wheel Type

DTC		Diagnostic Criteria	Application		
HCESPN	FMI		G	C	W
501	0	10 seconds continuous, Transmission Oil Press. Sensor Measurement Voltage > 5.2V			●
	1	10 seconds continuous, 0.3V ≤ Transmission Oil Press. Sensor Measurement Voltage < 0.8V			●
	4	10 seconds continuous, Transmission Oil Press. Sensor Measurement Voltage < 0.3V			●
	(Results / Symptoms) 1. Monitor – Transmission Oil Press. display failure, Transmission Oil low pressure warning failure (Checking list) 1. CD-5 (#B) – CN-54 (#27) Checking Open/Short 2. CD-5 (#A) – CN-54 (#3) Checking Open/Short 3. CD-5 (#C) – CN-54 (#13) Checking Open/Short				
503	0	10 seconds continuous, Brake Oil Press. Sensor Measurement Voltage > 5.2V			●
	1	10 seconds continuous, 0.3V ≤ Brake Oil Press. Sensor Measurement Voltage < 0.8V			●
	4	10 seconds continuous, Brake Oil Press. Sensor Measurement Voltage < 0.3V			●
	(Results / Symptoms) 1. Monitor – Brake Oil Press. display failure, Brake Oil low pressure warning failure (Checking list) 1. CD-3 (#B) – CN-54 (#4) Checking Open/Short 2. CD-3 (#A) – CN-54 (#3) Checking Open/Short 3. CD-3 (#C) – CN-54 (#13) Checking Open/Short				
505	0	10 seconds continuous, Working Brake Press. Sensor Measurement Voltage > 5.2V			●
	1	10 seconds continuous, 0.3V ≤ Working Brake Press. Sensor Measurement Voltage < 0.8V			●
	4	10 seconds continuous, Working Brake Press. Sensor Measurement Voltage < 0.3V			●
	(Results / Symptoms) 1. Monitor – Working Brake Oil Press. display failure, Working Brake Oil low pressure warning failure (Checking list) 1. CD-38 (#B) – CN-54 (#5) Checking Open/Short 2. CD-38 (#A) – CN-54 (#3) Checking Open/Short 3. CD-38 (#C) – CN-54 (#13) Checking Open/Short				

※ Some error codes are not applied to this machine.

G : General

C : Crawler Type

W : Wheel Type

DTC		Diagnostic Criteria	Application		
HCESPN	FMI		G	C	W
514	4	(Detection) (When Parking Relay is Off) 10 seconds continuous, Parking Relay drive unit Measurement Voltage $\leq 3.0V$ (Cancellation) (When Parking Relay is Off) 3 seconds continuous, Parking Relay drive unit Measurement Voltage $> 3.0V$			●
	6	(Detection) (When Parking Relay is On) 10 seconds continuous, Parking Relay drive current $> 6.5 A$ (Cancellation) (When Parking Relay is On) 3 seconds continuous, Parking Relay drive current $\leq 6.5 A$			●
(Results / Symptoms) 1. Control Function – Parking Relay operation failure (Checking list) 1. CR-66 (#1) – CN-54 (#20) Checking Open/Short 2. CR-66 (#2) – CN-45 (#B+ term) Checking Open/Short					
517	4	(Detection) (When Traveling Cutoff Relay is Off) 10 seconds continuous, Traveling Cutoff Relay drive unit Measurement Voltage $\leq 3.0V$ (Cancellation) (When Traveling Cutoff Relay is Off) 3 seconds continuous, Traveling Cutoff Relay drive unit Measurement Voltage $> 3.0V$			●
	6	(Detection) (When Traveling Cutoff Relay is On) 10 seconds continuous, Traveling Cutoff Relay drive current $> 6.5 A$ (Cancellation) (When Traveling Cutoff Relay is On) 3 seconds continuous, Traveling Cutoff Relay drive current $\leq 6.5 A$			●
(Results / Symptoms) 1. Control Function – Traveling Cutoff Relay operation failure (Checking list) 1. CR-47 (#85) – CN-54 (#9) Checking Open/Short 2. CR-47 (#86) – CN-45 (#B+ term) Checking Open/Short					

※ Some error codes are not applied to this machine.

G : General

C : Crawler Type

W : Wheel Type

DTC		Diagnostic Criteria	Application		
HCESPN	FMI		G	C	W
525	4	(Detection) (When Ram Lock Solenoid is Off) 10 seconds continuous, Ram Lock Solenoid drive unit Measurement Voltage $\leq 3.0V$ (Cancellation) (When Ram Lock Solenoid is Off) 3 seconds continuous, Ram Lock Solenoid drive unit Measurement Voltage $> 3.0V$			●
	6	(Detection) (When Ram Lock Solenoid is On) 10 seconds continuous, Ram Lock Solenoid drive current $> 6.5 A$ (Cancellation) (When Ram Lock Solenoid is On) 3 seconds continuous, Ram Lock Solenoid drive current $\leq 6.5 A$			●
(Results / Symptoms) 1. Control Function – Ram lock control operation failure (Checking list) 1. CN-69 (#1) – CN-54 (#8) Checking Open/Short 2. CN-69 (#2) – CN-45 (#B+ term) Checking Open/Short					
527	4	(Detection) (When Creep Solenoid is Off) 10 seconds continuous, Creep Solenoid drive unit Measurement Voltage $\leq 3.0V$ (Cancellation) (When Creep Solenoid is Off) 3 seconds continuous, Creep Solenoid drive unit Measurement Voltage $> 3.0V$			●
	6	(Detection) (When Creep Solenoid is On) 10 seconds continuous, Creep Solenoid drive current $> 6.5 A$ (Cancellation) (When Creep Solenoid is On) 3 seconds continuous, Creep Solenoid drive current $\leq 6.5 A$			●
(Results / Symptoms) 1. Control Function – Creep mode operation failure (Checking list) 1. CN-206 (#1) – CN-54 (#7) Checking Open/Short 2. CN-206 (#2) – CN-45 (#B+ term) Checking Open/Short					

※ Some error codes are not applied to this machine.

G : General

C : Crawler Type

W : Wheel Type

DTC		Diagnostic Criteria	Application		
HCESPN	FMI		G	C	W
530	0	10 seconds continuous, Travel Forward Press. Sensor Measurement Voltage > 5.2V			●
	1	10 seconds continuous, 0.3V ≤ Travel Forward Press. Sensor Measurement Voltage < 0.8V			●
	4	10 seconds continuous, Travel Forward Press. Sensor Measurement Voltage < 0.3V			●
	(Results / Symptoms) 1. Monitor – Travel Forward Press. display failure 2. Control Function – Driving interoperability power control operation failure (Checking list) 1. CD-73 (#B) – CN-54 (#6) Checking Open/Short 2. CD-73 (#A) – CN-54 (#3) Checking Open/Short 3. CD-73 (#C) – CN-54 (#13) Checking Open/Short				
531	1	10 seconds continuous, 0.3V ≤ Travel Reverse Press. Sensor Measurement Voltage < 0.8V			●
	4	10 seconds continuous, Travel Reverse Press. Sensor Measurement Voltage < 0.3V			●
	(Results / Symptoms) 1. Monitor – Travel Reverse Press. display failure 2. Control Function – Driving interoperability power control operation failure (Checking list) 1. CD-74 (#B) – CN-54 (#23) Checking Open/Short 2. CD-74 (#A) – CN-54 (#3) Checking Open/Short 3. CD-74 (#C) – CN-54 (#13) Checking Open/Short				
705	0	10 seconds continuous, Battery input Voltage > 35V	●		
	1	10 seconds continuous, Battery input Voltage < 18V	●		
	(Results / Symptoms) 1. Control Function – Startup impossibility (Checking list) 1. CS-74A (#1) – CN-51 (#1) Checking Open/Short				
707	1	(When Engine is equal or more than 400 rpm) 10 seconds continuous, Alternator Node L Measurement Voltage < 18V (In case 12v goods, Alternator Node L Measurement Voltage < 9V)	●		
	(Results / Symptoms) 1. Control Function – Battery charging circuit failure (Checking list) 1. CS-74A (#1) – CN-51 (#2) Checking Open/Short				

※ Some error codes are not applied to this machine.

G : General

C : Crawler Type

W : Wheel Type

DTC		Diagnostic Criteria	Application		
HCESPN	FMI		G	C	W
714	3	(Model Parameter) Mounting Acc. Dial 10 seconds continuous, Acc. Dial Measurement Voltage > 5.2V	●		
	4	(Model Parameter) Mounting Acc. Dial 10 seconds continuous, Acc. Dial Measurement Voltage < 0.3V	●		
	(Results / Symptoms) 1. Monitor – Acc. Dial Voltage display failure 2. Control Function – Engine rpm control failure (Checking list) 1. CN-7 (#15) – CN-52 (#23) Checking Open/Short				
722	4	(Detection) (When Travel Alarm (Buzzer) Sound is Off) 10 seconds continuous, Travel Alarm (Buzzer) Sound Relay drive unit Measurement Voltage ≤ 3.0V (Cancellation) (When Travel Alarm (Buzzer) Sound Relay is Off) 3 seconds continuous, Travel Alarm (Buzzer) Sound Relay drive unit Measurement Voltage > 3.0V		●	
	6	(Detection) (When Travel Alarm (Buzzer) Sound is On) 10 seconds continuous, Travel Alarm (Buzzer) Sound Relay drive current > 4.5 A (Cancellation) (When Travel Alarm (Buzzer) Sound is On) 3 seconds continuous, Travel Alarm (Buzzer) Sound Relay drive current ≤ 4.5 A		●	
	(Results / Symptoms) 1. Control Function – Driving alarm operation failure (Checking list) 1. CN-81 (#1) – CN-52 (#31) Checking Open/Short 2. CN-81 (#2) – CN-45 (#B+ term) Checking Open/Short				
831	2	(When mounting the A/C Controller) 60 seconds continuous, A/C Controller Communication Data Error	●		
	(Results / Symptoms) 1. Control Function – A/C Controller operation failure (Checking list) 1. CN-11 (#8) – CN-51 (#22) Checking Open/Short 2. CN-11 (#7) – CN-51 (#32) Checking Open/Short				
840	2	60 seconds continuous, Cluster Communication Data Error	●		
	(Results / Symptoms) 1. Control Function – Cluster operation failure (Checking list) 1. CN-56A (#7) – CN-51 (#22) Checking Open/Short 2. CN-56A (#6) – CN-51 (#32) Checking Open/Short				

※ Some error codes are not applied to this machine.

G : General

C : Crawler Type

W : Wheel Type

DTC		Diagnostic Criteria	Application		
HCESPN	FMI		G	C	W
841	2	10 seconds continuous, ECM Communication Data Error	●		
	(Results / Symptoms) 1. Control Function – ECM operation failure (Checking list) 1. CN-93 (#22) – CN-51 (#21) Checking Open/Short 2. CN-93 (#46) – CN-51 (#31) Checking Open/Short				
845	2	(When mounting the I/O Controller 1) 60 seconds continuous, I/O Controller 1 Communication Data Error	●		
	(Results / Symptoms) 1. Control Function – I/O Controller 1 operation failure (Checking list) 1. CN-53 (#21) – CN-51 (#23) Checking Open/Short 2. CN-53 (#31) – CN-51 (#33) Checking Open/Short				
848	2	(When mounting the Haptic Controller) 60 seconds continuous, Haptic Controller Communication Data Error	●		
	(Results / Symptoms) 1. Control Function – Haptic Controller operation failure (Checking list) 1. CN-8 (#2) – CN-51 (#22) Checking Open/Short 2. CN-8 (#3) – CN-51 (#32) Checking Open/Short				
850	2	(When mounting the RMCU) 60 seconds continuous, RMCU communication Data Error	●		
	(Results / Symptoms) 1. Control Function – RMCU operation failure (Checking list) 1. CN-125 (#3) – CN-51 (#22) Checking Open/Short 2. CN-125 (#11) – CN-51 (#32) Checking Open/Short				
861	2	(When mounting the I/O Controller 2) 60 seconds continuous, I/O Controller 2 communication Data Error	●		
	(Results / Symptoms) 1. Control Function – I/O Controller 2 operation failure (Checking list) 1. CN-54 (#21) – CN-51 (#23) Checking Open/Short 2. CN-54 (#31) – CN-51 (#33) Checking Open/Short				

※ Some error codes are not applied to this machine.

G : General

C : Crawler Type

W : Wheel Type

DTC		Diagnostic Criteria	Application		
HCESPN	FMI		G	C	W
866	2	(When mounting the AAVM) 60 seconds continuous, AAVM communication Data Error	●		
	(Results / Symptoms) 1. Control Function – AAVM operation failure (Checking list) 1. CN-401 (#86) – CN-51 (#22) Checking Open/Short 2. CN-401 (#87) – CN-51 (#32) Checking Open/Short				
867	2	60 seconds continuous, RDU communication Data Error	●		
	(Results / Symptoms) 1. Control Function – RDU operation failure (Checking list) 1. CN-376 (#10) – CN-51 (#22) Checking Open/Short 2. CN-376 (#18) – CN-51 (#32) Checking Open/Short				
868	2	60 seconds continuous, Switch Controller communication Data Error	●		
	(Results / Symptoms) 1. Control Function – Switch Controller operation failure (Checking list) 1. CN-56A (#7) – CN-51 (#22) Checking Open/Short 2. CN-56A (#6) – CN-51 (#32) Checking Open/Short				
869	2	(When mounting the BKCU) 60 seconds continuous, BKCU communication Data Error	●		
	(Results / Symptoms) 1. Control Function – BKCU operation failure (Checking list) 1. CS-2B (#A) – CN-51 (#22) Checking Open/Short 2. CS-2B (#B) – CN-51 (#32) Checking Open/Short				

※ Some error codes are not applied to this machine.

G : General

C : Crawler Type

W : Wheel Type

4. ENGINE FAULT CODE

Fault code J1939 SPN J1939 FMI	Reason	Effect (only when fault code is active)
111 629 12	Engine control module critical internal failure - Bad intelligent device or component. Error internal to the ECM related to memory hardware failures or internal ECM voltage supply circuits.	Possible no noticeable performance effects, engine dying, or hard starting.
115 612 2	Engine magnetic crankshaft speed/position lost both of two signals - Data erratic, intermittent, or incorrect. The ECM has detected the primary and backup speed sensor signals are connected backwards.	The engine will shut down or will not start.
122 102 3	Intake manifold 1 pressure sensor circuit - Voltage above normal, or shorted to high source. High signal voltage detected at the intake manifold pressure circuit.	Engine power derate.
123 102 4	Intake manifold 1 pressure sensor circuit - Voltage below normal, or shorted to low Source. Low signal voltage or open circuit detected at the intake manifold pressure circuit.	Engine power derate.
124 102 16	Intake manifold 1 pressure - Data valid but above normal operational range - Moderately severe level. Intake manifold pressure is above the maximum operating limit.	Engine power derate.
125 102 18	Intake Manifold 1 Pressure - Data valid but below normal operating range - Moderately severe level. Intake manifold pressure is below the minimum operating limit.	Engine power derate.
131 91 3	Accelerator pedal or lever position sensor 1 circuit - Voltage above normal, or shorted to high source. High voltage detected at accelerator pedal position number 1 circuit.	The engine will operate in limp home mode.
132 91 4	Accelerator pedal or lever position sensor 1 circuit - Voltage below normal, or shorted to low source. Low voltage detected at accelerator pedal position number 1 signal circuit.	The engine will operate in limp home mode.
133 974 3	Remote accelerator pedal or lever position sensor 1 circuit - Voltage above normal, or shorted to high source. High voltage detected at remote accelerator pedal position signal circuit.	Remote accelerator will not operate.
134 974 4	Remote accelerator pedal or lever position sensor 1 circuit - Voltage below normal, or shorted to low source. Low voltage detected at remote accelerator pedal position signal circuit.	Remote accelerator will not operate.
143 100 18	Engine oil rifle pressure - Data valid but below normal operational range - Moderately severe level. Engine oil pressure signal indicates engine oil pressure is below the engine protection warning limit.	Engine power derate.

※ Some fault codes are not applied to this machine.

Fault code J1939 SPN J1939 FMI	Reason	Effect (only when fault code is active)
144 110 3	Engine coolant temperature 1 sensor circuit - Voltage above normal, or shorted to high source. High signal voltage or open circuit detected at engine coolant temperature circuit.	Fan will stay ON if controlled by ECM.
145 110 4	Engine coolant temperature 1 sensor circuit - Voltage below normal, or shorted to low source. Low signal voltage detected at engine coolant temperature circuit.	Fan will stay ON if controlled by ECM.
146 110 16	Engine coolant temperature - Data valid but above normal operational range - Moderately severe level. Engine coolant temperature is above engine protection warning limit.	Progressive power and/or speed derate increasing in severity from time of alert. If the engine protection shutdown feature is enabled, the engine will shut down 30 seconds after the red stop lamp starts flashing.
151 110 0	Engine coolant temperature - Data valid but above normal operational range - Most severe level. Engine coolant temperature signal indicates engine coolant temperature above engine protection critical limit.	Progressive power and/or speed derate increasing in severity from time of alert. If the engine protection shutdown feature is enabled, the engine will shut down 30 seconds after the red stop lamp starts flashing.
153 105 3	Intake manifold 1 temperature sensor circuit - Voltage above normal, or shorted to high source. High signal voltage detected at intake manifold air temperature circuit.	Fan will stay ON if controlled by ECM.
154 105 4	Intake manifold 1 temperature sensor circuit - Voltage below normal, or shorted to low source. Low signal voltage detected at intake manifold air temperature circuit.	Fan will stay ON if controlled by ECM.
155 105 0	Intake manifold 1 temperature - Data valid but above normal operational range - Most severe level. Intake manifold air temperature signal indicates intake manifold air temperature above engine protection critical limit.	Progressive power and/or speed derate increasing in severity from time of alert. If the engine protection shutdown feature is enabled, the engine will shut down 30 seconds after the red stop lamp starts flashing.
175 3464 3	Electronic throttle control actuator driver circuit - Voltage above normal, or shorted to high source. A short circuit to battery or open circuit has been detected in the engine intake air throttle actuator signal circuit.	Possible reduced engine performance.
176 3464 4	Electronic throttle control actuator driver circuit - Voltage below normal, or shorted to low source. A short circuit to ground has been detected in the engine intake air throttle actuator signal circuit.	Possible reduced engine performance.
177 3464 7	Electronic throttle control actuator - Mechanical system not responding or out of adjustment. The engine intake air throttle actuator has failed the auto zero span check.	Possible reduced engine performance.
187 3510 4	Sensor supply 2 circuit - Voltage below normal, or shorted to low source. Low voltage detected at the sensor supply number 2 circuit.	Engine power derate.
195 111 3	Coolant level sensor 1 circuit - Voltage above normal, or shorted to high source. High signal voltage detected at engine coolant level circuit.	None on performance.

※ Some fault codes are not applied to this machine.

Fault code J1939 SPN J1939 FMI	Reason	Effect (only when fault code is active)
196 111 4	Coolant level sensor 1 circuit - Voltage below normal, or shorted to low source. Low signal voltage detected at engine coolant level circuit.	None on performance.
197 111 18	Coolant level - Data valid but below normal operational range - Moderately severe level. Low coolant level has been detected.	Engine power derate.
221 108 3	Barometric pressure sensor circuit - Voltage above normal, or shorted to high source. High signal voltage detected at barometric pressure circuit.	Engine power derate.
222 108 4	Barometric pressure sensor circuit - Voltage below normal, or shorted to low source. Low signal voltage detected at barometric pressure circuit.	Engine power derate.
227 3510 3	Sensor supply 2 circuit - Voltage above normal, or shorted to high source. High voltage detected at sensor supply number 2 circuit.	Engine power derate.
234 190 0	Engine crankshaft speed/position - Data valid but above normal operational range - Most severe level. Engine speed signal indicates engine speed above engine protection limit.	Engine power derate.
238 3511 4	Sensor supply 3 circuit - Voltage below normal, or shorted to low source. Low voltage detected on the +5 volt sensor supply circuit to the engine speed sensor.	Engine may run rough, may stop running, may not start, or may be difficult to start.
239 3511 3	Sensor supply 3 circuit - Voltage above normal or shorted to high source. High voltage detected on the 5 volt sensor supply circuit to the engine speed sensor.	Engine may run rough, may stop running, may not start, or may be difficult to start.
241 84 2	Wheel-based vehicle speed - Data erratic, intermittent, or incorrect. The ECM lost the vehicle speed signal or is reading an erratic value.	Engine speed limited to ,maximum engine speed without VSS parameter value. Cruise control, gear-down protection, and road speed governor will not work.
245 647 4	Fan control circuit - Voltage below normal, or shorted to low source. Low signal voltage detected at the fan control circuit when commanded on.	The fan may stay on continuously or not run at all.
249 171 3	Ambient air temperature sensor 1 circuit - Voltage above normal or shorted to high source. High signal voltage detected at ambient air temperature circuit.	Possible reduced engine performance.
256 171 4	Ambient air temperature sensor 1 circuit - Voltage below normal or shorted to low source. Low voltage detected at ambient air temperature circuit.	Possible reduced engine performance.
271 1347 4	Fuel pump pressurizing assembly 1 circuit - Voltage below normal, or shorted to low source. Low signal voltage detected at the fuel pump actuator circuit.	Engine power derate.

※ Some fault codes are not applied to this machine.

Fault code J1939 SPN J1939 FMI	Reason	Effect (only when fault code is active)
272 1347 3	Fuel pump pressurizing assembly 1 circuit - Voltage above normal, or shorted to high source. High signal voltage or open circuit detected at the fuel pump actuator circuit.	Engine may run rough, may stop running, may not start, or may be difficult to start.
285 639 9	SAE J1939 multiplexing PGN timeout error - Abnormal update rate. The ECM expected information from a multiplexed device but did not receive it soon enough or did not receive it at all.	At least one multiplexed device will not operate properly.
286 639 13	SAE J1939 multiplexing configuration error - Out of calibration. The ECM expected information from a multiplexed device but only received a portion of the necessary information.	At least one multiplexed device will not operate properly.
288 974 19	Sae J1939 multiplexing remote accelerator pedal or lever position sensor circuit - Received network data in error. The oem vehicle electronic control unit (VECM) detected a fault with the remote accelerator.	Remote accelerator will not operate.
295 108 2	Barometric pressure - Data erratic, intermittent, or incorrect. An error in the barometric pressure sensor signal was detected by the ECM.	Engine power derate.
322 651 5	Injector solenoid driver cylinder 1 circuit - Current below normal, or open circuit. Current detected at injector 1 when voltage is turned OFF.	Engine power derate.
323 655 5	Injector solenoid driver cylinder 5 circuit - Current below normal, or open circuit. Current detected at injector 5 when voltage is turned OFF.	The current to the injector is shut OFF. Engine power derate.
324 653 5	Injector solenoid driver cylinder 3 circuit - Current below normal, or open circuit. Current detected at injector 3 when voltage is turned OFF.	The current to the injector is shut OFF. Engine power derate.
325 656 5	Injector solenoid driver cylinder 6 circuit - Current below normal, or open circuit. Current detected at injector 6 when voltage is turned OFF.	The current to the injector is shut OFF. Engine power derate.
331 652 5	Injector solenoid driver cylinder 2 circuit - Current below normal, or open circuit. Current detected at injector 2 when voltage is turned OFF.	The current to the injector is shut OFF. Engine power derate.
332 654 5	Injector solenoid driver cylinder 4 circuit - Current below normal, or open circuit. Current detected at injector 4 when voltage is turned OFF.	The current to the injector is shut OFF. Engine power derate.
334 110 2	Engine coolant temperature - Data erratic, intermittent, or incorrect. The engine coolant temperature sensor is reading an erratic value at initial key ON.	None on performance.

※ Some fault codes are not applied to this machine.

Fault code J1939 SPN J1939 FMI	Reason	Effect (only when fault code is active)
338 1267 3	Idle shutdown vehicle accessories relay driver circuit - Voltage above normal, or shorted to high source. Open circuit or short to voltage source detected at the idle shutdown vehicle accessory/ignition bus relay circuit.	Vehicle accessories or ignition bus loads controlled by the idle shutdown relay will not power up.
339 1267 4	Idle shutdown vehicle accessories relay driver circuit - Voltage below normal, or shorted to low source. Low voltage detected at the idle shutdown vehicle accessory or ignition bus relay circuit when commanded ON.	Vehicle accessories or ignition bus loads controlled by the idle shutdown relay will not power up.
343 629 12	Engine control module warning internal hardware failure - Bad intelligent device or component. ECM power supply errors have been detected.	Engine power derate.
346 630 12	Engine control module calibration memory software - Bad intelligent device or component. Invalid switch configuration adjustable parameter setting have been detected by the engine control module (ECM).	Various optional switch inputs to the ECM may not operate correctly.
351 627 12	Injector power supply - Bad intelligent device or component. The ECM measured injector boost voltage is low.	Engine power derate.
352 3509 4	Sensor supply 1 circuit - Voltage below normal, or shorted to low source. Low voltage detected at sensor supply number 1 circuit.	Engine power derate.
383 729 5	Engine intake air heater 1 circuit - Current below normal or open circuit. A malfunctioning engine intake air heater circuit has been detected.	Engine may not start or may be difficult to start.
386 3509 3	Sensor supply 1 circuit - Voltage above normal, or shorted to high source. High voltage detected at sensor supply number 1 circuit.	Engine power derate.
415 100 1	Engine oil rifle pressure - Data valid but below normal operational range - Most severe level. Oil pressure signal indicates oil pressure below the engine protection critical limit.	Progressive power and/or speed derate increasing in severity from time of alert. If engine protection shutdown feature is enabled, engine will shut down 30 seconds after red stop lamp starts flashing.
418 97 15	Water in fuel indicator - Data valid but above normal operational range - Least severe level. water has been detected in the fuel filter.	None on performance.
427 639 9	J1939 data link - Abnormal update rate. Communication between the engine control module (ECM) and another device on the SAE J1939 data link has been lost.	Engine will only idle.
428 97 3	Water in fuel indicator sensor circuit - Voltage above normal, or shorted to high source. High voltage detected at the water in fuel circuit.	None on performance. No water in fuel warning available.
435 100 2	Engine oil rifle pressure - Data erratic, intermittent, or incorrect. The engine oil pressure sensor is reading an erratic value.	None on performance.

※ Some fault codes are not applied to this machine.

Fault code J1939 SPN J1939 FMI	Reason	Effect (only when fault code is active)
436 105 2	Intake manifold 1 temperature - Data erratic, intermittent, or incorrect. The intake manifold temperature sensor is reading an erratic value at initial key on or while the engine is running.	Possible reduced engine performance.
441 168 18	Battery 1 voltage - Data valid but below normal operational range - Moderately severe level. ECM supply voltage is below the minimum system voltage level.	Engine may run rough, may stop running, may not start, or may be difficult to start.
442 168 16	Battery 1 Voltage - Data valid but above normal operational range - Moderately severe level. ECM supply voltage is above the maximum system voltage level.	None on performance.
451 157 3	Injector metering rail 1 pressure sensor circuit - Voltage above normal, or shorted to high source. High signal voltage detected at the rail fuel pressure sensor circuit.	Power and/or speed derate.
452 157 4	Injector metering rail 1 pressure sensor circuit - Voltage below normal, or shorted to low source. Low signal voltage detected at the rail fuel pressure sensor circuit.	Power and/or speed derate.
483 1349 3	Injector metering rail 2 pressure sensor circuit - Voltage above normal or shorted to high source. High signal voltage detected at the fuel rail 2 pressure sensor circuit.	Possible reduced engine performance.
484 1349 4	Injector metering rail 2 pressure sensor circuit - Voltage below normal or shorted to low source. Low signal voltage detected at the fuel rail 2 pressure sensor circuit.	Possible reduced engine performance.
515 3514 3	Sensor supply 6 circuit - Voltage above normal or shorted to high source. High voltage detected on the +5 volt sensor supply circuit to the fuel rail pressure sensor.	Engine power derate.
516 3514 4	Sensor supply 6 circuit - Voltage below normal or shorted to low source. Low voltage detected on the +5 volt sensor supply circuit to the fuel rail pressure sensor.	Engine power derate.
553 157 16	Injector metering rail 1 pressure - Data valid but above normal operational range - Moderately severe level. The ECM has detected that fuel pressure is higher than commanded pressure.	Possible reduced engine performance.
555 101 16	Crankcase pressure - Data valid but above normal operational range - Moderately severe level. The crankcase breather filter requires maintenance.	None on performance.
556 101 0	Crankcase pressure - Data valid but above normal operational range - Most severe level. The crankcase breather filter requires maintenance.	None on performance.

※ Some fault codes are not applied to this machine.

Fault code J1939 SPN J1939 FMI	Reason	Effect (only when fault code is active)
559 157 18	Injector metering rail 1 pressure - Data valid but below normal operational range - Moderately severe level. The ECM has detected that fuel pressure is lower than commanded pressure.	Possibly hard to start or low power. Engine could possibly not start.
584 677 3	Starter relay driver circuit - Voltage above normal, or shorted to high source. Open circuit or high voltage detected at starter lockout circuit.	Either the engine will not start or the engine will not have starter lockout protection.
585 677 4	Starter relay driver circuit - Voltage below normal, or shorted to low source. Low voltage detected at starter lockout circuit.	Either the engine will not start or the engine will not have starter lockout protection.
595 103 16	Turbocharger 1 speed - Data valid but above normal operating range - Moderately severe level. High turbocharger speed has been detected by the ecm.	Engine power derate.
596 167 16	Electrical charging system voltage - Data valid but above normal operational range - Moderately severe level. High battery voltage detected by the battery voltage monitor feature.	None on performance.
597 167 18	Electrical charging system voltage - Data valid but below normal operational range - Moderately severe level. Low battery voltage detected by the battery voltage monitor feature.	None on performance.
649 1378 31	Engine oil change interval - Condition exists. Change engine oil and filter.	None on performance.
687 103 18	Turbocharger 1 speed - Data valid but below normal operational range - Moderately severe level. Low turbocharger speed detected by the ECM.	Engine power derate. The ECM uses an estimated turbocharger speed.
689 190 2	Engine crankshaft speed/position - Data erratic, intermittent, or incorrect. The ECM has detected an error in the engine speed signal.	Possible reduced engine performance.
691 1172 3	Turbocharger 1 compressor inlet temperature sensor circuit - Voltage above normal, or shorted to high source. High signal voltage detected at turbocharger compressor inlet air temperature circuit.	Engine power derate.
692 1172 4	Turbocharger 1 compressor inlet temperature circuit - Voltage below normal, or shorted to low source. Low signal voltage detected at turbocharger compressor inlet air temperature circuit.	Engine power derate.
693 1172 2	Turbocharger 1 compressor intake temperature - Data erratic, intermittent, or incorrect. A temperature too high or low for the operating conditions has been detected by the turbocharger compressor intake temperature sensor.	Possible reduced engine performance.

※ Some fault codes are not applied to this machine.

Fault code J1939 SPN J1939 FMI	Reason	Effect (only when fault code is active)
731 723 7	Engine speed / position camshaft and crankshaft misalignment - Mechanical system not responding properly or out of adjustment. Engine position signal from the crankshaft position sensor and camshaft position sensor do not match.	Engine power derate.
755 157 7	Injector metering rail 1 pressure - Mechanical system not responding or out of adjustment. The ECM has detected a difference in the 2 fuel rail pressure signals.	Possible reduced engine performance.
778 723 2	Engine camshaft speed / position sensor - Data erratic, intermittent, or incorrect. The ECM has detected an error in the camshaft position sensor signal.	Possible reduced engine performance.
784 1590 2	Adaptive cruise control mode - Data erratic, intermittent, or incorrect. Loss of communication with adaptive cruise control.	Adaptive cruise control will not operate. Standard cruise control may not operate.
1117 627 2	Power supply lost with ignition on - Data erratic, intermittent, or incorrect. Supply voltage to the ECM fell below 6.2 volts momentarily, or the ECM was not allowed to power down correctly (retain battery voltage for 30 seconds after key OFF).	Possible no noticeable performance.
1139 651 7	Injector solenoid driver cylinder 1 - Mechanical system not responding or out of adjustment. The ECM has detected an error with the injection timing or quantity.	Possible reduced engine performance.
1141 652 7	Injector solenoid driver cylinder 2 - Mechanical system not responding or out of adjustment. The ECM has detected an error with the injection timing or quantity.	Possible reduced engine performance.
1142 653 7	Injector solenoid driver cylinder 3 - Mechanical system not responding or out of adjustment. The ECM has detected an error with the injection timing or quantity.	Possible reduced engine performance.
1143 654 7	Injector solenoid driver cylinder 4 - Mechanical system not responding or out of adjustment. The ECM has detected an error with the injection timing or quantity.	Possible reduced engine performance.
1144 655 7	Injector solenoid driver cylinder 5 - Mechanical system not responding or out of adjustment. The ECM has detected an error with the injection timing or quantity.	Possible reduced engine performance.
1145 656 7	Injector solenoid driver cylinder 6 - Mechanical system not responding or out of adjustment. The ECM has detected an error with the injection timing or quantity.	Possible reduced engine performance.
1228 27 2	Egr valve position - Data erratic, intermittent, or Incorrect. The EGR valve is unable to meet commanded position.	Possible reduced engine performance.

※ Some fault codes are not applied to this machine.

Fault code J1939 SPN J1939 FMI	Reason	Effect (only when fault code is active)
1239 2623 3	Accelerator pedal or lever position sensor 2 circuit - Voltage above normal or shorted to high source. High voltage detected at accelerator pedal position number 2 signal circuit.	The engine will operate in limp home mode.
1241 2623 4	Accelerator pedal or lever position sensor 2 circuit - Voltage below normal or shorted to low source. Low voltage detected at accelerator pedal position number 2 signal circuit.	The engine will operate in limp home mode.
1242 91 2	Accelerator pedal or lever position sensor 1 and 2 - Data erratic, intermittent, or incorrect. Accelerator position sensor number 1 and number 2 are reading different values.	The engine will only idle.
1515 91 19	Sae J1939 multiplexed accelerator pedal or lever sensor system - Received network data in error. The J1939 multiplexing controller has indicated a malfunction of the multiplexed accelerator pedal.	The engine will only idle.
1654 1323 31	Engine misfire cylinder 1- Condition exists. Engine misfire has been detected in cylinder number 1.	Possible reduced engine performance.
1655 1324 31	Engine misfire cylinder 2 - Condition exists. Engine misfire has been detected in cylinder number 2.	Possible reduced engine performance.
1656 1325 31	Engine misfire cylinder 3 - Condition exists. Engine misfire has been detected in cylinder number 3.	Possible reduced engine performance.
1657 1326 31	Engine misfire cylinder 4 - Condition exists. Engine misfire has been detected in cylinder number 4.	Possible reduced engine performance.
1658 1327 31	Engine misfire cylinder 5 - Condition exists. Engine misfire has been detected in cylinder number 5.	Possible reduced engine performance.
1659 1328 31	Engine misfire cylinder 6 - Condition exists. Engine misfire has been detected in cylinder number 6.	Possible reduced engine performance.
1668 1761 4	Aftertreatment diesel exhaust fluid tank level sensor circuit - Voltage below normal or shorted to low source. Low signal voltage detected at the aftertreatment diesel exhaust fluid tank level sensor circuit.	Possible reduced engine performance.
1669 1761 3	Aftertreatment diesel exhaust fluid tank level sensor circuit - Voltage above normal or shorted to high source. High signal voltage detected at the catalyst tank level sensor circuit.	Possible reduced engine performance.
1673 1761 1	Aftertreatment diesel exhaust fluid tank level - Data valid but below normal operating range - Most severe level. The aftertreatment diesel exhaust fluid tank level has fallen below the critical warning level.	Possible reduced engine performance.

※ Some fault codes are not applied to this machine.

Fault code J1939 SPN J1939 FMI	Reason	Effect (only when fault code is active)
1677 3031 4	Aftertreatment diesel exhaust fluid tank temperature sensor - Voltage below normal or shorted to low source. Low signal voltage detected at the diesel exhaust fluid tank temperature sensor circuit.	Possible reduced engine performance.
1678 3031 3	Aftertreatment diesel exhaust fluid tank temperature sensor - Voltage above normal or shorted to high source. High signal voltage or open circuit detected at the diesel exhaust fluid tank temperature sensor circuit.	Possible reduced engine performance.
1679 3031 2	Aftertreatment diesel exhaust fluid tank temperature - Data erratic, intermittent, or incorrect. The diesel exhaust fluid tank temperature sensor has indicated a tank temperature too high or too low for the ambient conditions.	Possible reduced engine performance.
1682 3362 31	Aftertreatment diesel exhaust fluid dosing unit input lines - Condition exists. The aftertreatment diesel exhaust fluid dosing unit is unable to prime.	Possible reduced engine performance.
1683 3363 3	Aftertreatment diesel exhaust fluid tank heater - Voltage above normal or shorted to high source. High signal voltage detected at the aftertreatment diesel exhaust fluid tank heater circuit.	Possible reduced engine performance.
1684 3363 4	Aftertreatment diesel exhaust fluid tank heater - Voltage below normal, or shorted to low source. Low signal voltage detected at the aftertreatment diesel exhaust fluid tank heater circuit.	Possible reduced engine performance.
1691 100 18	Aftertreatment diesel oxidation catalyst conversion efficiency - Data valid but below normal operating range - Moderately severe level. The temperature increase across the aftertreatment catalyst is lower than expected.	Possible frequent need for aftertreatment regeneration.
1695 3513 3	Sensor supply 5 - Voltage above normal or shorted to high source. High voltage detected at sensor supply 5 circuit in the oem harness.	the engine will operate in limp home mode.
1696 3513 4	Sensor supply 5 - Voltage below normal or shorted to low source. Low voltage detected at sensor supply number 5 circuit in the oem harness.	the engine will operate in limp home mode.
1712 3363 18	Aftertreatment diesel exhaust fluid tank heater - Data valid but below normal operating range - Moderately severe level. The aftertreatment diesel exhaust fluid tank heater is unable to thaw the frozen diesel exhaust fluid.	Possible reduced engine performance.

※ Some fault codes are not applied to this machine.

Fault code J1939 SPN J1939 FMI	Reason	Effect (only when fault code is active)
1713 3363 16	Aftertreatment diesel exhaust fluid tank heater - Data valid but above normal operating range - Moderately severe level. The diesel exhaust fluid tank heater is continuously in the on position.	None on performance.
1718 1322 31	Engine misfire for multiple cylinders - Condition exists. Engine misfire has been detected in multiple cylinder numbers.	Possible reduced engine performance.
1776 2634 3	Power relay driver circuit - Voltage above normal or shorted to high source. High voltage detected at power relay driver circuit.	Possible reduced engine performance.
1777 2634 4	Power relay driver circuit - Voltage below normal or shorted to low source. An open circuit or low voltage has been detected at the power relay circuit.	Possible reduced engine performance.
1843 101 3	Crankcase pressure circuit - Voltage above normal or shorted to high source. High signal voltage detected at the crankcase pressure circuit.	None on performance.
1844 101 4	Crankcase pressure circuit - Voltage below normal or shorted to low source. Low signal voltage detected at the crankcase pressure circuit.	None on performance.
1866 411 2	Exhaust gas recirculation valve delta pressure - Data erratic, intermittent, or incorrect. An error in the EGR delta pressure signal was detected at initial key on or the sensor failed the autozero test.	possible reduced engine performance.
1867 412 2	Engine gas recirculation temperature - Data erratic, intermittent, or incorrect. Engine misfire has been detected in multiple cylinder numbers.	Possible reduced engine performance.
1879 3251 3	Aftertreatment diesel particulate filter differential pressure sensor circuit - Voltage above normal or shorted to high source. High signal voltage detected at the aftertreatment differential pressure sensor circuit.	possible reduced engine performance.
1881 3251 4	Aftertreatment diesel particulate filter differential pressure sensor circuit - Voltage below normal or shorted to low source. Low signal voltage or open circuit detected at the aftertreatment differential pressure sensor circuit.	possible reduced engine performance.
1883 3251 2	Aftertreatment diesel particulate filter differential pressure sensor - Data erratic, intermittent, or incorrect. The aftertreatment diesel particulate filter differential pressure sensor is reading an erratic value at initial key on or during engine operation.	possible reduced engine performance.

※ Some fault codes are not applied to this machine.

Fault code J1939 SPN J1939 FMI	Reason	Effect (only when fault code is active)
1885 3216 4	Aftertreatment intake NOx sensor circuit - Voltage below normal or shorted to low source. An internal circuit error has been detected by the aftertreatment intake NOx sensor.	Possible reduced engine performance.
1887 3226 4	Aftertreatment outlet NOx sensor circuit - Voltage below normal or shorted to low source. An internal circuit error has been detected by the aftertreatment outlet NOx sensor.	Possible reduced engine performance.
1896 2791 13	EGR valve controller - Out of calibration. The EGR valve has failed the automatic calibration procedure at initial key ON.	Possible reduced engine performance.
1921 3251 0	Aftertreatment diesel particulate filter differential pressure - Data valid but above normal operating range - Moderately severe level. The soot load of the aftertreatment diesel particulate filter has exceeded the recommended limits.	Possible reduced engine performance.
1922 3251 0	Aftertreatment diesel particulate filter differential pressure - Data valid but above normal operating range - Most severe level. The soot load of the aftertreatment diesel particulate filter has exceeded the recommended limits. Engine protection derate is enabled.	Possible reduced engine performance.
1938 3597 1	Ecu power output supply voltage 1 - Data valid but below normal operational range - Moderately severe level. Low battery voltage detected by the VGT actuator.	Possible reduced engine performance.
1942 101 2	Crankcase pressure - Data erratic, intermittent, or incorrect. The ECM has detected that the crankcase pressure signal is reading an erratic value at initial key ON or during engine operation.	None on performance.
1961 2791 0	EGR valve control circuit calculated over temperature - Data valid but above normal operational range - Least severe level. High EGR valve driver temperature has been detected.	Possible reduced engine performance.
1962 641 0	VGT Actuator driver over temperature (calculated) - Data valid but above normal operating range - Least severe level. High internal VGT actuator temperature has been detected.	None on performance.
1974 101 16	Crankcase pressure - Data valid but above normal operating range - Moderately severe level. The crankcase breather filter requires maintenance.	None on performance.

※ Some fault codes are not applied to this machine.

Fault code J1939 SPN J1939 FMI	Reason	Effect (only when fault code is active)
1993 4795 31	Aftertreatment diesel particulate filter missing - Condition exists. The aftertreatment diesel particulate filter in the exhaust system is not present.	Active aftertreatment diesel particulate filter regeneration will be disabled.
2185 3512 3	Sensor supply 4 circuit - Voltage above normal, or shorted to high source. High voltage detected at 5 VDC sensor supply circuit to the accelerator pedal position sensor.	Engine will only idle.
2186 3512 4	Sensor supply 4 circuit - Voltage below normal, or shorted to low source. Low voltage detected at 5 VDC sensor supply circuit to the accelerator pedal position sensor.	Engine will only idle.
2198 641 11	VGT Actuator driver circuit - Root cause not known. Intermittent communication between the smart VGT controller and the ECM has been detected. The VGT controller is not interpreting the J1939 message from the ECM correctly.	Possible reduced engine performance.
2272 27 4	EGR Valve position circuit - Voltage below normal or shorted to low source. Low signal voltage has been detected at the EGR valve position sensor circuit	Possible reduced engine performance.
2273 411 3	Exhaust gas recirculation valve delta pressure sensor circuit - Voltage above normal or shorted to high source. High signal voltage detected at the EGR differential pressure sensor circuit.	Possible reduced engine performance.
2274 411 4	Exhaust gas recirculation valve delta pressure sensor circuit - Voltage below normal or shorted to low source. Low signal voltage detected at the EGR differential pressure sensor circuit.	Possible reduced engine performance.
2288 103 15	Turbocharger 1 speed - Data valid but above normal operating range - Least severe level. High turbocharger speed has been detected by the ECM.	Possible reduced engine performance.
2311 633 31	Electronic fuel injection control valve circuit - Condition exists. Fuel pump actuator circuit resistance too high or too low, or an intermittent connection has been detected.	Possible reduced engine performance.
2322 723 2	Engine camshaft speed / position sensor - Data erratic, intermittent, or incorrect. Camshaft engine speed sensor intermittent synchronization.	None on performance.
2349 2791 5	EGR Valve control circuit - Current below normal or open circuit. Motor terminal or motor coil open circuit has been detected by the ECM.	Possible reduced engine performance.

※ Some fault codes are not applied to this machine.

Fault code J1939 SPN J1939 FMI	Reason	Effect (only when fault code is active)
2353 2791 6	EGR Valve control circuit - Current above normal or grounded circuit. A short circuit to ground has been detected in the EGR valve motor circuit.	Possible reduced engine performance.
2372 95 16	Fuel filter differential pressure - Data valid but above normal operational range - Moderately severe level. Excessive fuel flow restriction to the high pressure fuel pump has been detected.	Possible reduced engine performance.
2373 1209 3	Exhaust gas pressure sensor circuit - Voltage above normal or shorted to high source. High signal voltage detected at the exhaust gas pressure circuit.	Possible reduced engine performance.
2374 1209 4	Exhaust gas pressure sensor circuit - Voltage below normal or shorted to low source. Low signal voltage detected at the exhaust gas pressure circuit.	Possible reduced engine performance.
2375 412 3	Exhaust gas recirculation temperature sensor circuit - Voltage above normal or shorted to high source. High signal voltage detected at EGR temperature circuit.	Possible reduced engine performance.
2376 412 4	Exhaust gas recirculation temperature sensor circuit - Voltage below normal or shorted to low source. Low signal voltage detected at EGR temperature circuit.	Possible reduced engine performance.
2377 647 3	Fan control circuit - Voltage above normal, or shorted to high source. Open circuit or high voltage detected at the fan control circuit.	The fan can stay on continuously or not run at all.
2387 641 7	VGT Actuator driver circuit (motor) - Mechanical system not responding or out of adjustment. The smart VGT controller has detected incorrect stop limits, or the VGT is unable to move to the closed position.	Possible reduced engine performance.
2398 171 2	Ambient air temperature - Data erratic, intermittent, or incorrect. The ambient air temperature sensor is reading an erratic value.	Possible reduced engine performance.
2448 111 17	Coolant level - Data valid but below normal operational range - Least severe level. Low engine coolant level detected.	none on performance.
2449 641 13	Vgt actuator controller - Out of calibration. The VGT actuator has been installed incorrectly.	Possible reduced engine performance.
2468 102 3	Engine crankshaft speed/position - Data valid but above normal operating range - Moderately severe level. The engine speed has exceeded a critical limit.	Engine will be shut down.
2554 1209 2	Exhaust gas pressure - Data erratic, intermittent or incorrect. The exhaust gas pressure sensor is reading an erratic value.	possible reduced engine performance.

※ Some fault codes are not applied to this machine.

Fault code J1939 SPN J1939 FMI	Reason	Effect (only when fault code is active)
2555 729 3	Intake air heater 1 circuit - Voltage above normal, or shorted to high source. High voltage detected at the intake air heater signal circuit.	The intake air heaters may be ON or OFF all the time.
2556 729 4	Intake air heater 1 circuit - Voltage below normal, or shorted to low source. Low voltage detected at the intake air heater signal circuit.	The intake air heaters may be ON or OFF all the time.
2634 641 12	VGT Actuator controller - Bad intelligent device or component. An internal error has been detected by the smart VGT controller.	Possible reduced engine performance.
2636 641 9	VGT Actuator driver circuit - abnormal update rate. No communications on the J1939 data link between the engine ECM and the smart VGT controller.	Possible reduced engine performance.
2638 5298 17	Aftertreatment diesel oxidation catalyst conversion efficiency - Data valid but below normal operating range - Least severe level. The temperature increase across the aftertreatment diesel oxidation catalyst is lower than expected.	Possible frequent need for aftertreatment regeneration.
2639 3251 15	Aftertreatment diesel particulate filter differential pressure - Data valid but above normal operating range - Least severe level. The soot load of the aftertreatment diesel particulate filter has exceeded the recommended limits.	Possible reduced engine performance.
2646 110 32	Engine coolant temperature - Condition exists. The EGR valve was closed to reduce engine coolant temperature.	Possible reduced engine performance.
2718 520325 31	Brake switch and accelerator pedal position incompatible - Condition exists. The ECM has detected the brake pedal and accelerator pedal were depressed simultaneously.	The engine will operate in limp home mode.
2771 3226 9	Aftertreatment outlet NOx sensor - Abnormal update rate. No communications or an invalid data transfer rate detected on the J1939 data link between the ECM and the aftertreatment outlet NOx sensor.	Possible reduced engine performance.
2777 3703 31	Particulate trap active regeneration inhibited due to inhibit switch - Condition exists. Regeneration of the diesel particulate filter has been prevented due to the permit switch being disabled.	Possible frequent need for aftertreatment regeneration.
2961 412 15	Exhaust gas recirculation temperature - Data valid but above normal operational range - Least severe level. EGR temperature has exceeded the engine protection limit.	Possible reduced engine performance.
2962 412 16	Exhaust gas recirculation temperature - Data valid but above normal operational range - Moderately severe level. EGR temperature has exceeded the engine protection limit.	Possible reduced engine performance.

※ Some fault codes are not applied to this machine.

Fault code J1939 SPN J1939 FMI	Reason	Effect (only when fault code is active)
2963 110 15	Engine coolant temperature - Data valid but above normal operational range - Least severe level. Engine coolant temperature is above the engine protection warning limit.	Progressive power and/or speed derate increasing in severity from time of alert. If the Engine protection shutdown feature is enabled, the engine will shut down 30 seconds after the red STOP lamps starts flashing.
2964 105 15	Intake manifold 1 temperature - Data valid but above normal operational range - Least severe level. Intake manifold air temperature signal indicates intake manifold air temperature is above engine protection warning limit.	Progressive power and/or speed derate increasing in severity from time of alert. If the Engine protection shutdown feature is enabled, the engine will shut down 30 seconds after the red STOP lamps starts flashing.
2973 102 2	Intake manifold 1 pressure - Data erratic, intermittent, or incorrect. The intake manifold pressure sensor is reading an erratic value.	Possible reduced engine performance.
2976 3361 2	Aftertreatment diesel exhaust fluid dosing unit temperature - Data erratic, intermittent, or incorrect. An internal error has been detected in the aftertreatment diesel exhaust fluid dosing unit.	Possible reduced engine performance.
3133 3610 3	Aftertreatment diesel particulate filter outlet pressure sensor circuit - Voltage above normal, or shorted to high source. High signal voltage detected at the aftertreatment diesel particulate filter outlet pressure sensor circuit.	Possible reduced engine performance.
3134 3610 4	Aftertreatment diesel particulate filter outlet pressure sensor circuit - Voltage below normal, or shorted to low source. Low signal voltage detected at the aftertreatment diesel particulate filter outlet pressure sensor circuit.	Possible reduced engine performance.
3135 3610 2	Aftertreatment diesel particulate filter outlet pressure - Data erratic, intermittent or incorrect. The aftertreatment diesel particulate filter outlet pressure sensor is reading an erratic value at initial key ON or during engine operation.	Possible reduced engine performance.
3146 4363 3	Aftertreatment SCR outlet temperature sensor circuit - Voltage above normal or shorted to high source. High signal voltage detected at the SCR outlet temperature sensor circuit.	Possible reduced engine performance.
3147 4363 4	Aftertreatment SCR outlet temperature sensor circuit - Voltage below normal or shorted to low source. Low signal voltage detected at the SCR outlet temperature sensor circuit.	Possible reduced engine performance.
3148 4363 2	Aftertreatment SCR outlet temperature sensor - Data erratic, intermittent, or incorrect. The SCR outlet temperature sensor is not changing with engine operating conditions.	Possible reduced engine performance.
3151 4794 31	Aftertreatment SCR catalyst system missing - Condition exists. The aftertreatment SCR catalyst in the exhaust system is not present.	Possible reduced engine performance.

※ Some fault codes are not applied to this machine.

Fault code J1939 SPN J1939 FMI	Reason	Effect (only when fault code is active)
3165 4363 0	Aftertreatment SCR outlet temperature - Data valid but above normal operational range - Most severe level. The SCR outlet temperature sensor reading has exceeded the maximum engine protection temperature limit.	Possible reduced engine performance.
3168 3936 16	Aftertreatment diesel particulate filter system - Data valid but above normal operating range - Moderately severe level. The system has detected a malfunction in the filtering capability of the aftertreatment diesel particulate filter.	None on performance.
3186 1623 9	Tachograph output shaft speed - Abnormal update rate. No communication or an invalid data transfer rate has been detected on the J1939 data link between the ECM and the tachograph output shaft speed sensor.	None on performance.
3213 1623 19	Tachograph output shaft speed - Received network data in error. The J1939 multiplexing controller has indicated a malfunction of the tachograph output shaft speed sensor.	None on performance.
3228 3216 2	Aftertreatment Intake NOx sensor - Data erratic, intermittent, or incorrect. An incorrect NOx sensor reading has been detected by the aftertreatment intake NOx sensor.	Possible reduced engine performance.
3232 3216 9	Aftertreatment Intake NOx sensor - Abnormal update rate. No communication or an invalid data transfer rate has been detected on the J1939 data link between the ECM and the aftertreatment intake NOx sensor.	Possible reduced engine performance.
3235 4363 16	Aftertreatment SCR outlet temperature - Data valid but above normal operating range - Moderately severe level. The SCR outlet temperature sensor reading has exceeded the maximum temperature limit.	Possible reduced engine performance.
3237 4340 3	Aftertreatment diesel exhaust fluid line heater 1 circuit - Voltage above normal or shorted to high source. High signal voltage detected at the diesel exhaust fluid line heater 1 circuit.	Possible reduced engine performance.
3238 4340 4	Aftertreatment diesel exhaust fluid line heater 1 circuit - Voltage below normal, or shorted to low source. Low signal voltage detected at the diesel exhaust fluid line heater 1 circuit.	Possible reduced engine performance.
3239 4342 3	Aftertreatment diesel exhaust fluid line heater 2 circuit - Voltage above normal or shorted to high source. High signal voltage detected at the diesel exhaust fluid line heater 2 circuit.	Possible reduced engine performance.
3241 4342 4	Aftertreatment diesel exhaust fluid line heater 2 circuit - Voltage below normal, or shorted to low source. Low signal voltage detected at the diesel exhaust fluid line heater 2 circuit.	Possible reduced engine performance.

※ Some fault codes are not applied to this machine.

Fault code J1939 SPN J1939 FMI	Reason	Effect (only when fault code is active)
3242 3363 7	Aftertreatment diesel exhaust fluid tank heater - Mechanical system not responding or out of adjustment. The aftertreatment diesel exhaust fluid temperature did not increase when the aftertreatment diesel exhaust fluid tank heater was commanded ON.	Possible reduced engine performance.
3243 3060 18	Engine cooling system monitor - Data valid but below normal operating range - Moderately severe level. The engine is not warming up as expected.	None on performance.
3251 4765 16	Aftertreatment diesel oxidation catalyst intake temperature - Data valid but above normal operating range - Moderately severe level. The diesel oxidation catalyst intake temperature sensor reading has exceeded the maximum temperature limit.	Progressive power and/or speed derate increasing in severity from time of alert. If the Engine protection shutdown feature is enabled, the engine will shut down 30 seconds after the red STOP lamps starts flashing.
3253 3242 16	Aftertreatment diesel particulate filter intake temperature - Data valid but above normal operating range - Moderately severe level. The aftertreatment diesel particulate filter intake temperature sensor reading has exceeded the maximum engine protection temperature limit.	Progressive power and/or speed derate increasing in severity from time of alert. If the Engine protection shutdown feature is enabled, the engine will shut down 30 seconds after the red STOP lamps starts flashing.
3254 3242 15	Aftertreatment diesel particulate filter intake temperature - Data valid but above normal operating range - Least severe level. The aftertreatment diesel particulate filter intake temperature sensor reading has exceeded the maximum engine protection temperature limit.	Possible reduced engine performance.
3255 3246 16	Aftertreatment diesel particulate filter outlet temperature - Data valid but above normal operating range - Moderately severe level. The aftertreatment diesel particulate filter outlet temperature sensor reading has exceeded the maximum engine protection temperature limit.	Progressive power and/or speed derate increasing in severity from time of alert. If the engine protection shutdown feature is enabled, the engine will shut down 30 seconds after the red STOP lamps starts flashing.
3256 3246 15	Aftertreatment diesel particulate filter outlet temperature - Data valid but above normal operating range - Least severe level. The aftertreatment diesel particulate filter outlet temperature sensor reading has exceeded the maximum engine protection temperature limit.	Possible reduced engine performance.
3258 4340 5	Aftertreatment diesel exhaust fluid line heater 1 circuit - Current below normal or open circuit. Open circuit detected in the diesel exhaust fluid line heater 1.	Possible reduced engine performance.
3261 4342 5	Aftertreatment diesel exhaust fluid line heater 2 circuit - Current below normal or open circuit. Open circuit detected in the diesel exhaust fluid line heater 2.	Possible reduced engine performance.

※ Some fault codes are not applied to this machine.

Fault code J1939 SPN J1939 FMI	Reason	Effect (only when fault code is active)
3311 3242 0	Aftertreatment diesel particulate filter intake temperature - Data valid but above normal operating range - Most severe level. The aftertreatment diesel particulate filter intake temperature sensor reading has exceeded the maximum engine protection temperature limit.	Progressive power and/or speed derate increasing in severity from time of alert. If the engine protection shutdown feature is enabled, the engine will shut down 30 seconds after the red STOP lamps starts flashing.
3312 3246 0	Aftertreatment diesel particulate filter outlet temperature - Data valid but above normal operating range - Most severe level. The aftertreatment diesel particulate filter outlet temperature sensor reading has exceeded the maximum engine protection temperature limit.	Progressive power and/or speed derate increasing in severity from time of alert. If the engine protection shutdown feature is enabled, the engine will shut down 30 seconds after the red STOP lamps starts flashing.
3313 4765 4	Aftertreatment diesel oxidation catalyst intake temperature sensor circuit - Voltage below normal or shorted to low source. Low signal voltage detected at the catalyst intake sensor circuit.	Possible reduced engine performance.
3314 4765 3	Aftertreatment diesel oxidation catalyst intake temperature sensor circuit - Voltage above normal or shorted to high source. High signal voltage detected at the catalyst intake temperature sensor circuit.	Possible reduced engine performance.
3315 4765 2	Aftertreatment diesel oxidation catalyst intake temperature - Data erratic, intermittent, or incorrect. The aftertreatment diesel oxidation catalyst intake temperature sensor is not changing with engine operating conditions.	Possible reduced engine performance.
3316 3242 4	Aftertreatment diesel particulate filter intake temperature sensor circuit - Voltage below normal or shorted to low source. Low signal voltage detected at the aftertreatment diesel particulate filter intake temperature sensor circuit.	Possible reduced engine performance.
3317 3242 3	Aftertreatment diesel particulate filter intake temperature sensor circuit - Voltage above normal or shorted to high source. High signal voltage or open circuit detected at the aftertreatment diesel particulate filter intake temperature sensor circuit.	Possible reduced engine performance.
3318 3242 2	Aftertreatment diesel particulate filter intake temperature - Data erratic, intermittent, or incorrect. The aftertreatment diesel particulate filter intake temperature is not changing with engine operating conditions.	Possible reduced engine performance.
3319 3246 3	Aftertreatment diesel particulate filter outlet temperature sensor circuit - Voltage above normal or shorted to high source. High signal voltage or open circuit detected at the aftertreatment diesel particulate filter outlet temperature sensor circuit.	Possible reduced engine performance.

※ Some fault codes are not applied to this machine.

Fault code J1939 SPN J1939 FMI	Reason	Effect (only when fault code is active)
3321 3246 4	Aftertreatment diesel particulate filter outlet temperature sensor circuit - Voltage below normal or shorted to low source. Low signal voltage detected at the aftertreatment diesel particulate filter outlet temperature sensor circuit.	Possible reduced engine performance.
3322 3246 2	Aftertreatment diesel particulate filter outlet temperature - Data erratic, intermittent, or incorrect. The aftertreatment diesel particulate filter outlet temperature is not changing with engine operating conditions.	Possible reduced engine performance.
3326 91 9	SAE J1939 Multiplexed accelerator pedal or lever sensor system - Abnormal update rate. The ECM expected information from a multiplexed accelerator pedal or lever sensor but did not receive it soon enough or did not receive it at all.	Engine will only idle.
3328 191 9	Transmission output shaft speed - Abnormal update rate. No communication or an invalid data transfer rate has been detected on the J1939 data link between the ECM and the transmission output shaft speed sensor.	None on performance.
3342 4752 18	Engine exhaust gas recirculation cooler efficiency - Data valid but below normal operating range - Moderately severe level. The EGR cooler is not cooling the recirculated exhaust gas sufficiently.	None on performance.
3343 5285 18	Engine charge-air cooler efficiency - Data valid but below normal operating range - Moderately severe level. The engine charge air cooler is not cooling the intake air flow sufficiently.	None on performance.
3361 102 10	Intake manifold 1 pressure - Abnormal rate of change. The VGT position reading is stuck.	Possible reduced engine performance.
3366 111 18	Coolant level - Data valid but below normal operating range - Moderately severe level. Very low engine coolant level detected.	None on performance.
3374 1818 31	Roll over protection brake control active - Condition exists. The ECM received a message from the anti-lock braking (ABS) controller, inhibiting cruise control operation.	Cruise control could possibly not operate.
3375 5397 31	Aftertreatment diesel particulate filter regeneration too frequent - Condition exists. The system has detected the need for an active regeneration has occurred too soon following the last active regeneration.	None on performance.
3376 5319 31	Aftertreatment diesel particulate filter incomplete regeneration - Condition exists. The system has detected that the aftertreatment diesel particulate filter differential pressure is too high following an active regeneration.	Possible frequent need for aftertreatment regeneration.

※ Some fault codes are not applied to this machine.

Fault code J1939 SPN J1939 FMI	Reason	Effect (only when fault code is active)
3382 3058 18	Engine exhaust gas recirculation (EGR) system - Data valid but below normal operating range - Moderately severe level. Measured egr flow is lower than commanded.	Possible reduced engine performance.
3383 3058 16	Engine exhaust gas recirculation (EGR) system - Data valid but above normal operating range - Moderately severe Level. Measured EGR flow is higher than commanded.	Possible reduced engine performance.
3394 4766 18	Aftertreatment 1 diesel oxidation catalyst outlet gas temperature - Data valid but below normal operating range - Moderately severe level. The diesel oxidation catalyst outlet Temperature is below the operating limit	Possible frequent need for aftertreatment regeneration.
3396 3750 31	Diesel particulate filter 1 conditions not met for active regeneration - Condition exists. The aftertreatment temperatures are not warm enough for aftertreatment injection.	Possible frequent need for aftertreatment regeneration.
3418 191 19	Transmission output shaft speed - Received network data in error. The J1939 multiplexing controller has indicated a malfunction of the transmission output shaft speed sensor.	None on performance.
3422 4344 3	Aftertreatment diesel exhaust fluid line heater 3 circuit - Voltage above normal or shorted to high source. High signal voltage detected at the diesel exhaust fluid line heater 3 circuit.	Possible reduced engine performance.
3423 4344 4	Aftertreatment diesel exhaust fluid line heater 3 circuit - Voltage below normal, or shorted to low source. Low signal voltage detected at the diesel exhaust fluid line heater 3 circuit.	Possible reduced engine performance.
3425 4344 5	Aftertreatment diesel exhaust fluid line heater 3 circuit - Current below normal or open circuit. Open circuit detected in the diesel exhaust fluid line heater 3.	Possible reduced engine performance.
3488 563 9	Anti-lock braking (ABS) controller - Abnormal update rate. No communication or an invalid data transfer rate has been detected on the J1939 data link between the ECM and the anti-lock braking (ABS) controller.	None on performance.
3492 251 10	Real time clock - Abnormal rate of change. The real time clock indicates a stuck engine off timer.	None on performance.
3494 1081 7	Engine wait to start lamp - Mechanical system not responding or out of adjustment. Wait to Start lamp has malfunction.	None on performance.
3497 1761 17	Aftertreatment diesel exhaust fluid tank level - Data valid but below normal operating range - Least severe level. The aftertreatment diesel exhaust fluid tank level is low.	None on performance.

※ Some fault codes are not applied to this machine.

Fault code J1939 SPN J1939 FMI	Reason	Effect (only when fault code is active)
3498 1761 18	Aftertreatment diesel exhaust fluid tank level - Data valid but below normal operating range - Moderately severe level. The aftertreatment diesel exhaust fluid tank level is very low.	None on performance.
3525 84 19	Wheel-based vehicle speed - Received network data in error. The J1939 multiplexing controller has indicated a malfunction of the wheel-based vehicle speed sensor.	Engine speed limited to maximum engine speed without VSS parameter value. Cruise control, gear-down protection, and road speed governor will not work.
3526 84 9	Wheel-Based vehicle speed - Abnormal update rate. No communication or an invalid data transfer rate has been detected on the J1939 data link between the ECM and the wheel-based vehicle speed sensor.	Engine speed limited to maximum engine speed without VSS parameter value. Cruise control, gear-down protection, and road speed governor will not work.
3527 558 19	Accelerator pedal or lever idle validation switch - Received network data in error. The J1939 multiplexing controller has indicated a malfunction of the accelerator pedal or lever idle validation switch.	The engine will only idle.
3528 558 9	Accelerator pedal or lever idle validation switch - Abnormal update rate. No communication or an invalid data transfer rate has been detected on the J1939 data link between the ECM and the accelerator pedal or lever idle validation switch.	Engine will only idle.
3531 171 9	Ambient air temperature - Abnormal update rate. No communication or an invalid data transfer rate has been detected on the J1939 data link between the ECM and the ambient air temperature sensor.	Possible reduced engine performance.
3532 171 19	Ambient air temperature - Received network data in error. The J1939 multiplexing controller has indicated a malfunction of the ambient air temperature sensor.	Possible reduced engine performance.
3539 51 3	Engine intake throttle actuator position sensor circuit - Voltage above normal, or shorted to high source. High signal voltage detected at the engine intake air throttle position sensor circuit.	Possible reduced engine performance.
3541 51 4	Engine intake throttle actuator position sensor circuit - Voltage below normal, or shorted to low source. Low signal voltage detected at the engine intake air throttle position sensor circuit.	Possible reduced engine performance.
3542 51 2	Engine intake throttle actuator position sensor - Data erratic, intermittent or incorrect. The engine intake air throttle position feedback is erratic or incorrect.	Possible reduced engine performance.
3545 3226 10	Aftertreatment outlet NOx sensor circuit - Abnormal rate of change. The aftertreatment outlet NOx sensor reading is not valid.	None on performance.

※ Some fault codes are not applied to this machine.

Fault code J1939 SPN J1939 FMI	Reason	Effect (only when fault code is active)
3547 4096 31	Aftertreatment diesel exhaust fluid tank empty - Condition exists. The diesel exhaust fluid tank is empty.	Possible reduced engine performance.
3555 1081 9	Engine wait to start lamp - Abnormal update rate. A loss of communication has been detected.	None on performance.
3556 1081 19	Engine wait to start lamp - Received network data in error. The ECM received an invalid signal on the SAE J1939 datalink.	None on performance.
3558 3361 3	Aftertreatment diesel exhaust fluid dosing unit - Voltage above normal or shorted to high source. High signal voltage detected at the aftertreatment diesel exhaust fluid dosing unit.	Possible reduced engine performance.
3559 3361 4	Aftertreatment diesel exhaust fluid dosing unit - Voltage below normal or shorted to low source. Low signal voltage detected at the aftertreatment diesel exhaust fluid dosing unit.	Possible reduced engine performance.
3562 5491 3	Aftertreatment diesel exhaust fluid line heater relay - Voltage above normal or shorted to high source. High signal voltage detected at the diesel exhaust fluid line heater relay.	Possible reduced engine performance.
3563 5491 4	Aftertreatment diesel exhaust fluid line heater relay - Voltage below normal or shorted to low source. Low signal voltage detected at the diesel exhaust fluid line heater relay.	Possible reduced engine performance.
3567 5394 5	Aftertreatment diesel exhaust fluid dosing valve - Current below normal or open circuit. A circuit error has been detected in the aftertreatment diesel exhaust fluid dosing valve circuit.	Possible reduced engine performance.
3568 5394 7	Aftertreatment diesel exhaust fluid (DEF) Dosing valve - Mechanical system not responding or out of adjustment. A mechanical malfunction has been detected in the DEF dosing valve.	Possible reduced engine performance.
3571 4334 3	Aftertreatment diesel exhaust fluid pressure sensor - Voltage above normal or shorted to high source. High signal voltage detected at the aftertreatment diesel exhaust fluid pressure sensor circuit.	Possible reduced engine performance.
3572 4334 4	Aftertreatment diesel exhaust fluid pressure sensor - Voltage below normal or shorted to low source. Low signal voltage detected at the diesel exhaust fluid pressure sensor circuit.	Possible reduced engine performance.
3574 4334 18	Aftertreatment diesel exhaust fluid pressure sensor - Data valid but below normal operating range - Moderately severe level. Low diesel exhaust fluid pressure has been detected in the dosing unit.	Possible reduced engine performance.

※ Some fault codes are not applied to this machine.

Fault code J1939 SPN J1939 FMI	Reason	Effect (only when fault code is active)
3575 4334 16	Aftertreatment diesel exhaust fluid pressure sensor - Data valid but above normal operating range - Moderately severe level. The diesel exhaust fluid dosing unit has detected a blockage in the diesel exhaust fluid return flow.	Possible reduced engine performance.
3577 4376 3	Aftertreatment diesel exhaust fluid return valve - Voltage above normal or shorted to high source. High signal voltage detected at the aftertreatment diesel exhaust fluid return valve.	Possible reduced engine performance.
3578 4376 4	Aftertreatment diesel exhaust fluid return valve - Voltage below normal, or shorted to low source. Low signal voltage detected at the diesel exhaust fluid return valve.	Possible reduced engine performance.
3582 4364 18	Aftertreatment SCR catalyst conversion efficiency - Data valid but below normal operating range - Moderately severe level. NOx conversion across the SCR catalyst is too low.	Possible reduced engine performance.
3583 5031 10	Aftertreatment outlet NOx sensor heater - Abnormal rate of change. The aftertreatment outlet NOx sensor heater is unable to maintain its normal operating temperature.	None on performance.
3596 4334 2	Aftertreatment diesel exhaust fluid pressure sensor - Data erratic, intermittent, or incorrect. The diesel exhaust fluid pressure sensor has reported a reading too high or low for the operating conditions.	Possible reduced engine performance.
3649 5024 10	Aftertreatment Intake NOx sensor heater - Abnormal rate of change. The aftertreatment intake NOx sensor heater is unable to maintain its normal operating temperature.	None on performance.
3681 3228 2	Aftertreatment outlet NOx sensor power supply - Data erratic, intermittent, or incorrect. The aftertreatment outlet NOx sensor indicates that the power supply to the sensor is incorrect.	None on performance.
3682 3218 2	Aftertreatment Intake NOx sensor power supply - Data erratic, intermittent or incorrect. The aftertreatment intake NOx sensor indicates that the power supply to the sensor is incorrect.	None on performance.
3697 630 12	Engine control module calibration memory - Bad intelligent device or component. Error internal to the ECM related to engine software failures.	Engine may not start or may be difficult to start.
3712 5246 0	Aftertreatment SCR operator inducement - Data valid but above normal operational range - Most severe level. Critical SCR related fault codes have been active for an extended period of time and require immediate attention.	Vehicle speed will be limited to 8 km [5 miles] per hour.

※ Some fault codes are not applied to this machine.

Fault code J1939 SPN J1939 FMI	Reason	Effect (only when fault code is active)
3714 1569 31	Engine protection torque derate - Condition exists. Critical fault codes related to engine operation are active.	Possible reduced engine performance.
3715 188 16	Engine speed at idle - Data valid but below normal operating range - Moderately severe level. The engine speed at idle has exceeded the governed idle speed.	Possible reduced engine performance.
3716 188 18	Engine speed at idle - Data valid but below normal operational range - Moderately severe level. Engine is not maintaining the governed idle speed.	None on performance.
3717 3226 13	Aftertreatment outlet NOx sensor - Out of calibration. A calibration mismatch between the aftertreatment outlet NOx sensor and the ECM has been detected.	None on performance.
3718 3216 13	Aftertreatment intake NOx - Out of calibration. A calibration mismatch between the aftertreatment intake NOx sensor and the ECM has been detected.	None on performance.
3724 168 17	Battery 1 voltage - Data valid but below normal operating range - Least severe level. Low voltage to the EGR valve device driver has been detected.	Possible reduced engine performance.
3725 3216 10	Aftertreatment Intake NOx sensor - Abnormal rate of change. The aftertreatment intake NOx sensor reading is not valid.	None on performance.
3727 5571 7	High pressure common rail fuel pressure relief valve - Mechanical system not responding or out of adjustment. The fuel rail high-pressure relief valve has opened at a lower than expected pressure.	Possible reduced engine performance.
3737 1675 31	Engine starter mode overcrank protection - Condition exists. The starter motor has been temporarily disabled in order to prevent starter damage.	Starter operation is prohibited until the starter motor has adequately cooled.
3741 5571 0	High pressure common rail fuel pressure relief valve - Data valid but above normal operational range - Most severe level. The fuel rail pressure relief valve has opened due to high fuel rail pressure.	Engine may run rough, may stop running, may not start, or may be difficult to start.
3749 3226 20	Aftertreatment outlet NOx sensor - Data not rational - Drifted high. An offset in the outlet NOx sensor reading has been detected.	None on performance.
3838 2978 9	Estimated engine parasitic losses - Percent torque - Abnormal update rate. A loss of communication has been detected.	None on performance.
3843 5603 9	Cruise control disable command - Abnormal update rate. No communication or an invalid data transfer rate has been detected on the J1939 data link between the ECM and the cruise control.	None on performance.

※ Some fault codes are not applied to this machine.

Fault code J1939 SPN J1939 FMI	Reason	Effect (only when fault code is active)
3844 5605 31	Cruise control pause command - Condition exists. The adaptive cruise control has dropped out and must be manually engaged.	Cruise control could possibly not operate.
3845 5603 31	Cruise control disable command - Condition exists. The adaptive cruise control has dropped out and must be manually engaged.	Cruise control could possibly not operate.
3899 5848 4	Aftertreatment 1 SCR Intermediate NH3 sensor - Voltage below normal, or shorted to low source. A circuit error has been detected in the NH3 sensor.	None on performance.
3911 5848 9	Aftertreatment SCR Intermediate NH3 sensor - Abnormal update rate. Loss of communication with the aftertreatment SCR intermediate NH3 sensor.	Possible reduced engine performance.
3912 5853 10	Aftertreatment SCR Intermediate NH3 sensor heater - Abnormal rate of change. A malfunction of the aftertreatment SCR intermediate NH3 sensor heater has been detected.	Possible reduced engine performance.
3932 5851 16	Aftertreatment SCR Intermediate NH3 gas sensor power supply - Data valid but above normal operating range - Moderately severe level. High battery voltage supply detected at the aftertreatment SCR intermediate NH3 sensor.	Possible reduced engine performance.
3933 5851 18	Aftertreatment SCR Intermediate NH3 gas sensor power supply - Data valid but below normal operating range - Moderately severe level. Low battery voltage supply detected at the aftertreatment SCR intermediate NH3 sensor.	Possible reduced engine performance.
3934 5851 2	Aftertreatment SCR Intermediate NH3 gas sensor power supply - Data erratic, intermittent or incorrect. Intermittent battery voltage supply detected at the aftertreatment SCR intermediate NH3 sensor.	Possible reduced engine performance.
3935 5848 13	Aftertreatment SCR Intermediate NH3 sensor - Out of calibration. Incorrect trim resistance has been detected in the aftertreatment SCR intermediate NH3 sensor.	Possible reduced engine performance.
3936 5848 12	Aftertreatment SCR Intermediate NH3 sensor - Bad intelligent device or component. An internal error of the aftertreatment SCR intermediate NH3 sensor has been detected.	Possible reduced engine performance.
3937 5848 10	Aftertreatment 1 SCR Intermediate NH3 sensor - Abnormal rate of change. The aftertreatment SCR intermediate NH3 sensor reading is NOT valid.	Possible reduced engine performance.

※ Some fault codes are not applied to this machine.

Fault code J1939 SPN J1939 FMI	Reason	Effect (only when fault code is active)
4149 2623 8	Accelerator pedal or lever position sensor 2 circuit frequency - Abnormal frequency or pulse width or period. The accelerator pedal position sensor reading is out of range.	The engine will operate in Limp Home mode.
4151 5742 9	Aftertreatment diesel particulate filter temperature sensor module - Abnormal update rate. No communications on the J1939 data link between the ECM and the aftertreatment diesel particulate filter temperature sensor module.	Possible reduced engine performance.
4152 5743 9	Aftertreatment selective catalytic reduction temperature sensor module - Abnormal update rate. No communications on the J1939 data link between the ECM and the aftertreatment SCR temperature sensor module.	Possible reduced engine performance.
4155 5746 3	Aftertreatment 1 diesel exhaust fluid dosing unit heater relay - Voltage above normal, or shorted to high source. High signal voltage detected at the aftertreatment diesel exhaust fluid dosing unit heater relay circuit.	Possible reduced engine performance.
4156 5746 4	Aftertreatment 1 diesel exhaust fluid dosing unit heater relay - Voltage below normal, or shorted to low source. Low signal voltage detected at the aftertreatment diesel exhaust fluid dosing unit heater relay circuit.	Possible reduced engine performance.
4157 4376 7	Aftertreatment diesel exhaust fluid return valve - Mechanical system not responding or out of adjustment. A stuck aftertreatment diesel exhaust fluid return valve has been detected.	None on performance.
4158 5742 12	Aftertreatment diesel particulate filter temperature sensor module - Bad intelligent device or component. An internal error has been detected in the aftertreatment diesel particulate filter temperature sensor module.	Possible reduced engine performance.
4159 5743 12	Aftertreatment selective catalytic reduction temperature sensor module - Bad intelligent device or component. An internal error has been detected in the aftertreatment SCR temperature sensor module.	Possible reduced engine performance.
4161 5742 3	Aftertreatment diesel particulate filter temperature sensor module - Voltage above normal, or shorted to high source. High battery supply voltage detected at the aftertreatment diesel particulate filter temperature sensor module.	Possible reduced engine performance.
4162 5742 4	Aftertreatment diesel particulate filter temperature sensor module - Voltage below normal, or shorted to low source. Low battery supply voltage detected at the aftertreatment diesel particulate filter temperature sensor module.	Possible reduced engine performance.

※ Some fault codes are not applied to this machine.

Fault code J1939 SPN J1939 FMI	Reason	Effect (only when fault code is active)
4163 5742 16	Aftertreatment diesel particulate filter temperature sensor module- Data valid but above normal operating range - Moderately severe level. High internal temperature detected in the aftertreatment diesel particulate filter temperature sensor module.	Possible reduced engine performance.
4164 5743 3	Aftertreatment selective catalytic reduction temperature sensor module - Voltage above normal, or shorted to high source. High battery supply voltage detected at the aftertreatment SCR temperature sensor module.	Possible reduced engine performance.
4165 5743 4	Aftertreatment selective catalytic reduction temperature sensor module - Voltage below normal, or shorted to low source. Low battery supply voltage detected at the aftertreatment SCR temperature sensor module.	Possible reduced engine performance.
4166 5743 16	Aftertreatment selective catalytic reduction temperature sensor module - Data valid but above normal operating range - Moderately severe level. High internal temperature detected in the aftertreatment SCR temperature sensor module.	Possible reduced engine performance.
4168 5745 3	Aftertreatment diesel exhaust fluid dosing unit heater - Voltage above normal, or shorted to high source. The aftertreatment diesel exhaust fluid dosing unit heater is detected to be stuck on.	None on performance.
4169 5745 5	Aftertreatment diesel exhaust fluid dosing unit heater - Voltage below normal, or shorted to low source. The aftertreatment diesel exhaust fluid dosing unit heater is detected to be stuck off.	Possible reduced engine performance.
4171 5745 18	Aftertreatment diesel exhaust fluid dosing unit heater - Data valid but below normal operating range - Moderately severe level. The aftertreatment diesel exhaust fluid dosing unit failed to thaw.	Possible reduced engine performance.
4213 3695 2	Aftertreatment diesel particulate filter regeneration inhibit switch - Data erratic, intermittent or incorrect. The diesel particulate filter regeneration permit switch is stuck in the OFF or INHIBIT position.	Possible frequent need for aftertreatment regeneration.
4215 563 31	Anti-lock braking (ABS) Active - Condition exists. Cruise control was paused due to an anti-wheel slip message from the ABS controller.	Adaptive cruise control will not operate. Standard cruise control may not operate.
4244 4337 2	Aftertreatment diesel exhaust fluid dosing temperature - Data erratic, intermittent or incorrect. The aftertreatment diesel exhaust fluid dosing temperature is irrational.	None on performance.

※ Some fault codes are not applied to this machine.

Fault code J1939 SPN J1939 FMI	Reason	Effect (only when fault code is active)
4245 5798 2	Aftertreatment diesel exhaust fluid dosing unit heater temperature - Data erratic, intermittent or incorrect. The aftertreatment diesel exhaust fluid dosing unit heater temperature is irrational.	None on performance.
4249 4337 10	Aftertreatment diesel exhaust fluid dosing temperature - Abnormal rate of change. The aftertreatment diesel exhaust fluid dosing unit temperature is stuck.	None on performance.
4251 5798 10	Aftertreatment 1 diesel exhaust fluid dosing unit heater temperature - Abnormal rate of change. The aftertreatment diesel exhaust fluid dosing unit heater temperature sensor reading is stuck.	None on performance.
4252 1081 31	Engine wait to start lamp - Condition exists. The received signal does not match the commanded signal.	None on performance.
4259 5742 11	Aftertreatment diesel particulate filter temperature sensor module - Root cause not known. Intermittent battery voltage supply detected at the aftertreatment diesel particulate filter temperature sensor module.	Possible reduced engine performance.
4261 5743 11	Aftertreatment selective catalytic reduction temperature sensor module - Root cause not known. Intermittent battery voltage supply detected at the aftertreatment SCR temperature sensor module.	Possible reduced engine performance.
4279 5848 21	Aftertreatment 1 SCR Intermediate NH3 - Data not rational - Drifted low. An in range low failure has been detected.	Possible reduced engine performance.
4281 5848 2	Aftertreatment SCR Intermediate NH3 - Data erratic, intermittent or incorrect. The aftertreatment SCR intermediate NH3 sensor reading is stuck.	None on performance.
4284 5793 9	Desired engine fueling state - Abnormal update rate. A valid message from the transmission ECU has NOT been received.	Engine may not start or may be difficult to start.
4289 91 8	Accelerator pedal or lever position sensor 1 circuit frequency - Abnormal frequency or pulse width or period. The accelerator pedal position sensor reading is out of range.	The engine will operate in limp home mode.
4452 520668 31	Aftertreatment outlet NOx sensor closed loop operation - Condition exists. The maximum dosing adjustment has been reached.	Possible reduced engine performance.
4453 520669 31	Aftertreatment intermediate NH3 sensor closed loop operation - Condition exists. The maximum dosing adjustment has been reached.	None on performance.
4517 237 13	Vehicle Identification number - Out of calibration. The vehicle identification number has not been programmed into the ECM.	None on performance.

※ Some fault codes are not applied to this machine.

Fault code J1939 SPN J1939 FMI	Reason	Effect (only when fault code is active)
4518 5862 3	Aftertreatment SCR Intermediate gas temperature sensor circuit - Voltage above normal, or shorted to high source. High signal voltage detected at the aftreatment SCR intermediate temperature sensor circuit.	Possible reduced engine performance.
4519 5862 4	Aftertreatment SCR Intermediate gas temperature sensor circuit - Voltage below normal, or shorted to low source. Low signal voltage detected at the aftertreatment SCR intermediate temperature sensor circuit.	Possible reduced engine performance.
4521 5862 2	Aftertreatment SCR Intermediate gas temperature sensor - Data erratic, intermittent or incorrect. The aftertreatment SCR intermediate temperature sensor reading is irrational.	Possible reduced engine performance.
4524 5862 0	Aftertreatment SCR intermediate gas temperature - Data valid but above normal operational range - Most severe level. The aftertreatment SCR intermediate temperature sensor reading is above the engine protection limit.	Progressive power and/or speed derate increasing in severity from time of alert. If the engine protection shutdown feature is enabled, the engine will shut down 30 seconds after the red STOP lamps starts flashing.
4525 5862 16	Aftertreatment 1 SCR intermediate gas temperature - Data valid but above normal operating range - Moderately severe level. High SCR Intermediate temperature detected.	Progressive power and/or speed derate increasing in severity from time of alert. If the engine protection shutdown feature is enabled, the engine will shut down 30 seconds after the red STOP lamps starts flashing.
4526 521 2	Brake pedal position - Data erratic, intermittent or incorrect. The values of the 2 brake switch signals do not match.	None on performance.
4572 3031 9	Aftertreatment diesel exhaust fluid tank temperature - Abnormal update rate. The ECM lost communication with the aftertreatment diesel exhaust fluid tank temperature sensor.	Possible reduced engine performance.
4584 3936 14	Aftertreatment diesel particulate filter system - Special instructions. The incorrect aftertreatment diesel particulate filter system has been installed with the engine.	Engine will be shut down.
4585 4792 14	Aftertreatment 1 SCR catalyst system - Special instructions. The incorrect SCR system has been Installed.	Engine will be shut down.
4612 520701 31	Engine intake manifold pressure system monitor - Condition exists. The engine is unable to meet the air handling system commands.	Possible reduced engine performance.
4658 4331 18	Aftertreatment SCR actual dosing reagent quantity - Data valid but below normal operating range - Moderately severe level. Low aftertreatment diesel exhaust fluid flow detected.	Possible reduced engine performance.

※ Some fault codes are not applied to this machine.

Fault code J1939 SPN J1939 FMI	Reason	Effect (only when fault code is active)
4691 5585 18	Engine injector metering rail 1 cranking pressure - Data valid but below normal operating range - Moderately severe level. The fuel rail pressure during cranking is too low for the engine to start.	Engine may not start or may be difficult to start.
4713 5357 31	Engine fuel injection quantity error for multiple cylinders - Condition exists. A malfunction of all fuel injectors has been detected.	Engine may run rough, may stop running, may not start, or may be difficult to start.
4726 1239 16	Engine fuel leakage - Data valid but above normal operating range - Moderately severe level. Fuel rail pressure decay has been detected.	Engine may run rough, may stop running, may not start, or may be difficult to start.
4727 157 15	Injector metering rail 1 pressure - Data valid but above normal operating range - Least severe level. A self pumping condition has been detected in the fuel system.	Possible reduced engine performance.
4731 3031 13	Aftertreatment diesel exhaust fluid tank temperature sensor - Out of calibration. The received datalink message was not valid.	Possible reduced engine performance.
4732 1761 13	Aftertreatment diesel exhaust fluid tank level sensor - Out of calibration. The received datalink message was not valid.	None on performance.
4739 1761 11	Aftertreatment 1 diesel exhaust fluid tank level sensor - Root cause not known. An unknown error has been detected with the aftertreatment diesel exhaust fluid tank level sensor.	Possible reduced engine performance.
4769 1761 10	Aftertreatment 1 diesel exhaust fluid tank level sensor - Abnormal rate of change. A valid diesel exhaust fluid tank level reading has NOT been received.	Possible reduced engine performance.
4865 6303 3	Engine coolant level 2 sensor circuit - Voltage above normal, or shorted to high source. High signal voltage detected at the engine coolant level 2 circuit.	None on performance.
4866 6303 4	Engine coolant level 2 sensor circuit - Voltage below normal, or shorted to low source. Low signal voltage detected at the engine coolant level 2 circuit.	None on performance.
4956 520750 13	Engine variable geometry turbo (VGT) software - Out of calibration. VGT software does not match application.	Possible reduced engine performance.
4957 520750 31	Engine variable geometry turbo (VGT) software - Condition exists. The VGT actuator and ECM software is not compatible.	Possible reduced engine performance.

※ Some fault codes are not applied to this machine.

5. AAVM FAULT CODE

Fault Code	Description
A01	AAVM Communication Error -AAVM
A02	AAVM Communication Error -Front Camera
A03	AAVM Communication Error -Rear Camera
A04	AAVM Communication Error -Left Camera
A05	AAVM Communication Error -Right Camera
A06	Manual Setting Fail
A07	No MCU CID
A08	MCU CID Format Error
A09	AAVM Hardware Error -AAVM
A10	AAVM Hardware Error -Front Camera
A11	AAVM Hardware Error -Rear Camera
A12	AAVM Hardware Error -Left Camera
A13	AAVM Hardware Error -Right Camera
A14	MCU CID Model is not registered
A15	MCU CID Model can't be applied

GROUP 14 ENGINE CONTROL SYSTEM

1. MCU and Engine ECM (Electronic Control Module)

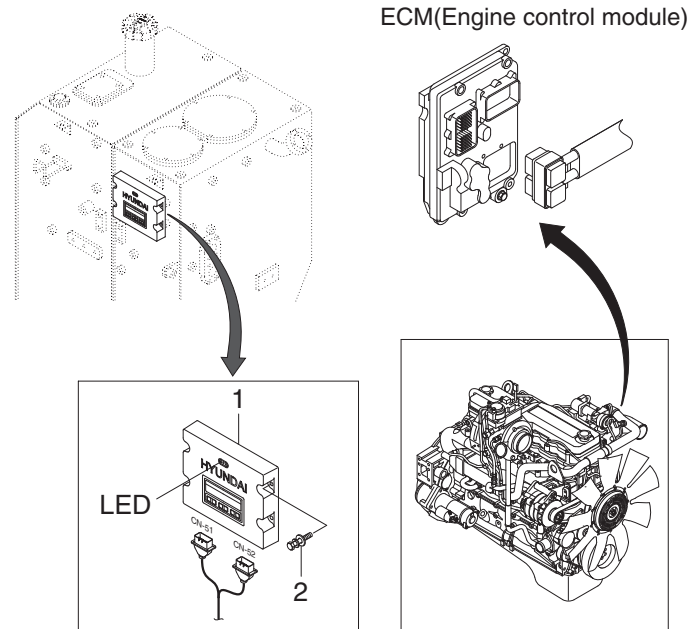

- 1 MCU
- 2 Bolt (M8)

235ZF5MS13

2. MCU ASSEMBLY

- 1) To match the pump absorption torque with the engine torque, MCU varies EPPR valve output pressure, which control pump discharge amount whenever feedbacked engine speed drops under the reference rpm of each mode set.
- 2) Three LED lamps on the MCU display as below.

LED lamp	Trouble	Service
G is turned ON	Normal	-
G and R are turned ON	Trouble on MCU	· Change the MCU
G and Y are turned ON	Trouble on serial communication line	· Check if serial communication lines between MCU and cluster are disconnected
Three LED are turned OFF	Trouble on MCU power	· Check if the input power wire (24 V, GND) of MCU is disconnected · Check the fuse

G : green, R : red, Y : yellow

GROUP 15 EPPR VALVE

1. PUMP EPPR VALVE

1) COMPOSITION

EPPR (Electro Proportional Pressure Reducing) valve consists of electro magnet and spool valve installed at main pump.

(1) Electro magnet valve

Receive electric current from MCU and move the spool proportionally according to the specific amount of electric current value.

(2) Spool valve

Is the two way direction control valve for pilot pressure to reduce main pump flow.

When the electro magnet valve is activated, pilot pressure enters into flow regulator of main pump.

(3) Pressure and electric current value for each mode

Mode		Pressure		Electric current (mA)	Engine rpm (at accel dial 10)
		kgf/cm ²	psi		
Standard	P	10	142	280 ± 30	1950 ± 50
	S	13 ± 3	189 ± 40	305 ± 30	1850 ± 50
	E	15 ± 3	218 ± 40	340 ± 30	1750 ± 50
Option	P	0	0	230 ± 30	2100 ± 50
	S	5 ± 3	73 ± 40	260 ± 30	2000 ± 50
	E	10 ± 3	142 ± 40	340 ± 30	1750 ± 50

2) HOW TO SWITCH THE POWER SHIFT (STANDARD ↔ OPTION) ON THE CLUSTER

You can switch the EPPR valve pressure set by selecting the power shift (standard ↔ option).

- Management
- Service menu

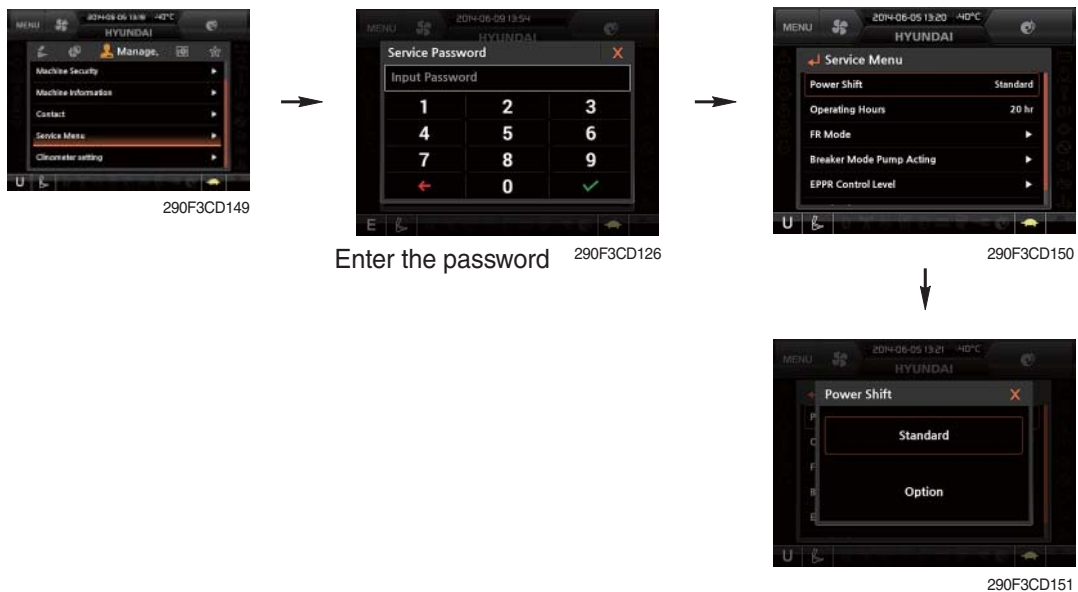

- Power shift (standard/option) : Power shift pressure can be set by option menu.

3) OPERATING PRINCIPLE

(1) Structure

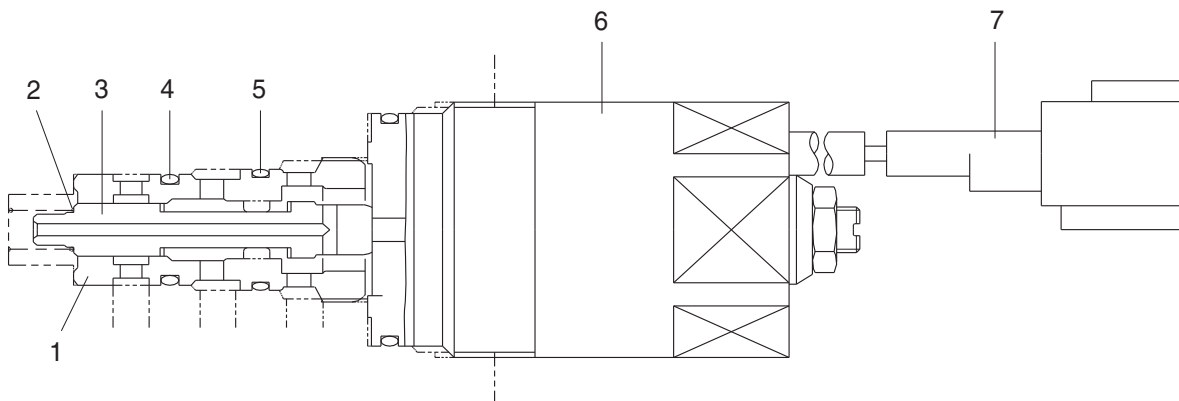

5-22(1)

- 1 Sleeve
- 2 Spring
- 3 Spool

- 4 O-ring
- 5 O-ring

- 6 Solenoid valve
- 7 Connector

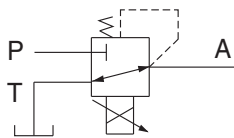

P Pilot oil supply line (pilot pressure)

T Return to tank

A Secondary pressure to flow regulator at main pump

(2) Neutral

Pressure line is blocked and A oil returns to tank.

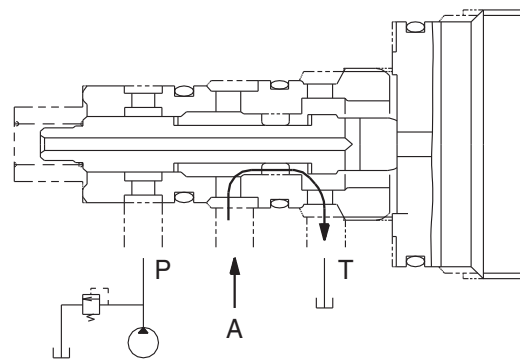
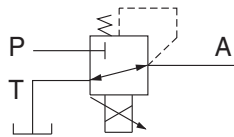

(3) Operating

Secondary pressure enters into A.

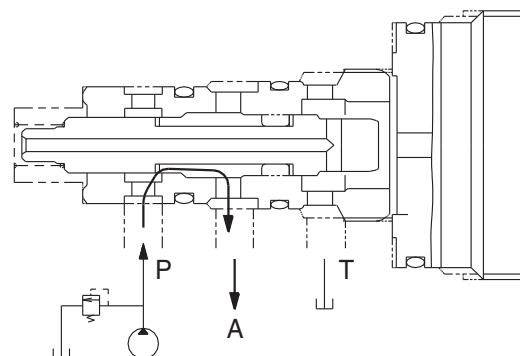
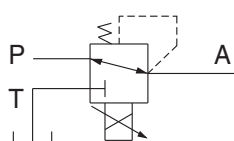

5-22(2)

4) EPPR VALVE CHECK PROCEDURE

(1) Check electric current value at EPPR valve

- ① Disconnect connector CN-75 from EPPR valve.
- ② Insert the adapter to CN-75 and install multimeter as figure.
- ③ Start engine.
- ④ Set S-mode and cancel auto decel mode.
- ⑤ Position the accel dial at 10.
- ⑥ If rpm display show approx 1850 ± 50 rpm check electric current at bucket circuit relief position.
- ⑦ Check electric current at bucket circuit relief position.

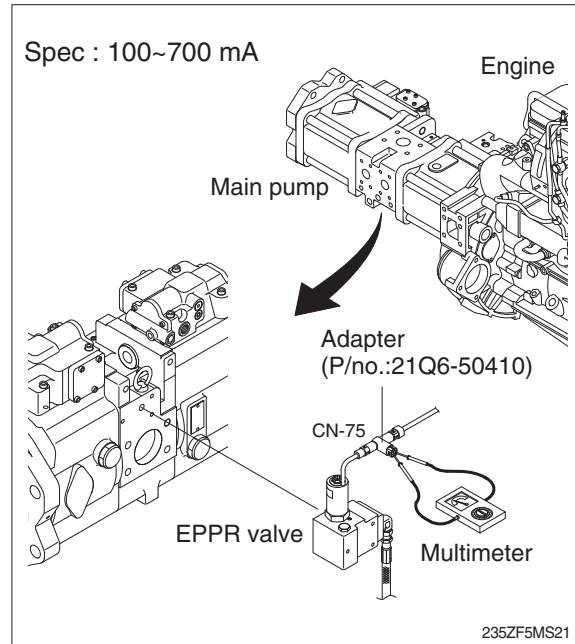

(2) Check pressure at EPPR valve

- ① Remove plug and connect pressure gauge as figure.
 - Gauge capacity : 0 to 50 kgf/cm²
(0 to 725 psi)
- ② Start engine.
- ③ Set S-mode and cancel auto decel mode.
- ④ Position the accel dial at 10.
- ⑤ If tachometer show approx 1850 ± 50 rpm check pressure at relief position of bucket circuit by operating bucket control lever.
- ⑥ If pressure is not correct, adjust it.
- ⑦ After adjust, test the machine.

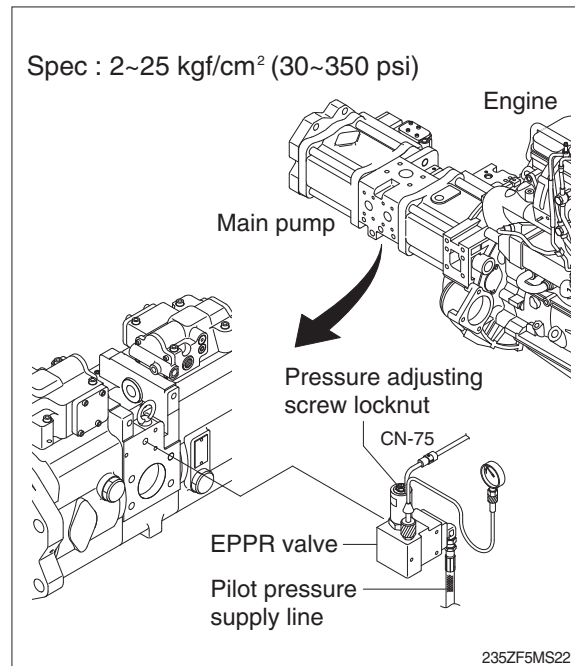

2. BOOM PRIORITY EPPR VALVE

1) COMPOSITION

The boom priority EPPR valve is built in a manifold and mainly consisting of valve body and coil. This EPPR valve installed under the solenoid valve.

2) CONTROL

The boom priority EPPR valve has to be controlled by a specific electronic amplifier card, which is supplying the coil with a current 580 mA at 30Ω and 24 V.

3) OPERATING PRINCIPLE

(1) Structure

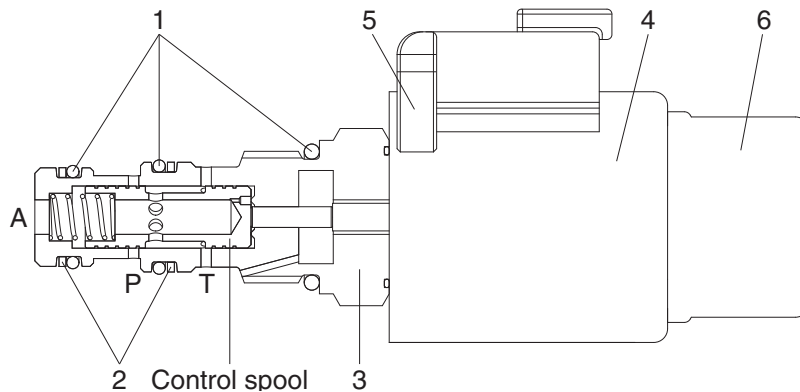

21095MS14

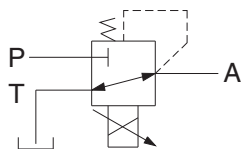

P : Pilot supply line
T : Return to tank
A : Secondary pressure to flow MCV

- | | | | | | |
|---|--------------|---|------------|---|-----------|
| 1 | O-ring | 3 | Valve body | 5 | Connector |
| 2 | Support ring | 4 | Coil | 6 | Cover cap |

(2) Operation

In de-energized mode the inlet port (P) is closed and the outlet port (A) is connected to tank port (T).

In energized mode the solenoid armature presses onto the control spool with a force corresponding to the amount of current. This will set a reduced pressure at port A. The setting is proportional to the amount of current applied.

(3) Maximum pressure relief

If a pressure from outside is applied on port A the valve may directly switch to tank port (T) and protect the system before overload.

2) EPPR VALVE CHECK PROCEDURE

(1) Check electric current value at EPPR valve

- ① Disconnect connector CN-133 from EPPR valve.
- ② Insert the adapter to CN-133 and install multimeter as figure.
- ③ Start engine.
- ④ Set S-mode and cancel auto decel mode.
- ⑤ If rpm display approx 1850 ± 50 rpm disconnect one wire harness from EPPR valve.
- ⑥ Check electric current in case of combined boom up and swing operation.

Spec : 400~600 mA
(combined boom up and swing operation)

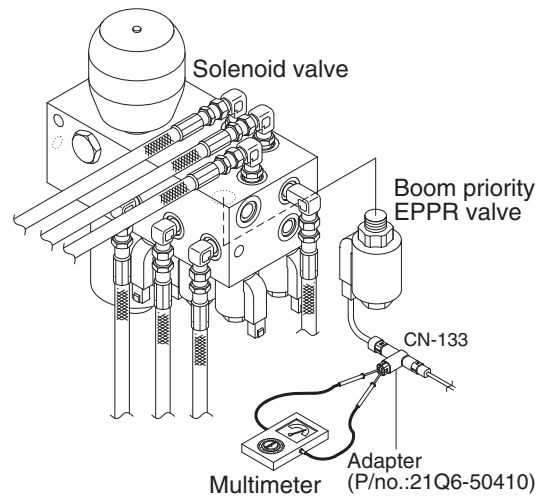

21095MS15

(2) Check pressure at EPPR valve

- ① Remove hose from A5 port and connect pressure gauge as figure.
 - Gauge capacity : 0 to 50 kgf/cm²
(0 to 725 psi)
- ② Start engine.
- ③ Set S-mode and cancel auto decel mode.
- ④ If rpm display approx 1850 ± 50 rpm check pressure (In case of combined boom up and swing operation).
- ⑤ If pressure is not correct, adjust it.
- ⑥ After adjust, test the machine.

Spec : 12~37 kgf/cm² (170~530 psi)
(combined boom up and swing operation)

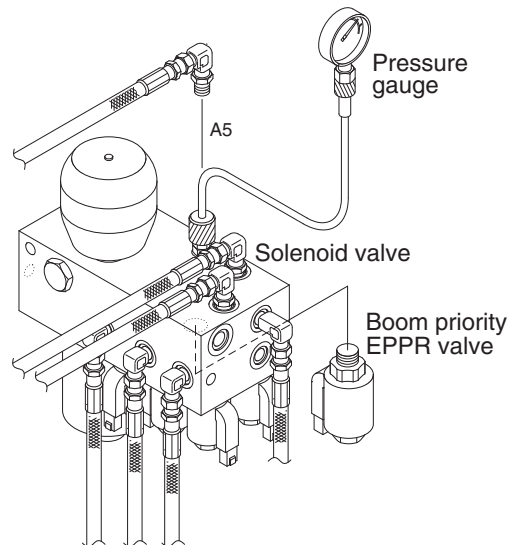

21095MS16

GROUP 16 MONITORING SYSTEM

1. OUTLINE

Monitoring system consists of the monitor part and switch part.

The monitor part gives warnings when any abnormality occurs in the machine and informs the condition of the machine. Also, monitor part is to set and display for modes, monitoring and utilities with the switches.

Various select switches are built into the monitor panel, which act as the control portion of the machine control system.

2. CLUSTER

1) MONITOR PANEL



235ZF3CD05

※ The warning lamp pops up and/or blinks and the buzzer sounds when the machine has a problem.

The warning lamp lights up or blinks until the problem is cleared. Refer to page 5-65 for details.

※ This cluster is adjustable.

- Vertical (forward/backward) : each 15°
- Horizontal (left only) : 8°

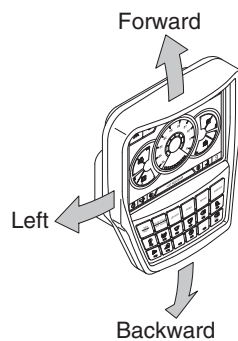

290F3CD47

2) CLUSTER CHECK PROCEDURE

(1) Start key : ON

① Check monitor

- a. Buzzer sounding for 4 seconds with HYUNDAI logo on cluster.
- ※ If the ESL mode is set to the enable, enter the password to start engine.

② After initialization of cluster, the operating screen is displayed on the LCD.

Also, self diagnostic function is carried out.

- a. Engine rpm display : 0 rpm
- b. Engine coolant temperature gauge : White range
- c. Hydraulic oil temperature gauge : White range
- d. Fuel level gauge : White range
- e. DEF/AdBlue® Level gauge : White range

③ Indicating lamp state

- a. Power mode pilot lamp : E mode or U mode
- b. Work mode pilot lamp : General operation mode (bucket)
- c. Travel speed pilot lamp : Low (turtle)

(2) Start of engine

① Check machine condition

- a. RPM display indicates at present rpm
- b. Gauge and warning lamp : Indicate at present condition.
- ※ When normal condition : All warning lamp OFF
- c. Work mode selection : General work
- d. Power mode selection : E mode or U mode
- e. Travel speed pilot lamp : Low (turtle)

② When warming up operation

- a. Warming up pilot lamp : ON
- b. After engine started, engine speed increases to 1200 rpm.
- ※ Others same as above.

③ When abnormal condition

- a. The warning lamp pops up and the buzzer sounds.
- b. If BUZZER STOP switch is pressed, buzzer sound is canceled but the warning lamp lights up or blinks until normal condition.
- ※ The pop-up warning lamp moves to the original position and warning lamp lights up or blinks when the buzzer stop switch is pushed. Also the buzzer stops.
- ※ Refer to page 5-65 for details.

1) CLUSTER CONNECTOR

(1) CN-56A

No.	Name	Signal
1	Battery 24V	20~32V
2	Power IG (24V)	20~32V
3	GND	-
4	CAN 1 (H)	0~5V
5	CAN 1 (L)	0~5V
6	CAN 2 (H)	0~5V
7	CAN 2 (L)	20~32V
8	N.C.	-
9	N.C.	-
10	Aux left	0~5V
11	Aux right	0~5V
12	Aux GND	-

(2) CN-56B

No.	Name	Signal
1	CAM 6.5V	6.3~6.7V
2	CAM GND	-
3	CAM DIFF (H)	0~5V
4	CAM DIFF (L)	0~5V
5	CAM 1	NTSC signal
6	CAM 2	NTSC signal
7	CAM 3	NTSC signal
8	CAM shield	0~5V

NTSC : National Television System Committee

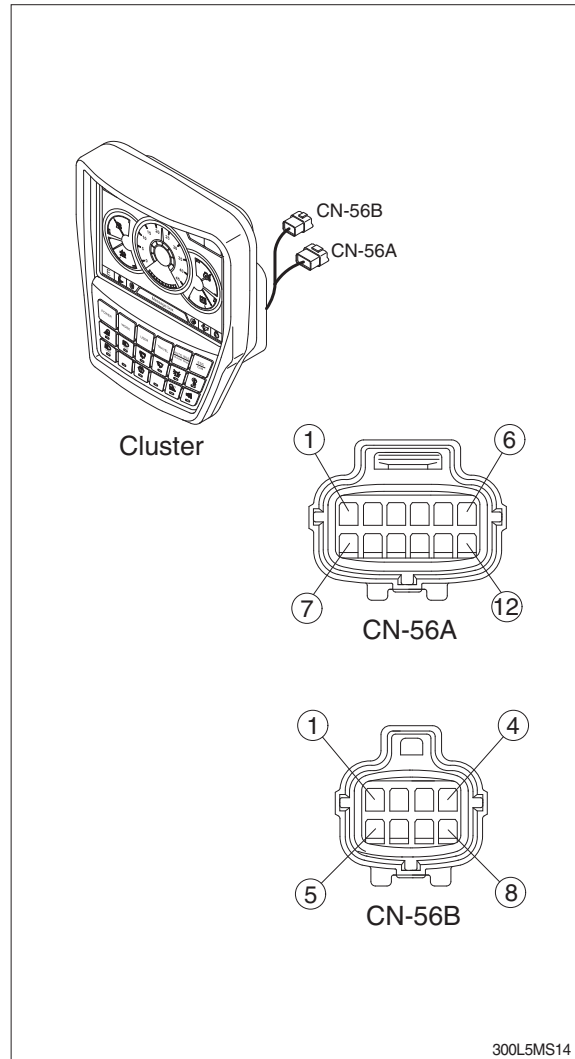

300L5MS14

4) GAUGE

(1) Operation screen

When you first turn starting switch ON, the operation screen will appear.



235F3CD07

- | | |
|------------------------------------|---------------------------|
| 1 RPM / Speed gauge | 5 DEF/AdBlue® level gauge |
| 2 Engine coolant temperature gauge | 6 Tripmeter display |
| 3 Hydraulic oil temperature gauge | 7 Eco gauge |
| 4 Fuel level gauge | 8 Accel dial gauge |

※ Operation screen type can be set by the screen type menu of the display.
Refer to page 5-86 for details.

(2) RPM / Speed gauge



290F3CD49

① This display the engine speed.

(3) Engine coolant temperature gauge



290F3CD53

① This gauge indicates the temperature of coolant.

- White range : 40-107°C (104-225°F)
- Red range : Above 107°C (225°F)



② If the indicator is in the red range or  lamp pops up and the buzzer sounds turn OFF the engine and check the engine cooling system.

※ If the gauge indicates the red range or  lamp blinks in red even though the machine is on the normal condition, check the electric device as that can be caused by the poor connection of electricity or sensor.

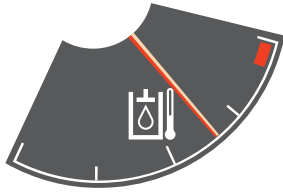
(4) Hydraulic oil temperature gauge





290F3CD54

- ① This gauge indicates the temperature of hydraulic oil.
 - White range : 40-105°C(104-221°F)
 - Red range : Above 105°C(221°F)
 - ② If the indicator is in the red range or  lamp pops up and the buzzer sounds reduce the load on the system. If the gauge stays in the red range, stop the machine and check the cause of the problem.
- ※ If the gauge indicates the red range or  lamp blinks in red even though the machine is on the normal condition, check the electric device as that can be caused by the poor connection of electricity or sensor.

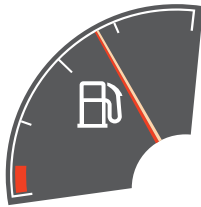
(5) Fuel level gauge





290F3CD55

- ① This gauge indicates the amount of fuel in the fuel tank.
 - ② Fill the fuel when the red range, or  lamp pops up and the buzzer sounds.
- ※ If the gauge indicates the red range or  lamp blinks in red even though the machine is on the normal condition, check the electric device as that can be caused by the poor connection of electricity or sensor.

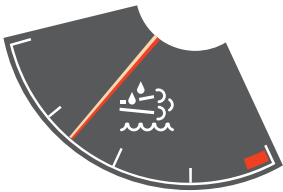
(6) DEF/AdBlue® Level gauge



290F3CD57

- ① This gauge indicates the amount of liquid in the DEF/AdBlue® tank.
 - ② Fill the DEF/AdBlue® when the red range, or  lamp pops up and the buzzer sounds.
 - ③ Do not pour DEF/AdBlue® any more when the DEF/AdBlue® fill up warning lamp lights ON.
- ※ Refer to page 5-70.
- ※ If the gauge indicates the red range or  lamp blinks in red even though the machine is on the normal condition, check the electric device as that can be caused by the poor connection of electricity or sensor.

(7) Tripmeter display

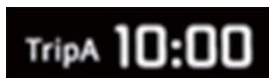

290F3CD56

- ① This displays the engine the tripmeter.
- ※ Refer to page 5-91 for details.

(8) Eco gauge



290F3CD58

- ① This gauge indicates the fuel consumption rate and machine load status. So that operators can be careful with fuel economy.
- ② The fuel consumption rate or machine load is higher, the number of segment is increased.
- ③ The color of Eco gauge indicates operation status.
 - White : Idle operation
 - Green : Economy operation
 - Yellow : Non-economy operation at a medium level.
 - Red : Non-economy operation at a high level.

(9) Accel dial gauge



290F3CD59

- ① This gauge indicates the level of accel dial.

5) WARNING LAMPS

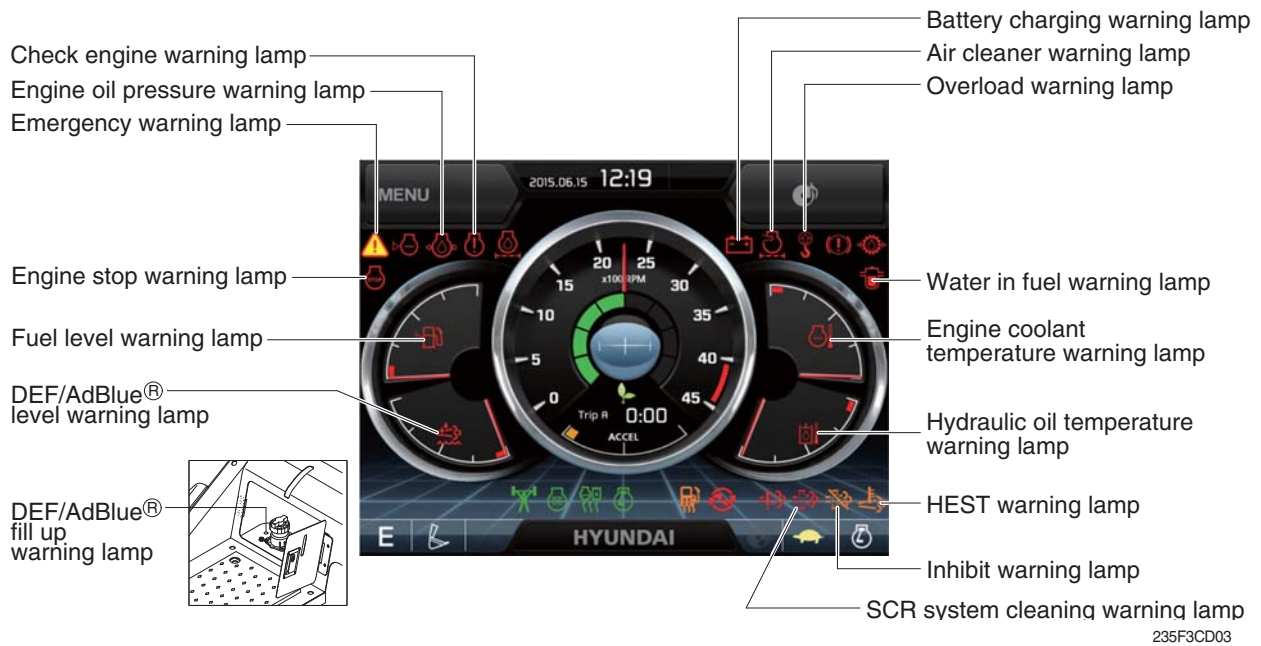

※ Warning lamps and buzzer





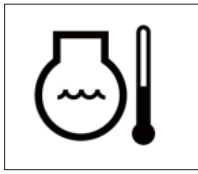

Warnings	When error happened	Lamps and buzzer
All warning lamps except below	Warning lamp pops up on the center of the LCD and the buzzer sounds	<ul style="list-style-type: none"> The pop-up warning lamp moves to the original position and blinks, and the buzzer stops when ; - the buzzer stop switch is pushed - the knob of the haptic controller is pushed - the lamp of the LCD is touched
	Warning lamp pops up on the center of the LCD and the buzzer sounds	<ul style="list-style-type: none"> The pop-up warning lamp moves to the original position and light ON or blinks, and the buzzer stops when ; - the buzzer stop switch is pushed - the knob of the haptic controller is pushed - the lamp of the LCD is touched <p>※ Refer to page 5-70 for details.</p>
	Warning lamp pops up on the center of the LCD and the buzzer sounds	<ul style="list-style-type: none"> The pop-up warning lamp moves to the original position and lights ON, and the buzzer stops when 2 seconds elapsed.
	Warning lamp pops up on the center of the LCD and the buzzer sounds	<ul style="list-style-type: none"> The pop-up warning lamp moves to the original position and blinks, and the buzzer stops when 2 seconds elapsed.
	Warning lamp pops up on the center of the LCD and the buzzer sounds	<p>※ Refer to page 5-66 for details.</p>

※ Refer to page 5-75 for the buzzer stop switch .

(1) Engine coolant temperature warning lamp







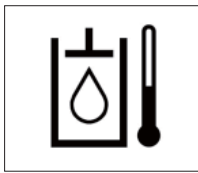

290F3CD61

- ① Engine coolant temperature warning is indicated two steps.
 - 103°C over : The  lamp pops up and the buzzer sounds.
 - 107°C over : The  lamp pops up and the buzzer sounds.
- ② The pop-up ,  lamps move to the original position and blinks when the buzzer stop switch  is pushed. And the buzzer stops and ,  lamps keep blink.
- ③ Check the cooling system when the lamps keep blink.

(2) Hydraulic oil temperature warning lamp



290F3CD62

- ① Hydraulic oil temperature warning is indicated two steps.
 - 100°C over : The  lamp pops up and the buzzer sounds.
 - 105°C over : The  lamp pops up and the buzzer sounds.
- ② The pop-up ,  lamps move to the original position and blinks when the buzzer stop switch  is pushed. And the buzzer stops and ,  lamps keep blink.
- ③ Check the hydraulic oil level and hydraulic oil cooling system.

(3) Fuel level warning lamp

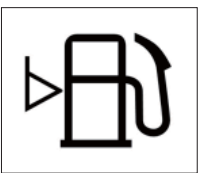

290F3CD63

- ① This warning lamp pops up and the buzzer sounds when the level of fuel is below 54 ℓ (14.3 U.S. gal).
- ② Fill the fuel immediately when the lamp blinks.

(4) Emergency warning lamp



290F3CD64

- ① This warning lamp pops up and the buzzer sounds when each of the below warnings is happened.
 - Engine coolant overheating (over 107°C)
 - Hydraulic oil overheating (over 105°C)
 - MCU input voltage abnormal
 - Cluster communication data error
 - Engine ECM communication data error
- ※ The pop-up warning lamp moves to the original position and blinks when the buzzer stop switch  is pushed. And the buzzer stops.
- ② When this warning lamp blinks, machine must be checked and serviced immediately.

(5) Engine oil pressure warning lamp

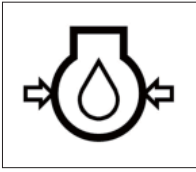

290F3CD65

- ① This warning lamp pops up and the buzzer sounds when the engine oil pressure is low.
- ② If the lamp blinks, shut OFF the engine immediately. Check oil level.

(6) Check engine warning lamp



290F3CD66

- ① This warning lamp pops up and the buzzer sounds when the communication between MCU and engine ECM on the engine is abnormal, or if the cluster received specific fault code from engine ECM.
- ② Check the communication line between them.
If the communication line is OK, then check the fault codes on the cluster.

(7) Battery charging warning lamp

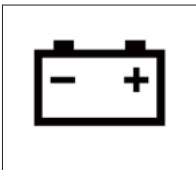

290F3CD67

- ① This warning lamp pops up and the buzzer sounds when the battery charging voltage is low.
- ② Check the battery charging circuit when this lamp blinks.

(8) Air cleaner warning lamp

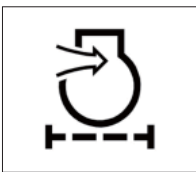

290F3CD68

- ① This warning lamp pops up and the buzzer sounds when the filter of air cleaner is clogged.
- ② Check the filter and clean or replace it.

(9) Overload warning lamp (opt)



290F3CD69

- ① When the machine is overload, the overload warning lamp pops up and the buzzer sounds during the overload switch is ON. (if equipped)
- ② Reduce the machine load.

(10) Engine stop warning lamp



290F3CD252

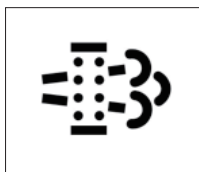

- ① This warning lamp pops up and the buzzer sounds when 30 minutes elapsed with empty condition of the DEF/AdBlue® tank, stop the engine immediately and check the DEF/AdBlue® tank.
- ② Fill the DEF/AdBlue® immediately in the DEF/AdBlue® tank.
* **Refer to page 5-70.**
- ③ This lamp pops up and the buzzer sounds when the stationary SCR system cleaning is not performed.
* **Refer to page 5-68.**
* **Please contact your Hyundai service center or local dealer.**

(11) SCR (selective catalytic reduction) system cleaning warning lamp



290F3CD70

- ① This warning lamp lights ON or blinks when the SCR system cleaning is needed as table below.

Warning lamp			Description
SCR	Check engine	Stop engine	
			
Off	Off	Off	· Automatic SCR system cleaning
Blink	Off	Off	· The status of a manual (stationary) SCR system cleaning when the SCR system cleaning switch has been activated. * Refer to page 5-69.
On	On	Off	· The aftertreatment SCR system needs to be cleaned immediately. · Engine power will be reduced automatically if action is not taken. * The SCR system cleaning can be accomplished by : - Changing to more challenging duty cycle. - Performing a manual SCR system cleaning.
On	On	On	· These lamps will be ON when a stationary (manual) SCR system cleaning is not performed. · Stop the engine immediately. · Please contact your Hyundai service center or local dealer.

(12) SCR system cleaning inhibit warning lamp

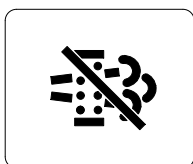

2609A3CD20

- ① This warning lamp indicates, when illuminated, the SCR system cleaning switch is pushed inhibit position, therefore automatic and manual SCR system cleaning can not occur.
* **Refer to the operator's manual page 3-32 for the SCR system cleaning switch.**

※ Manual SCR system cleaning

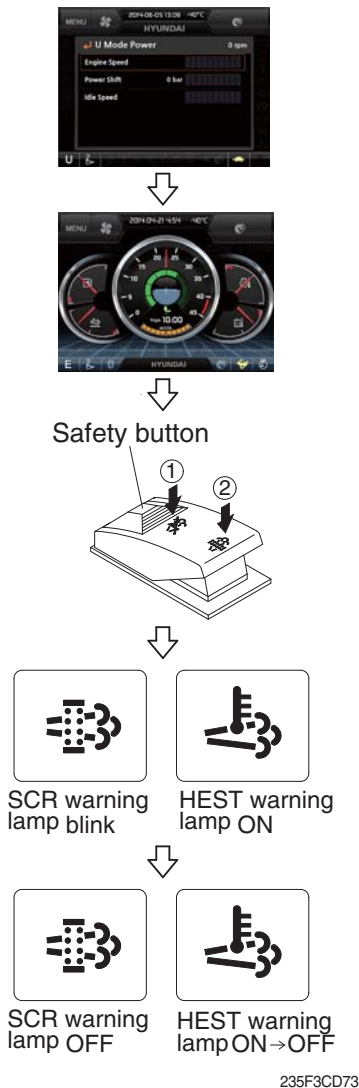

※ Manual SCR system cleaning applies if the machine is in a fireproof area.

※ To stop a manual SCR system cleaning before it has completed, set to the SCR system cleaning switch to the inhibit position or turn OFF the engine.

① Stop and park the machine.

② Pull the safety button and push the switch to position ② to initiate the manual SCR system cleaning.

※ Refer to the operator's manual page 3-32 for the SCR system cleaning switch operation.

※ The engine speed may increase to 950~1050 rpm and SCR system cleaning begins and it will take approximately 20~60 minutes.

③ The SCR system cleaning warning lamp will blink and HEST warning lamp will light ON during the SCR system cleaning is operating.

④ The SCR system cleaning and/or HEST warning lamp will light OFF when the SCR system cleaning is completed.

(13) HEST (High exhaust system temperature) warning lamp



2609A3CD21

① This warning lamp indicates, when illuminated, that exhaust temperatures are high due to SCR system cleaning.

② The lamp will also illuminate during a manual SCR system cleaning.

③ When this lamp is illuminated, be sure the exhaust pipe outlet is not directed at any surface or material that can melt, burn, or explode.

⚠ When this lamp is illuminated, the exhaust gas temperature could reach 800°C [1500°F], which is hot enough to ignite or melt common materials, and to burn people.

※ The lamp does not signify the need for any kind of equipment or engine service; It merely alerts the equipment operator to high exhaust temperatures. It will be common for the lamp to illuminate on and off during normal equipment operation as the engine completes SCR system cleaning.

(14) DEF/AdBlue® level warning lamp



290F3CD257

① This warning lamp indicates when ON or blinking, that the DEF/AdBlue® level is low as table below.

※ **It is recommended that the DEF/AdBlue® tank be filled completely full of the DEF/AdBlue® in order to correct any fault conditions.**

Warning lamp			Description
DEF/AdBlue® level	Check engine	Stop engine	
On	Off	Off	· The DEF/AdBlue® level has fallen below the initial warning level (10%).
Blink	Off	Off	· The DEF/AdBlue® level has fallen below the critical warning level (5%).
Blink	On	Off	· The DEF/AdBlue® level has fallen below the initial derate level (2.5%). · The engine power will be limited automatically.
Blink	On	On	· This is happened when 30 minutes elapsed with empty conditions (0%) of the DEF/AdBlue® tank. · The engine will enter the final derate level which may include low idle lock or engine shutdown with restart limitations. · In order to remove the final derate, the DEF/AdBlue® tank must be filled to above 10 percent gauge reading.

(15) DEF/AdBlue® fill up warning lamp

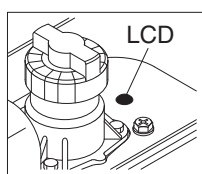

290F3CD272

① This lamp lights ON when the DEF/AdBlue® tank is completely filled with DEF/AdBlue®.

※ **Fill the tank with the DEF/AdBlue® after start switch ON and then turn OFF the start switch.**

※ **Do not pour DEF/AdBlue® any more when this lamp lights ON. Otherwise DEF/AdBlue® tank may freeze and burst in winter season.**

(16) Water in fuel warning lamp



210WF3CD02

① This warning lamp pops up and the buzzer sounds when the water separator is full of water or malfunctioning.













※ **When this lamp blinks, stop the machine and spill water out of the separator.**

4) PILOT LAMPS



290F3CD74

(1) Mode pilot lamps

No	Mode	Pilot lamp	Selected mode
1	Power mode		Heavy duty power work mode
			Standard power mode
			Economy power mode
2	User mode		User preferable power mode
3	Work tool mode		General operation - IPC speed mode
			General operation - IPC balance mode
			General operation - IPC efficiency mode
			Breaker operation mode
			Crusher operation mode
4	Travel mode		Low speed traveling
			High speed traveling
5	Auto idle mode		Auto idle

(2) Power max pilot lamp



290F3CD78

- ① The lamp will be ON when pushing power max switch on the LH RCV lever.
 - ② The power max function is operated maximum 8 seconds.
- ※ Refer to the operator's manual page 3-34 for power max function.

(3) Preheat pilot lamp

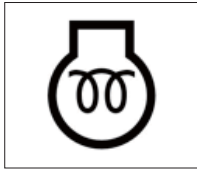

290F3CD79

- ① Turning the start key switch ON position starts preheating in cold weather.
- ② Start the engine after this lamp is OFF.

(4) Warming up pilot lamp

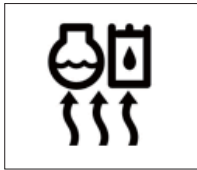

290F3CD80

- ① This lamp is turned ON when the coolant temperature is below 30°C (86°F).
- ② The automatic warming up is cancelled when the engine coolant temperature is above 30°C, or when 10 minutes have passed since starting the engine.

(5) Decel pilot lamp



290F3CD81

- ① Operating one touch decel switch on the RCV lever makes the lamp ON.
 - ② Also, the lamp will be ON and engine speed will be lowered automatically to save fuel consumption when all levers and pedals are at neutral position, and the auto idle function is selected.
- ※ **One touch decel is not available when the auto idle pilot lamp is turned ON.**
- ※ **Refer to the operator's manual page 3-33.**

(6) Fuel warmer pilot lamp

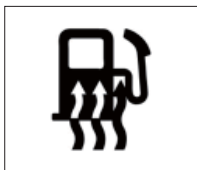

290F3CD82

- ① This lamp is turned ON when the coolant temperature is below 10°C (50°F) or the hydraulic oil temperature 20°C (68°F).
- ② The automatic fuel warming is cancelled when the engine coolant temperature is above 60°C, and the hydraulic oil temperature is above 45°C since the start switch was ON position.

(7) Maintenance pilot lamp



290F3CD83

- ① This lamp will be ON when the consuming parts are needed to change or replace. It means that the change or replacement interval of the consuming parts remains below 30 hours.
 - ② Check the message in maintenance information of main menu. Also, this lamp lights ON for 3 minutes when the start switch is ON position.
- ※ **Refer to the page 5-84.**

(8) Entertainment pilot lamp



290F3CD84

① This lamp is on when audio or video files are playing.

※ **Refer to the page 5-90.**

(9) Smart key pilot lamp (opt)

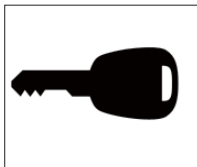

290F3CD214

① This lamp is ON when the engine is started by the start button.

② This lamp is red when the authentication fails, green when succeeds.

※ **Refer to the page 5-85.**

7) SWITCHES



235F3CD86

※ When some of the switches are selected, the pilot lamps are displayed on the LCD. Refer to the page 5-71 for details.

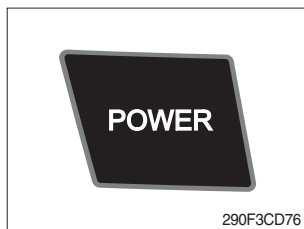

(1) Power mode switch

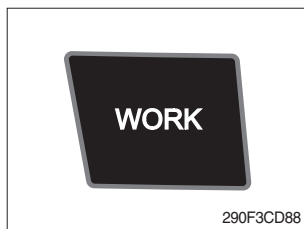

- ① This switch is to select the machine power mode and selected power mode pilot lamp is displayed on the pilot lamp position.
 - P : Heavy duty power work.
 - S : Standard power work.
 - E : Economy power work.
- ② The pilot lamp changes E → S → P → E in order.

(2) Work mode switch



- ① This switch is to select the machine work mode, which shifts from general operation mode to optional attachment operation mode.
 -  : General operation mode
 -  : Breaker operation mode (if equipped)
 -  : Crusher operation mode (if equipped)
 - Not installed : Breaker or crusher is not installed.

※ Refer to the operator's manual page 4-7 for details.

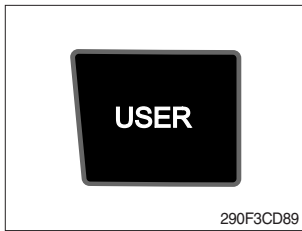

(3) User mode switch



- ① This switch is used to memorize the current machine operating status in the MCU and activate the memorized user mode.
 - Memory : Automatically saved after key OFF.
 - Action : Push this switch.
 - Cancel : Push this switch once more.
- ② Refer to the page 5-79 for another set of user mode.

(4) Travel speed switch



- ① This switch is used to select the travel speed alternatively.
 -  : Low speed
 -  : High speed
- ※ Do not change the setting of the travel speed switch. Machine stability may be adversely affected.
- ▲ Personal injury can result from sudden changes in machine stability.

(5) Auto idle/ buzzer stop switch

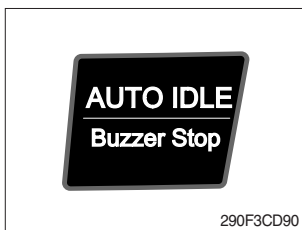

- ① This switch is used to activate or cancel the auto idle function.
 - Pilot lamp ON : Auto idle function is activated.
 - Pilot lamp OFF : Auto idle function is cancelled.
- ② The buzzer sounds when the machine has a problem. In this case, push this switch and buzzer stops, but the warning lamp blinks until the problem is cleared.

(6) Escape/Camera switch

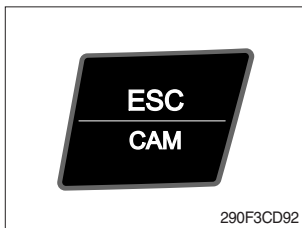

- ① This switch is used to return to the previous menu or parent menu.
- ② In the operation screen, pushing this switch will display the view of the camera on the machine (if equipped). Please refer to page 5-91 for the camera.
- ③ If the camera is not installed, this switch is used only ESC function.

(7) Work light switch



- ① This switch is used to operate the work light.
- ② The pilot lamp is turned ON when operating the switch.

(8) Head light switch



- ① This switch is used to operate the head light.
- ② The pilot lamp is turned ON when operating the switch.

(9) Intermittent wiper switch



- ① This switch is used to wipe operates intermittently.
- ② The pilot lamp is turned ON when operating the switch.

(10) Wiper switch



- ① This switch is used to operate the window wiper.
- ② Note that the wiper will self-park when switched off.
- ③ The pilot lamp is turned ON when operating the switch.
- ※ **If the wiper does not operate with the switch in ON position, turn the switch OFF immediately. Check the cause. If the switch remains ON, motor failure can result.**

(11) Washer switch

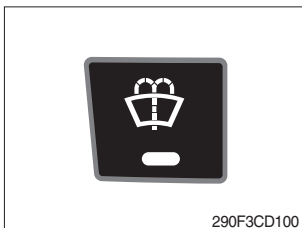

- ① The washer liquid is sprayed and the wiper is operated only while pressing this switch.
- ② The pilot lamp is turned ON when operating the switch.

(12) Cab light switch



- ① This switch turns ON the cab light on the cab.
- ② The pilot lamp is turned ON when operating the switch.

(13) Beacon switch

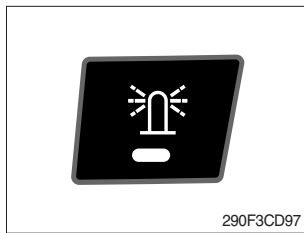

- ① This switch turns ON the rotary light on the cab.
- ② The pilot lamp is turned ON when operating the switch.

(14) Overload switch

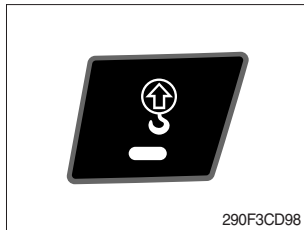

- ① When this switch turned ON, buzzer makes sound and overload warning lamp comes ON in case that the machine is overload.
 - ② When it turned OFF, buzzer stops and warning lamp goes out.
- ▲ Overloading the machine could impact the machines stability which could result in tipover hazard. A tipover hazard could result in serious injury or death. Always activate the overload warning device before you handle or lift objects.**

(15) Travel alarm switch

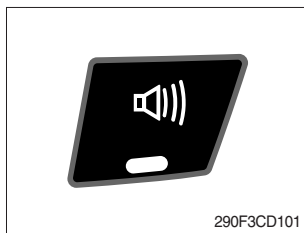

- ① This switch is to activate travel alarm function surrounding when the machine travels.
 - ON : The travel alarm function is activated.
 - OFF : The travel alarm function is not activated.

(16) Main menu quick touch switch



- ① This switch is to activate the main menu in the cluster.
 - ※ Refer to the page 5-78.

(17) Entertainment quick touch switch



- ① This switch is to activate the entertainment control menu in the cluster.
 - ※ Refer to the page 5-90.

8) MAIN MENU

※ You can select or set the menu by the haptic controller or touch screen.



On the operation screen, tap MENU to access the main menu screen.

On the sub menu screen, you can tap the menu bar to access functions or applications.

· Operation screen



(1) Structure

No	Main menu	Sub menu	Description
1	 Mode 290F3CD103	Work tool U mode power Boom/Arm speed Auto power boost IPC mode Auto engine shutdown (option) Initial mode Emergency mode	Breaker, Crusher, Not installed User mode only Boom speed, Arm speed Enable, Disable Speed mode, Balance mode, Efficiency mode One time, Always, Disable Key on initial mode, Accel initial mode / step Switch function
2	 Monitoring 290F3CD104	Active fault Logged fault Delete logged fault Monitoring	MCU, Engine ECM MCU, Engine ECM All logged fault delete, Initialization canceled Machine information, Switch status, Output status,
3	 Management 290F3CD105	Fuel rate information Maintenance information Machine security Machine information Contact Service menu Clinometer Update	General record, Hourly, Daily, Mode record Replacement, Change interval oils and filters ESL mode setting, Password change Model, MCU, Monitor, Haptic / switch controller, RMCU, Relay drive unit, FATC, AAVM (opt) A/S phone number, A/S phone number change Power shift, Operating hour, Breaker mode pump acting, EPPR current level, Overload pressure Clinometer setting Cluster, ETC device
4	 Display 290F3CD106	Display item Clock Brightness Unit setup Language selection Screen type	Engine speed, Tripmeter A, Tripmeter B, Tripmeter C Clock Manual, Auto Temperature, Pressure, Flow, Distance, Date format Korean, English, Chinese, ETC A type, B type
5	 Utilities 290F3CD107	Entertainment Tripmeter Camera	Play Video, Audio, Smart terminal. 3 kinds (A, B, C) Number of active, Display order, AAVM (opt)

(2) Mode setup

① Work tool

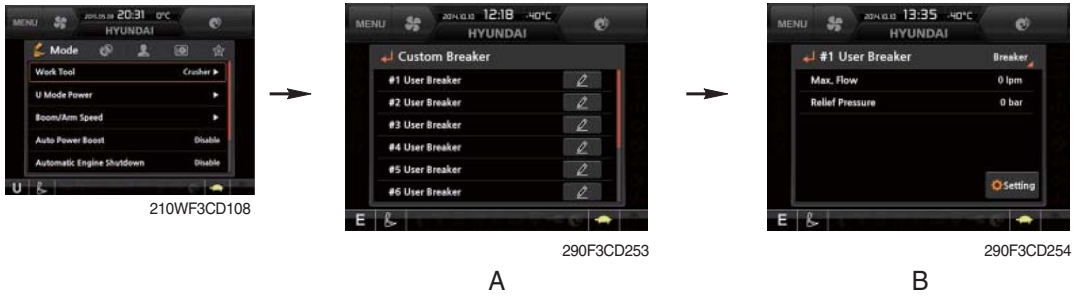

- Select on installed optional attachment
 - A : It can set the user's attachment.
It is available in setting #1~#10.
 - B : Max flow - Set the maximum flow for the attachment.
Relief pressure - Set the relief pressure.

② U mode power



Step (■)	Engine speed (rpm)	Idle speed (rpm)	Power shift (bar)
1	1300	750	0
2	1400	800	3
3	1500	850	6
4	1600	900	9
5	1700	950	12
6	1800	1000 (auto decel)	16
7	1850	1050	20
8	1900	1100	26
9	1950	1150	32
10	2000	1200	38

- Engine high idle rpm, auto idle rpm and pump torque (power shift) can be modulated and memorized separately in U-mode.
- U-mode can be activated by user mode switch.

※ One touch decel & low idle : 1000 rpm

③ Boom/Arm speed



- **Boom speed**
 - Boom priority function can be activated or cancelled
Enable - Boom up speed is automatically adjusted as working conditions by the MCU.
Disable - Normal operation
- **Arm speed**
 - Arm regeneration function can be activated or cancelled.
Enable - Arm in speed is up.
Disable - Normal operation.

④ Auto power boost

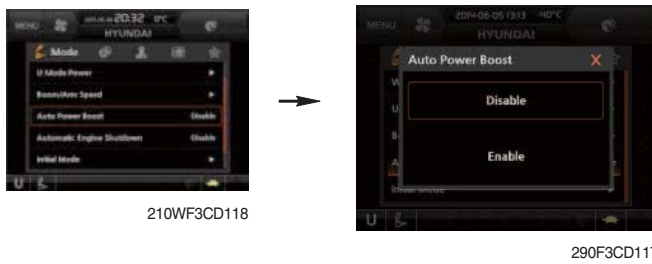

- The power boost function can be activated or cancelled.
 - Enable - The digging power is automatically increased as working conditions by the MCU. It is operated max 8 seconds.
 - Disable - Not operated.

⑤ IPC mode

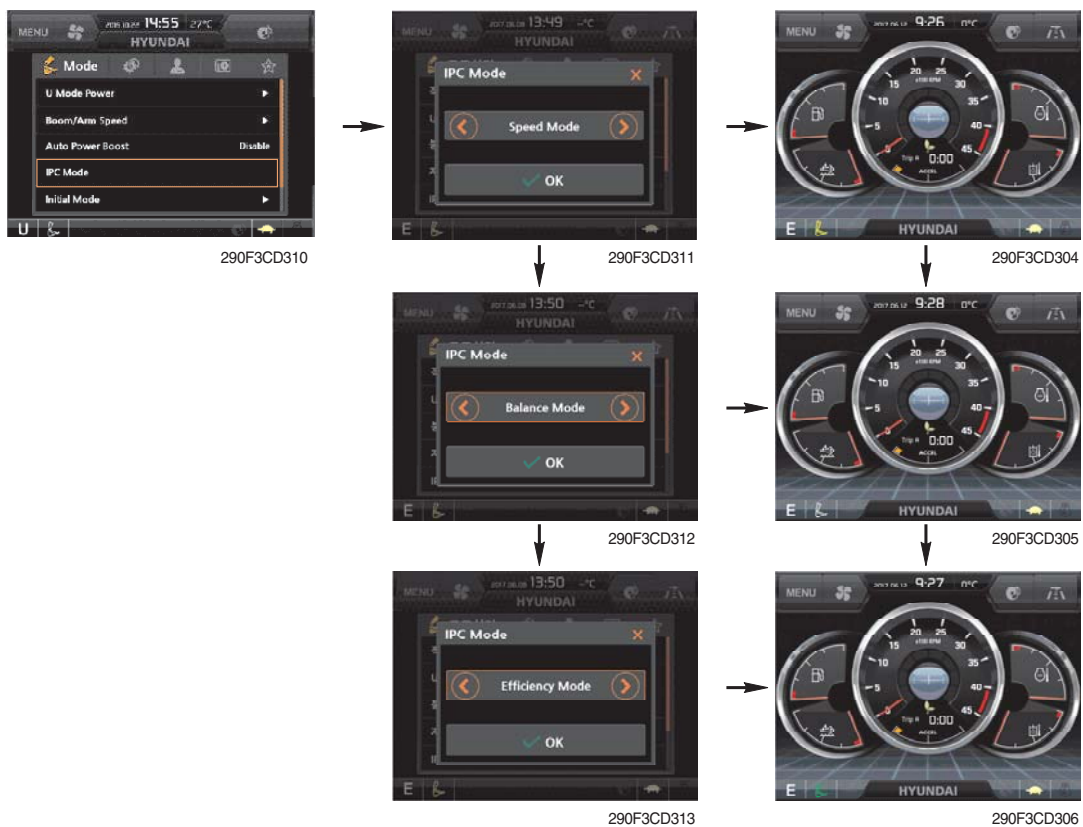

- The IPC mode can be selected by this menu.
 - Speed mode
 - Balance mode (default)
 - Efficiency mode
- This mode is applied only general operation mode of the work tool mode.
- ※ Please update the cluster programs if this mode is not displayed in the mode setup menu. Refer to the operator's manual page 3-25-1.

⑥ Automatic engine shutdown (option)



210WF3CD11



210WF3CD12



210WF3CD13

- The automatic engine shutdown function can be set by this menu.
 - One time
 - Always
 - Disable
 - Wait time setting : Max 40 minutes, min 2 minutes

⑦ Initial mode



290F3CD122



290F3CD119

- **Key on initial mode**
 - Selected the power mode is activated when the engine is started.
- **Accel initial mode**
 - Last setting value
 - User setting value
- **Accel initial step**
 - 0~9 step

⑧ Emergency mode



290F3CD248



290F3CD249

- This mode can be use when the switches are abnormal on the cluster.
- The cluster switches will be selected by touched each icon.

(3) Monitoring

① Active fault



- The active faults of the MCU or engine ECM can be checked by this menu.

② Logged fault



- The logged faults of the MCU or engine ECM can be checked by this menu.

③ Delete logged fault



- The logged faults of the MCU or engine ECM can be deleted by this menu.

④ Monitoring

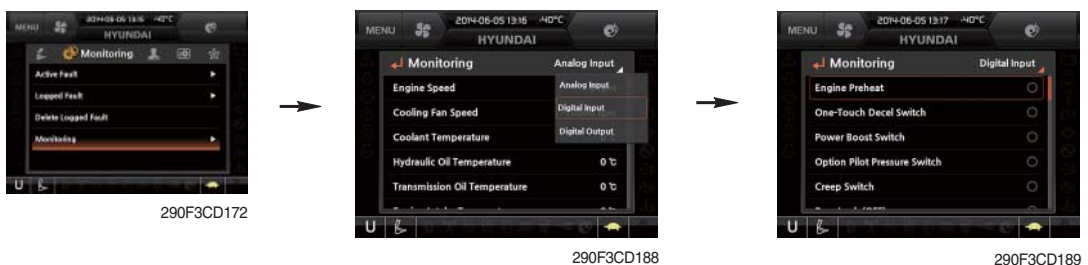

- The machine status such as the engine rpm, oil temperature, voltage and pressure etc. can be checked by this menu (Analog input).
- The switch status or output status can be confirmed by this menu (Digital input & Digital output).
- The activated switch or output pilot lamps ● are light ON.

(4) Management

① Fuel rate information



210WF3CD14



210WF3CD15

A



B



C



D



210WF3CD16

- **General record (A)**
 - Average fuel rate (left) (from "Reset" to now)
Fuel consumption divided by engine run time (service meter time).
 - A days fuel used (right)
Fuel consumption from 24:00 (or "Reset" time) to now (MCU real time).
- **Hourly record (B)**
 - Hourly fuel rates for past 12 hours (service meter time).
 - No record during key-off time.
 - One step shift to the right for every one hour.
 - Automatic deletion for 12 hours earlier data.
 - All hourly records deletion by "Reset".
- **Daily record (C)**
 - Daily fuel consumption for past seven days (MCU real time).
 - No record during key-off time.
 - One step shift to the right at 24:00 for every day.
 - Automatic deletion for 7 days earlier data.
 - All daily records deletion by "Reset".
- **Mode record (D)**
 - Average fuel rate for each power mode/accel dial (at least 7) from "Reset" to now.
 - No record during idle.
 - All mode records deletion by "Reset".

② Maintenance information



210WF3CD131



290F3CD132



290F3CD133

- Alarm lamp (●) is ON when oil or filter needs to be changed or replaced.
- Replacement : The elapsed time will be reset to zero (0).
- Change interval : The change or replace interval can be changed in the unit of 50 hours.
- **Change or replace interval**

No	Item	Interval
1	Engine oil	500
2	Final gear oil	1000
3	Swing gear oil	1000
4	Hydraulic oil	5000
5	Pilot line filter	1000
6	Drain filter	1000
7	Hydraulic oil return filter	1000
8	Engine oil filter	500
9	Fuel filter	500
10	Pre-filter	500
11	Hydraulic tank breather	1000
12	Air cleaner (inner & outer)	4000
13	Radiator coolant	2000
14	Swing gear pinion grease	1000
15	DEF (diesel particulate filter)	5000
16	Crankcase Breather Filter	2000
17	DEF/AdBlue® Tank Filter	4000

③ Machine security



· ESL mode setting

- ESL : Engine Starting Limit
- ESL mode is designed to be a theft deterrent or will prevent the unauthorized operation of the machine.
- When you Enable the ESL mode, the password will be required when the starting switch is turned to the on position.

- Machine security

Disable : ESL function is disabled and password is not required to start engine.

Enable (always) : The password is required whenever the operator starts engine.

- **Interval** : The password is required when the operator starts engine first. But the operator can restart the engine within the interval time without inputting the password. The interval time can be set to a maximum 4 hours.

※ Default password : 00000 + ✓

※ Password length : (5~10 digits) + ✓

- Smart key (option) : Refer to next page.

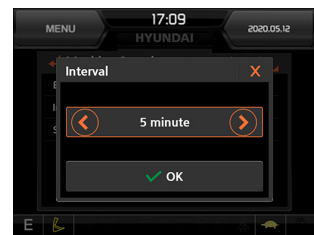
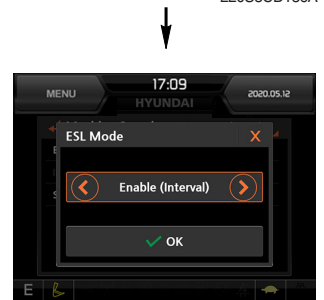

· Password change

- The password is 5~10 digits.



Enter the current password



Enter the new password again



Enter the new password

※ Before first use, please set user password and owner password in advance for machine security.

- Smart key



- Smart key is registered when equipped with optional smart key. If smart key is not inside of the cabin, authentication process fails and the password is needed.
- Tag management menu is activated when the Smart key menu is Enabled.
You can register and delete the tags.

- Tag management

- When registering a tag : Only the tag you want to register must be in the cabin.
- When deleting a tag : All registered tags are deleted.

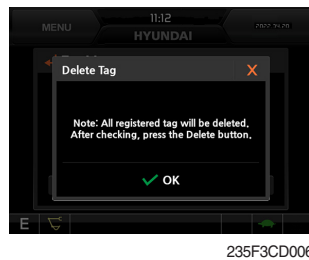
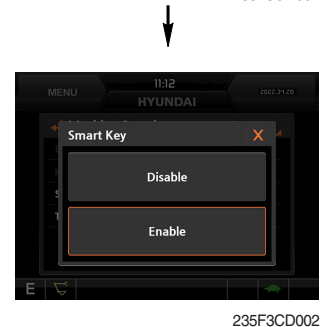

Deleting

Registering

④ Machine Information



- This can confirm the identification of the model information (ECU), MCU, monitor, haptic controller, switch controller, RMCU, relay driver unit, FATC (air conditioner controller), AAVM (opt).

⑤ Contact (A/S phone number)



Enter the new A/S phone number

⑥ Service menu



- Power shift (standard/option) : Power shift pressure can be set by option menu.
- Operating hours : Operating hours since the machine line out can be checked by this menu.
- Breaker mode pump acting (1 pump/2 pump)
- EPPR current level (attach flow EPPR 1 & 2, boom priority EPPR, attach relief pressure EPPR 1 & 2)
- Overload pressure : 100 ~ 350 bar

⑦ Clinometer

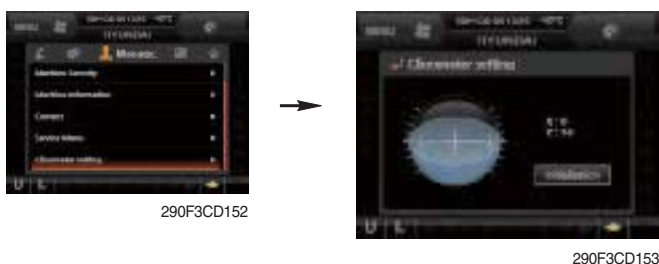

- When the machine is on the flatland, if tap the "initialization", the values of X, Y reset "0".
- You can confirm tilt of machine in cluster's operating screen.

⑧ Update (cluster & ETC devices)

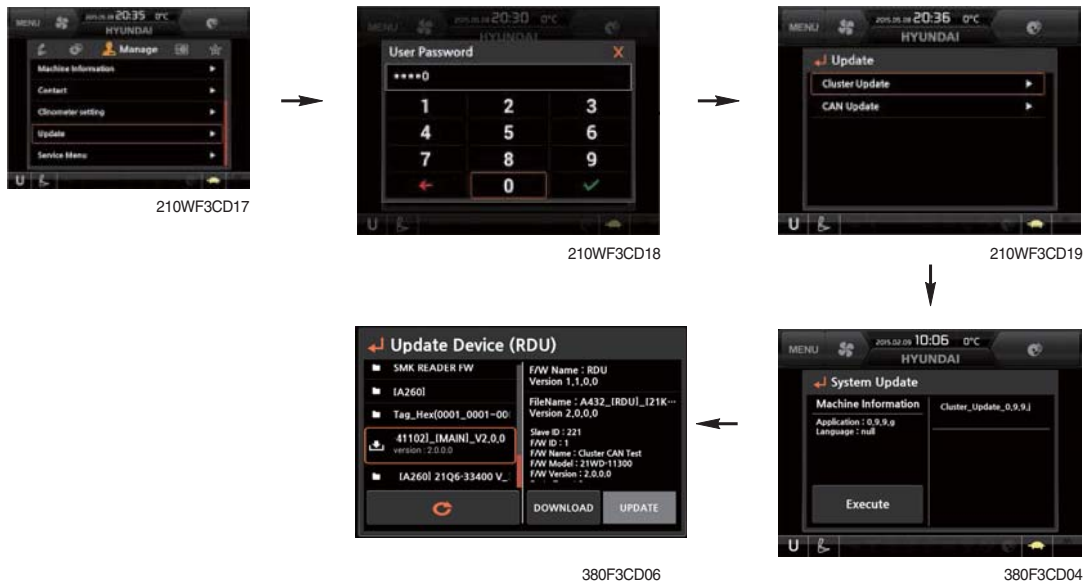

- ETC devices and cluster can be updated through CAN 2 network.
- Insert USB memory stick which includes program files, start download.

(5) Display

① Display item



290F3CD154



290F3CD155



290F3CD156

- The center display type of the LCD can be selected by this menu.
- The engine speed or each of the tripmeter (A,B,C) is displayed on the center display.

② Clock



290F3CD157



290F3CD158

- The first line's three spots "**/**/****" represent Month/Day/Year each.
- The second line shows the current time. (0:00~23:59)

③ Brightness



290F3CD159



290F3CD160



290F3CD139



290F3CD141



290F3CD191



290F3CD192

- If "Auto" is chosen, brightness for day and night can be differently set up. Also by using the bar in lower side, users can define which time interval belongs to day and night. (in bar figure, white area represents night time while orange shows day time)

④ Unit



290F3CD161



210WF3CD162



290F3CD193

- Temperature : °C ↔ °F
- Pressure : bar ↔ MPa ↔ kgf/cm²
- Volume : ℓ ↔ gal
- Flow : lpm ↔ gpm
- Distance : km ↔ mile
- Date format : yy/mm/dd ↔ mm/dd/yy ↔ dd-mm-yy

⑤ Language



290F3CD163



290F3CD164

- User can select preferable language and all displays are changed the selected language.

⑥ Screen type



290F3CD165



A Type (Default) 290F3CD166



290F3CD156A



B Type (Option) 290F3CD194



290F3CD167A

(6) Utilities

① Entertainment



290F3CD195



290F3CD196

A



210WF3CD219



290F3CD197

B



210WF3CD220



290F3CD198

C



210WF3CD199



210WF3CD22

- Video (A) : This menu operates the video play function.
mp4, mkv, avi files and so on.
- Audio (B) : This menu operates the play music.
mp3, mp4 files and so on.
- Smart terminal (C) : The menu features a smartphone and operates the miracast.

② Tripmeter

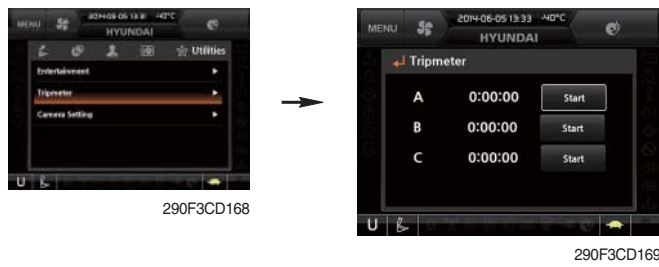

- Maximum 3 kinds of tripmeters can be used at the same time.
- Each tripmeter can be turned on by choosing "Start" while it also can be turned off by choosing "Stop".
- If the tripmeter icon is activated in the operation screen, it can be controlled directly there.

③ Camera setting

- If the rear camera is not installed on the machine, set disable.
- If the rear camera installed on the machine, set enable.



- In the operation screen, rear camera screen show up when ESC/CAM button is pushed.



3. AIR CONDITIONER AND HEATER

Full auto air conditioner and heater system automatically keeps the optimum condition in accordance with operator's temperature configuration sensing ambient and cabin inside temperature.

- Location of air flow ducts

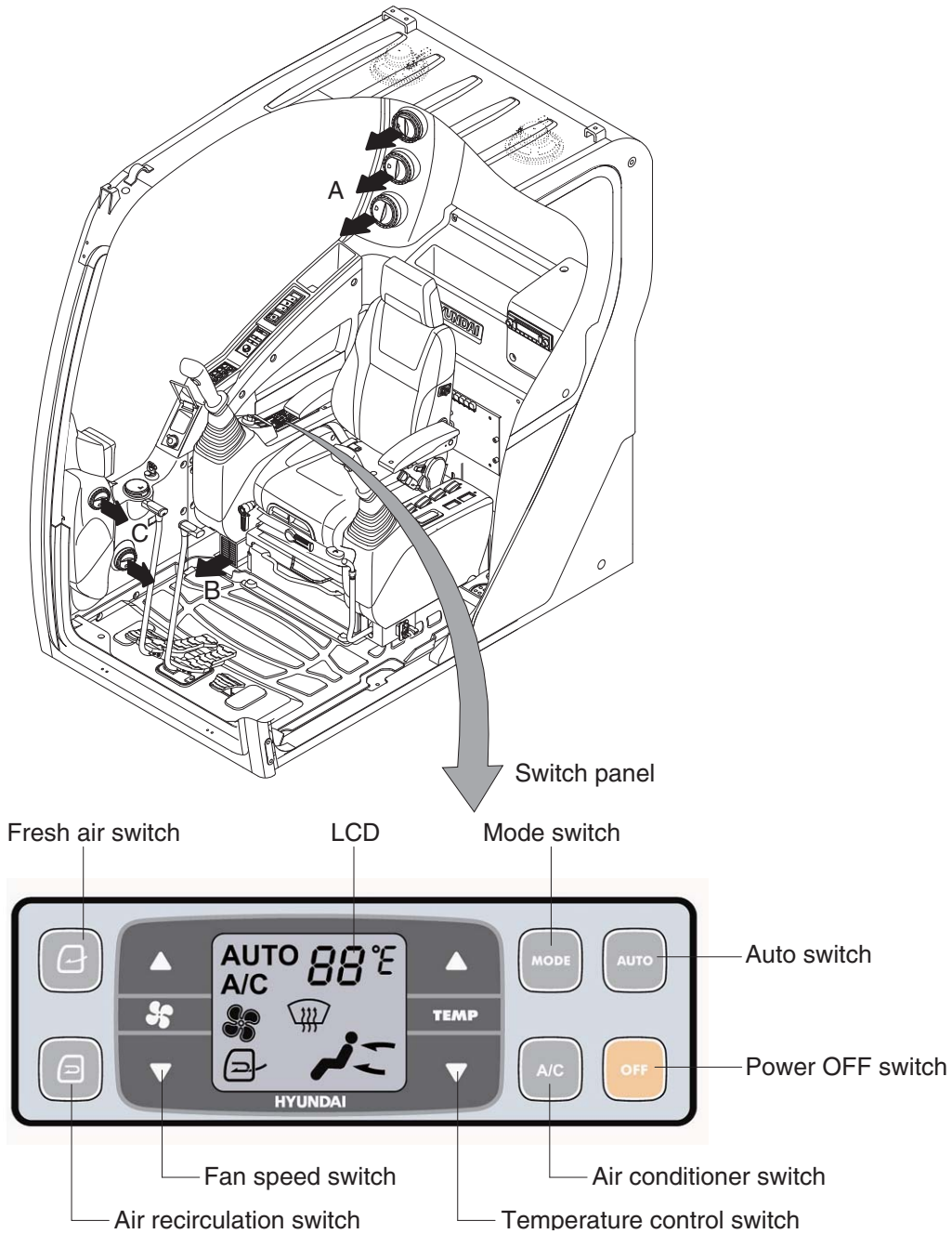

235F3CD06

1) POWER OFF SWITCH

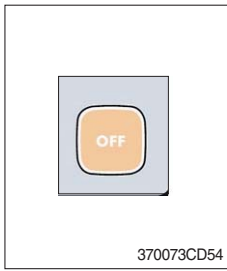

- (1) This switch makes the system and the LED OFF.
Just before the power OFF, set values are stored.

(2) Default setting values

Function	Air conditioner	In/outlet	LCD	Temperature	Mode
Value	OFF	Inlet	OFF	Previous sw OFF	Previous sw OFF

2) AUTO SWITCH

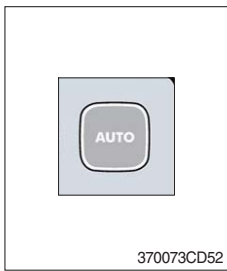

- (1) Turn the starting switch to ON position, LCD lights ON.
Auto air conditioner and heater system automatically keeps the optimum condition in accordance with operator's temperature configuration sensing ambient and cabin inside temperature.

- (2) This switch can restart system after system OFF.

3) AIR CONDITIONER SWITCH (COMPRESSOR SWITCH)

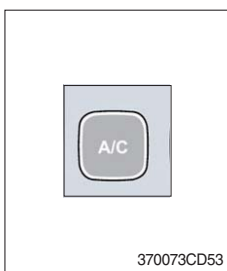

- (1) This switch turns the compressor and the LCD ON.
- (2) In accordance with the temperature sensed by duct (evaporator) sensor, compressor turns ON or OFF automatically.
- ※ **Air conditioner operates to remove vapor and drains water through a drain hose. Water can be sprayed into the cab in case that the drain cock at the ending point of drain hose has a problem.**

In this case, exchange the drain cock.

4) FAN SPEED SWITCH

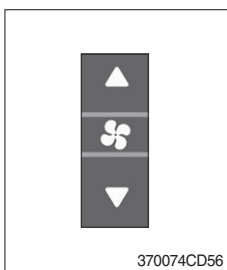

- (1) Fan speed is controlled automatically by setted temperature.
- (2) This switch controls fan speed manually.
- There are 8 up/down steps to control fan speed.
 - The maximum step or the minimum step beeps 5 times.
- (3) This switch makes the system ON.

5) TEMPERATURE CONTROL SWITCH

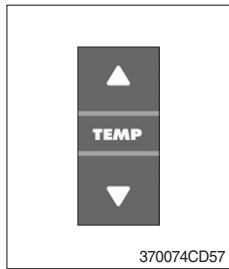

(1) Setting temperature indication

- ① Type A : 17~32°C, scale : 1°C
- ② Type B : Lo, 18~31°C, Hi, scale : 1°C

(2) Max cool and max warm beeps 5 times.

(3) The max cool or the max warm position operates as following table.

Temperature	Compressor	Fan speed	In/Outlet	Mode
Max cool	ON	Max (Hi)	Recirculation	Vent
Max warm	OFF	Max (Hi)	Fresh	Foot

(4) Temperature unit can be changed between celsius (°C) and fahrenheit (°F)

- ① Default status (°C)
- ② Push Up/Down temperature control switch simultaneously more than 5 second displayed temperature unit change (°C → °F)

6) MODE SWITCH

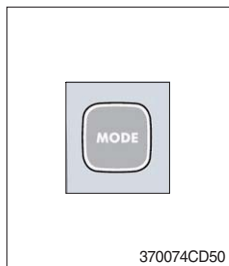

(1) Operating this switch, it beeps and displays symbol of each mode in order. (Vent → Vent/Foot → Def/Foot → Def/Vent → Def/Vent/Foot)

Mode switch		Vent	Vent/Foot	Def/Foot	Def/Vent	Def/Vent/Foot
Outlet	A	●	●		●	●
	B		●	●		●
	C			●	●	●

(2) When defroster mode operating, FRESH AIR/AIR RECIRCULATION switch turns to FRESH AIR mode and air conditioner switch turns ON.

7) FRESH AIR/AIR RECIRCULATION SWITCH

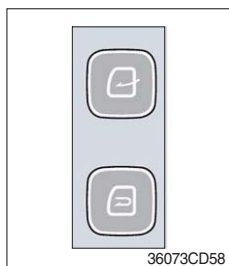

(1) It is possible to change the air-inlet method.

① **Fresh air** ()

Inhaling air from the outside.

※ **Check out the fresh air filter periodically to keep a good efficiency.**

② **Air recirculation** ()

It recycles the heated or cooled air to increase the energy efficiency.

※ **Change air occasionally when using recirculation for a long time.**

※ **Check out the recirculation filter periodically to keep a good efficiency.**

8) SELF DIAGNOSIS FUNCTION

(1) Procedure

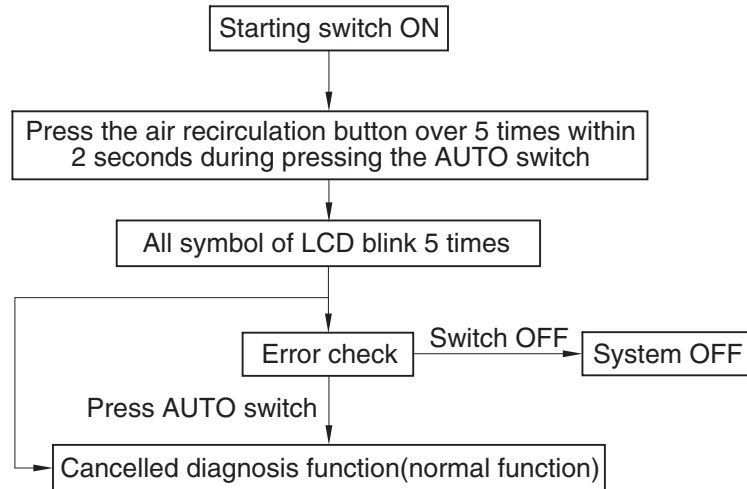

3607A3CD69

(2) Error check

- The corresponding error code flickers on the setup temperature display panel, the other symbol will turn OFF.
- Error code flickers every 0.5 second.
- If error code is more than two, each code flickers 2 times in sequence.
- Error code

Error code	Description	Error code	Description
11	Cabin inside sensor	16	Mode actuator 1
12	Ambient sensor	17	Mode actuator 2
14	Duct (evaporator) sensor	18	Intake actuator
15	Temp actuator	-	-

(3) Fail safe function

Error description	Fail safe function
Cabin inside sensor (11)	25°C alternate value control
Ambient sensor (12)	20°C alternate value control
Duct (evaporator) sensor (14)	1°C alternate value control
Temp actuator (15)	If opening amount is 0 %, the alternate value is 0 %
	If not, the alternate value is 100 %
Mode actuator 1, 2 (16, 17)	The alternate value is vent

GROUP 17 FUEL WARMER SYSTEM

1. SPECIFICATION

- 1) Operating voltage : 24 ± 4 V
- 2) Power : 350 ± 50 W
- 3) Current : 15 A

2. OPERATION

- 1) The current of fuel warmer system is automatically controlled without thermostat according to fuel temperature.
- 2) At the first state, the 15 A current flows to the fuel warmer and engine may be started in 1~2 minutes.
- 3) If the fuel starts to flow, ceramic-disk in the fuel warmer heater senses the fuel temperature to reduce the current as low as 1.5 A.
So, fuel is protected from overheating by this mechanism.

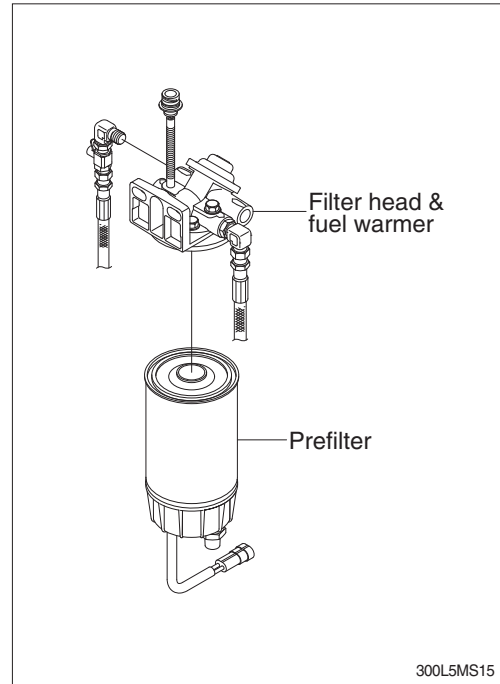

3. ELECTRIC CIRCUIT

