

SECTION 1 GENERAL



Group 1 Safety Hints	1-1
Group 2 Specifications	1-10

SECTION 1 GENERAL

GROUP 1 SAFETY

FOLLOW SAFE PROCEDURE

Unsafe work practices are dangerous. Understand service procedure before doing work; Do not attempt shortcuts.

WEAR PROTECTIVE CLOTHING

Wear close fitting clothing and safety equipment appropriate to the job.

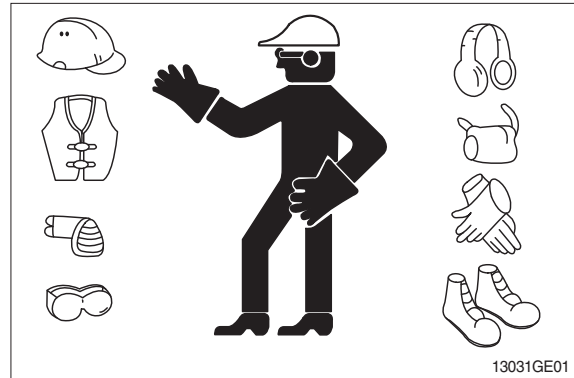

WARN OTHERS OF SERVICE WORK

Unexpected machine movement can cause serious injury.

Before performing any work on the excavator, attach a 「Do Not Operate」 tag on the right side control lever.

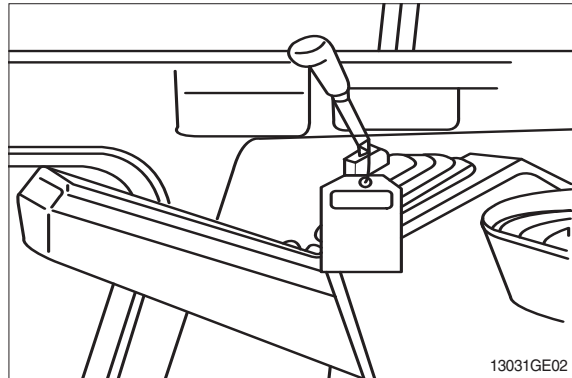

USE HANDHOLDS AND STEPS

Falling is one of the major causes of personal injury.

When you get on and off the machine, always maintain a three point contact with the steps and handrails and face the machine. Do not use any controls as handholds.

Never jump on or off the machine. Never mount or dismount a moving machine.

Be careful of slippery conditions on platforms, steps, and handrails when leaving the machine.

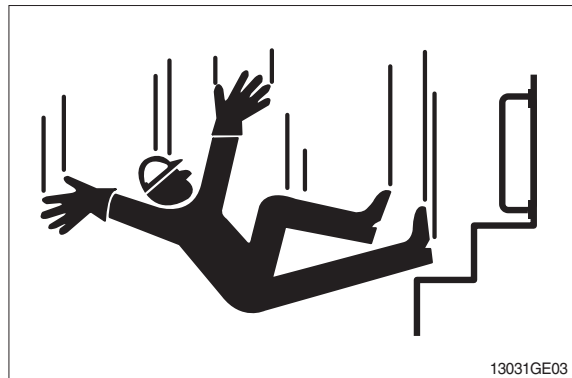

PREPARE FOR EMERGENCIES

Be prepared if a fire starts.

Keep a first aid kit and fire extinguisher handy.

Keep emergency numbers for doctors, ambulance service, hospital, and fire department near your telephone.

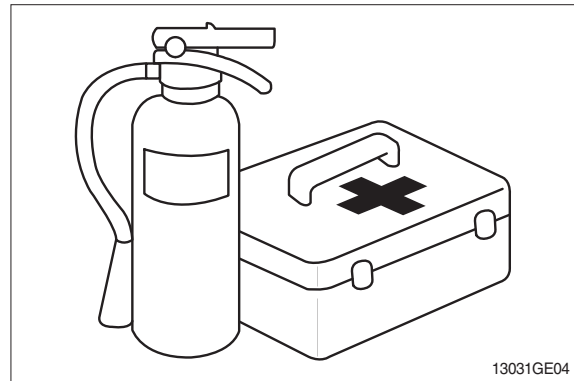

PROTECT AGAINST FLYING DEBRIS

Guard against injury from flying pieces of metal or debris; Wear goggles or safety glasses.

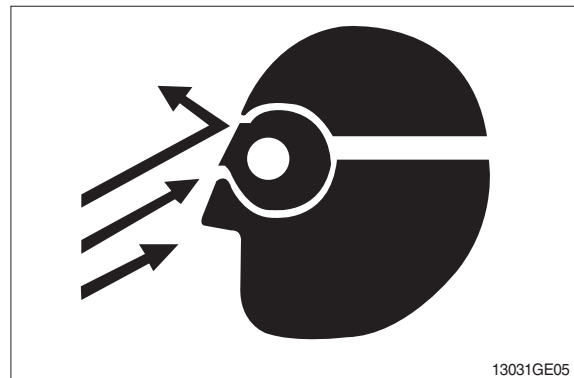

PROTECT AGAINST NOISE

Prolonged exposure to loud noise can cause impairment or loss of hearing.

Wear a suitable hearing protective device such as earmuffs or earplugs to protect against objectionable or uncomfortable loud noises.



AVOID POWER LINES

Serious injury or death can result from contact with electric lines.

Never move any part of the machine or load closer to electric line than 3 m (10 ft) plus twice the line insulator length.

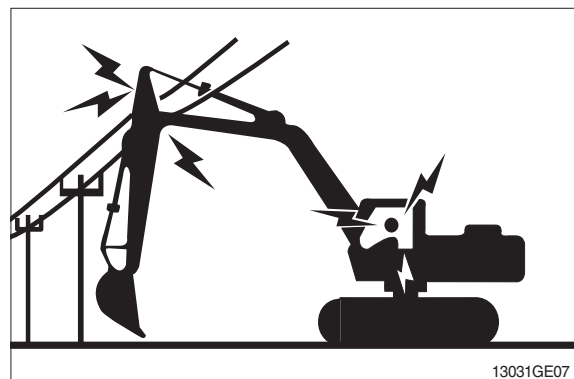

KEEP RIDERS OFF EXCAVATOR

Only allow the operator on the excavator. Keep riders off.

Riders on excavator are subject to injury such as being struck by foreign objects and being thrown off the excavator. Riders also obstruct the operator's view resulting in the excavator being operated in an unsafe manner.

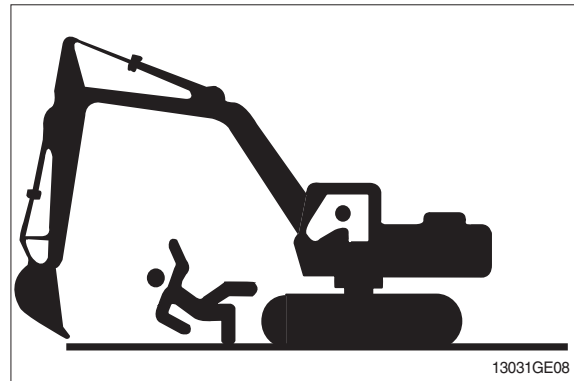

MOVE AND OPERATE MACHINE SAFELY

Bystanders can be run over. Know the location of bystanders before moving, swinging, or operating the machine.

Always keep the travel alarm in working condition. It warns people when the excavator starts to move.

Use a signal person when moving, swinging, or operating the machine in congested areas. Coordinate hand signals before starting the excavator.

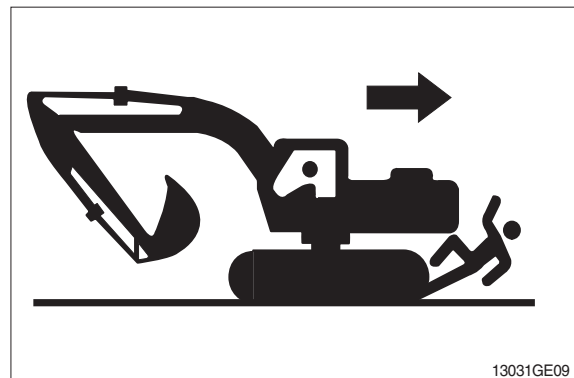

OPERATE ONLY FROM OPERATOR'S SEAT

Avoid possible injury machine damage. Do not start engine by shorting across starter terminals.

NEVER start engine while standing on ground. Start engine only from operator's seat.



PARK MACHINE SAFELY

Before working on the machine:

- Park machine on a level surface.
- Lower bucket to the ground.
- Turn auto idle switch off.
- Run engine at 1/2 speed without load for 2 minutes.
- Turn key switch to OFF to stop engine. Remove key from switch.
- Move pilot control shutoff lever to locked position.
- Allow engine to cool.

SUPPORT MACHINE PROPERLY

Always lower the attachment or implement to the ground before you work on the machine. If you must work on a lifted machine or attachment, securely support the machine or attachment.

Do not support the machine on cinder blocks, hollow tiles, or props that may crumble under continuous load.

Do not work under a machine that is supported solely by a jack. Follow recommended procedures in this manual.

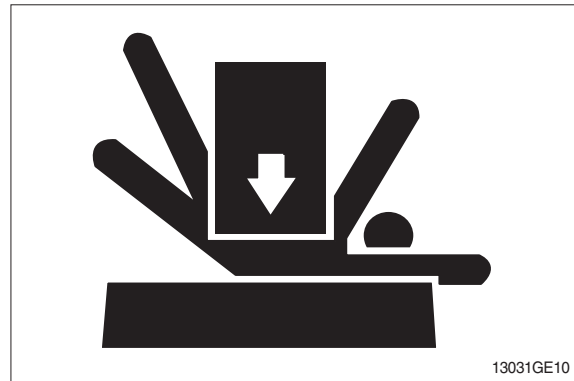

SERVICE COOLING SYSTEM SAFELY

Explosive release of fluids from pressurized cooling system can cause serious burns.

Shut off engine. Only remove filler cap when cool enough to touch with bare hands.



HANDLE FLUIDS SAFELY-AVOID FIRES

Handle fuel with care; It is highly flammable. Do not refuel the machine while smoking or when near open flame or sparks. Always stop engine before refueling machine. Fill fuel tank outdoors.

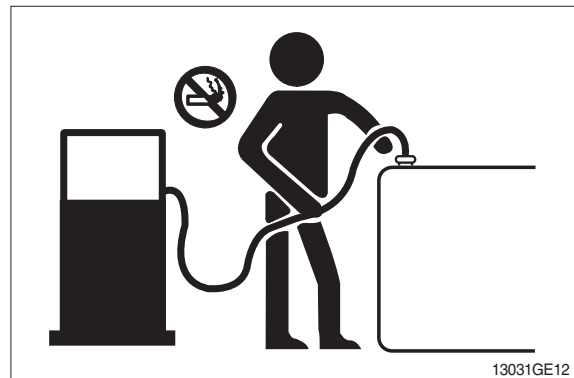

Store flammable fluids away from fire hazards. Do not incinerate or puncture pressurized containers.

Make sure machine is clean of trash, grease, and debris.

Do not store oily rags; They can ignite and burn spontaneously.



BEWARE OF EXHAUST FUMES

Prevent asphyxiation. Engine exhaust fumes can cause sickness or death.

If you must operate in a building, be positive there is adequate ventilation. Either use an exhaust pipe extension to remove the exhaust fumes or open doors and windows to bring enough outside air into the area.

REMOVE PAINT BEFORE WELDING OR HEATING

Avoid potentially toxic fumes and dust.

Hazardous fumes can be generated when paint is heated by welding, soldering, or using a torch.

Do all work outside or in a well ventilated area. Dispose of paint and solvent properly.

Remove paint before welding or heating:

- If you sand or grind paint, avoid breathing the dust.
Wear an approved respirator.
- If you use solvent or paint stripper, remove stripper with soap and water before welding. Remove solvent or paint stripper containers and other flammable material from area. Allow fumes to disperse at least 15 minutes before welding or heating.

ILLUMINATE WORK AREA SAFELY

Illuminate your work area adequately but safely. Use a portable safety light for working inside or under the machine. Make sure the bulb is enclosed by a wire cage. The hot filament of an accidentally broken bulb can ignite spilled fuel or oil.

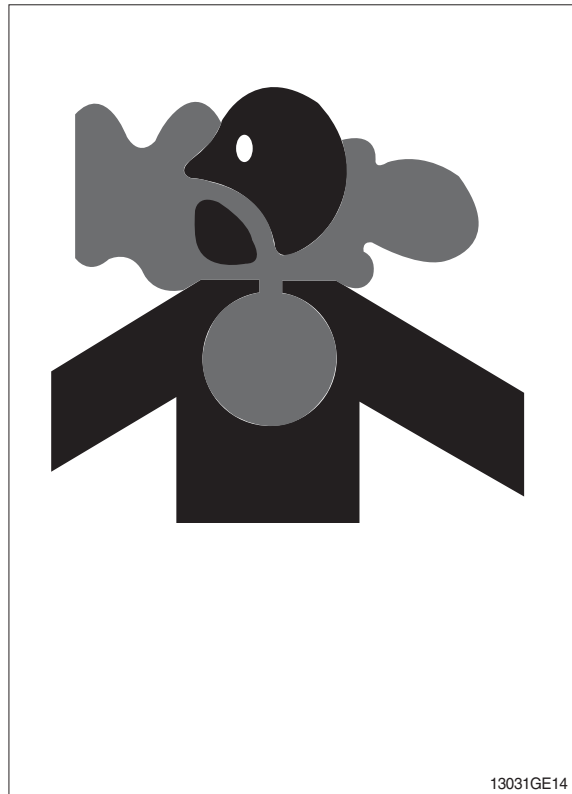

SERVICE MACHINE SAFELY

Tie long hair behind your head. Do not wear a necktie, scarf, loose clothing or necklace when you work near machine tools or moving parts. If these items were to get caught, severe injury could result.

Remove rings and other jewelry to prevent electrical shorts and entanglement in moving parts.

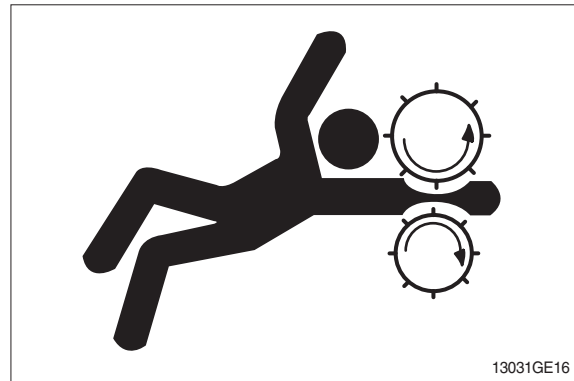

STAY CLEAR OF MOVING PARTS

Entanglements in moving parts can cause serious injury.

To prevent accidents, use care when working around rotating parts.

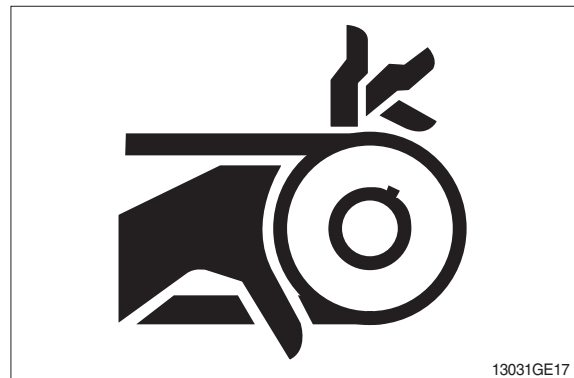

AVOID HIGH PRESSURE FLUIDS

Escaping fluid under pressure can penetrate the skin causing serious injury.

Avoid the hazard by relieving pressure before disconnecting hydraulic or other lines. Tighten all connections before applying pressure.

Search for leaks with a piece of cardboard. Protect hands and body from high pressure fluids.

If an accident occurs, see a doctor immediately. Any fluid injected into the skin must be surgically removed within a few hours or gangrene may result.

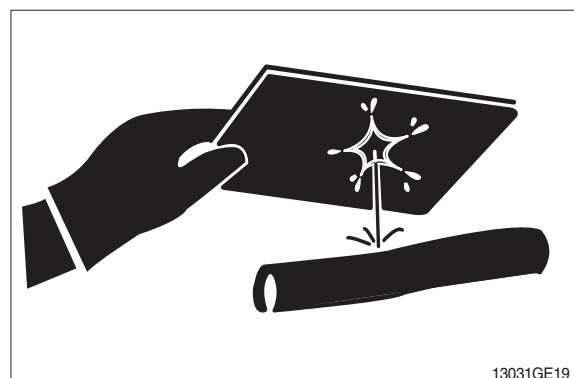

AVOID HEATING NEAR PRESSURIZED FLUID LINES

Flammable spray can be generated by heating near pressurized fluid lines, resulting in severe burns to yourself and bystanders. Do not heat by welding, soldering, or using a torch near pressurized fluid lines or other flammable materials.

Pressurized lines can be accidentally cut when heat goes beyond the immediate flame area. Install fire resisting guards to protect hoses or other materials.



PREVENT BATTERY EXPLOSIONS

Keep sparks, lighted matches, and flame away from the top of battery. Battery gas can explode.

Never check battery charge by placing a metal object across the posts. Use a volt-meter or hydrometer.

Do not charge a frozen battery; It may explode. Warm battery to 16°C (60°F).



PREVENT ACID BURNS

Sulfuric acid in battery electrolyte is poisonous. It is strong enough to burn skin, eat holes in clothing, and cause blindness if splashed into eyes.

Avoid the hazard by:

1. Filling batteries in a well-ventilated area.
2. Wearing eye protection and rubber gloves.
3. Avoiding breathing fumes when electrolyte is added.
4. Avoiding spilling or dripping electrolyte.
5. Use proper jump start procedure.

If you spill acid on yourself:

1. Flush your skin with water.
2. Apply baking soda or lime to help neutralize the acid.
3. Flush your eyes with water for 10-15 minutes. Get medical attention immediately.

If acid is swallowed:

1. Drink large amounts of water or milk.
2. Then drink milk of magnesia, beaten eggs, or vegetable oil.
3. Get medical attention immediately.

USE TOOLS PROPERLY

Use tools appropriate to the work. Makeshift tools, parts, and procedures can create safety hazards.

Use power tools only to loosen threaded tools and fasteners.

For loosening and tightening hardware, use the correct size tools. **DO NOT** use U.S. measurement tools on metric fasteners. Avoid bodily injury caused by slipping wrenches.

Use only recommended replacement parts. (See Parts catalogue.)

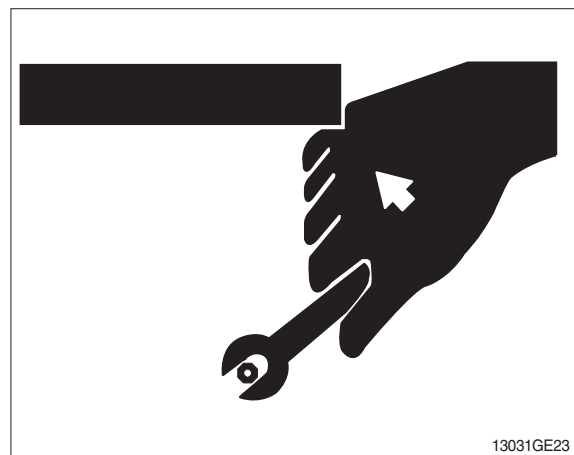
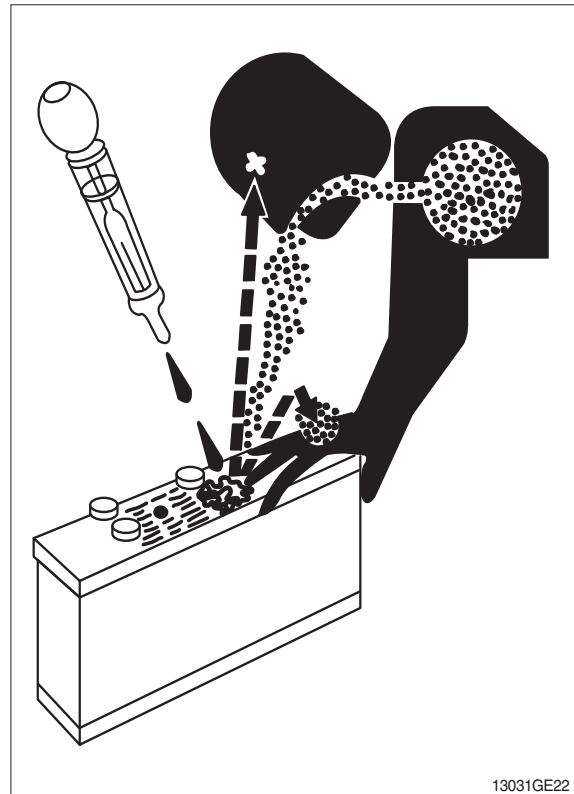

DISPOSE OF FLUIDS PROPERLY

Improperly disposing of fluids can harm the environment and ecology. Before draining any fluids, find out the proper way to dispose of waste from your local environmental agency.

Use proper containers when draining fluids. Do not use food or beverage containers that may mislead someone into drinking from them.

DO NOT pour oil into the ground, down a drain, or into a stream, pond, or lake. Observe relevant environmental protection regulations when disposing of oil, fuel, coolant, brake fluid, filters, batteries, and other harmful waste.

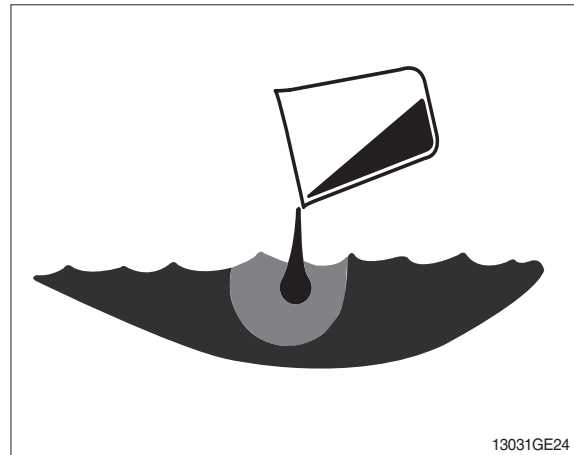

REPLACE SAFETY SIGNS

Replace missing or damaged safety signs. See the machine operator's manual for correct safety sign placement.

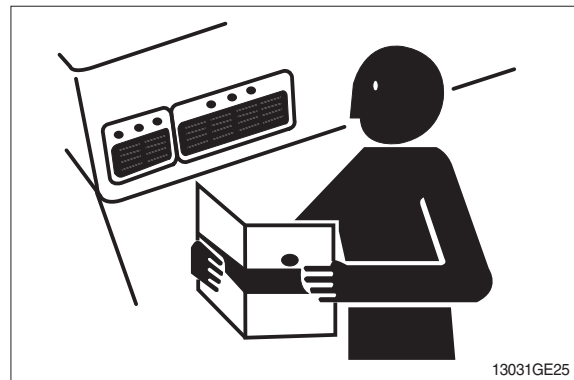

LIVE WITH SAFETY

Before returning machine to customer, make sure machine is functioning properly, especially the safety systems. Install all guards and shields.

GROUP 2 SPECIFICATIONS

1. MAJOR COMPONENT

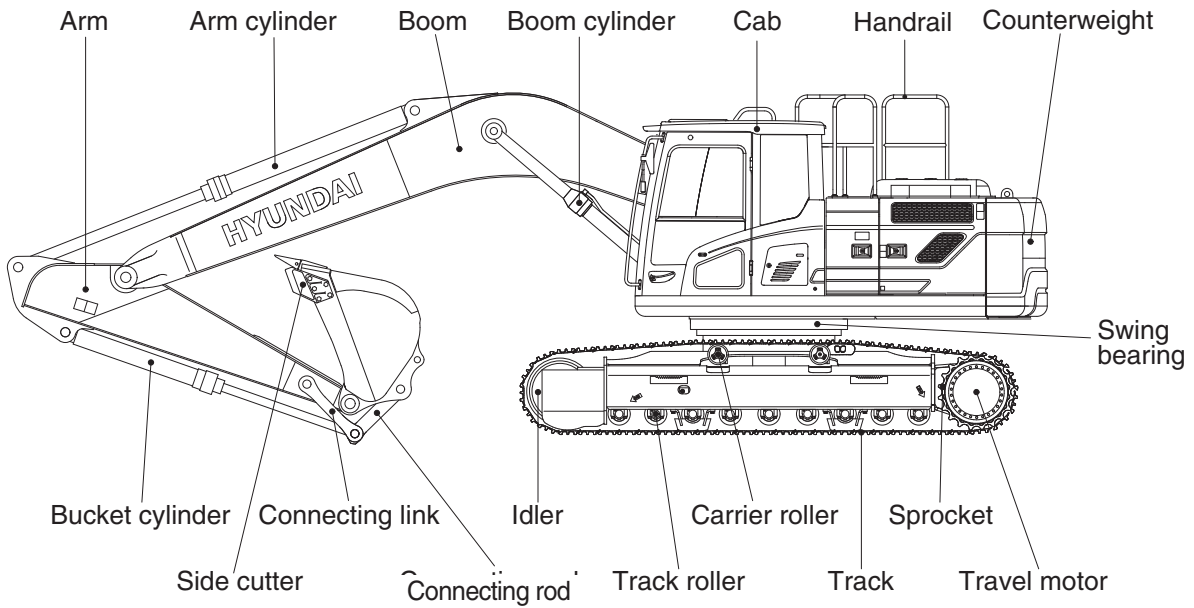
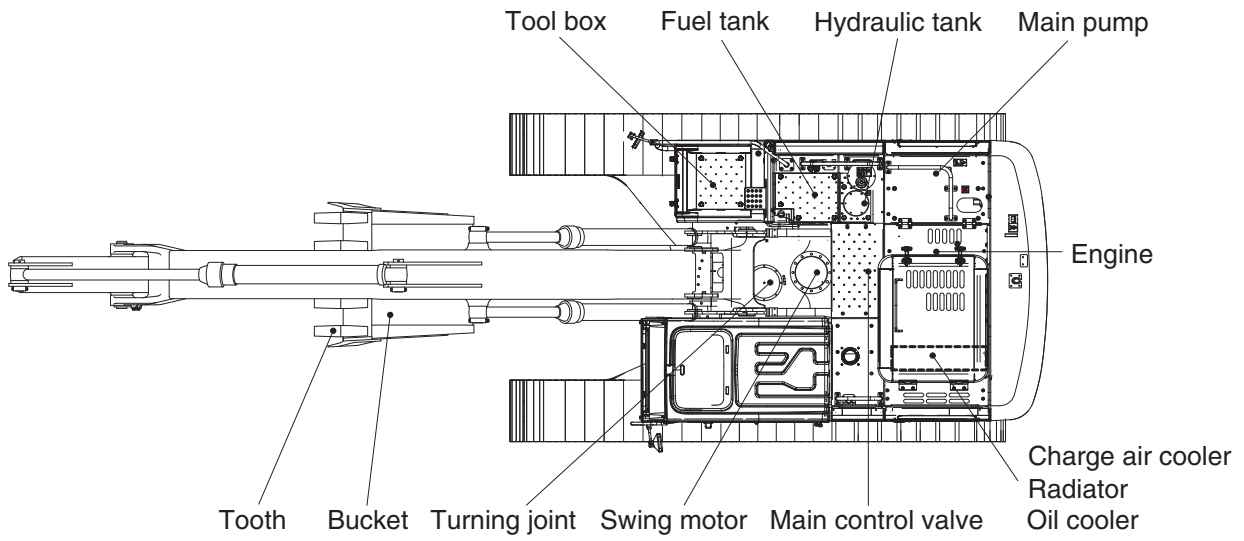

220S2SP01

2. SPECIFICATIONS

1) HX225S L

- 5.68 m (18' 8") BOOM and 2.92 m (9' 7") ARM

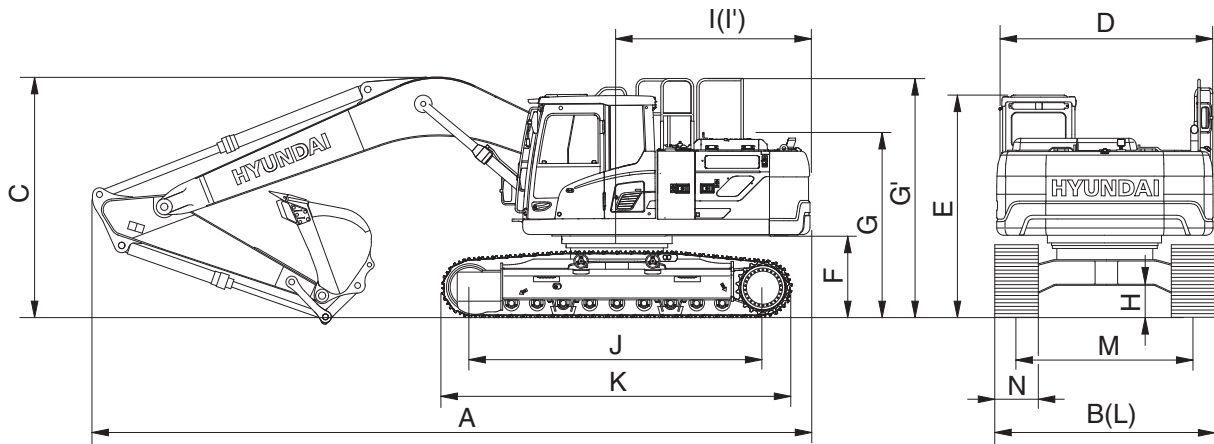

225S2SP02

Description		Unit	Specification
Operating weight		kg (lb)	22070 (48660)
Bucket capacity (SAE heaped), standard		m ³ (yd ³)	0.92 (1.20)
Overall length	A	mm (ft-in)	9530 (31' 3")
Overall width, with 600mm shoe	B		2990 (9' 10")
Overall height of boom	C		3030 (9' 11")
Superstructure width	D		2740 (9' 0")
Overall height of cab	E		3030 (9' 11")
Ground clearance of counterweight	F		1060 (3' 6")
Engine cover height	G		2470 (8' 1")
Overall height of guardrail	G'		3213 (10' 6")
Minimum ground clearance	H		480 (1' 7")
Rear-end distance	I		2770 (9' 1")
Rear-end swing radius	I'		2890 (9' 5")
Distance between tumblers	J		3650 (12' 0")
Undercarriage length	K		4440 (14' 6")
Undercarriage width	L		2990 (9' 10")
Track gauge	M		2390 (7' 10")
Track shoe width, standard	N		600 (2' 0")
Travel speed (low/high)		km/hr (mph)	3.6/5.4 (2.23/3.35)
Swing speed		rpm	12.6
Gradeability		Degree (%)	35 (70)
Ground pressure (600 mm shoe)		kgf/cm ² (psi)	0.47 (6.68)
Max traction force		kg (lb)	20200 (44530)

2) HX225S L LONG REACH

· 8.2 m (26' 11") BOOM and 6.3 m (20' 8") ARM

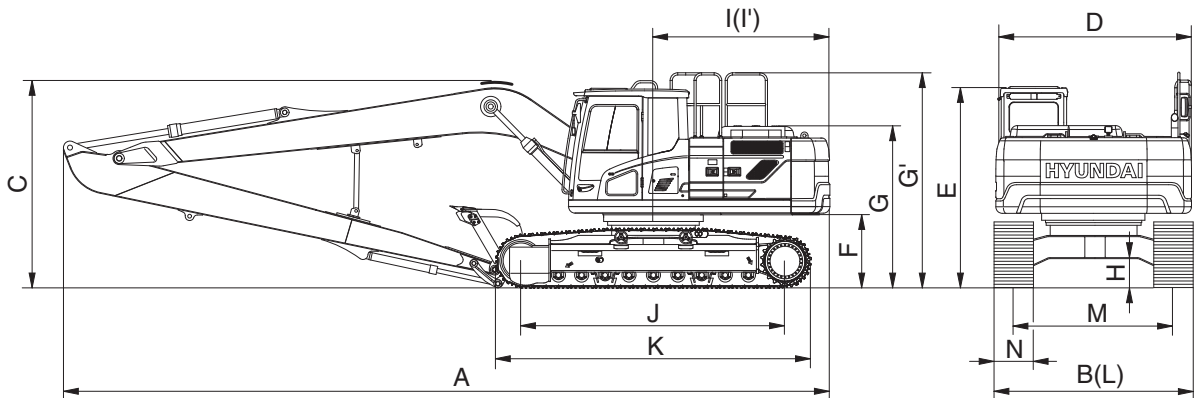

220S2SP03

Description		Unit	Specification
Operating weight		kg (lb)	24830 (54740)
Bucket capacity (SAE heaped), standard		m ³ (yd ³)	0.52 (0.68)
Overall length	A	mm (ft-in)	12030 (39' 6")
Overall width, with 800 mm shoe	B		3190 (10' 6")
Overall height	C		3280 (10' 9")
Superstructure width	D		2740 (9' 0")
Overall height of cab	E		3030 (9' 11")
Ground clearance of counterweight	F		1060 (3' 6")
Engine cover height	G		2470 (8' 1")
Overall height of guardrail	G'		3213 (10' 6")
Minimum ground clearance	H		480 (1' 7")
Rear-end distance	I		2770 (9' 1")
Rear-end swing radius	I'		2890 (9' 5")
Distance between tumblers	J		3650 (12' 0")
Undercarriage length	K		4440 (14' 6")
Undercarriage width	L		3190 (10' 6")
Track gauge	M		2390 (7' 10")
Track shoe width	N		800 (2' 6")
Travel speed (low/high)		km/hr (mph)	3.6/5.4 (2.23/3.35)
Swing speed		rpm	12.6
Gradeability		Degree (%)	35 (70)
Ground pressure (800 mm shoe)		kgf/cm ² (psi)	0.40 (5.64)
Max traction force		kg (lb)	20200 (44530)

3) HX225S L HIGH WALKER

· 5.68 m (18' 8") BOOM and 2.92 m (9' 7") ARM

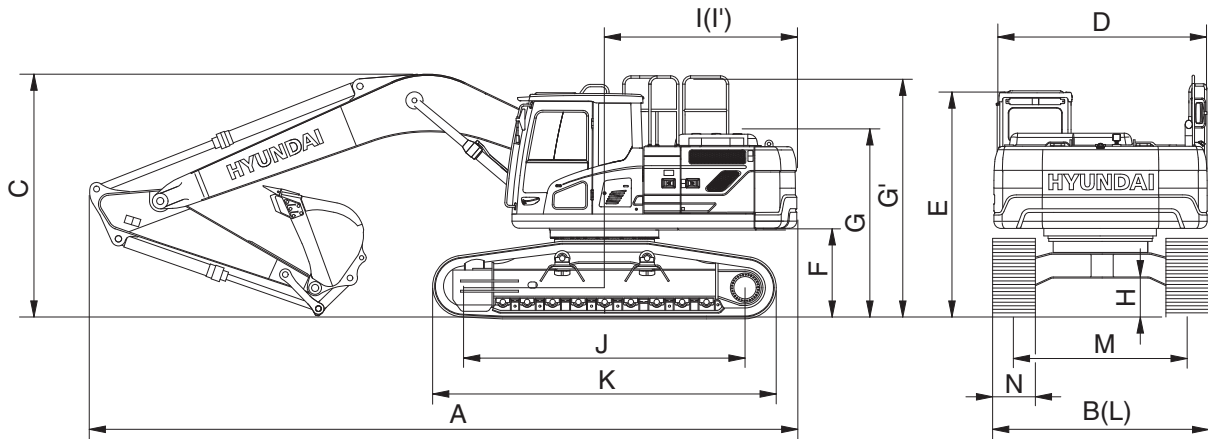

220S2SP04

Description	Unit	Specification
Operating weight	kg (lb)	24300 (53570)
Bucket capacity (SAE heaped), standard	m ³ (yd ³)	0.92 (1.20)
Overall length	A	9470 (31' 1")
Overall width, with 600 mm shoe	B	3395 (11' 2")
Overall height	C	3060 (10' 0")
Superstructure width	D	2740 (9' 0")
Overall height of cab	E	3230 (10' 7")
Ground clearance of counterweight	F	1260 (4' 1")
Engine cover height	G	2670 (8' 8")
Overall height of guardrail	G'	3413 (11' 2")
Minimum ground clearance	H	660 (2' 2")
Rear-end distance	I	2770 (9' 1")
Rear-end swing radius	I'	2890 (9' 5")
Distance between tumbler	J	3650 (12' 0")
Undercarriage length	K	4440 (14' 6")
Undercarriage width	L	3395 (11' 2")
Track gauge	M	2795 (9' 2")
Track shoe width, standard	N	600 (2' 0")
Travel speed (low/high)	km/hr (mph)	3.6/5.4 (2.23/3.35)
Swing speed	rpm	12.6
Gradeability	Degree (%)	35 (70)
Ground pressure (600 mm shoe)	kgf/cm ² (psi)	0.52 (7.36)
Max traction force	kg (lb)	20200 (44530)

3. WORKING RANGE

1) HX225S L

· 5.68 m (18' 8") BOOM

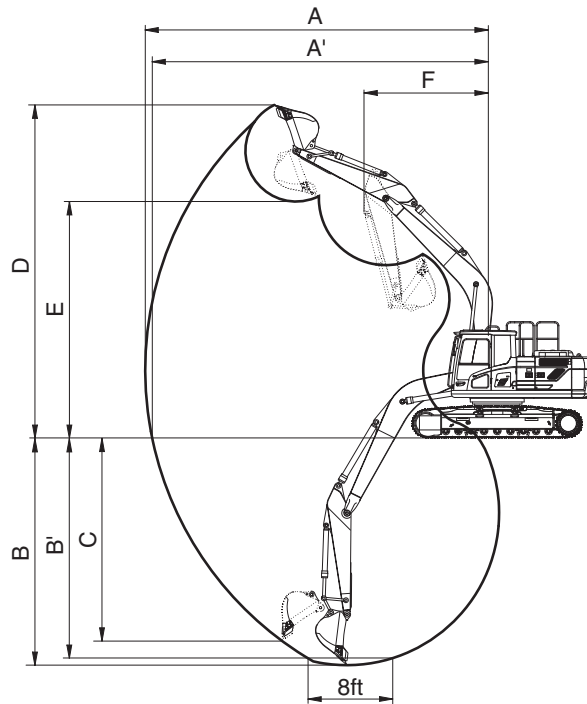

220S2SP05

Description		2.0 m (6' 7") Arm	2.40 m (7' 10") Arm	2.92 m (9' 7") Arm	3.90 m (12' 10") Arm
Max digging reach	A	9140 mm (30' 0")	9500 mm (31' 2")	9980 mm (32' 9")	10910 mm (35' 10")
Max digging reach on ground	A'	8960 mm (29' 5")	9330 mm (30' 7")	9820 mm (32' 3")	10770 mm (35' 4")
Max digging depth	B	5820 mm (19' 1")	6220 mm (20' 5")	6730 mm (22' 1")	7720 mm (25' 4")
Max digging depth (8 ft level)	B'	5580 mm (18' 4")	6010 mm (19' 9")	6560 mm (21' 6")	7580 mm (24' 10")
Max vertical wall digging depth	C	5280 mm (17' 4")	5720 mm (18' 9")	6280 mm (20' 7")	7240 mm (23' 9")
Max digging height	D	9140 mm (30' 0")	9340 mm (30' 8")	9600 mm (31' 6")	10110 mm (33' 2")
Max dumping height	E	6330 mm (20' 9")	6520 mm (21' 5")	6780 mm (22' 3")	7290 mm (23' 11")
Min swing radius	F	3750 mm (12' 4")	3740 mm (12' 3")	3740 mm (12' 3")	3650 mm (12' 0")
Bucket digging force	SAE	133.4 [144.8] kN	133.4 [144.8] kN	133.4 [144.8] kN	133.4 [144.8] kN
		13600 [14770] kgf	13600 [14770] kgf	13600 [14770] kgf	13600 [14770] kgf
		29980 [32550] lbf	29980 [32550] lbf	29980 [32550] lbf	29980 [32550] lbf
	ISO	152.0 [165.0] kN	152.0 [165.0] kN	152.0 [165.0] kN	152.0 [165.0] kN
		15500 [16830] kgf	15500 [16830] kgf	15500 [16830] kgf	15500 [16830] kgf
		34170 [37100] lbf	34170 [37100] lbf	34170 [37100] lbf	34170 [37100] lbf
Arm digging force	SAE	144.2 [156.5] kN	119.6 [129.9] kN	102.0 [110.7] kN	84.3 [91.6] kN
		14700 [15960] kgf	12200 [13250] kgf	10400 [11290] kgf	8600 [9340] kgf
		32410 [35190] lbf	26900 [29210] lbf	22930 [24900] lbf	18960 [20590] lbf
	ISO	151.0 [164.0] kN	125.5 [136.3] kN	106.9 [116.1] kN	87.3 [94.8] kN
		15400 [16720] kgf	12800 [13900] kgf	10900 [11830] kgf	8900 [9660] kgf
		33950 [36860] lbf	28220 [30640] lbf	24030 [26090] lbf	19620 [21300] lbf

[] : Power boost

2) HX225S L LONG REACH

· 8.2 m (26' 11") BOOM

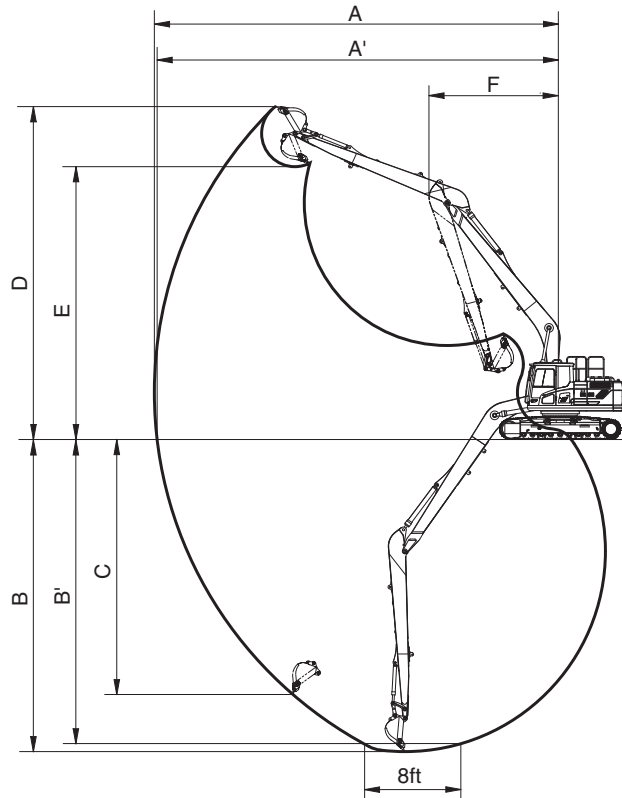

220S2SP06

Description		6.3 m (20' 8") Arm	
Max digging reach	A	15220 (50' 0")	
Max digging reach on ground	A'	15120 (49' 7")	
Max digging depth	B	11760 (38' 7")	
Max digging depth (8 ft level)	B'	11650 (38' 3")	
Max vertical wall digging depth	C	9610 (31' 6")	
Max digging height	D	12550 (41' 2")	
Max dumping height	E	10280 (33' 8")	
Min swing radius	F	4870 (16' 0")	
Bucket digging force	SAE	72.6 kN	
		7400 kgf	
		16310 lbf	
	ISO	83.4 kN	
		8500 kgf	
		18740 lbf	
Arm crowd force	SAE	49.0 kN	
		5000 kgf	
		11020 lbf	
	ISO	50.0 kN	
		5100 kgf	
		11240 lbf	

3) HX225S L HIGH WALKER

· 5.68 m (18' 8") BOOM

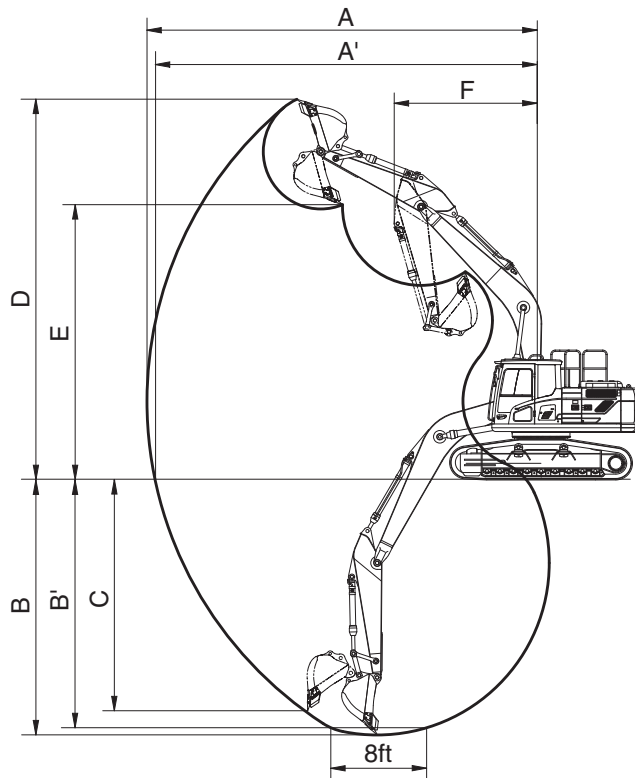

220S2SP07

Description		2.0 m (6' 7") Arm	2.40 m (7' 10") Arm	2.92 m (9' 7") Arm	3.90 m (12'10") Arm
Max digging reach	A	9140 mm (30' 0")	9500 mm (31' 2")	9980 mm (32' 9")	10910 mm (35'10")
Max digging reach on ground	A'	8920 mm (29' 3")	9290 mm (30' 6")	9820 mm (32' 3")	10730 mm (35' 2")
Max digging depth	B	5630 mm (18' 6")	6010 mm (19' 9")	6550 mm (21' 6")	7530 mm (24' 8")
Max digging depth (8 ft level)	B'	5390 mm (17' 8")	5820 mm (19' 1")	6380 mm (20'11")	7390 mm (24' 3")
Max vertical wall digging depth	C	5090 mm (16' 8")	5630 mm (18' 6")	6100 mm (20' 0")	7050 mm (23' 1")
Max digging height	D	9330 mm (30' 7")	9530 mm (31' 3")	9780 mm (32' 1")	10300 mm (33' 9")
Max dumping height	E	6520 mm (21' 5")	6710 mm (22' 0")	6960 mm (22'10")	7480 mm (24' 6")
Min swing radius	F	3750 mm (12' 4")	3740 mm (12' 3")	3740 mm (12' 3")	3650 mm (12' 0")
Bucket digging force	SAE	133.4 [144.8] kN	133.4 [144.8] kN	133.4 [144.8] kN	133.4 [144.8] kN
		13600 [14770] kgf	13600 [14770] kgf	13600 [14770] kgf	13600 [14770] kgf
		29980 [32550] lbf	29980 [32550] lbf	29980 [32550] lbf	29980 [32550] lbf
	ISO	152.0 [165.0] kN	152.0 [165.0] kN	152.0 [165.0] kN	152.0 [165.0] kN
		15500 [16830] kgf	15500 [16830] kgf	15500 [16830] kgf	15500 [16830] kgf
		34170 [37100] lbf	34170 [37100] lbf	34170 [37100] lbf	34170 [37100] lbf
Arm crowd force	SAE	144.2 [156.5] kN	119.6 [129.9] kN	102.0 [110.7] kN	84.3 [91.6] kN
		14700 [15960] kgf	12200 [13250] kgf	10400 [11290] kgf	8600 [9340] kgf
		32410 [35190] lbf	26900 [29210] lbf	22930 [24900] lbf	18960 [20590] lbf
	ISO	151.0 [164.0] kN	125.5 [136.3] kN	106.9 [116.1] kN	87.3 [94.8] kN
		15400 [16720] kgf	12800 [13900] kgf	10900 [11830] kgf	8900 [9660] kgf
		33950 [36860] lbf	28220 [30640] lbf	24030 [26090] lbf	19620 [21300] lbf

[] : Power boost

4. WEIGHT

1) HX225S L

Item	HX225S L	
	kg	lb
Upperstructure assembly	9650	21270
Main frame weld assembly	1880	4140
Engine assembly	432	953
Main pump assembly	146	322
Main control valve assembly	220	485
Swing motor assembly	254	560
Hydraulic oil and fuel tank assembly	480	1058
Counterweight	3800	8380
Cab assembly	422	930
Lower chassis assembly	8060	17770
Track frame weld assembly	2545	5611
Swing bearing	290	640
Travel motor assembly	305	672
Turning joint	57	125
Sprocket	56	123
Track recoil spring	140	309
Idler	151	333
Carrier roller	21	46
Track roller	48	106
Track-chain assembly (600 mm standard triple grouser shoe)	1360	3000
Front attachment assembly (5.68 m boom, 2.92 m arm, 0.92 m ³ SAE heaped bucket)	4030	8880
5.68 m boom assembly	1520	3350
2.92 m arm assembly	750	1650
0.92 m ³ SAE heaped bucket	765	1690
Boom cylinder assembly	198	436
Arm cylinder assembly	273	602
Bucket cylinder assembly	161	355
Bucket control linkage total	200	441

2) HX225S L LONG REACH

Item	HX225S L LONG REACH	
	kg	lb
Upperstructure assembly	11150	24852
Main frame weld assembly	1880	4140
Engine assembly	432	953
Main pump assembly	146	322
Main control valve assembly	220	485
Swing motor assembly	254	560
Hydraulic oil and fuel tank assembly	480	1058
Counterweight	5300	11680
Cab assembly	422	930
Lower chassis assembly	8815	19434
Track frame weld assembly	2545	5611
Swing bearing	290	640
Travel motor assembly	305	672
Turning joint	57	125
Sprocket	56	123
Track recoil spring	140	309
Idler	151	333
Carrier roller	21	46
Track roller	48	106
Track-chain assembly (800 mm standard triple grouser shoe)	1735	3825
Front attachment assembly (8.2 m boom, 6.3 m arm, 0.52 m ³ SAE heaped bucket)	4600	10140
8.2 m boom assembly	2105	4640
6.3 m arm assembly	1100	2430
0.52 m ³ SAE heaped bucket	465	1030
Boom cylinder assembly	198	436
Arm cylinder assembly	273	602
Bucket cylinder assembly	161	355
Bucket control linkage total	132	291

3) HX225S L HIGH WALKER

Item	HX225S L HIGH WALKER	
	kg	lb
Upperstructure assembly	9686	21354
Main frame weld assembly	1950	4300
Engine assembly	432	953
Main pump assembly	146	322
Main control valve assembly	220	485
Swing motor assembly	254	560
Hydraulic oil and fuel tank assembly	480	1058
Counterweight	3800	8380
Cab assembly	422	930
Lower chassis assembly	10246	22589
Track frame weld assembly	3610	7960
Swing bearing	295	650
Travel motor assembly	305	672
Turning joint	57	125
Sprocket	56	123
Track recoil spring	163	360
Idler	151	333
Carrier roller	48	106
Track roller	48	106
Track-chain assembly (600 mm standard triple grouser shoe)	1451	3200
Front attachment assembly (5.68 m boom, 2.92 m arm, 0.92 m ³ SAE heaped bucket)	4030	8880
5.68 m boom assembly	1520	3350
2.92 m arm assembly	750	1650
0.92 m ³ SAE heaped bucket	765	1690
Boom cylinder assembly	198	436
Arm cylinder assembly	273	602
Bucket cylinder assembly	161	355
Bucket control linkage total	200	441

5. LIFTING CAPACITIES

1) HX225S L









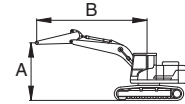

Unit : mm

Model	Boom	Boom	Arm	Counterweight	Shoe	Dozer		Outrigger	
	Type	Length	Length	Weight (kg)	Width	Front	Rear	Front	Rear
HX225S L	Mono	5680	2000	3800	600	-	-	-	-

·  : Rating over-front

·  : Rating over-side or 360 degree



Lift-point height (A)	Lift-point radius (B)								At max. reach			
	3.0 m (9.8 ft)		4.5 m (14.8 ft)		6.0 m (19.7 ft)		7.5 m (24.6 ft)		Capacity		Reach	
											m (ft)	
7.5m 24.6ft	kg									*5580	*5580	5.00
	lb									*12300	*12300	(16.4)
6.0m 19.7ft	kg				*5360	5000				*5440	4540	6.35
	lb				*11820	11020				*11990	10010	(20.8)
4.5m 14.8ft	kg		*6750	*6750	*5710	4880				*5500	3720	7.14
	lb		*14880	*14880	*12590	10760				*12130	8200	(23.4)
3.0m 9.8ft	kg		*8580	7030	*6460	4680	5260	3380		5210	3350	7.55
	lb		*18920	15500	*14240	10320	11600	7450		11490	7390	(24.8)
1.5m 4.9ft	kg				7200	4500	5190	3320		5060	3240	7.64
	lb				15870	9920	11440	7320		11160	7140	(25.1)
0.0m 0.0ft	kg		*10520	6610	7100	4420				5240	3340	7.43
	lb		*23190	14570	15650	9740				11550	7360	(24.4)
-1.5m -4.9ft	kg		*10260	6670	7130	4440				5880	3740	6.88
	lb		*22620	14700	15720	9790				12960	8250	(22.6)
-3.0m -9.8ft	kg	*12540	*12540	*9210	6860					*6740	4720	5.91
	lb	*27650	*27650	*20300	15120					*14860	10410	(19.4)
-4.5m -14.8ft	kg											
	lb											

※ Note

- Lifting capacity are based on SAE J1097 and ISO 10567.
- Lifting capacity of the ROBEX series does not exceed 75% of tipping load with the machine on firm, level ground or 87% of full hydraulic capacity.
- The lift-point is bucket mounting pin on the arm (without bucket).
- *indicates load limited by hydraulic capacity.

※ Lifting capacities are based upon a standard machine conditions.

Lifting capacities will vary with different work tools, ground conditions and attachments.

The difference between the weight of a work tool attachment must be subtracted.

Consult your Hyundai dealer regarding the lifting capacities for specific work tools and attachments.

▲ Failure to comply to the rated load can cause possible personal injury or property damage.

Make adjustments to the rated load as necessary for non-standard configurations.









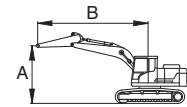

Unit : mm

Model	Boom	Boom	Arm	Counterweight	Shoe	Dozer		Outrigger	
	Type	Length	Length	Weight (kg)	Width	Front	Rear	Front	Rear
HX225S L	Mono	5680	2400	3800	600	-	-	-	-

·  : Rating over-front

·  : Rating over-side or 360 degree



Lift-point height (A)		Lift-point radius (B)								At max. reach		
		3.0 m (9.8 ft)		4.5 m (14.8 ft)		6.0 m (19.7 ft)		7.5 m (24.6 ft)		Capacity		Reach
												m (ft)
7.5m 24.6ft	kg lb									*5080 *11200	*5080 *11200	5.58 (18.3)
6.0m 19.7ft	kg lb					*4900 *10800	*4900 *10800			*4620 *10190	4070 8970	6.81 (22.4)
4.5m 14.8ft	kg lb			*6190 *13650	*6190 *13650	*5350 *11790	4900 10800	*4990 *11000	3440 7580	*4490 *9900	3400 7500	7.55 (24.8)
3.0m 9.8ft	kg lb			*8020 *17680	7110 15670	*6150 *13560	4690 10340	5250 11570	3370 7430	*4580 *10100	3090 6810	7.94 (26.1)
1.5m 4.9ft	kg lb			*9640 *21250	6710 14790	*6970 *15370	4490 9900	5160 11380	3290 7250	4680 10320	2990 6590	8.03 (26.3)
0.0m 0.0ft	kg lb			*10390 *22910	6560 14460	7070 15590	4380 9660	5110 11270	3250 7170	4820 10630	3070 6770	7.83 (25.7)
-1.5m -4.9ft	kg lb	*10820 *23850	*10820 *23850	*10360 *22840	6590 14530	7060 15560	4380 9660			5340 11770	3390 7470	7.31 (24.0)
-3.0m -9.8ft	kg lb	*13400 *29540	13220 29150	*9560 *21080	6740 14860	*7020 *15480	4500 9920			*6350 *14000	4150 9150	6.41 (21.0)
-4.5m -9.8ft	kg lb			*7270 *16030	7090 15630					*6430 *14180	6320 13930	4.89 (16.0)

Unit : mm

Model	Boom	Boom	Arm	Counterweight	Shoe	Dozer		Outrigger	
	Type	Length	Length	Weight (kg)	Width	Front	Rear	Front	Rear
HX225S L	Mono	5680	2920	3800	600	-	-	-	-



: Rating over-front



: Rating over-side or 360 degree

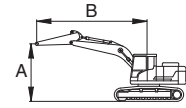

Lift-point height (A)		Lift-point radius (B)										At max. reach		
		1.5 m (4.9 ft)		3.0 m (9.8 ft)		4.5 m (14.8 ft)		6.0 m (19.7 ft)		7.5 m (24.6 ft)		Capacity	Reach	
														m (ft)
7.5m	kg							*4440	*4440			*3370	*3370	6.26
24.6ft	lb							*9790	*9790			*7430	*7430	(20.5)
6.0m	kg							*4340	*4340			*3100	*3100	7.38
19.7ft	lb							*9570	*9570			*6830	*6830	(24.2)
4.5m	kg							*4850	*4850	*4640	3460	*3020	*3020	8.07
14.8ft	lb							*10690	*10690	*10230	7630	*6660	*6660	(26.5)
3.0m	kg					*7270	7230	*5700	4710	*5010	3360	*3070	2790	8.43
9.8ft	lb					*16030	15940	*12570	10380	*11050	7410	*6770	6150	(27.7)
1.5m	kg					*9050	6750	*6610	4480	5130	3260	*3250	2700	8.51
4.9ft	lb					*19950	14880	*14570	9880	11310	7190	*7170	5950	(27.9)
0.0m	kg			*5920	*5920	*10100	6510	7020	4340	5050	3180	*3590	2770	8.32
0.0ft	lb			*13050	*13050	*22270	14350	15480	9570	11130	7010	*7910	6110	(27.3)
-1.5m	kg	*6500	*6500	*10390	*10390	*10360	6480	6970	4290	5050	3180	*4200	3010	7.84
-4.9ft	lb	*14330	*14330	*22910	*22910	*22840	14290	15370	9460	11130	7010	*9260	6640	(25.7)
-3.0m	kg	*11110	*11110	*14290	12930	*9870	6590	7050	4360			*5420	3580	7.01
-9.8ft	lb	*24490	*24490	*31500	28510	*21760	14530	15540	9610			*11950	7890	(23.0)
-4.5m	kg			*11780	*11780	*8290	6850					*6160	4990	5.66
-14.8ft	lb			*25970	*25970	*18280	15100					*13580	11000	(18.6)

2) HX225S L LONG REACH

Unit : mm

Model	Boom	Boom	Arm	Counterweight	Shoe	Dozer		Outrigger	
	Type	Length	Length	Weight (kg)	Width	Front	Rear	Front	Rear
HX225S L	Mono	8200	6300	5300	800	-	-	-	-



: Rating over-front



: Rating over-side or 360 degree

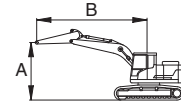

Lift-point height (A)		Lift-point radius (B)														At max. reach		
		4.5 m (14.8 ft)		6.0 m (19.7 ft)		7.5 m (24.6 ft)		9.0 m (29.5 ft)		10.5 m (34.4 ft)		12.0 m (39.4 ft)		13.5 m (44.3 ft)		Capacity	Reach	
																		m (ft)
10.5m	kg									*1230	*1230					*910	*910	10.88
34.4ft	lb									*2710	*2710					*2010	*2010	(35.7)
9.0m	kg															*860	*860	11.94
29.5ft	lb															*1900	*1900	(39.2)
7.5m	kg									*1920	*1920	*1450	*1450			*840	*840	12.74
24.6ft	lb									*4230	*4230	*3200	*3200			*1850	*1850	(41.8)
6.0m	kg									*2040	*2040	*1820	*1820			*830	*830	13.31
19.7ft	lb									*4500	*4500	*4010	*4010			*1830	*1830	(43.7)
4.5m	kg							*2340	*2340	*2220	*2220	*2120	1980	*1090	*1090	*840	*840	13.70
14.8ft	lb							*5160	*5160	*4890	*4890	*4670	4370	*2400	*2400	*1850	*1850	(45.0)
3.0m	kg					*3030	*3030	*2680	*2680	*2450	2410	*2300	1900	*1380	*1380	*870	*870	13.92
9.8ft	lb					*6680	*6680	*5910	*5910	*5400	5310	*5070	4190	*3040	*3040	*1920	*1920	(45.7)
1.5m	kg	*6400	*6400	*4530	*4530	*3600	*3600	*3050	2900	*2700	2270	*2470	1810	*1530	1450	*920	*920	13.97
4.9ft	lb	*14110	*14110	*9990	*9990	*7940	*7940	*6720	6390	*5950	5000	*5450	3990	*3370	3200	*2030	*2030	(45.8)
0.0m	kg	*6310	*6310	*5330	4740	*4120	3510	*3400	2710	*2940	2140	*2640	1720	*1520	1400	*990	*990	13.85
0.0ft	lb	*13910	*13910	*11750	10450	*9080	7740	*7500	5970	*6480	4720	*5820	3790	*3350	3090	*2180	*2180	(45.5)
-1.5m	kg	*5640	*5640	*5910	4420	*4540	3280	*3700	2550	*3160	2040	2740	1660	*1220	*1220	*1090	*1090	13.57
-4.9ft	lb	*12430	*12430	*13030	9740	*10010	7230	*8160	5620	*6970	4500	6040	3660	*2690	*2690	*2400	*2400	(44.5)
-3.0m	kg	*6090	*6090	*6260	4240	*4820	3140	*3920	2450	3250	1970	2690	1610			*1230	*1230	13.11
-9.8ft	lb	*13430	*13430	*13800	9350	*10630	6920	*8640	5400	7170	4340	5930	3550			*2710	*2710	(43.0)
-4.5m	kg	*7050	6340	*6380	4180	*4960	3070	3980	2390	3220	1930	*2430	1610			*1440	*1440	12.45
-14.8ft	lb	*15540	13980	*14070	9220	*10930	6770	8770	5270	7100	4250	*5360	3550			*3170	*3170	(40.9)
-6.0m	kg	*8460	6440	*6290	4210	*4930	3080	3990	2400	3240	1950					*1760	1730	11.56
-19.7ft	lb	*18650	14200	*13870	9280	*10870	6790	8800	5290	7140	4300					*3880	3810	(37.9)
-7.5m	kg	*7850	6630	*5930	4320	*4680	3160	*3770	2470							*2340	2070	10.37
-24.6ft	lb	*17310	14620	*13070	9520	*10320	6970	*8310	5450							*5160	4560	(34.0)
-9.0m	kg	*6810	*6810	*5190	4520	*4060	3320									*3240	2720	8.77
-29.5ft	lb	*15010	*15010	*11440	9960	*8950	7320									*7140	6000	(28.8)
-10.5m	kg																	
-34.4ft	lb																	

※ Note

1. Lifting capacity are based on SAE J1097 and ISO 10567.
2. Lifting capacity of the ROBEX series does not exceed 75% of tipping load with the machine on firm, level ground or 87% of full hydraulic capacity.
3. The lift-point is bucket mounting pin on the arm (without bucket).
4. *indicates load limited by hydraulic capacity.

※ Lifting capacities are based upon a standard machine conditions.

Lifting capacities will vary with different work tools, ground conditions and attachments.

The difference between the weight of a work tool attachment must be subtracted.

Consult your Hyundai dealer regarding the lifting capacities for specific work tools and attachments.

▲ Failure to comply to the rated load can cause possible personal injury or property damage.

Make adjustments to the rated load as necessary for non-standard configurations.

3) HX225S L HIGH WALKER









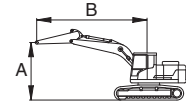

Unit : mm

Model	Boom	Boom	Arm	Counterweight	Shoe	Dozer		Outrigger	
	Type	Length	Length	Weight (kg)	Width	Front	Rear	Front	Rear
HX225S L	Mono	5680	2000	3800	600	-	-	-	-

·  : Rating over-front

·  : Rating over-side or 360 degree



Lift-point height (A)		Lift-point radius (B)								At max. reach		
		3.0 m (9.8 ft)		4.5 m (14.8 ft)		6.0 m (19.7 ft)		7.5 m (24.6 ft)		Capacity		Reach
												kg
7.5m	kg									*5540	*5540	5.23
24.6ft	lb									*12210	*12210	(17.1)
6.0m	kg					*5360	*5360			*5440	*5440	6.48
19.7ft	lb					*11820	*11820			*11990	*11990	(21.3)
4.5m	kg			*6970	*6970	*5800	*5800			*5520	4760	7.21
14.8ft	lb			*15370	*15370	*12790	*12790			*12170	10490	(23.7)
3.0m	kg			*8820	*8820	*6570	6100	*5700	4420	5680	4360	7.58
9.8ft	lb			*19440	*19440	*14480	13450	*12570	9740	12520	4360	(24.9)
1.5m	kg					*7300	5930	5700	4360	5560	4260	7.63
4.9ft	lb					*16090	13070	12570	9610	12260	9390	(25.0)
0.0m	kg			*10520	8920	*7700	5860			5820	4450	7.37
0.0ft	lb			*23190	19670	*16980	12920			12830	9810	(24.2)
-1.5m	kg	*12400	*12400	*10180	9000	*7570	5900			*6510	5030	6.78
-4.9ft	lb	*27340	*27340	*22440	19840	*16690	13010			*14350	11090	(22.2)
-3.0m	kg	*12210	*12210	*8970	*8970					*6760	6500	5.73
-9.8ft	lb	*26920	*26920	*19780	*19780					*14900	14330	(18.8)
-4.5m	kg											
-14.8ft	lb											

※ Note

1. Lifting capacity are based on SAE J1097 and ISO 10567.
2. Lifting capacity of the ROBEX series does not exceed 75% of tipping load with the machine on firm, level ground or 87% of full hydraulic capacity.
3. The lift-point is bucket mounting pin on the arm (without bucket).
4. *indicates load limited by hydraulic capacity.

※ Lifting capacities are based upon a standard machine conditions.

Lifting capacities will vary with different work tools, ground conditions and attachments.

The difference between the weight of a work tool attachment must be subtracted.

Consult your Hyundai dealer regarding the lifting capacities for specific work tools and attachments.

▲ Failure to comply to the rated load can cause possible personal injury or property damage.

Make adjustments to the rated load as necessary for non-standard configurations.









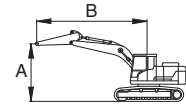



Unit : mm

Model	Boom	Boom	Arm	Counterweight	Shoe	Dozer		Outrigger	
	Type	Length	Length	Weight (kg)	Width	Front	Rear	Front	Rear
HX225S L	Mono	5680	2400	3800	600	-	-	-	-

·  : Rating over-front

·  : Rating over-side or 360 degree



Lift-point height (A)		Lift-point radius (B)										At max. reach		
		1.5 m (4.9 ft)		3.0 m (9.8 ft)		4.5 m (14.8 ft)		6.0 m (19.7 ft)		7.5 m (24.6 ft)		Capacity		Reach
														m (ft)
7.5m 24.6ft	kg lb											*4990 *11000	*4990 *11000	5.79 (19.0)
6.0m 19.7ft	kg lb						*4920 *10850	*4920 *10850				*4580 *10100	*4580 *10100	6.94 (22.8)
4.5m 14.8ft	kg lb				*6420 *14150	*6420 *14150	*5440 *11990	*5440 *11990	*5140 *11330	4490 9900	*4490 *9900	4370 9630	7.62 (25.0)	
3.0m 9.8ft	kg lb				*8270 *18230	*8270 *18230	*6260 *13800	6120 13490	*5420 *11950	4410 9720	*4600 *10140	4030 8880	7.97 (26.1)	
1.5m 4.9ft	kg lb				*9790 *21580	9000 19840	*7070 *15590	5920 13050	5670 12500	4330 9550	*4920 *10850	3940 8690	8.02 (26.3)	
0.0m 0.0ft	kg lb				*10420 *22970	8870 19550	*7580 *16710	5820 12830	5630 12410	4290 9460	5360 11820	4100 9040	7.78 (25.5)	
-1.5m -4.9ft	kg lb			*11830 *26080	*11830 *26080	*10300 *22710	8910 19640	*7620 *16800	5830 12850			5990 13210	4560 10050	7.22 (23.7)
-3.0m -9.8ft	kg lb			*13110 *28900	*13110 *28900	*9380 *20680	9090 20040	*6820 *15040	5980 13180			*6390 *14090	5680 12520	6.25 (20.5)
-4.5m -14.8ft	kg lb													

Unit : mm

Model	Boom	Boom	Arm	Counterweight	Shoe	Dozer		Outrigger	
	Type	Length	Length	Weight (kg)	Width	Front	Rear	Front	Rear
HX225S L	Mono	5680	2920	3800	600	-	-	-	-



: Rating over-front



: Rating over-side or 360 degree

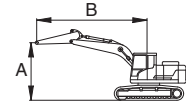

Lift-point height (A)		Lift-point radius (B)										At max. reach		
		1.5 m (4.9 ft)		3.0 m (9.8 ft)		4.5 m (14.8 ft)		6.0 m (19.7 ft)		7.5 m (24.6 ft)		Capacity		Reach
														m (ft)
7.5m	kg							*4360	*4360			*3310	*3310	6.44
24.6ft	lb							*9610	*9610			*7300	*7300	(21.1)
6.0m	kg							*4380	*4380			*3080	*3080	7.49
19.7ft	lb							*9660	*9660			*6790	*6790	(24.6)
4.5m	kg							*4950	*4950	*4680	4500	*3020	*3020	8.13
14.8ft	lb							*10910	*10910	*10320	9920	*6660	*6660	(26.7)
3.0m	kg					*7530	*7530	*5830	*5830	*5070	4400	*3090	*3090	8.46
9.8ft	lb					*16600	*16600	*12850	*12850	*11180	9700	*6810	*6810	(27.7)
1.5m	kg					*9240	9020	*6720	5910	*5530	4290	*3280	*3280	8.50
4.9ft	lb					*20370	19890	*14820	13030	*12190	9460	*7230	*7230	(27.9)
0.0m	kg			*6460	*6460	*10180	8810	*7360	5770	5560	4230	*3650	*3650	8.28
0.0ft	lb			*14240	*14240	*22440	19420	*16230	12720	12260	9330	*8050	*8050	(27.2)
-1.5m	kg	*7100	*7100	*11080	*11080	*10340	8800	*7580	5740	5570	4240	*4320	4060	7.75
-4.9ft	lb	*15650	*15650	*24430	*24430	*22800	19400	*16710	12650	12280	9350	*9520	8950	(25.4)
-3.0m	kg	*11800	*11800	*14050	*14050	*9740	8930	*7170	5830			*5670	4880	6.86
-9.8ft	lb	*26010	*26010	*30970	*30970	*21470	19690	*15810	12850			*12500	10760	(22.5)
-4.5m	kg			*11290	*11290	*7920	*7920					*6170	*6170	5.42
-14.8ft	lb			*24890	*24890	*17460	*17460					*13600	*13600	(17.8)

Unit : mm

Model	Boom	Boom	Arm	Counterweight	Shoe	Dozer		Outrigger	
	Type	Length	Length	Weight (kg)	Width	Front	Rear	Front	Rear
HX225S L	Mono	5680	3900	3800	600	-	-	-	-



: Rating over-front



: Rating over-side or 360 degree

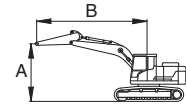

Lift-point height (A)		Lift-point radius (B)												At max. reach		
		1.5 m (4.9 ft)		3.0 m (9.8 ft)		4.5 m (14.8 ft)		6.0 m (19.7 ft)		7.5 m (24.6 ft)		9.0 m (29.5 ft)		Capacity		Reach
																m (ft)
7.5m	kg									*2760	*2760			*2300	*2300	7.64
24.6ft	lb									*6080	*6080			*5070	*5070	(25.1)
6.0m	kg									*3610	*3610			*2160	*2160	8.54
19.7ft	lb									*7960	*7960			*4760	*4760	(28.0)
4.5m	kg						*3980	*3980	*3890	*3890	*2560	*2560	*2120	*2120	9.11	
14.8ft	lb						*8770	*8770	*8580	*8580	*5640	*5640	*4670	*4670	(29.9)	
3.0m	kg			*8880	*8880	*6010	*6010	*4910	*4910	*4380	*4380	*3630	3290	*2150	*2150	9.40
9.8ft	lb			*19580	*19580	*13250	*13250	*10820	*10820	*9660	*9660	*8000	7250	*4740	*4740	(30.8)
1.5m	kg			*7910	*7910	*7970	*7970	*5920	5900	*4940	4240	*4110	3220	*2270	*2270	9.44
4.9ft	lb			*17440	*17440	*17570	*17570	*13050	13010	*10890	9350	*9060	7100	*5000	*5000	(31.0)
0.0m	kg			*7390	*7390	*9390	8720	*6780	5680	*5440	4120	*3760	3180	*2480	*2480	9.23
0.0ft	lb			*16290	*16290	*20700	19220	*14950	12520	*11990	9080	*8290	7010	*5470	*5470	(30.3)
-1.5m	kg	*5820	*5820	*9770	*9770	*10060	8570	*7290	5570	5400	4070			*2840	*2840	8.77
-4.9ft	lb	*12830	*12830	*21540	*21540	*22180	18890	*16070	12280	11900	8970			*6260	*6260	(28.8)
-3.0m	kg	*8970	*8970	*13670	*13670	*10020	8610	*7330	5580	5440	4100			*3500	*3500	7.99
-9.8ft	lb	*19780	*19780	*30140	*30140	*22090	18980	*16160	12300	11990	9040			*7720	*7720	(26.2)
-4.5m	kg	*13000	*13000	*13350	*13350	*9110	8810	*6610	5730					*4940	4860	6.80
-14.8ft	lb	*28660	*28660	*29430	*29430	*20080	19420	*14570	12630					*10890	10710	(22.3)
-6.0m	kg					*6410	*6410									
-19.7ft	lb					*14130	*14130									

6. BUCKET SELECTION GUIDE

1) GENERAL BUCKET

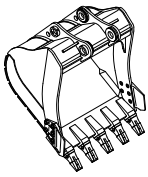
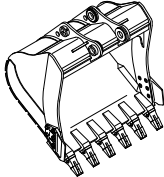
	
★0.52, ※ 0.92, 1.10, 1.20 m ³ SAE heaped bucket	1.34 m ³ SAE heaped bucket

Capacity		Width		Weight	Recommendation				
					5.68 m (18' 8") boom				8.2 m (26' 11") boom
SAE heaped	CECE heaped	Without side cutter	With side cutter		2.0 m arm (6' 7")	2.4 m arm (7' 10")	2.92 m arm (9' 7")	3.90 m arm (12' 10")	6.3 m arm (20' 8")
※0.92 m ³ (1.20 yd ³)	0.80 m ³ (1.05 yd ³)	1150 mm (45.3")	1270 mm (50.0")	770 kg (1700 lb)	●	●	●	■	X
1.10 m ³ (1.44 yd ³)	0.96 m ³ (1.26 yd ³)	1320 mm (52.0")	1440 mm (56.7")	830 kg (1830 lb)	●	◐	■	▲	X
1.20 m ³ (1.57 yd ³)	1.00 m ³ (1.31 yd ³)	1400 mm (55.1")	1520 mm (59.8")	850 kg (1870 lb)	◐	◐	■	X	X
1.34 m ³ (1.75 yd ³)	1.15 m ³ (1.50 yd ³)	1550 mm (61.0")	1670 mm (65.7")	920 kg (2030 lb)	■	■	▲	X	X
★0.52 m ³ (0.68 yd ³)	0.45 m ³ (0.59 yd ³)	935 mm (36.8")	1035 mm (40.7")	460kg (1010 lb)	X	X	X	X	■

※ : Standard bucket

★ : Long reach bucket/Amphibious bucket

●	Applicable for materials with density of 2100 kg/m ³ (3500 lb/yd ³) or less
◐	Applicable for materials with density of 1800 kg/m ³ (3000 lb/yd ³) or less
■	Applicable for materials with density of 1500 kg/m ³ (2500 lb/yd ³) or less
▲	Applicable for materials with density of 1200 kg/m ³ (2000 lb/yd ³) or less
X	Not recommended

※ These recommendations are for general conditions and average use.

Work tools and ground conditions have effects on machine performance.

Select an optimum combination according to the working conditions and the type of work that is being done.

Consult your Hyundai dealer for information on selecting the correct boom–arm–bucket combination.

2) HEAVY DUTY AND ROCK-HEAVY DUTY BUCKET

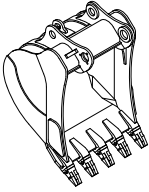
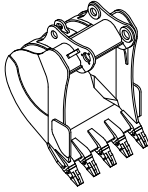
	
◆0.90, 1.05 m ³ SAE heaped bucket	◆0.87, 1.20 m ³ SAE heaped bucket

Capacity		Width		Weight	Recommendation			
SAE heaped	CECE heaped	Without side cutter	With side cutter		5.68 m (18' 8") boom			
					2.0 m arm (6' 7")	2.4 m arm (7' 10")	2.92 m arm (9' 7")	3.90 m arm (12' 10")
◆0.90 m ³ (1.18 yd ³)	0.80 m ³ (1.05 yd ³)	1095 mm (43.1")	-	810 kg (1940 lb)	●	●	●	■
◆1.05 m ³ (1.37 yd ³)	0.92 m ³ (1.20 yd ³)	1290 mm (50.8")	-	890 kg (1960 lb)	●	◐	■	▲
◆0.87 m ³ (1.14 yd ³)	0.75 m ³ (0.98 yd ³)	1140 mm (44.9")	-	900 kg (1980 lb)	●	●	●	■
◆1.00 m ³ (1.31 yd ³)	0.87 m ³ (1.14 yd ³)	1305 mm (51.4")	-	940 kg (2070 lb)	●	●	■	▲
◆1.20 m ³ (1.57 yd ³)	1.00 m ³ (1.31 yd ³)	1410 mm (55.5")	-	1030 kg (2270 lb)	◐	■	▲	X

◆ : Heavy duty bucket ◆ : Rock-Heavy duty bucket

●	Applicable for materials with density of 2100 kg/m ³ (3500 lb/yd ³) or less
◐	Applicable for materials with density of 1800 kg/m ³ (3000 lb/yd ³) or less
■	Applicable for materials with density of 1500 kg/m ³ (2500 lb/yd ³) or less
▲	Applicable for materials with density of 1200 kg/m ³ (2000 lb/yd ³) or less
X	Not recommended

7. UNDERCARRIAGE

1) TRACKS

X-leg type center frame is integrally welded with reinforced box-section track frames. The design includes dry tracks, lubricated rollers, idlers, sprockets, hydraulic track adjusters with shock absorbing springs and assembled track-type tractor shoes with triple grousers.

2) TYPES OF SHOES

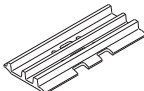
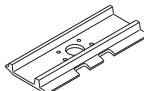
Model	Shapes		Triple grouser				Double grouser	
								
HX225S L	Shoe width	mm (in)	600 (24)	700 (28)	800 (32)	900 (36)	-	-
	Operating weight	kg (lb)	22070 (48660)	22550 (49710)	22830 (50330)	23150 (51040)	-	-
	Ground pressure	kgf/cm ² (psi)	0.47 (6.68)	0.41 (5.58)	0.36 (5.18)	0.33 (4.67)	-	-
	Overall width	mm (ft-in)	2990 (9' 10")	3090 (10' 2")	3190 (10' 6")	3290 (10' 10")	-	-
HX225S L LONG REACH	Shoe width	mm (in)	-	-	800 (32)	-	-	-
	Operating weight	kg (lb)	-	-	24830 (54740)	-	-	-
	Ground pressure	kgf/cm ² (psi)	-	-	0.40 (5.64)	-	-	-
	Overall width	mm (ft-in)	-	-	3190 (10' 6")	-	-	-
HX225S L HIGH WALKER	Shoe width	mm (in)	600 (24)	700 (28)	800 (32)	900 (36)	600 (24)	700 (28)
	Operating weight	kg (lb)	24300 (53570)	24580 (54190)	24860 (54810)	25180 (55510)	24530 (54080)	24850 (54780)
	Ground pressure	kgf/cm ² (psi)	0.52 (7.36)	0.45 (6.38)	0.40 (5.64)	0.36 (5.08)	0.52 (7.42)	0.45 (6.45)
	Overall width	mm (ft-in)	3395 (11' 2")	3495 (11' 6")	3595 (11' 10")	3695 (12' 1")	3395 (11' 2")	3495 (11' 6")

3) NUMBER OF ROLLERS AND SHOES ON EACH SIDE

Item	Quantity
Carrier rollers	2 EA
Track rollers	9 EA
Track shoes	49 EA

4) SELECTION OF TRACK SHOE

Suitable track shoes should be selected according to operating conditions.

Method of selecting shoes

Confirm the category from the list of applications in **table 2**, then use **table 1** to select the shoe. Wide shoes (categories B and C) have limitations on applications. Before using wide shoes, check the precautions, then investigate and study the operating conditions to confirm if these shoes are suitable.

Select the narrowest shoe possible to meet the required flotation and ground pressure. Application of wider shoes than recommendations will cause unexpected problem such as bending of shoes, crack of link, breakage of pin, loosening of shoe bolts and the other various problems.

※ **Table 1**

Track shoe	Specification	Category
600 mm triple grouser	Standard	A
700 mm triple grouser	Option	B
600,700 mm double grouser ★1	Option	B
800 mm triple grouser	Option	C
800 mm triple grouser (long reach)	Standard	C
900 mm triple grouser	Option	C

★1 : HIGH WALKER ONLY

※ **Table 2**

Category	Applications	Precautions
A	Rocky ground, river beds, normal soil	<ul style="list-style-type: none"> Travel at low speed on rough ground with large obstacles such as boulders or fallen trees
B	Normal soil, soft ground	<ul style="list-style-type: none"> These shoes cannot be used on rough ground with large obstacles such as boulders or fallen trees Travel at high speed only on flat ground Travel slowly at low speed if it is impossible to avoid going over obstacles
C	Extremely soft ground (swampy ground)	<ul style="list-style-type: none"> Use the shoes only in the conditions that the machine sinks and it is impossible to use the shoes of category A or B These shoes cannot be used on rough ground with large obstacles such as boulders or fallen trees Travel at high speed only on flat ground Travel slowly at low speed if it is impossible to avoid going over obstacles

8. SPECIFICATIONS FOR MAJOR COMPONENTS

1) ENGINE

Item	Specification
Model	HYUNDAI HM5.9
Type	4-cycle, turbocharged, charge air cooled, mechanical controlled diesel engine
Cooling method	Water cooled
Number of cylinders and arrangement	6 cylinders, in-line
Firing order	1-5-3-6-2-4
Combustion chamber type	Direct injection type
Cylinder bore × stroke	102 × 120 mm (4.02" × 4.72")
Displacement	5900 cc (360 cu in)
Compression ratio	17.3 : 1
Rated net horse power (SAE J1349)	147 Hp at 1950 rpm (110 kW at 1950 rpm)
Rated gross horse power (SAE J1995)	150 Hp at 1950 rpm (112 kW at 1950 rpm)
Max. Maximum torque at 1500 rpm	62.7 kgf · m (453 lbf · ft)
Engine oil quantity	20 ℓ (5.3 U.S. gal)
Wet weight	437 kg (963 lb)
High idling speed	2200 ± 50 rpm
Low idling speed	1050 ± 100 rpm
Min. fuel consumption	155 g/Hp · hr at 1500 rpm
Starting motor	Nippon denso (24 V-4.5 kW)
Alternator	Valeo (24 V-95 A)
Battery	2 × 12 V × 100 Ah

2) MAIN PUMP

Item	Specification
Type	Variable displacement tandem axis piston pumps
Capacity	2 × 130 cc/rev
Maximum pressure	350 kgf/cm ² (4980 psi) [380 kgf/cm ² (5400 psi)]
Rated oil flow	2 × 247 ℓ /min (65.2 U.S. gpm/ 54.3 U.K. gpm)
Rated speed	1900 rpm

[] : Power boost

3) GEAR PUMP

Item	Specification
Type	Fixed displacement gear pump single stage
Capacity	10 cc/rev
Maximum pressure	40 kgf/cm ² (570 psi)
Rated oil flow	19.0 ℓ /min (5.0 U.S. gpm/4.2 U.K. gpm)

4) MAIN CONTROL VALVE

Item	Specification	
	HX225S L	HX225S L Long reach
Type	10 spools two-block	
Operating method	Hydraulic pilot system	
Main relief valve pressure	350 kgf/cm ² (4980 psi) [380 kgf/cm ² (5400 psi)] *1 350 kgf/cm ² (4980 psi) [Not applied power boost]	
Port relief valve pressure	Boom	400 kgf/cm ² (5690 psi)
	Arm	400 kgf/cm ² (5690 psi) 300 kgf/cm ² (4270 psi)
	Bucket	400 kgf/cm ² (5690 psi) 280 kgf/cm ² (3980 psi)

[] : Power boost *1 : Long reach only

5) SWING MOTOR

Item	Specification
Type	Two fixed displacement axial piston motor
Capacity	142.8 cc/rev
Relief pressure	265 kgf/cm ² (3770 psi)
Braking system	Automatic, spring applied hydraulic released
Braking torque	58 kgf/cm ² (420 psi)
Brake release pressure	21.3~35.6 kgf · m (154~257 lbf · ft)
Reduction gear type	2 - stage planetary

6) TRAVEL MOTOR

Item	Specification
Type	Variable displacement axial piston motor
Relief pressure	350 kgf/cm ² (4980 psi)
Reduction gear type	2-stage planetary
Braking system	Automatic, spring applied hydraulic released
Brake release pressure	15.2 kgf/cm ² (216 psi)
Braking torque	65.4 kgf · m (473 lbf · ft)

7) REMOTE CONTROL VALVE

Item		Specification
Type		Pressure reducing type
Operating pressure	Minimum	6.5 kgf/cm ² (92 psi)
	Maximum	25 kgf/cm ² (356 psi)
Single operation stroke	Lever	90 mm (3.5 in)
	Pedal	130 mm (4.4 in)

8) CYLINDER

Item		Specification
Boom cylinder	Bore dia × Rod dia × Stroke	∅ 120 × ∅ 85 × 1290 mm
	Cushion	Extend only
Arm cylinder	Bore dia × Rod dia × Stroke	∅ 140 × ∅ 100 × 1510 mm ★ ∅ 140 × ∅ 100 × 1460 mm
	Cushion	Extend and retract
Bucket cylinder	Bore dia × Rod dia × Stroke	∅ 120 × ∅ 85 × 1055 mm ★ ∅ 100 × ∅ 70 × 870 mm
	Cushion	Extend only

※ Discoloration of cylinder rod can occur when the friction reduction additive of lubrication oil spreads on the rod surface.

※ Discoloration does not cause any harmful effect on the cylinder performance.

★ : LONG REACH

9) SHOE

Item		Width	Ground pressure	Link quantity	Overall width
HX225S L	Standard	600 mm (24")	0.47 kgf/cm ² (6.68 psi)	49	2990 mm (9' 10")
	Option	700 mm (28")	0.41 kgf/cm ² (5.58 psi)	49	3090 mm (10' 2")
		800 mm (32")	0.36 kgf/cm ² (5.18 psi)	49	3190 mm (10' 6")
		900 mm (36")	0.33 kgf/cm ² (4.67 psi)	49	3290 mm (10' 10")
HX225S L LONG REACH	Standard	800 mm (32")	0.40 kgf/cm ² (5.64 psi)	49	3190 mm (10' 6")
HX225S L HIGH WALKER	Standard	600 mm (24")	0.52 kgf/cm ² (7.36 psi)	49	3395 mm (11' 2")
	Option	700 mm (28")	0.45 kgf/cm ² (6.38 psi)	49	3495 mm (11' 6")
		800 mm (32")	0.40 kgf/cm ² (5.64 psi)	49	3595 mm (11' 10")
		900 mm (36")	0.36 kgf/cm ² (5.08 psi)	49	3695 mm (12' 1")
		※ 600 mm (24")	0.52 kgf/cm ² (7.42 psi)	49	3395 mm (11' 2")
		※ 700 mm (28")	0.45 kgf/cm ² (6.45 psi)	49	3495 mm (11' 5")

※ : Double grouser

10) BUCKET

Item	Capacity		Tooth quantity	Width	
	SAE heaped	CECE heaped		Without side cutter	With side cutter
HX225S L	0.92 m ³ (1.20 yd ³)	0.80 m ³ (1.05 yd ³)	5	1150 mm (45.3")	1270 mm (50.0")
	1.10 m ³ (1.44 yd ³)	0.96 m ³ (1.26 yd ³)	5	1320 mm (52.0")	1440 mm (56.7")
	1.20 m ³ (1.57 yd ³)	1.00 m ³ (1.31 yd ³)	5	1400 mm (55.1")	1520 mm (59.8")
	1.34 m ³ (1.75 yd ³)	1.15 m ³ (1.50 yd ³)	6	1550 mm (61.0")	1670 mm (65.7")
	★0.52 m ³ (0.68 yd ³)	0.45 m ³ (0.59 yd ³)	5	935 mm (36.8")	1035 mm (40.7")
	◆0.90 m ³ (1.18 yd ³)	0.80 m ³ (1.05 yd ³)	5	1095 mm (43.1")	–
	◆1.05 m ³ (1.37 yd ³)	0.92 m ³ (1.20 yd ³)	5	1290 mm (50.8")	–
	⊙0.87 m ³ (1.14 yd ³)	0.75 m ³ (0.98 yd ³)	5	1140 mm (44.9")	–
	⊙1.00 m ³ (1.31 yd ³)	0.87 m ³ (1.14 yd ³)	5	1305 mm (51.4")	–
	⊙1.20 m ³ (1.57 yd ³)	1.00 m ³ (1.31 yd ³)	5	1410 mm (55.5")	–

★ : Long reach bucket

◆ : Heavy duty bucket

⊙ : Rock-heavy duty bucket

9. RECOMMENDED OILS

HYUNDAI genuine lubricating oils have been developed to offer the best performance and service life for your equipment. These oils have been tested according to the specifications of HYUNDAI and, therefore, will meet the highest safety and quality requirements.

We recommend that you use only HYUNDAI genuine lubricating oils and grease officially approved by HYUNDAI.

Service point	Kind of fluid	Capacity ℓ (U.S. gal)	Ambient temperature °C (°F)						
			-50 (-58)	-30 (-22)	-20 (-4)	-10 (14)	0 (32)	10 (50)	20 (68)
Engine oil pan	Engine oil	20 (5.3)	★SAE 5W-40						
			SAE 30						
			SAE 10W						
			SAE 10W-30						
			SAE 15W-40						
Swing drive	Gear oil	6.2 (1.6)	★SAE 75W-90						
Final drive		4.5×2 (1.2×2)	SAE 80W-90						
Hydraulic tank	Hydraulic oil	Tank : 160 (42.3) System : 275 (72.6)	★ISO VG 15						
			ISO VG 32						
			ISO VG 46						
			ISO VG 68						
Fuel tank	Diesel fuel	400 (106)	★ASTM D975 NO.1						
			ASTM D975 NO.2						
Fitting (grease nipple)	Grease	As required	★NLGI NO.1						
			NLGI NO.2						
Radiator (reservoir tank)	Mixture of antifreeze and soft water★1	31 (8.2)	Ethylene glycol base permanent type (50 : 50)						
			★Ethylene glycol base permanent type (60 : 40)						

SAE : Society of Automotive Engineers

API : American Petroleum Institute

ISO : International Organization for Standardization

NLGI : National Lubricating Grease Institute

ASTM : American Society of Testing and Material

★ : Cold region

Russia, CIS, Mongolia

★1 : Soft water

City water or distilled water

※ Using any lubricating oils other than HYUNDAI genuine products may lead to a deterioration of performance and cause damage to major components.

※ Do not mix HYUNDAI genuine oil with any other lubricating oil as it may result in damage to the systems of major components.

※ For HYUNDAI genuine lubricating oils and grease for use in regions with extremely low temperatures, please contact HYUNDAI dealers.