

SECTION 1 GENERAL



Group 1 Safety Hints	1-1
Group 2 Specifications	1-10

SECTION 1 GENERAL

GROUP 1 SAFETY

FOLLOW SAFE PROCEDURE

Unsafe work practices are dangerous. Understand service procedure before doing work; Do not attempt shortcuts.

WEAR PROTECTIVE CLOTHING

Wear close fitting clothing and safety equipment appropriate to the job.

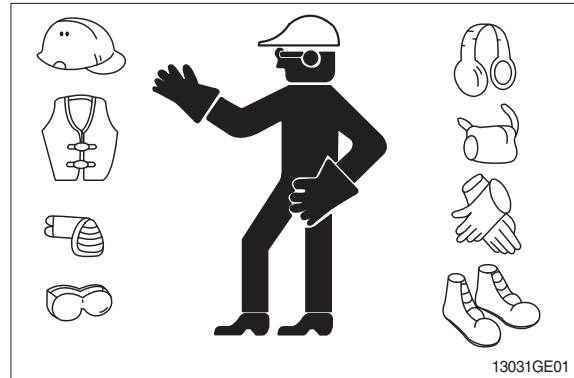

WARN OTHERS OF SERVICE WORK

Unexpected machine movement can cause serious injury. Before performing any work on the excavator, attach a 「Do Not Operate」 tag on the right side control lever.

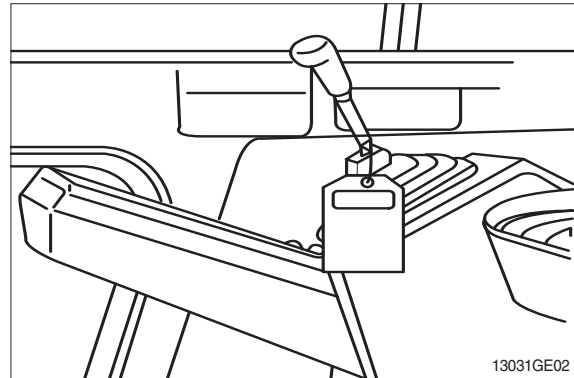

USE HANDHOLDS AND STEPS

Falling is one of the major causes of personal injury. When you get on and off the machine, always maintain a three point contact with the steps and handrails and face the machine. Do not use any controls as handholds. Never jump on or off the machine. Never mount or dismount a moving machine. Be careful of slippery conditions on platforms, steps, and handrails when leaving the machine.

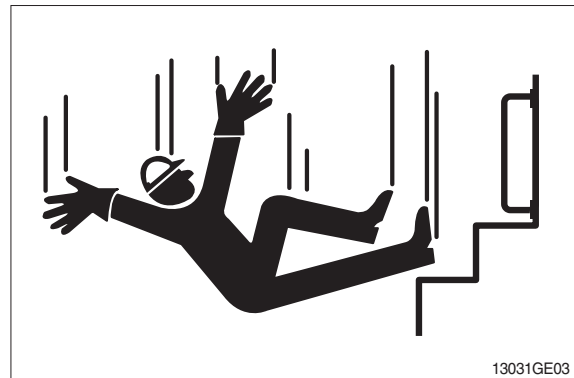

PREPARE FOR EMERGENCIES

Be prepared if a fire starts.

Keep a first aid kit and fire extinguisher handy.

Keep emergency numbers for doctors, ambulance service, hospital, and fire department near your telephone.

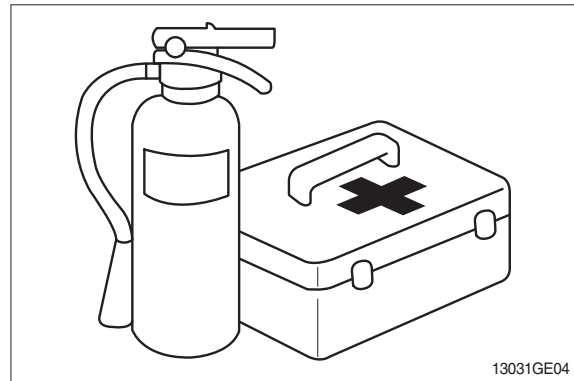

PROTECT AGAINST FLYING DEBRIS

Guard against injury from flying pieces of metal or debris; Wear goggles or safety glasses.

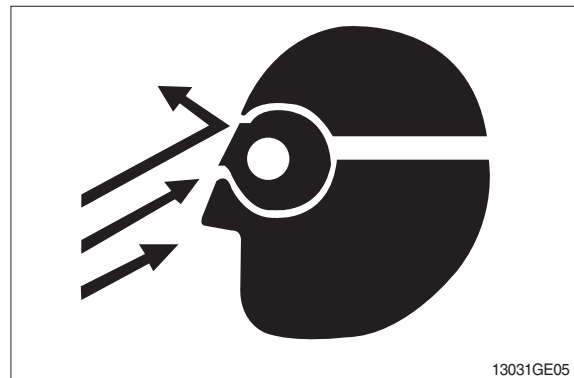

PROTECT AGAINST NOISE

Prolonged exposure to loud noise can cause impairment or loss of hearing.

Wear a suitable hearing protective device such as earmuffs or earplugs to protect against objectionable or uncomfortable loud noises.

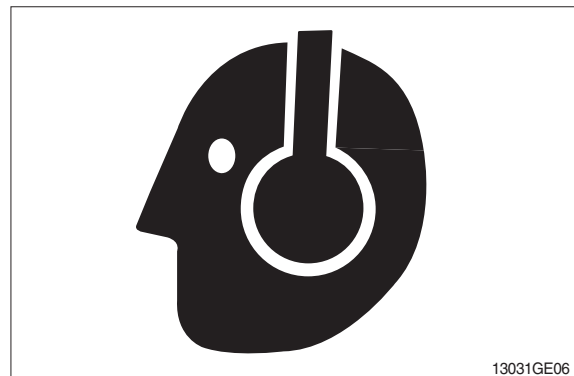

AVOID POWER LINES

Serious injury or death can result from contact with electric lines.

Never move any part of the machine or load closer to electric line than 3m(10ft) plus twice the line insulator length.

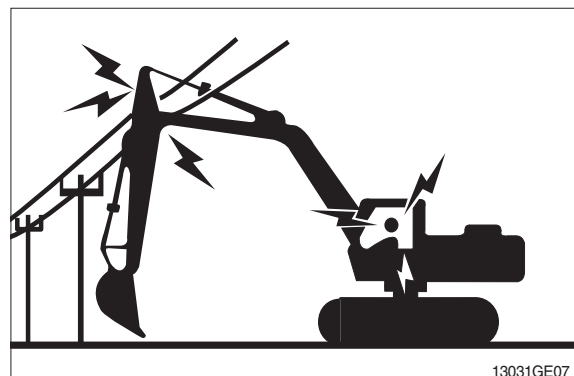

KEEP RIDERS OFF EXCAVATOR

Only allow the operator on the excavator. Keep riders off.

Riders on excavator are subject to injury such as being struck by foreign objects and being thrown off the excavator. Riders also obstruct the operator's view resulting in the excavator being operated in an unsafe manner.

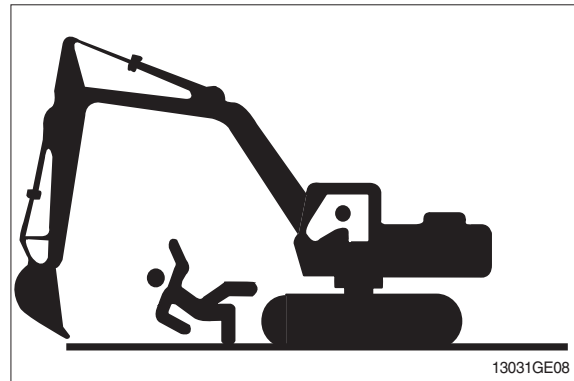

MOVE AND OPERATE MACHINE SAFELY

Bystanders can be run over. Know the location of bystanders before moving, swinging, or operating the machine.

Always keep the travel alarm in working condition. It warns people when the excavator starts to move.

Use a signal person when moving, swinging, or operating the machine in congested areas. Coordinate hand signals before starting the excavator.

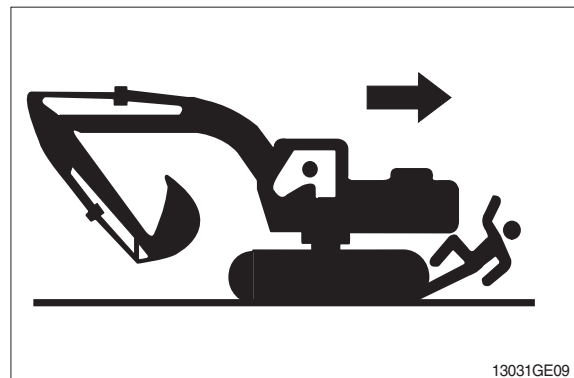

OPERATE ONLY FROM OPERATOR'S SEAT

Avoid possible injury machine damage. Do not start engine by shorting across starter terminals.

NEVER start engine while standing on ground. Start engine only from operator's seat.



PARK MACHINE SAFELY

Before working on the machine:

- Park machine on a level surface.
- Lower bucket to the ground.
- Turn auto idle switch off.
- Run engine at 1/2 speed without load for 2 minutes.
- Turn key switch to OFF to stop engine. Remove key from switch.
- Move pilot control shutoff lever to locked position.
- Allow engine to cool.

SUPPORT MACHINE PROPERLY

Always lower the attachment or implement to the ground before you work on the machine. If you must work on a lifted machine or attachment, securely support the machine or attachment.

Do not support the machine on cinder blocks, hollow tiles, or props that may crumble under continuous load.

Do not work under a machine that is supported solely by a jack. Follow recommended procedures in this manual.

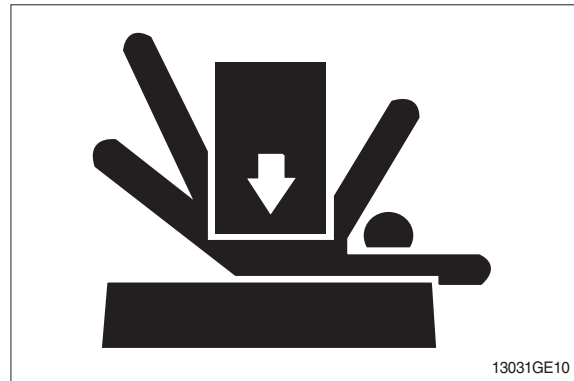

SERVICE COOLING SYSTEM SAFELY

Explosive release of fluids from pressurized cooling system can cause serious burns.

Shut off engine. Only remove filler cap when cool enough to touch with bare hands.



HANDLE FLUIDS SAFELY-AVOID FIRES

Handle fuel with care; It is highly flammable. Do not refuel the machine while smoking or when near open flame or sparks. Always stop engine before refueling machine. Fill fuel tank outdoors.

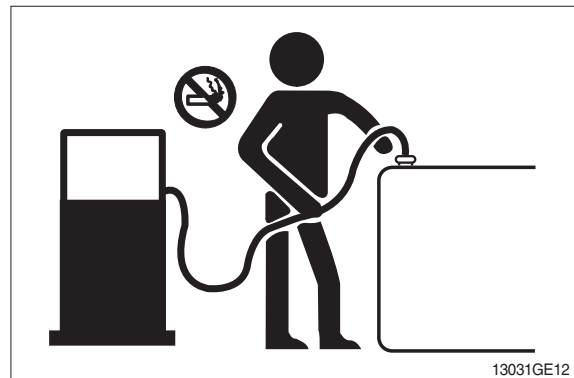

Store flammable fluids away from fire hazards. Do not incinerate or puncture pressurized containers.

Make sure machine is clean of trash, grease, and debris.

Do not store oily rags; They can ignite and burn spontaneously.

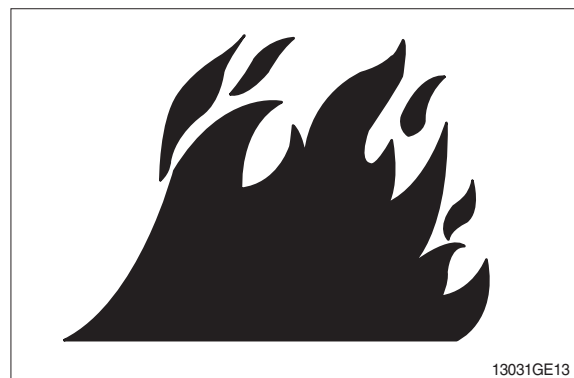

BEWARE OF EXHAUST FUMES

Prevent asphyxiation. Engine exhaust fumes can cause sickness or death.

If you must operate in a building, be positive there is adequate ventilation. Either use an exhaust pipe extension to remove the exhaust fumes or open doors and windows to bring enough outside air into the area.

REMOVE PAINT BEFORE WELDING OR HEATING

Avoid potentially toxic fumes and dust.

Hazardous fumes can be generated when paint is heated by welding, soldering, or using a torch.

Do all work outside or in a well ventilated area. Dispose of paint and solvent properly.

Remove paint before welding or heating:

- If you sand or grind paint, avoid breathing the dust.
Wear an approved respirator.
- If you use solvent or paint stripper, remove stripper with soap and water before welding. Remove solvent or paint stripper containers and other flammable material from area. Allow fumes to disperse at least 15 minutes before welding or heating.

ILLUMINATE WORK AREA SAFELY

Illuminate your work area adequately but safely. Use a portable safety light for working inside or under the machine. Make sure the bulb is enclosed by a wire cage. The hot filament of an accidentally broken bulb can ignite spilled fuel or oil.

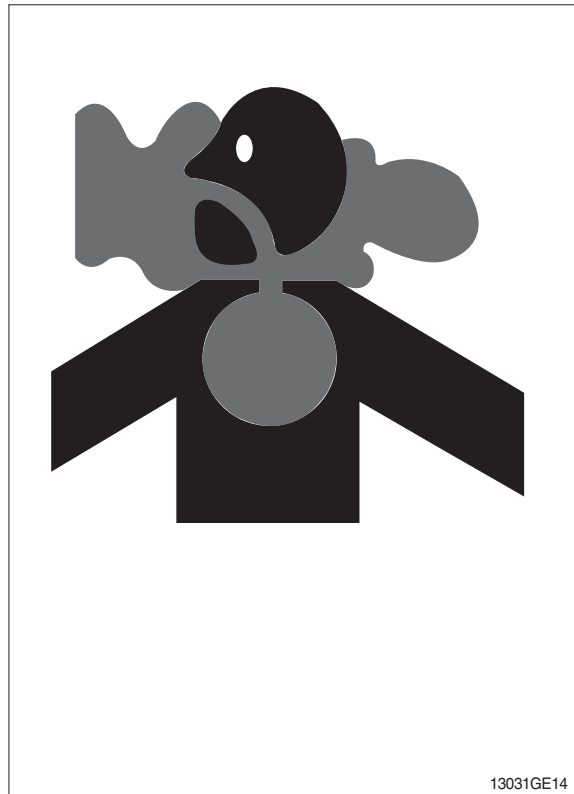

SERVICE MACHINE SAFELY

Tie long hair behind your head. Do not wear a necktie, scarf, loose clothing or necklace when you work near machine tools or moving parts. If these items were to get caught, severe injury could result.

Remove rings and other jewelry to prevent electrical shorts and entanglement in moving parts.

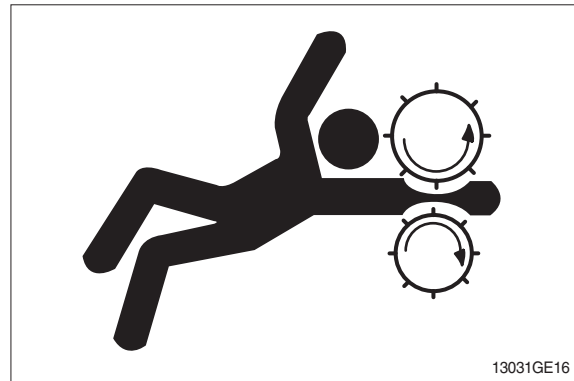

STAY CLEAR OF MOVING PARTS

Entanglements in moving parts can cause serious injury.

To prevent accidents, use care when working around rotating parts.

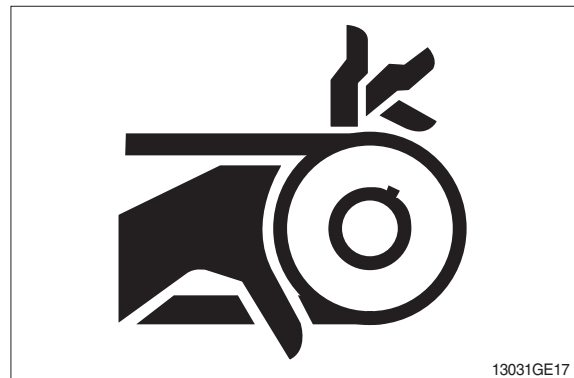

AVOID HIGH PRESSURE FLUIDS

Escaping fluid under pressure can penetrate the skin causing serious injury.

Avoid the hazard by relieving pressure before disconnecting hydraulic or other lines. Tighten all connections before applying pressure.

Search for leaks with a piece of cardboard. Protect hands and body from high pressure fluids.

If an accident occurs, see a doctor immediately. Any fluid injected into the skin must be surgically removed within a few hours or gangrene may result.

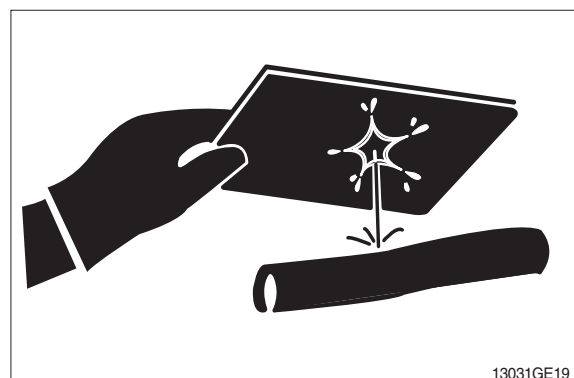

AVOID HEATING NEAR PRESSURIZED FLUID LINES

Flammable spray can be generated by heating near pressurized fluid lines, resulting in severe burns to yourself and bystanders. Do not heat by welding, soldering, or using a torch near pressurized fluid lines or other flammable materials.

Pressurized lines can be accidentally cut when heat goes beyond the immediate flame area. Install fire resisting guards to protect hoses or other materials.



PREVENT BATTERY EXPLOSIONS

Keep sparks, lighted matches, and flame away from the top of battery. Battery gas can explode.

Never check battery charge by placing a metal object across the posts. Use a volt-meter or hydrometer.

Do not charge a frozen battery; It may explode. Warm battery to 16 °C (60 °F).



PREVENT ACID BURNS

Sulfuric acid in battery electrolyte is poisonous. It is strong enough to burn skin, eat holes in clothing, and cause blindness if splashed into eyes.

Avoid the hazard by:

1. Filling batteries in a well-ventilated area.
2. Wearing eye protection and rubber gloves.
3. Avoiding breathing fumes when electrolyte is added.
4. Avoiding spilling or dripping electrolyte.
5. Use proper jump start procedure.

If you spill acid on yourself:

1. Flush your skin with water.
2. Apply baking soda or lime to help neutralize the acid.
3. Flush your eyes with water for 10-15 minutes. Get medical attention immediately.

If acid is swallowed:

1. Drink large amounts of water or milk.
2. Then drink milk of magnesia, beaten eggs, or vegetable oil.
3. Get medical attention immediately.

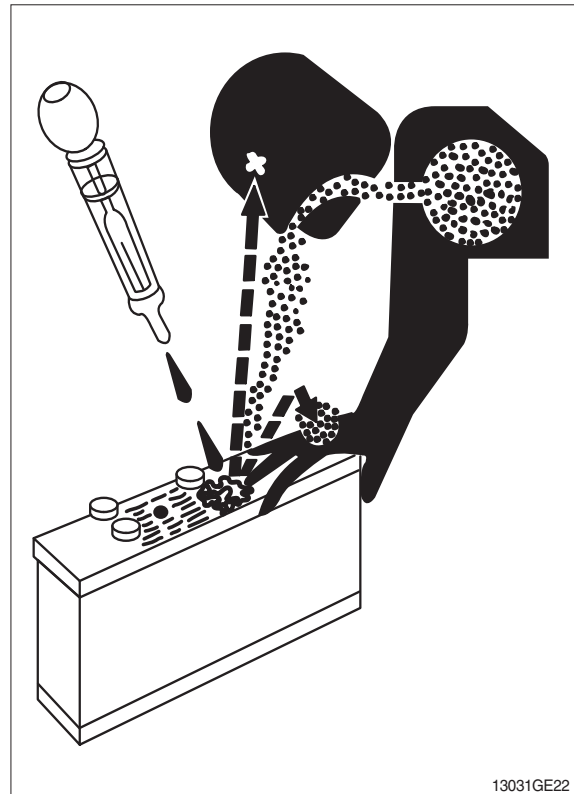

USE TOOLS PROPERLY

Use tools appropriate to the work. Makeshift tools, parts, and procedures can create safety hazards.

Use power tools only to loosen threaded tools and fasteners.

For loosening and tightening hardware, use the correct size tools. **DO NOT** use U.S. measurement tools on metric fasteners. Avoid bodily injury caused by slipping wrenches.

Use only recommended replacement parts. (See Parts catalogue.)

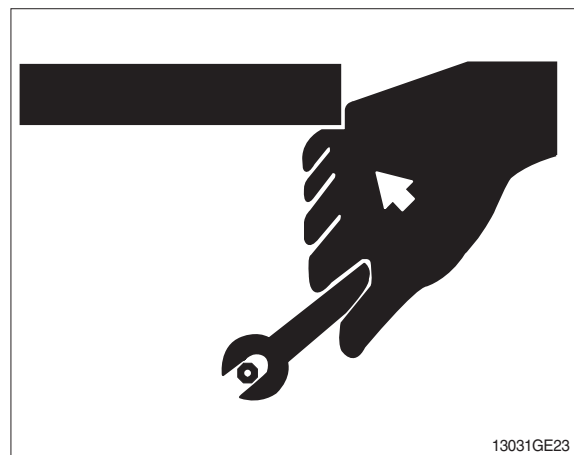

DISPOSE OF FLUIDS PROPERLY

Improperly disposing of fluids can harm the environment and ecology. Before draining any fluids, find out the proper way to dispose of waste from your local environmental agency.

Use proper containers when draining fluids. Do not use food or beverage containers that may mislead someone into drinking from them.

DO NOT pour oil into the ground, down a drain, or into a stream, pond, or lake. Observe relevant environmental protection regulations when disposing of oil, fuel, coolant, brake fluid, filters, batteries, and other harmful waste.

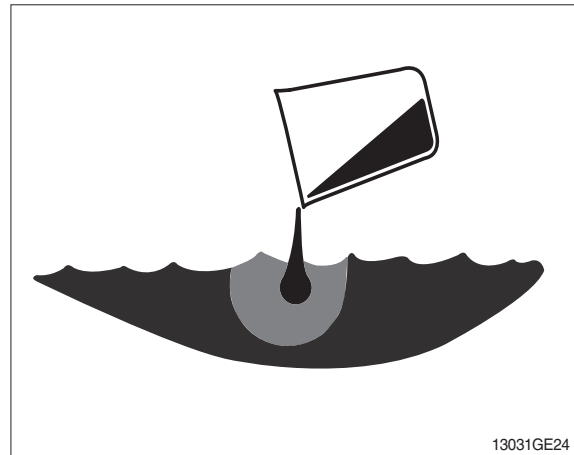

REPLACE SAFETY SIGNS

Replace missing or damaged safety signs. See the machine operator's manual for correct safety sign placement.

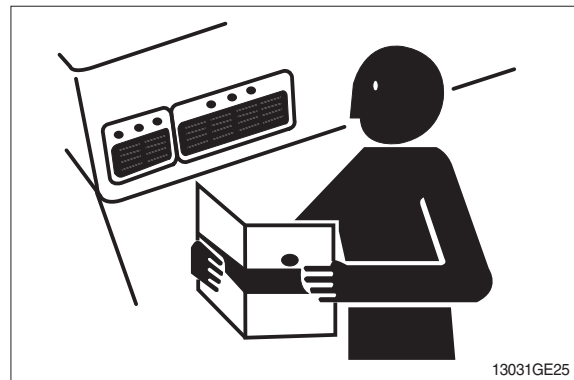

LIVE WITH SAFETY

Before returning machine to customer, make sure machine is functioning properly, especially the safety systems. Install all guards and shields.

GROUP 2 SPECIFICATIONS

1. MAJOR COMPONENT

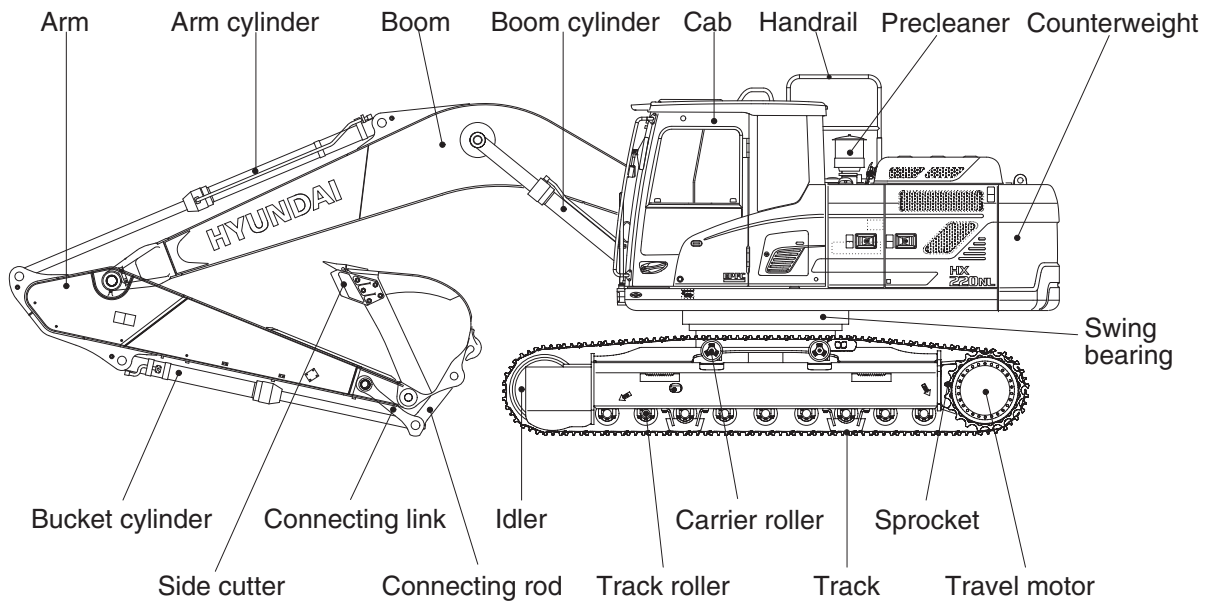
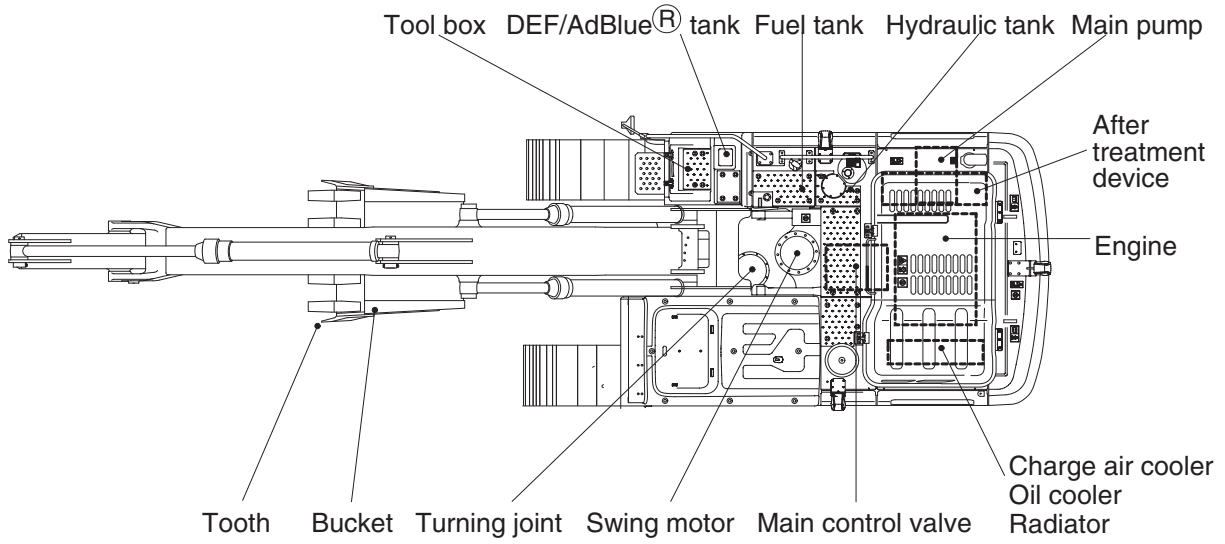

220N2SP01

2. SPECIFICATIONS

1) HX220 NL

(1) 5.65 m (18' 6") boom and 2.92 m (9' 7") arm

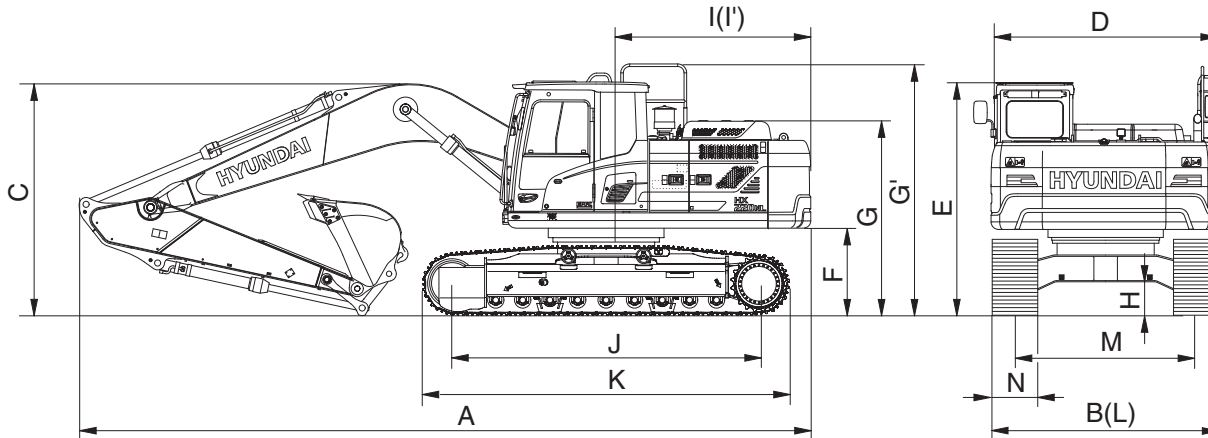

220N2SP02

Description	Unit	Specification
Operating weight	kg (lb)	22300 (49160)
Bucket capacity (SAE heaped), standard	m ³ (yd ³)	0.87 (1.14)
Overall length	A	9510 (31' 2")
Overall width, with 500mm shoe	B	2500 (8' 2")
Overall height of boom	C	3100 (10' 2")
Superstructure width	D	2530 (8' 4")
Overall height of cab	E	3000 (9' 10")
Ground clearance of counterweight	F	1060 (3' 6")
Overall height of engine hood	G	2468 (8' 1")
Overall height of guardrail	G'	3210 (10' 6")
Minimum ground clearance	H	480 (1' 7")
Rear-end distance	I	2770 (9' 1")
Rear-end swing radius	I'	2850 (9' 4")
Distance between tumblers	J	3650 (12' 0")
Undercarriage length	K	4404 (14' 5")
Undercarriage width	L	2500 (8' 2")
Track gauge	M	2000 (6' 7")
Track shoe width, standard	N	500 (20")
Travel speed (low/high)	km/hr (mph)	3.6/5.5 (2.23/3.41) ★3.8/5.8 (2.36/3.60)
Swing speed	rpm	10.8 ★12.5
Gradeability	Degree (%)	35 (70)
Ground pressure (500 mm shoe)	kgf/cm ² (psi)	0.57 (8.11)
Max traction force	kgf (lbf)	20200 (44530)

★ : Machine serial no : #0101-, EPFC

(2) 5.65 m (18' 6") 2-piece boom arm

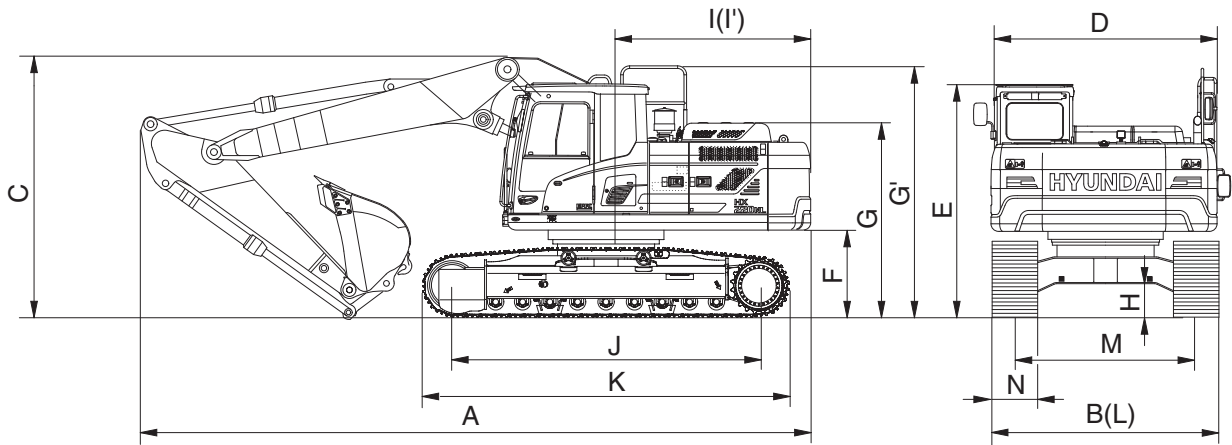

220N2SP03

Description		Unit	Specification
Operating weight		kg (lb)	22300 (49160)
Bucket capacity (SAE heaped), standard		m ³ (yd ³)	0.87 (1.14)
Overall length	A	mm (ft-in)	9520 (31' 2")
Overall width, with 500mm shoe	B		2500 (8' 2")
Overall height of boom	C		3030 (9' 11")
Superstructure width	D		2530 (8' 4")
Overall height of cab	E		3000 (9' 10")
Ground clearance of counterweight	F		1060 (3' 6")
Overall height of engine hood	G		2468 (8' 1")
Overall height of guardrail	G'		3210 (10' 6")
Minimum ground clearance	H		480 (1' 7")
Rear-end distance	I		2770 (9' 1")
Rear-end swing radius	I'		2850 (9' 4")
Distance between tumbler	J		3650 (12' 0")
Undercarriage length	K		4404 (14' 5")
Undercarriage width	L		2500 (8' 2")
Track gauge	M		2000 (6' 7")
Track shoe width, standard	N		500 (20")
Travel speed (low/high)		km/hr (mph)	3.6/5.5 (2.23/3.41) ★3.8/5.8 (2.36/3.60)
Swing speed		rpm	10.8 ★12.5
Gradeability		Degree (%)	35 (70)
Ground pressure (500 mm shoe)		kgf/cm ² (psi)	0.57 (8.11)
Max traction force		kgf (lbf)	20200 (44530)

★ : Machine serial no : #0101-, EPFC

3. WORKING RANGE

1) HX220 NL

(1) 5.68 m (18' 8") mono boom

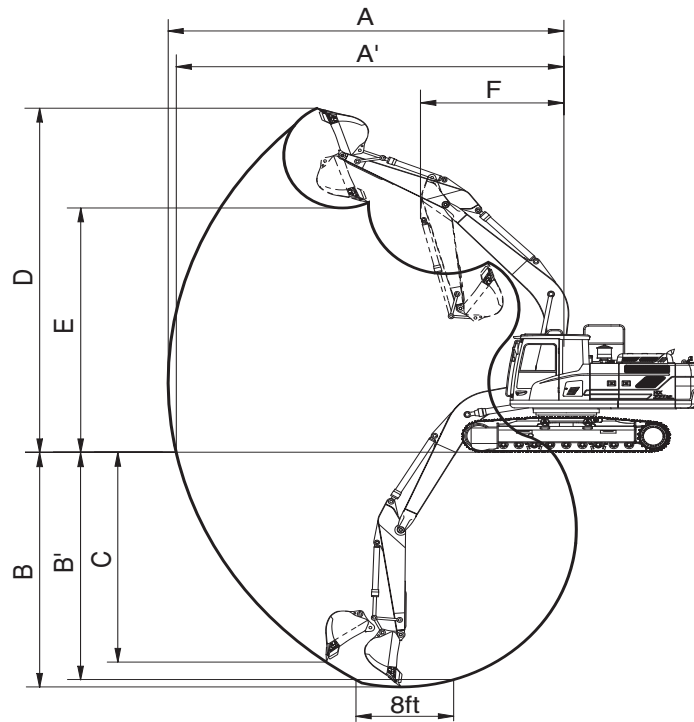

220NF2SP02

Description		2.0 m (6' 7") Arm	2.4 m (7' 10") Arm	2.92 m (9' 7") Arm
Max digging reach	A	9140 mm (30' 0")	9510 mm (31' 2")	9960 mm (32' 8")
Max digging reach on ground	A'	8960 mm (29' 5")	9340 mm (30' 8")	9800 mm (32' 2")
Max digging depth	B	5750 mm (18' 10")	6150 mm (20' 2")	6640 mm (21' 9")
Max digging depth (8 ft level)	B'	5520 mm (18' 1")	5950 mm (19' 6")	6470 mm (21' 3")
Max vertical wall digging depth	C	5320 mm (17' 5")	5780 mm (19' 0")	6250 mm (20' 6")
Max digging height	D	9270 mm (30' 5")	9500 mm (31' 2")	9740 mm (31' 11")
Max dumping height	E	6450 mm (21' 2")	6660 mm (21' 10")	6900 mm (22' 8")
Min swing radius	F	3710 mm (12' 2")	3630 mm (11' 11")	3580 mm (11' 9")
Bucket digging force	SAE	133.4 [144.8] kN	133.4 [144.8] kN	133.4 [144.8] kN
		13600 [14770] kgf	13600 [14770] kgf	13600 [14770] kgf
		29980 [32550] lbf	29980 [32550] lbf	29980 [32550] lbf
	ISO	152.0 [165.0] kN	152.0 [165.0] kN	152.0 [165.0] kN
		15500 [16830] kgf	15500 [16830] kgf	15500 [16830] kgf
		34170 [37100] lbf	34170 [37100] lbf	34170 [37100] lbf
Arm digging force	SAE	144.2 [156.5] kN	102.0 [110.7] kN	119.6 [129.9] kN
		14700 [15960] kgf	10400 [11290] kgf	12200 [13250] kgf
		32410 [35190] lbf	22930 [24900] lbf	26900 [29210] lbf
	ISO	151.0 [164.0] kN	106.9 [116.1] kN	125.5 [136.3] kN
		15400 [16720] kgf	10900 [11830] kgf	12800 [13900] kgf
		33950 [36860] lbf	24030 [26090] lbf	28220 [30640] lbf

[] : Power boost

(2) 5.65 m (18' 6") 2-piece boom

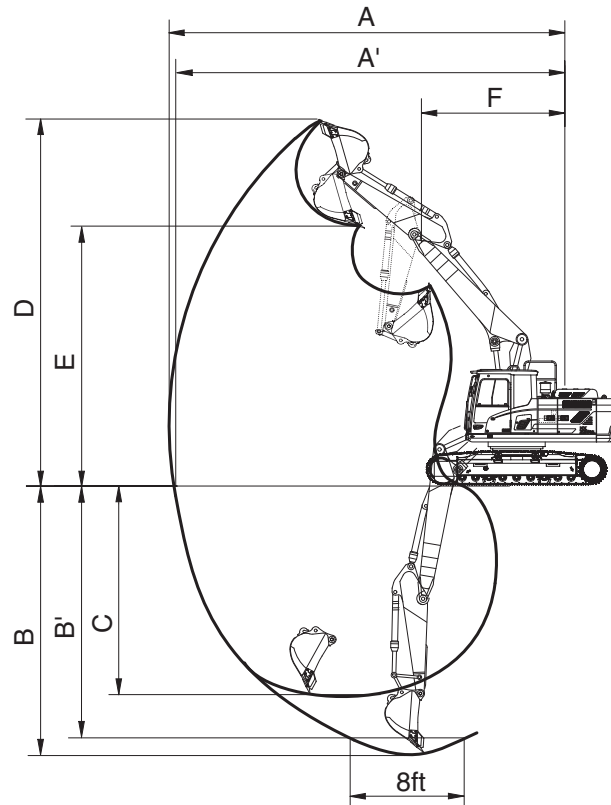

220N2SP53

Description		2.0 m (6' 7") Arm	2.4 m (7' 10") Arm	2.92 m (9' 7") Arm
Max digging reach	A	9120 mm (29' 11")	9530 mm (31' 3")	10020 mm (32' 10")
Max digging reach on ground	A'	8940 mm (29' 4")	9360 mm (30' 9")	9860 mm (32' 4")
Max digging depth	B	5480 mm (18' 0")	5890 mm (19' 4")	6400 mm (21' 0")
Max digging depth (8 ft level)	B'	5360 mm (17' 7")	5770 mm (18' 11")	6300 mm (20' 8")
Max vertical wall digging depth	C	4560 mm (15' 0")	4990 mm (16' 4")	5530 mm (18' 2")
Max digging height	D	10300mm (33' 10")	10670 mm (35' 0")	11080 mm (36' 4")
Max dumping height	E	7390 mm (24' 3")	7740 mm (25' 5")	8160 mm (26' 9")
Min swing radius	F	2870 mm (9' 5")	2670 mm (8' 9")	2540 mm (8' 4")
Bucket digging force	SAE	133.4 [144.8] kN	133.4 [144.8] kN	133.4 [144.8] kN
		13600 [14770] kgf	13600 [14770] kgf	13600 [14770] kgf
		29980 [32550] lbf	29980 [32550] lbf	29980 [32550] lbf
	ISO	152.0 [165.0] kN	152.0 [165.0] kN	152.0 [165.0] kN
		15500 [16830] kgf	15500 [16830] kgf	15500 [16830] kgf
		34170 [37100] lbf	34170 [37100] lbf	34170 [37100] lbf
Arm digging force	SAE	144.2 [156.5] kN	119.6 [129.9] kN	102.0 [110.7] kN
		14700 [15960] kgf	12200 [13250] kgf	10400 [11290] kgf
		32410 [35190] lbf	26900 [29210] lbf	22930 [24900] lbf
	ISO	151.0 [164.0] kN	125.5 [136.3] kN	106.9 [116.1] kN
		15400 [16720] kgf	12800 [13900] kgf	10900 [11830] kgf
		33950 [36860] lbf	28220 [30640] lbf	24030 [26090] lbf

[] : Power boost

4. WEIGHT

1) HX220 NL

Item	HX220 NL	
	kg	lb
Upper structure assembly		
· Main frame weld assembly	1720	3800
· Engine assembly	1485	3270
· Main pump assembly	136 ★140	300 ★310
· Main control valve assembly	220 ★230	490 ★507
· Swing motor assembly	250	550
· Hydraulic oil tank assembly	165	360
· Fuel tank assembly	138	304
· Counterweight	4700	10360
· Cab assembly	500	1100
Lower chassis assembly		
· Track frame weld assembly	2525	5570
· Swing bearing	290	640
· Travel motor assembly	300	660
· Turning joint	57	126
· Track recoil spring	140	310
· Idler	151	333
· Carrier roller	20	45
· Track roller	48	106
· Sprocket	56	123
· Track-chain assembly (500 mm standard triple grouser shoe)	1309	2886
Front attachment assembly		
· 5.65 m boom assembly	1370	3020
· 2.92 m arm assembly	760	1680
· 0.87 m ³ SAE heaped bucket	800	1760
· Boom cylinder assembly	180/1EA	400/1EA
· Arm cylinder assembly	290	640
· Bucket cylinder assembly	175	390
· Bucket control link assembly	170	370

★ : Machine serial no : #0101-, EPFC

※ This information is different with operating and transportation weight because it is not including harness, pipe, oil, fuel so on.

※ Refer to Transportation for actual weight information and Specifications for operating weight.

5. LIFTING CAPACITIES

1) HX220 NL

Unit : mm

Model	Boom	Boom	Arm	Counterweight	Shoe	Dozer		Outrigger	
	Type	Length	Length	Weight (kg)	Width	Front	Rear	Front	Rear
HX220 NL	Mono	5650	2000	4700	500	-	-	-	-



: Rating over-front



: Rating over-side or 360 degree

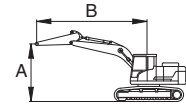

Lift-point height (A)	Lift-point radius (B)								At max. reach			
	3.0 m (9.8 ft)		4.5 m (14.8 ft)		6.0 m (19.7 ft)		7.5 m (24.6 ft)		Capacity		Reach	
											m (ft)	
7.5m 24.6ft	kg									*5730	*5730	4.93
	lb									*12630	*12630	(16.2)
6.0m 19.7ft	kg				*5470	4830				*5550	4450	6.30
	lb				*12060	10650				*12240	9810	(20.7)
4.5m 14.8ft	kg		*6840	*6840	*5810	4710				*5600	3630	7.10
	lb		*15080	*15080	*12810	10380				*12350	8000	(23.3)
3.0m 9.8ft	kg		*8650	6680	*6540	4510	*5740	3270		*5740	3260	7.52
	lb		*19070	14730	*14420	9940	*12650	7210		*12650	7190	(24.7)
1.5m 4.9ft	kg				*7280	4330	6010	3200		5880	3140	7.61
	lb				*16050	9550	13250	7050		12960	6920	(25.0)
0.0m 0.0ft	kg		*10590	6180	*7730	4220				6080	3220	7.40
	lb		*23350	13620	*17040	9300				13400	7100	(24.3)
-1.5m -4.9ft	kg		*10330	6190	*7680	4200				*6520	3560	6.86
	lb		*22770	13650	*16930	9260				*14370	7850	(22.5)
-3.0m -9.8ft	kg	*12630	11780	*9260	6320					*6790	4440	5.89
	lb	*27840	25970	*20410	13930					*14970	9790	(19.3)
-4.5m -14.8ft	kg											
	lb											

※ Note

1. Lifting capacity are based on SAE J1097 and ISO 10567.
2. Lifting capacity of the ROBEX series does not exceed 75% of tipping load with the machine on firm, level ground or 87% of full hydraulic capacity.
3. The lift-point is bucket mounting pin on the arm (without bucket mass).
4. *indicates load limited by hydraulic capacity.

※ Lifting capacities are based upon a standard machine conditions.

Lifting capacities will vary with different work tools, ground conditions and attachments.

The difference between the weight of a work tool attachment must be subtracted.

Consult your Hyundai dealer regarding the lifting capacities for specific work tools and attachments.

▲ Failure to comply to the rated load can cause possible personal injury or property damage.

Make adjustments to the rated load as necessary for non-standard configurations.









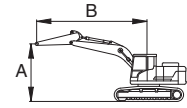

Unit : mm

Model	Boom	Boom	Arm	Counterweight	Shoe	Dozer		Outrigger	
	Type	Length	Length	Weight (kg)	Width	Front	Rear	Front	Rear
HX220 NL	Mono	5650	2400	4700	500	-	-	-	-

·  : Rating over-front

·  : Rating over-side or 360 degree



Lift-point height (A)		Lift-point radius (B)								At max. reach		
		3.0 m (9.8 ft)		4.5 m (14.8 ft)		6.0 m (19.7 ft)		7.5 m (24.6 ft)		Capacity		Reach
												m (ft)
7.5m 24.6ft	kg lb									*4910 *10820	*4910 *10820	5.53 (18.1)
6.0m 19.7ft	kg lb					*5010 *11050	4880 10760			*4430 *9770	3980 8770	6.78 (22.2)
4.5m 14.8ft	kg lb			*6290 *13870	*6290 *13870	*5440 *11990	4740 10450	*4540 *10010	3340 7360	*4300 *9480	3320 7320	7.52 (24.7)
3.0m 9.8ft	kg lb			*8100 *17860	6760 14900	*6230 *13730	4530 9990	*5450 *12020	3270 7210	*4380 *9660	3010 6640	7.92 (26.0)
1.5m 4.9ft	kg lb			*9710 *21410	6340 13980	*7040 *15520	4320 9520	*5810 *12810	3180 7010	*4640 *10230	2900 6390	8.01 (26.3)
0.0m 0.0ft	kg lb			*10460 *23060	6150 13560	*7590 *16730	4190 9240	5930 13070	3120 6880	*5160 *11380	2960 6530	7.81 (25.6)
-1.5m -4.9ft	kg lb	*11090 *24450	*11090 *24450	*10430 *22990	6130 13510	*7700 *16980	4150 9150			*6110 *13470	3240 7140	7.30 (23.9)
-3.0m -9.8ft	kg lb	*13500 *29760	11600 25570	*9620 *21210	6220 13710	*7050 *15540	4220 9300			*6390 *14090	3920 8640	6.39 (21.0)
-4.5m -14.8ft	kg lb			*7280 *16050	6500 14330					*6460 *14240	5850 12900	4.87 (16.0)









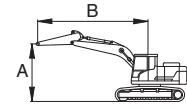



Unit : mm

Model	Boom	Boom	Arm	Counterweight	Shoe	Dozer		Outrigger	
	Type	Length	Length	Weight (kg)	Width	Front	Rear	Front	Rear
HX220 NL	Mono	5650	2920	4700	500	-	-	-	-

·  : Rating over-front

·  : Rating over-side or 360 degree



Lift-point height (A)	Lift-point radius (B)										At max. reach			
	1.5 m (4.9 ft)		3.0 m (9.8 ft)		4.5 m (14.8 ft)		6.0 m (19.7 ft)		7.5 m (24.6 ft)		Capacity		Reach	
													m (ft)	
7.5m 24.6ft	kg							*4190	*4190			*3190	*3190	6.22
	lb							*9240	*9240			*7030	*7030	(20.4)
6.0m 19.7ft	kg							*4440	*4440			*2920	*2920	7.35
	lb							*9790	*9790			*6440	*6440	(24.1)
4.5m 14.8ft	kg							*4940	4780	*4720	3370	*2840	*2840	8.04
	lb							*10890	10540	*10410	7430	*6260	*6260	(26.4)
3.0m 9.8ft	kg				*7350	6870	*5780	4550	*5080	3270	*2880	2720	8.41	
	lb				*16200	15150	*12740	10030	*11200	7210	*6350	6000	(27.6)	
1.5m 4.9ft	kg				*9120	6390	*6680	4320	*5530	3150	*3040	2620	8.49	
	lb				*20110	14090	*14730	9520	*12190	6940	*6700	5780	(27.9)	
0.0m 0.0ft	kg			*6170	*6170	*10180	6120	*7360	4150	5880	3070	*3350	2670	8.31
	lb			*13600	*13600	*22440	13490	*16230	9150	12960	6770	*7390	5890	(27.3)
-1.5m -4.9ft	kg	*6640	*6640	*10610	*10610	*10430	6040	*7640	4080	5840	3040	*3910	2880	7.83
	lb	*14640	*14640	*23390	*23390	*22990	13320	*16840	8990	12870	6700	*8620	6350	(25.7)
-3.0m -9.8ft	kg	*11250	*11250	*14390	11370	*9940	6090	*7320	4110			*5030	3390	6.99
	lb	*24800	*24800	*31720	25070	*21910	13430	*16140	9060			*11090	7470	(22.9)
-4.5m -14.8ft	kg			*11850	11710	*8330	6290					*6180	4650	5.65
	lb			*26120	25820	*18360	13870					*13620	10250	(18.5)









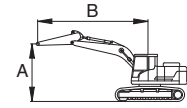

Unit : mm

Model	Boom	Boom	Arm	Counterweight	Shoe	Dozer		Outrigger	
	Type	Length	Length	Weight (kg)	Width	Front	Rear	Front	Rear
HX220 NL	2-piece	5650	2000	4700	500	-	-	-	-

·  : Rating over-front

·  : Rating over-side or 360 degree



Lift-point height (A)		Lift-point radius (B)								At max. reach		
		3.0 m (9.8 ft)		4.5 m (14.8 ft)		6.0 m (19.7 ft)		7.5 m (24.6 ft)		Capacity		Reach
												m (ft)
7.5m	kg			*8100	7640					*7720	6380	5.00
24.6ft	lb			*17860	16840					*17020	14070	(16.4)
6.0m	kg	*9880	*9880	*8150	7570	*6520	4780			*6320	4320	6.35
19.7ft	lb	*21780	*21780	*17970	16690	*14370	10540			*13930	9520	(20.8)
4.5m	kg			*9360	7140	*6780	4650			*5770	3520	7.15
14.8ft	lb			*20640	15740	*14950	10250			*12720	7760	(23.4)
3.0m	kg					*7460	4420	*5650	3190	*5610	3150	7.56
9.8ft	lb					*16450	9740	*12460	7030	*12370	6940	(24.8)
1.5m	kg					*8320	4210	*5870	3110	*5720	3020	7.65
4.9ft	lb					*18340	9280	*12940	6860	*12610	6660	(25.1)
0.0m	kg			*11540	6000	8230	4090			6010	3100	7.45
0.0ft	lb			*25440	13230	18140	9020			13250	6830	(24.4)
-1.5m	kg			*9930	6020	*7630	4080			*6000	3440	6.91
-4.9ft	lb			*21890	13270	*16820	8990			*13230	7580	(22.7)
-3.0m	kg											
-9.8ft	lb											









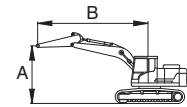

Unit : mm

Model	Boom	Boom	Arm	Counterweight	Shoe	Dozer		Outrigger	
	Type	Length	Length	Weight (kg)	Width	Front	Rear	Front	Rear
HX220 NL	2-piece	5650	2400	4700	500	-	-	-	-

·  : Rating over-front

·  : Rating over-side or 360 degree



Lift-point height (A)		Lift-point radius (B)								At max. reach		
		3.0 m (9.8 ft)		4.5 m (14.8 ft)		6.0 m (19.7 ft)		7.5 m (24.6 ft)		Capacity		Reach
												m (ft)
9.0m	kg									*7640	*7640	3.34
30.0ft	lb									*16840	*16840	(11.0)
7.5m	kg			*7540	*7540					*5630	5370	5.60
24.6ft	lb			*16620	*16620					*12410	11840	(18.4)
6.0m	kg			*7690	7680	*6160	4850			*5040	3860	6.83
19.7ft	lb			*16950	16930	*13580	10690			*11110	8510	(22.4)
4.5m	kg			*8750	7260	*6470	4690	*5260	3270	*4850	3210	7.57
14.8ft	lb			*19290	16010	*14260	10340	*11600	7210	*10690	7080	(24.9)
3.0m	kg			*11210	6660	*7140	4450	*5410	3190	*4880	2900	7.96
9.8ft	lb			*24710	14680	*15740	9810	*11930	7030	*10760	6390	(26.1)
1.5m	kg			*12140	6180	*8020	4210	*5680	3090	*5120	2780	8.06
4.9ft	lb			*26760	13620	*17680	9280	*12520	6810	*11290	6130	(26.4)
0.0m	kg			*11820	5970	8200	4060	5900	3020	*4860	2840	7.86
0.0ft	lb			*26060	13160	18080	8950	13010	6660	*10710	6260	(25.8)
-1.5m	kg	*12040	11150	*10480	5950	*7970	4020			*5310	3120	7.35
-4.9ft	lb	*26540	24580	*23100	13120	*17570	8860			*11710	6880	(24.1)
-3.0m	kg			*8040	6070	*5860	4120					
-9.8ft	lb			*17730	13380	*12920	9080					









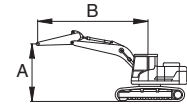

Unit : mm

Model	Boom	Boom	Arm	Counterweight	Shoe	Dozer		Outrigger	
	Type	Length	Length	Weight (kg)	Width	Front	Rear	Front	Rear
HX220 NL	2-piece	5650	2920	4700	500	-	-	-	-

·  : Rating over-front

·  : Rating over-side or 360 degree



Lift-point height (A)		Lift-point radius (B)								At max. reach		
		3.0 m (9.8 ft)		4.5 m (14.8 ft)		6.0 m (19.7 ft)		7.5 m (24.6 ft)		Capacity		Reach
												m (ft)
9.0m	kg									*4570	*4570	4.43
30.0ft	lb									*10080	*10080	(14.5)
7.5m	kg			*6190	*6190	*5240	4910			*3640	*3640	6.30
24.6ft	lb			*13650	*13650	*11550	10820			*8020	*8020	(20.7)
6.0m	kg			*6420	*6420	*5760	4930			*3300	*3300	7.42
19.7ft	lb			*14150	*14150	*12700	10870			*7280	*7280	(24.3)
4.5m	kg	*10360	*10360	*8030	7410	*6080	4750	*4920	3310	*3180	2870	8.10
14.8ft	lb	*22840	*22840	*17700	16340	*13400	10470	*10850	7300	*7010	6330	(26.6)
3.0m	kg			*10070	6800	*6730	4480	*5130	3200	*3200	2610	8.47
9.8ft	lb			*22200	14990	*14840	9880	*11310	7050	*7050	5750	(27.8)
1.5m	kg			*11870	6240	*7610	4220	*5440	3070	*3340	2510	8.55
4.9ft	lb			*26170	13760	*16780	9300	*11990	6770	*7360	5530	(28.1)
0.0m	kg			*11980	5940	8180	4030	*5740	2970	*3640	2560	8.37
0.0ft	lb			*26410	13100	18030	8880	*12650	6550	*8020	5640	(27.5)
-1.5m	kg	*11630	10890	*11030	5860	8080	3950	5830	2940	*4170	2770	7.89
-4.9ft	lb	*25640	24010	*24320	12920	17810	8710	12850	6480	*9190	6110	(25.9)
-3.0m	kg	*11380	11110	*9010	5930	*6750	3990			*4820	3270	7.07
-9.8ft	lb	*25090	24490	*19860	13070	*14880	8800			*10630	7210	(23.2)

6. BUCKET SELECTION GUIDE

1) GENERAL BUCKET

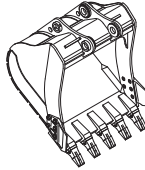
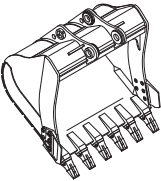
	
0.80, 0.92, 1.10, 1.20 m ³ SAE heaped bucket	1.34 m ³ SAE heaped bucket

Capacity		Width		Weight	Recommendation					
					5.65 m (18' 6") mono boom			5.65 m (18' 6") 2-piece boom		
SAE heaped	CECE heaped	Without side cutter	With side cutter		2.0 m arm (6' 7")	2.4 m arm (7' 10")	2.92 m arm (9' 7")	2.0 m arm (6' 7")	2.4 m arm (7' 10")	2.92 m arm (9' 7")
0.80 m ³ (1.05 yd ³)	0.70 m ³ (0.92 yd ³)	1070 mm (42.1")	1160 mm (45.7")	770 kg (1700 lb)	●	●	●	●	●	◐
0.92 m ³ (1.20 yd ³)	0.80 m ³ (1.05 yd ³)	1190 mm (46.9")	1280 mm (50.4")	820 kg (1810 lb)	●	●	●	●	●	◐
1.10 m ³ (1.44 yd ³)	0.96 m ³ (1.26 yd ³)	1375 mm (54.1")	1465 mm (57.7")	890 kg (1960 lb)	●	◐	◐	●	◐	○
1.20 m ³ (1.57 yd ³)	1.05 m ³ (1.37 yd ³)	1390 mm (54.7")	1480 mm (58.3")	920 kg (2030 lb)	●	◐	○	●	◐	X
1.34 m ³ (1.75 yd ³)	1.17 m ³ (1.53 yd ³)	1525 mm (60.0")	1615 mm (63.6")	990 kg (2180 lb)	◐	○	○	◐	X	X

● Applicable for materials with density of 2000 kgf/m³ (3370 lbf/yd³) or less

◐ Applicable for materials with density of 1600 kgf/m³ (2700 lbf/yd³) or less

○ Applicable for materials with density of 1100 kgf/m³ (1850 lbf/yd³) or less

X Not recommended

※ These recommendations are for general conditions and average use.

Work tools and ground conditions have effects on machine performance.

Select an optimum combination according to the working conditions and the type of work that is being done.

Consult your Hyundai dealer for information on selecting the correct boom–arm–bucket combination.

2) HEAVY DUTY AND ROCK-HEAVY DUTY BUCKET

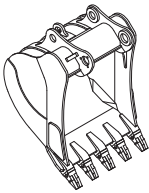
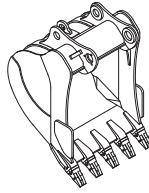
Heavy duty bucket	Rock-Heavy duty bucket
	
<p>◆ 0.90, 1.05 m³ SAE heaped bucket</p>	<p>◆ 0.87, 1.20 m³ SAE heaped bucket</p>

Capacity		Width		Weight	Recommendation					
					5.65 m (18' 6") mono boom			5.65 m (18' 6") 2-piece boom		
SAE heaped	CECE heaped	Without side cutter	With side cutter		2.0 m arm (6' 7")	2.4 m arm (7' 10")	2.92 m arm (9' 7")	2.0 m arm (6' 7")	2.4 m arm (7' 10")	2.92 m arm (9' 7")
◆ 0.90m ³ (1.18 yd ³)	0.79 m ³ (1.03 yd ³)	1210 mm (47.6")	-	880 kg (1940 lb)	●	●	●	●	●	◐
◆ 1.05 m ³ (1.37 yd ³)	0.92 m ³ (1.2 yd ³)	1355 mm (53.3")	-	940 kg (2070 lb)	●	●	◐	●	◐	○
◆ 0.87 m ³ (1.14 yd ³)	0.77 m ³ (1.01 yd ³)	1195 mm (47.0")	-	940 kg (2070 lb)	●	●	●	●	●	◐
◆ 1.20 m ³ (1.57 yd ³)	1.05 m ³ (1.37 yd ³)	1520 mm (59.8")	-	1120 kg (2470 lb)	◐	○	X	◐	○	X

◆ : Heavy duty bucket ◆ : Rock-Heavy duty bucket

●	Applicable for materials with density of 2000 kgf/m ³ (3370 lbf/yd ³) or less
◐	Applicable for materials with density of 1600 kgf/m ³ (2700 lbf/yd ³) or less
○	Applicable for materials with density of 1100 kgf/m ³ (1850 lbf/yd ³) or less
X	Not recommended

7. UNDERCARRIAGE

1) TRACKS

X-leg type center frame is integrally welded with reinforced box-section track frames. The design includes dry tracks, lubricated rollers, idlers, sprockets, hydraulic track adjusters with shock absorbing springs and assembled track-type tractor shoes with triple grousers.

2) TYPES OF SHOES

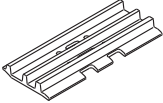
Model	Shapes		Triple grouser		
					
HX220 NL MONO BOOM	Shoe width	mm (in)	500 (20)	600 (24)	700 (28)
	Operating weight	kg (lb)	22300 (49160)	22400 (49380)	22870 (50420)
	Ground pressure	kgf/cm ² (psi)	0.57 (8.11)	0.48 (6.83)	0.42 (5.97)
	Overall width	mm (ft-in)	2500 (8' 2")	2600 (8' 6")	2700 (8'10")
HX220 NL 2-PIECE BOOM	Shoe width	mm (in)	500 (20)	600 (24)	700 (28)
	Operating weight	kg (lb)	23000 (50710)	23100 (50930)	-
	Ground pressure	kgf/cm ² (psi)	0.59 (8.39)	0.49 (6.97)	-
	Overall width	mm (ft-in)	2500 (8' 2")	2600 (8' 6")	2700 (8'10")

3) NUMBER OF ROLLERS AND SHOES ON EACH SIDE

Item	Quantity
Carrier rollers	2 EA
Track rollers	9 EA
Track shoes	49 EA

4) SELECTION OF TRACK SHOE

Suitable track shoes should be selected according to operating conditions.

Method of selecting shoes

Confirm the category from the list of applications in **table 2**, then use **table 1** to select the shoe. Wide shoes (categories B and C) have limitations on applications. Before using wide shoes, check the precautions, then investigate and study the operating conditions to confirm if these shoes are suitable.

Select the narrowest shoe possible to meet the required flotation and ground pressure. Application of wider shoes than recommendations will cause unexpected problem such as bending of shoes, crack of link, breakage of pin, loosening of shoe bolts and the other various problems.

※ **Table 1**

Track shoe	Specification	Category
500 mm triple grouser	Standard	A
600 mm triple grouser	Option	B
700 mm triple grouser	Option	C

※ **Table 2**

Category	Applications	Precautions
A	Rocky ground, river beds, normal soil	<ul style="list-style-type: none"> · Travel at low speed on rough ground with large obstacles such as boulders or fallen trees or a wide range of general civil engineering work
B	Normal soil, soft ground	<ul style="list-style-type: none"> · These shoes cannot be used on rough ground with large obstacles such as boulders or fallen trees · Travel at high speed only on flat ground · Travel slowly at low speed if it is impossible to avoid going over obstacles
C	Extremely soft ground (swampy ground)	<ul style="list-style-type: none"> · Use the shoes only in the conditions that the machine sinks and it is impossible to use the shoes of category A or B · These shoes cannot be used on rough ground with large obstacles such as boulders or fallen trees · Travel at high speed only on flat ground · Travel slowly at low speed if it is impossible to avoid going over obstacles

8. SPECIFICATIONS FOR MAJOR COMPONENTS

1) ENGINE

Item	Specification
Model	Cummins QSB6.7
Type	4-cycle turbocharged, charger air cooled diesel engine
Cooling method	Water cooling
Number of cylinders and arrangement	6 cylinders, in-line
Firing order	1-5-3-6-2-4
Combustion chamber type	Direct injection type
Cylinder bore × stroke	107 × 124 mm (4.2" × 4.9")
Piston displacement	6700 cc (409cu in)
Compression ratio	17.3 : 1
Rated net horse power (SAE J1349)	173 Hp at 1950 rpm (129 kW at 1950 rpm)
Rated gross horse power (SAE J1995)	182.6 Hp at 1950 rpm (136 kW at 1950 rpm)
Maximum torque at 1500 rpm	85.7 kgf · m (620 lbf · ft)
Engine oil quantity	23.7 ℓ (6.26 U.S. gal)
Wet weight	520 kg (1146 lb)
High idling speed	1900 ± 50 rpm
Low idling speed	850 ± 100 rpm
Rated fuel consumption	158 g/Hp · hr at 1950 rpm
Starting motor	Denso (24 V-4.8 kW)
Alternator	Denso (24 V-95 A)
Battery	2 × 12 V × 100 Ah

2) MAIN PUMP

Item	Specification
Type	Variable displacement tandem axis piston pumps
Capacity	2 × 117 cc/rev ★ 2 × 130 cc/rev
Maximum pressure	350 kgf/cm ² (4980 psi) [380 kgf/cm ² (5400 psi)]
Rated oil flow	2 × 228.15 ℓ /min (60.3 U.S. gpm/ 50.2 U.K. gpm) ★ 2 × 241 ℓ /min (63.7 U.S. gpm/ 53.0 U.K. gpm)
Rated speed	1950 rpm ★ 1850 rpm

[] : Power boost

★ : Machine serial no : #0101-, EPFC

3) GEAR PUMP

Item	Specification
Type	Fixed displacement gear pump single stage
Capacity	15 cc/rev ★10 cc/rev
Maximum pressure	40 kgf/cm ² (570 psi) ★45 kgf/cm ² (640 psi)
Rated oil flow	29.3 ℓ /min (7.7 U.S. gpm/6.4 U.K. gpm) ★18.5 ℓ /min (4.9 U.S. gpm/4.1 U.K. gpm)

★ : Machine serial no : #0101-, EPFC

4) MAIN CONTROL VALVE

Item	Specification
Type	9 spools two-block
Operating method	Hydraulic pilot system
Main relief valve pressure	350 kgf/cm ² (4980 psi) [380 kgf/cm ² (5400 psi)]
Overload relief valve pressure	400 kgf/cm ² (5690 psi)

[]: Power boost

5) SWING MOTOR

Item	Specification
Type	Two fixed displacement axial piston motor
Capacity	142.8 cc/rev
Relief pressure	265 kgf/cm ² (3770 psi)
Braking system	Automatic, spring applied hydraulic released
Braking torque	63.3 kgf.m (458 ibf.ft)
Brake release pressure	20.9~35.5 kgf/cm ² (297~505 psi)
Reduction gear type	2 - stage planetary

6) TRAVEL MOTOR

Item	Specification
Type	Variable displacement axial piston motor
Relief pressure	350 kgf/cm ² (4980 psi)
Reduction gear type	2-stage planetary
Braking system	Automatic, spring applied hydraulic released
Brake release pressure	16.1 kgf/cm ² (229 psi)
Braking torque	68.8 kgf · m (498 lbf · ft)

7) REMOTE CONTROL VALVE

Item		Specification
Type		Pressure reducing type
Operating pressure	Minimum	6.5 kgf/cm ² (92 psi)
	Maximum	25 kgf/cm ² (360 psi)
Single operation stroke	Lever(1, 3 port)	90 mm (3.5 in)
	Pedal(2, 4 port)	130 mm (4.4 in)

8) CYLINDER

Item		Specification	
Boom cylinder	Bore dia × Stroke	∅ 120 × 1290 mm	
	Cushion	Extend only	
Arm cylinder	Bore dia × Stroke	∅ 140 × 1510 mm	
	Cushion	Extend and retract	
Bucket cylinder	Bore dia × Stroke	∅ 120 × 1055 mm	
	Cushion	Extend only	
2-piece boom cylinder	1st	Bore dia × Stroke	∅ 120 × 1290 mm
		Cushion	Extend only
	2nd	Bore dia × Stroke	∅ 160 × 1060 mm
		Cushion	-

※ Discoloration of cylinder rod can occur when the friction reduction additive of lubrication oil spreads on the rod surface.

※ Discoloration does not cause any harmful effect on the cylinder performance.

9) SHOE

Item		Width	Ground pressure	Link quantity	Overall width
HX220 NL MONO BOOM	Standard	500 mm (20")	0.57 kgf/cm ² (8.11 psi)	49	2500 mm (8' 2")
	Option	600 mm (24")	0.48 kgf/cm ² (6.83 psi)	49	2600 mm (8' 6")
		700 mm (28")	0.42 kgf/cm ² (5.97 psi)	49	2700 mm (8' 10")
HX220 NL 2-PIECE BOOM	Standard	500 mm (20")	0.59 kgf/cm ² (8.39 psi)	49	2500 mm (8' 2")
	Option	600 mm (24")	0.49 kgf/cm ² (6.97psi)	49	2600 mm (8' 6")
		700 mm (28")		49	2700 mm (8' 10")

10) BUCKET

Item	Capacity		Tooth quantity	Width	
	SAE heaped	CECE heaped		Without side cutter	With side cutter
HX220 NL	0.80 m ³ (1.05 yd ³)	0.70 m ³ (0.92 yd ³)	5	1070 mm (42.1")	1160 mm (45.7")
	0.87 m ³ (1.14 yd ³)	0.76 m ³ (0.99 yd ³)	5	1140 mm (44.9")	1230 mm (48.4")
	0.92 m ³ (1.20 yd ³)	0.80 m ³ (1.05 yd ³)	5	1190 mm (46.9")	1280 mm (50.4")
	1.10 m ³ (1.44 yd ³)	0.96 m ³ (1.26 yd ³)	5	1375 mm (54.1")	1465 mm (57.7")
	1.20 m ³ (1.57 yd ³)	1.05 m ³ (1.37 yd ³)	5	1390 mm (54.7")	1480 mm (58.3")
	1.34 m ³ (1.75 yd ³)	1.17 m ³ (1.53 yd ³)	6	1525 mm (60.0")	1615 mm (63.6")
	◆ 0.90 m ³ (1.18 yd ³)	0.79 m ³ (1.03 yd ³)	5	1210 mm (47.6")	–
	◆ 1.05 m ³ (1.37 yd ³)	0.92 m ³ (1.20 yd ³)	5	1355 mm (53.3")	–
	◆ 0.87 m ³ (1.14 yd ³)	0.77 m ³ (1.01 yd ³)	5	1195 mm (47.0")	–
	◆ 1.20 m ³ (1.57 yd ³)	1.05 m ³ (1.37 yd ³)	5	1520 mm (59.8")	–

◆ : Heavy duty bucket

◆ : Rock-heavy duty bucket

9. RECOMMENDED OILS

HYUNDAI genuine lubricating oils have been developed to offer the best performance and service life for your equipment. These oils have been tested according to the specifications of HYUNDAI and, therefore, will meet the highest safety and quality requirements.

We recommend that you use only HYUNDAI genuine lubricating oils and grease officially approved by HYUNDAI.

Service point	Kind of fluid	Capacity ℓ (U.S. gal)	Ambient temperature °C (°F)							
			-50 (-58)	-30 (-22)	-20 (-4)	-10 (14)	0 (32)	10 (50)	20 (68)	30 (86)
Engine oil pan	Engine oil	23.7 (6.3)	★SAE 5W-40				SAE 30			
			SAE 10W				SAE 10W-30			
			SAE 15W-40							
DEF/ AdBlue® tank	Mixture of urea and deionized water	27 (7.1)	ISO 22241, High-purity urea + deionized water (32.5:67.5)							
Swing drive	Gear oil	6.2 (1.2)	★SAE 75W-90							
Final drive		4.5×2 (1.2×2)	SAE 80W-90							
Hydraulic tank	Hydraulic oil	Tank : 165 (43.6) System : 340 (89.8)	★ISO VG 15				ISO VG 32			
			ISO VG 46, HBHO VG 46★ ³				ISO VG 68			
Fuel tank	Diesel fuel★ ¹	310 (81.9)	★ASTM D975 NO.1				ASTM D975 NO.2			
Fitting (grease nipple)	Grease	As required	★NLGI NO.1				NLGI NO.2			
Radiator (reservoir tank)	Mixture of antifreeze and soft water★ ²	40 (10.6)	Ethylene glycol base permanent type (50 : 50)							
			★Ethylene glycol base permanent type (60 : 40)							

SAE : Society of Automotive Engineers

API : American Petroleum Institute

ISO : International Organization for Standardization

NLGI : National Lubricating Grease Institute

ASTM : American Society of Testing and Material

DEF : Diesel Exhaust Fluid, DEF compatible with AdBlue®

★ : Cold region (Russia, CIS, Mongolia)

★¹ : Ultra low sulfur diesel
- sulfur content ≤ 15 ppm

★² : Soft water
City water or distilled water

★³ : Hyundai Bio Hydraulic Oil

※ Using any lubricating oils other than HYUNDAI genuine products may lead to a deterioration of performance and cause damage to major components.

※ Do not mix HYUNDAI genuine oil with any other lubricating oil as it may result in damage to the systems of major components.

※ Do not use any engine oil other than that specified above, as it may clog the diesel particulate filter(DPF).

※ For HYUNDAI genuine lubricating oils and grease for use in regions with extremely low temperatures, please contact HYUNDAI dealers.