

SECTION 1 GENERAL

Group 1 Safety Hints	1-1
Group 2 Specifications	1-10

SECTION 1 GENERAL

GROUP 1 SAFETY

FOLLOW SAFE PROCEDURE

Unsafe work practices are dangerous. Understand service procedure before doing work; Do not attempt shortcuts.

WEAR PROTECTIVE CLOTHING

Wear close fitting clothing and safety equipment appropriate to the job.

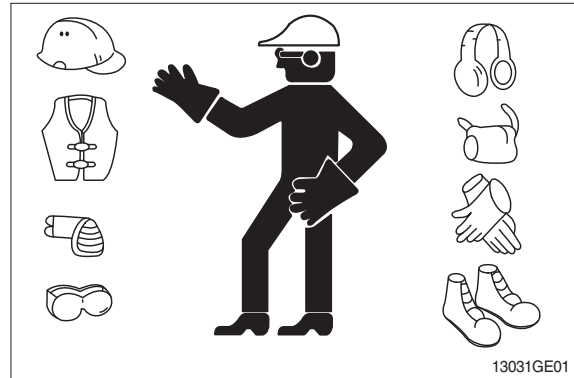

WARN OTHERS OF SERVICE WORK

Unexpected machine movement can cause serious injury. Before performing any work on the excavator, attach a 「Do Not Operate」 tag on the right side control lever.

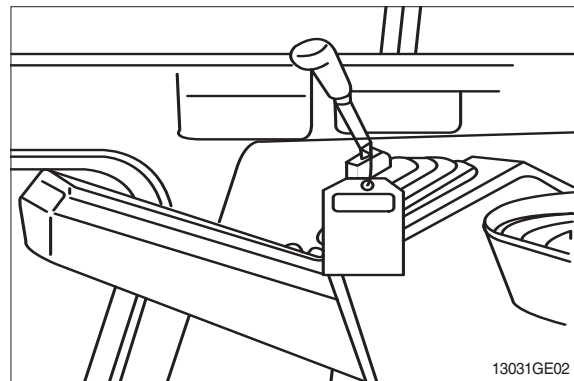

USE HANDHOLDS AND STEPS

Falling is one of the major causes of personal injury. When you get on and off the machine, always maintain a three point contact with the steps and handrails and face the machine. Do not use any controls as handholds. Never jump on or off the machine. Never mount or dismount a moving machine. Be careful of slippery conditions on platforms, steps, and handrails when leaving the machine.

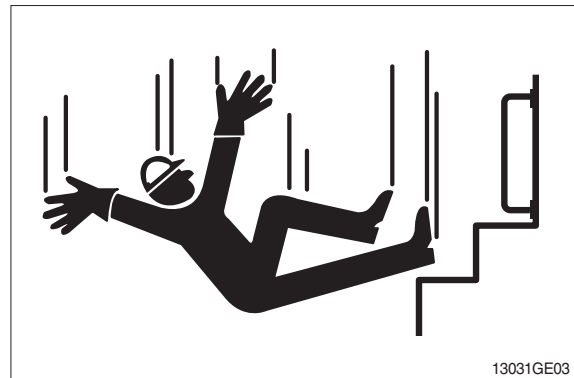

PREPARE FOR EMERGENCIES

Be prepared if a fire starts.

Keep a first aid kit and fire extinguisher handy.

Keep emergency numbers for doctors, ambulance service, hospital, and fire department near your telephone.

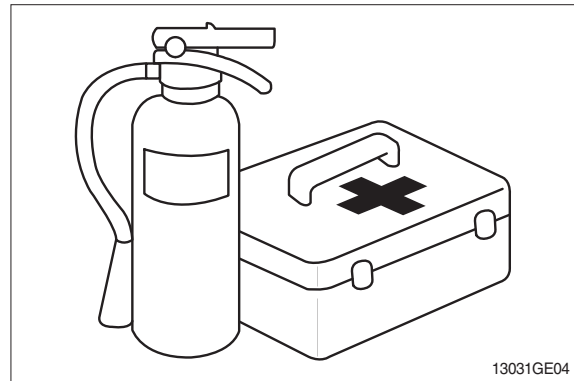

PROTECT AGAINST FLYING DEBRIS

Guard against injury from flying pieces of metal or debris; Wear goggles or safety glasses.

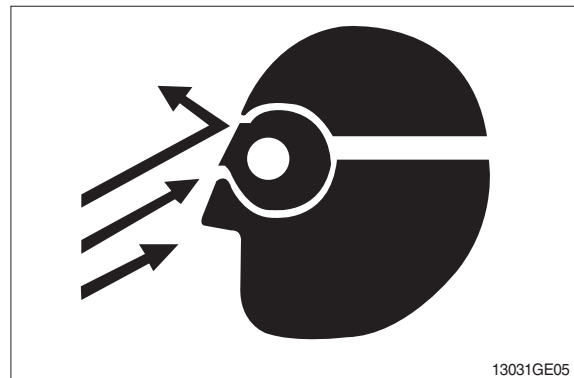

PROTECT AGAINST NOISE

Prolonged exposure to loud noise can cause impairment or loss of hearing.

Wear a suitable hearing protective device such as earmuffs or earplugs to protect against objectionable or uncomfortable loud noises.



AVOID POWER LINES

Serious injury or death can result from contact with electric lines.

Never move any part of the machine or load closer to electric line than 3m(10ft) plus twice the line insulator length.

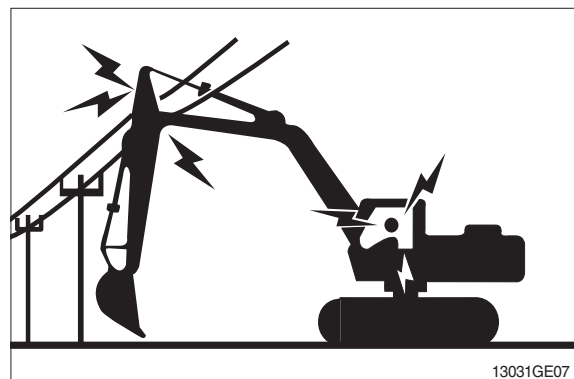

KEEP RIDERS OFF EXCAVATOR

Only allow the operator on the excavator. Keep riders off.

Riders on excavator are subject to injury such as being struck by foreign objects and being thrown off the excavator. Riders also obstruct the operator's view resulting in the excavator being operated in an unsafe manner.

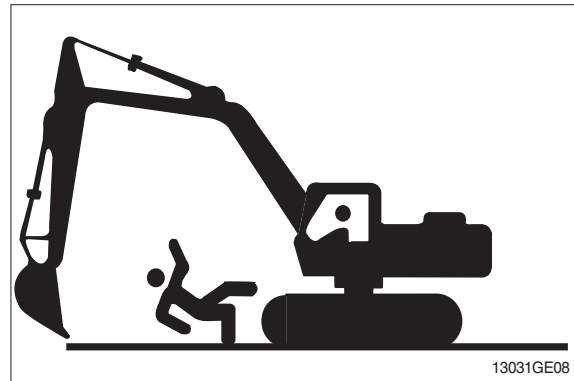

MOVE AND OPERATE MACHINE SAFELY

Bystanders can be run over. Know the location of bystanders before moving, swinging, or operating the machine.

Always keep the travel alarm in working condition. It warns people when the excavator starts to move.

Use a signal person when moving, swinging, or operating the machine in congested areas. Coordinate hand signals before starting the excavator.

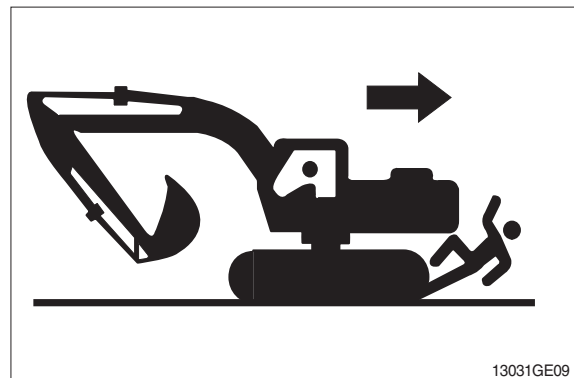

OPERATE ONLY FROM OPERATOR'S SEAT

Avoid possible injury machine damage. Do not start engine by shorting across starter terminals.

NEVER start engine while standing on ground. Start engine only from operator's seat.



PARK MACHINE SAFELY

Before working on the machine:

- Park machine on a level surface.
- Lower bucket to the ground.
- Turn auto idle switch off.
- Run engine at 1/2 speed without load for 2 minutes.
- Turn key switch to OFF to stop engine. Remove key from switch.
- Move pilot control shutoff lever to locked position.
- Allow engine to cool.

SUPPORT MACHINE PROPERLY

Always lower the attachment or implement to the ground before you work on the machine. If you must work on a lifted machine or attachment, securely support the machine or attachment.

Do not support the machine on cinder blocks, hollow tiles, or props that may crumble under continuous load.

Do not work under a machine that is supported solely by a jack. Follow recommended procedures in this manual.

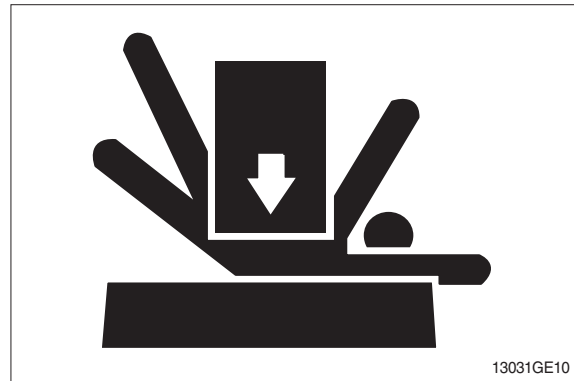

SERVICE COOLING SYSTEM SAFELY

Explosive release of fluids from pressurized cooling system can cause serious burns.

Shut off engine. Only remove filler cap when cool enough to touch with bare hands.



HANDLE FLUIDS SAFELY-AVOID FIRES

Handle fuel with care; It is highly flammable. Do not refuel the machine while smoking or when near open flame or sparks. Always stop engine before refueling machine. Fill fuel tank outdoors.

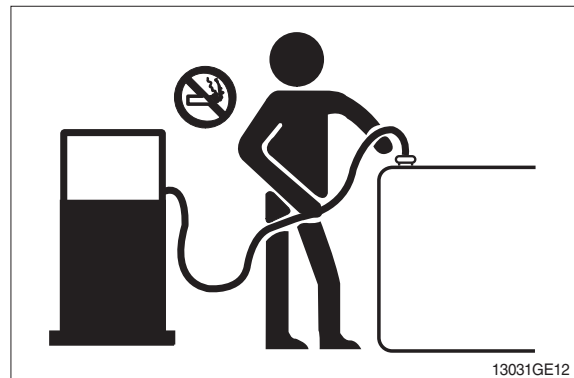

Store flammable fluids away from fire hazards. Do not incinerate or puncture pressurized containers.

Make sure machine is clean of trash, grease, and debris.

Do not store oily rags; They can ignite and burn spontaneously.



BEWARE OF EXHAUST FUMES

Prevent asphyxiation. Engine exhaust fumes can cause sickness or death.

If you must operate in a building, be positive there is adequate ventilation. Either use an exhaust pipe extension to remove the exhaust fumes or open doors and windows to bring enough outside air into the area.

REMOVE PAINT BEFORE WELDING OR HEATING

Avoid potentially toxic fumes and dust.

Hazardous fumes can be generated when paint is heated by welding, soldering, or using a torch.

Do all work outside or in a well ventilated area. Dispose of paint and solvent properly.

Remove paint before welding or heating:

- If you sand or grind paint, avoid breathing the dust.
Wear an approved respirator.
- If you use solvent or paint stripper, remove stripper with soap and water before welding. Remove solvent or paint stripper containers and other flammable material from area. Allow fumes to disperse at least 15 minutes before welding or heating.

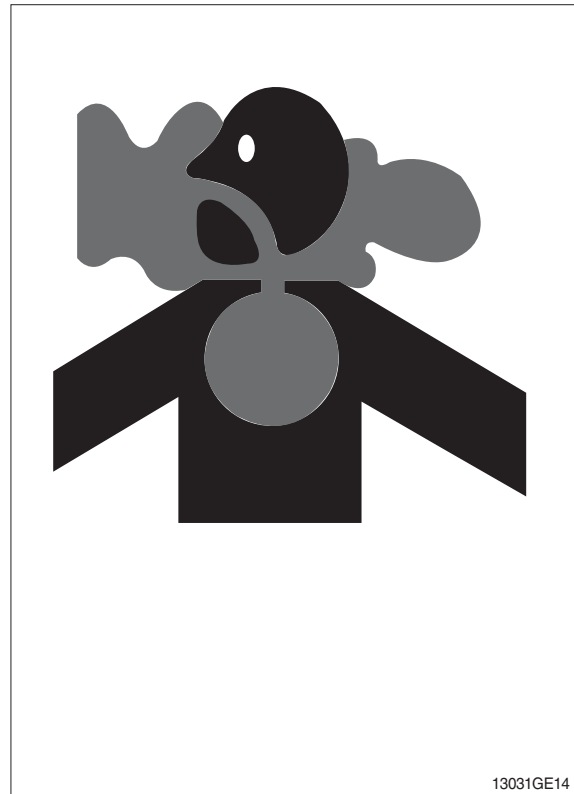

ILLUMINATE WORK AREA SAFELY

Illuminate your work area adequately but safely. Use a portable safety light for working inside or under the machine. Make sure the bulb is enclosed by a wire cage. The hot filament of an accidentally broken bulb can ignite spilled fuel or oil.



SERVICE MACHINE SAFELY

Tie long hair behind your head. Do not wear a necktie, scarf, loose clothing or necklace when you work near machine tools or moving parts. If these items were to get caught, severe injury could result.

Remove rings and other jewelry to prevent electrical shorts and entanglement in moving parts.

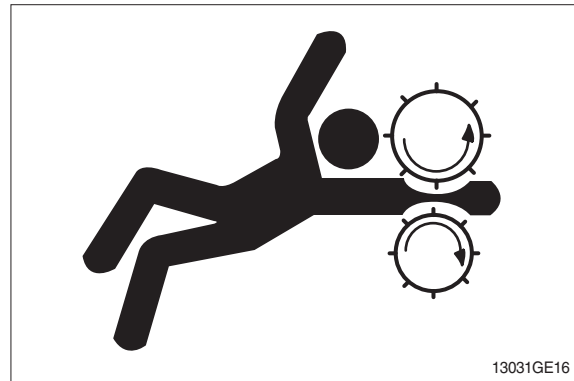

STAY CLEAR OF MOVING PARTS

Entanglements in moving parts can cause serious injury.

To prevent accidents, use care when working around rotating parts.

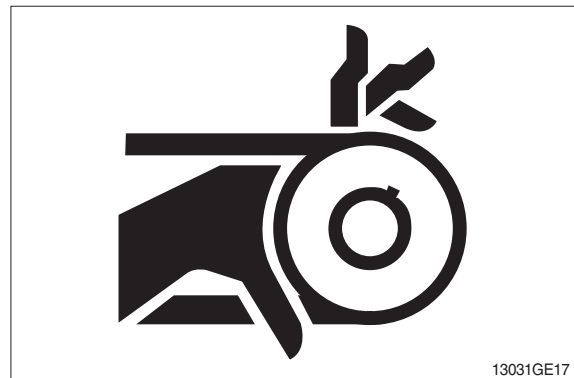

AVOID HIGH PRESSURE FLUIDS

Escaping fluid under pressure can penetrate the skin causing serious injury.

Avoid the hazard by relieving pressure before disconnecting hydraulic or other lines. Tighten all connections before applying pressure.

Search for leaks with a piece of cardboard. Protect hands and body from high pressure fluids.

If an accident occurs, see a doctor immediately. Any fluid injected into the skin must be surgically removed within a few hours or gangrene may result.

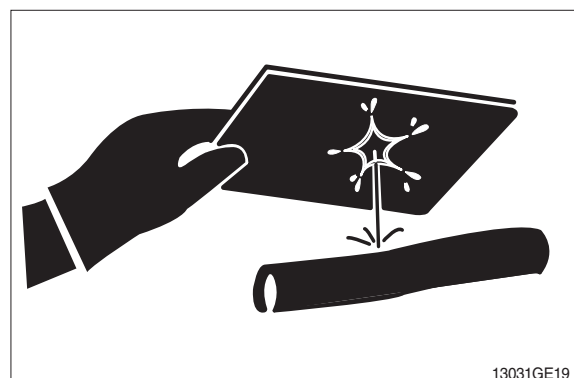

AVOID HEATING NEAR PRESSURIZED FLUID LINES

Flammable spray can be generated by heating near pressurized fluid lines, resulting in severe burns to yourself and bystanders. Do not heat by welding, soldering, or using a torch near pressurized fluid lines or other flammable materials.

Pressurized lines can be accidentally cut when heat goes beyond the immediate flame area. Install fire resisting guards to protect hoses or other materials.



PREVENT BATTERY EXPLOSIONS

Keep sparks, lighted matches, and flame away from the top of battery. Battery gas can explode.

Never check battery charge by placing a metal object across the posts. Use a volt-meter or hydrometer.

Do not charge a frozen battery; It may explode. Warm battery to 16° C (60° F).



PREVENT ACID BURNS

Sulfuric acid in battery electrolyte is poisonous. It is strong enough to burn skin, eat holes in clothing, and cause blindness if splashed into eyes.

Avoid the hazard by:

1. Filling batteries in a well-ventilated area.
2. Wearing eye protection and rubber gloves.
3. Avoiding breathing fumes when electrolyte is added.
4. Avoiding spilling or dripping electrolyte.
5. Use proper jump start procedure.

If you spill acid on yourself:

1. Flush your skin with water.
2. Apply baking soda or lime to help neutralize the acid.
3. Flush your eyes with water for 10-15 minutes. Get medical attention immediately.

If acid is swallowed:

1. Drink large amounts of water or milk.
2. Then drink milk of magnesia, beaten eggs, or vegetable oil.
3. Get medical attention immediately.

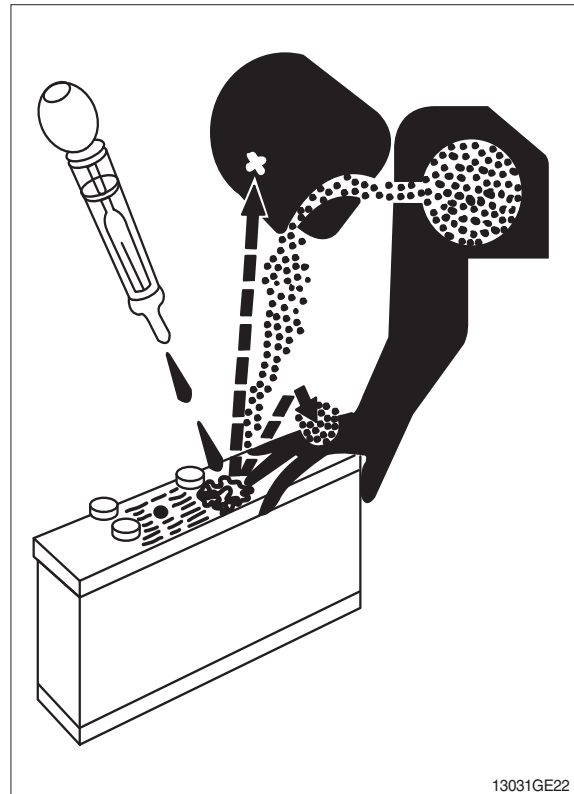

USE TOOLS PROPERLY

Use tools appropriate to the work. Makeshift tools, parts, and procedures can create safety hazards.

Use power tools only to loosen threaded tools and fasteners.

For loosening and tightening hardware, use the correct size tools. **DO NOT** use U.S. measurement tools on metric fasteners. Avoid bodily injury caused by slipping wrenches.

Use only recommended replacement parts. (See Parts catalogue.)

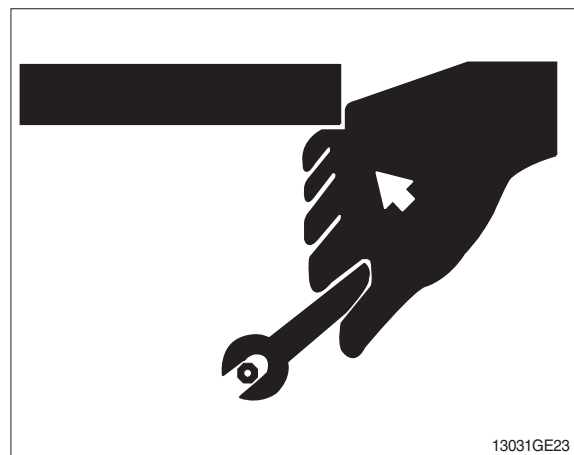

DISPOSE OF FLUIDS PROPERLY

Improperly disposing of fluids can harm the environment and ecology. Before draining any fluids, find out the proper way to dispose of waste from your local environmental agency.

Use proper containers when draining fluids. Do not use food or beverage containers that may mislead someone into drinking from them.

DO NOT pour oil into the ground, down a drain, or into a stream, pond, or lake. Observe relevant environmental protection regulations when disposing of oil, fuel, coolant, brake fluid, filters, batteries, and other harmful waste.

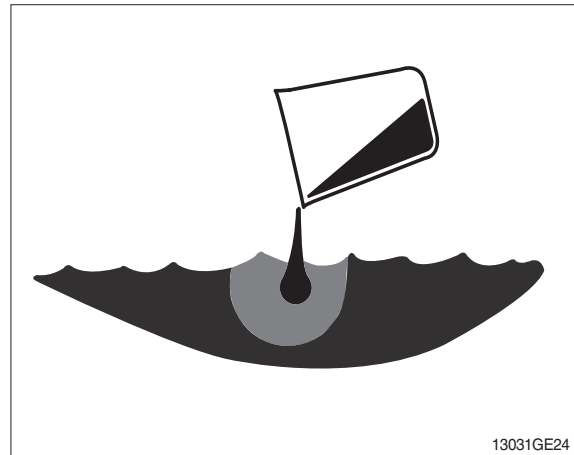

REPLACE SAFETY SIGNS

Replace missing or damaged safety signs. See the machine operator's manual for correct safety sign placement.

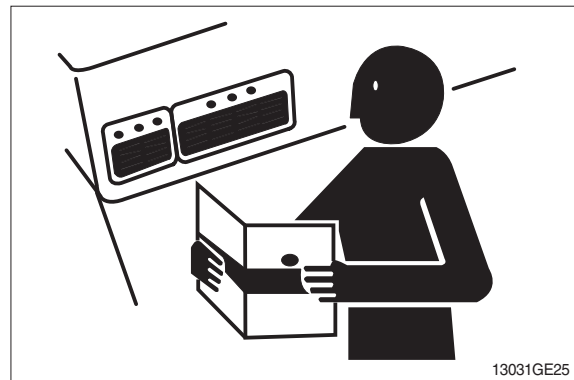

LIVE WITH SAFETY

Before returning machine to customer, make sure machine is functioning properly, especially the safety systems. Install all guards and shields.

GROUP 2 SPECIFICATIONS

1. MAJOR COMPONENT

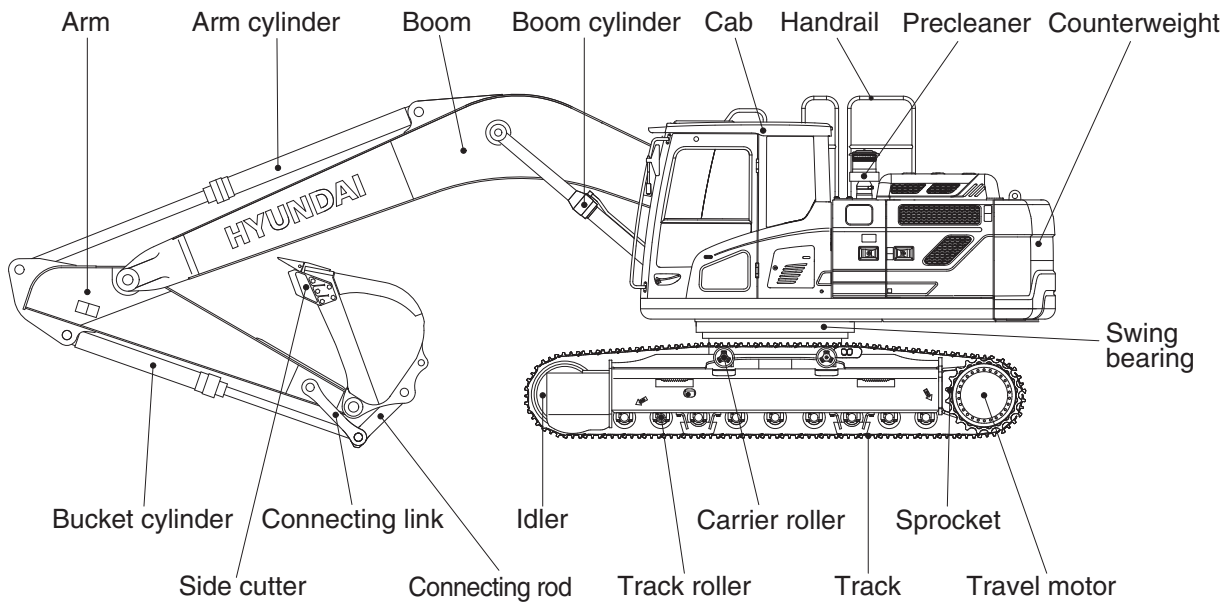
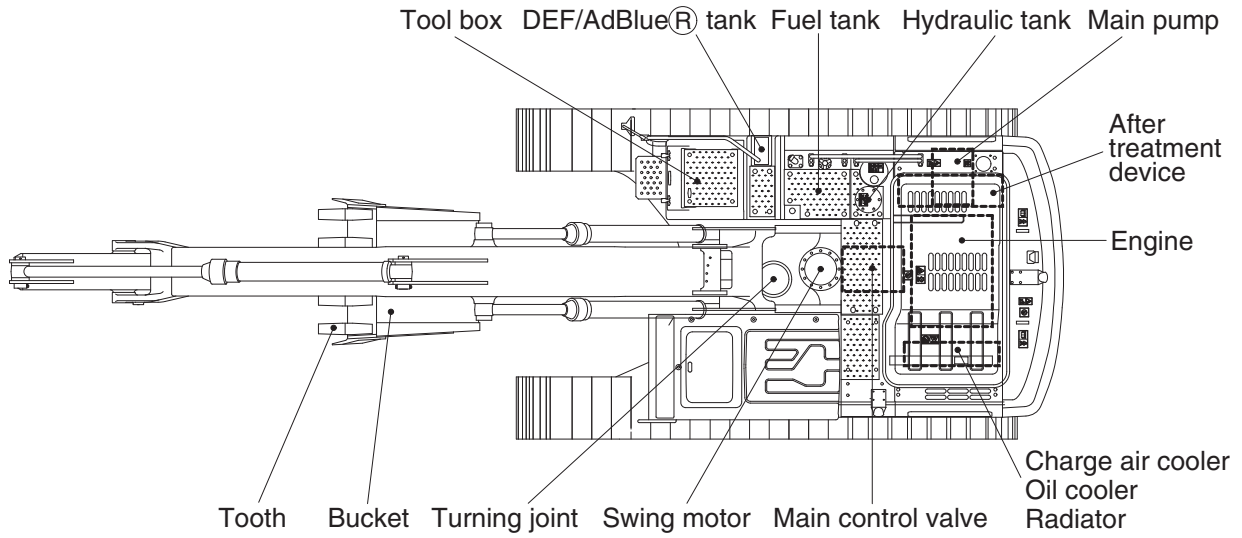

220F2SP01

2. SPECIFICATIONS

1) HX220 L

- 5.68 m (18' 8") BOOM and 2.92 m (9' 7") ARM

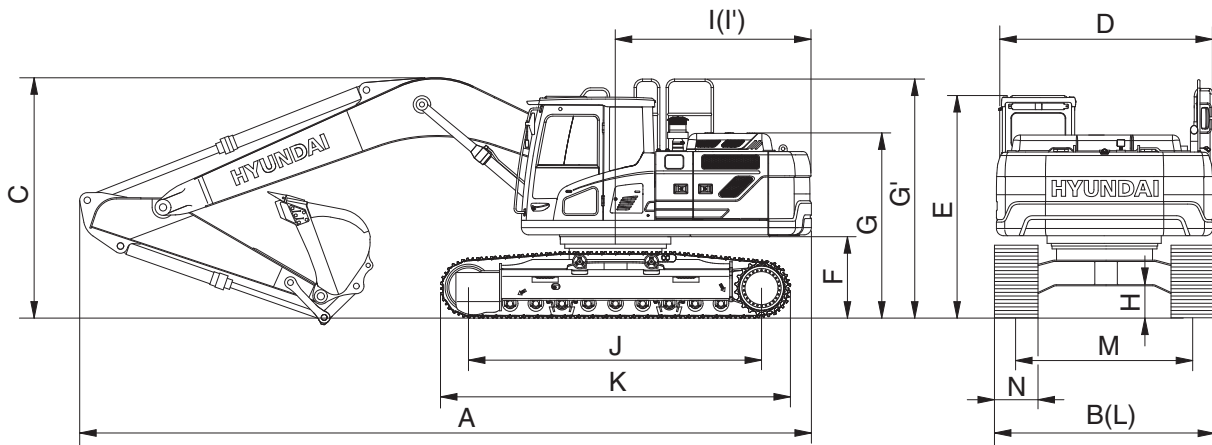

220F2SP02

Description	Unit	Specification
Operating weight	kg (lb)	22100 (48720)
Bucket capacity (SAE heaped), standard	m ³ (yd ³)	0.92 (1.20)
Overall length	A	9530 (31' 3")
Overall width, with 600mm shoe	B	2990 (9' 10")
Overall height of boom	C	3030 (9' 11")
Superstructure width	D	2740 (9' 0")
Overall height of cab	E	2920 (9' 7")
Ground clearance of counterweight	F	1060 (3' 6")
Engine cover height	G	2469 (8' 1")
Overall height of handrail	G'	3211 (10' 6")
Minimum ground clearance	H	480 (1' 7")
Rear-end distance	I	2770 (9' 1")
Rear-end swing radius	I'	2840 (9' 4")
Distance between tumblers	J	3650 (12' 0")
Undercarriage length	K	4440 (14' 7")
Undercarriage width	L	2990 (9' 10")
Track gauge	M	2390 (7' 10")
Track shoe width, standard	N	600 (24")
Travel speed (low/high)	km/hr (mph)	3.6/5.5 (2.2/3.4)
Swing speed	rpm	10.8
Gradeability	Degree (%)	35 (70)
Ground pressure (600 mm shoe)	kgf/cm ² (psi)	0.47 (6.68)
Max traction force	kg (lb)	20200 (44530)

2) HX220 L LONG REACH

- 8.2 m (26' 11") BOOM and 6.3 m (20' 8") ARM

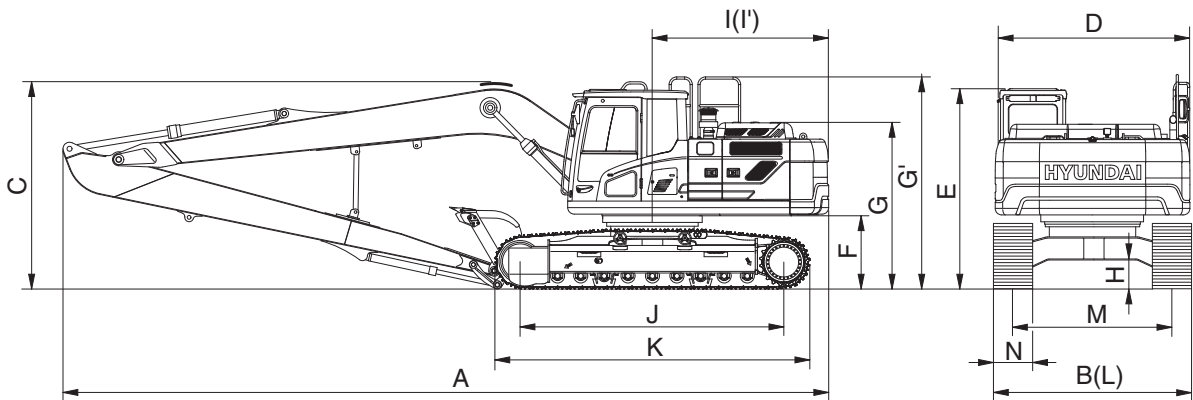

220F2SP03

Description		Unit	Specification
Operating weight		kg (lb)	24820 (54720)
Bucket capacity (SAE heaped), standard		m ³ (yd ³)	0.52 (0.68)
Overall length	A	mm (ft-in)	12030 (39' 6")
Overall width, with 800 mm shoe	B		3190 (10' 6")
Overall height	C		3280 (10' 9")
Superstructure width	D		2740 (9' 0")
Overall height of cab	E		2920 (9' 7")
Ground clearance of counterweight	F		1060 (3' 6")
Engine cover height	G		2469 (8' 1")
Overall height of handrail	G'		3211 (10' 6")
Minimum ground clearance	H		480 (1' 7")
Rear-end distance	I		2770 (9' 1")
Rear-end swing radius	I'		2840 (9' 4")
Distance between tumblers	J		3650 (12' 0")
Undercarriage length	K		4440 (14' 7")
Undercarriage width	L		3190 (10' 6")
Track gauge	M		2390 (7' 10")
Track shoe width	N		800 (32")
Travel speed (low/high)		km/hr (mph)	3.5/5.5 (2.2/3.4)
Swing speed		rpm	10.8
Gradeability		Degree (%)	35 (70)
Ground pressure (800 mm shoe)		kgf/cm ² (psi)	0.39 (5.55)
Max traction force		kg (lb)	20200 (44530)

3) HX220 L HIGH WALKER

· 5.68 m (18' 8") BOOM and 2.92 m (9' 7") ARM

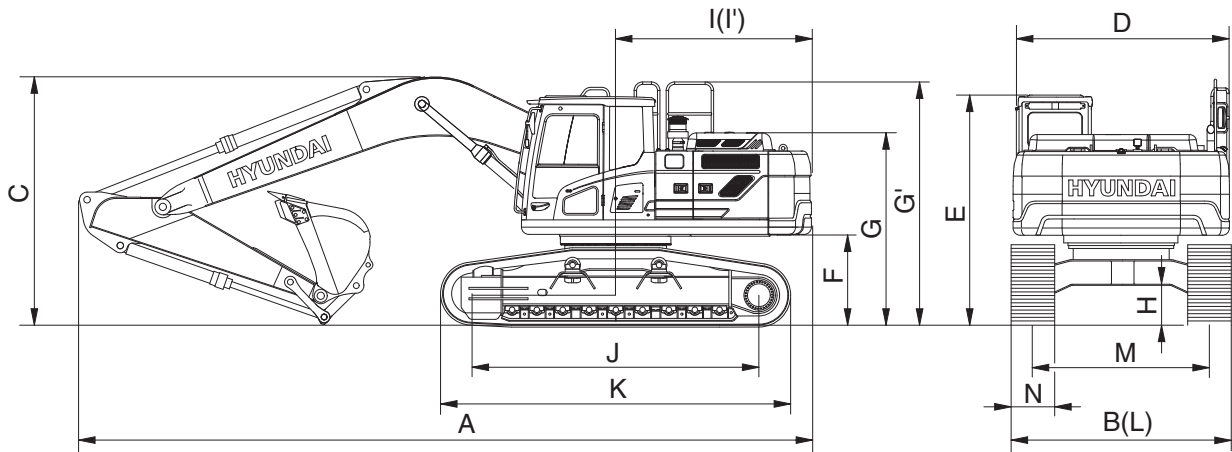

220F2SP04

Description		Unit	Specification
Operating weight		kg (lb)	23560 (51940)
Bucket capacity (SAE heaped), standard		m ³ (yd ³)	0.92 (1.20)
Overall length	A	mm (ft-in)	9470 (31' 1")
Overall width, with 600 mm shoe	B		3395 (11' 2")
Overall height	C		3060 (10' 0")
Superstructure width	D		2740 (9' 0")
Overall height of cab	E		3100 (10' 2")
Ground clearance of counterweight	F		1240 (4' 1")
Engine cover height	G		2649 (8' 8")
Overall height of handrail	G'		3391 (11' 2")
Minimum ground clearance	H		660 (2' 2")
Rear-end distance	I		2770 (9' 1")
Rear-end swing radius	I'		2840 (9' 4")
Distance between tumbler	J		3650 (12' 0")
Undercarriage length	K		4440 (14' 7")
Undercarriage width	L		3395 (11' 2")
Track gauge	M		2795 (9' 2")
Track shoe width, standard	N		600 (24")
Travel speed (low/high)		km/hr (mph)	3.6/5.5 (2.2/3.4)
Swing speed		rpm	10.8
Gradeability		Degree (%)	35 (70)
Ground pressure (600 mm shoe)		kgf/cm ² (psi)	0.50 (7.11)
Max traction force		kg (lb)	20200 (44530)

3. WORKING RANGE

1) HX220 L

· 5.68 m (18' 8") BOOM

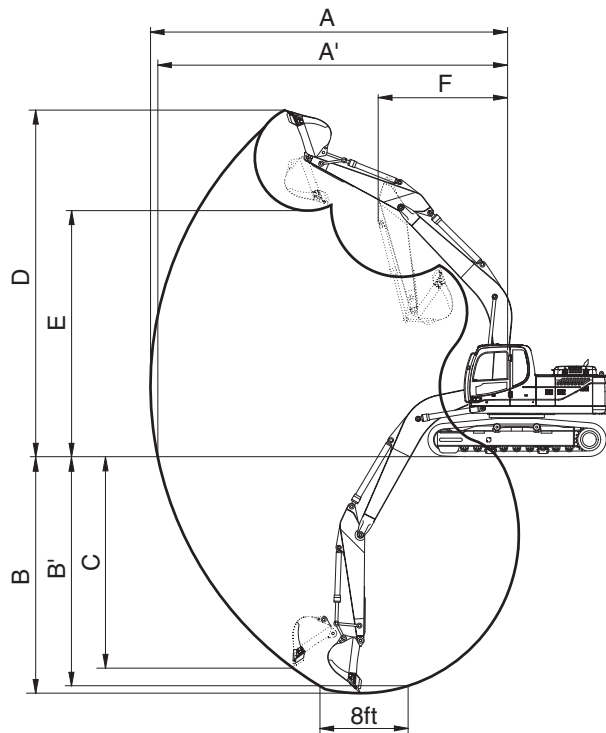

21092SP03

Description		2.0 m (6' 7") Arm	2.40 m (7' 10") Arm	2.92 m (9' 7") Arm	3.90 m (12' 10") Arm	
Max digging reach	A	9140 mm (30' 0")	9500 mm (31' 2")	9980 mm (32' 9")	10910 mm (35' 10")	
Max digging reach on ground	A'	8960 mm (29' 5")	9330 mm (30' 7")	9820 mm (32' 3")	10770 mm (35' 4")	
Max digging depth	B	5820 mm (19' 1")	6220 mm (20' 5")	6730 mm (22' 1")	7720 mm (25' 4")	
Max digging depth (8 ft level)	B'	5580 mm (18' 4")	6010 mm (19' 9")	6560 mm (21' 6")	7580 mm (24' 10")	
Max vertical wall digging depth	C	5280 mm (17' 4")	5720 mm (18' 9")	6280 mm (20' 7")	7240 mm (23' 9")	
Max digging height	D	9140 mm (30' 0")	9340 mm (30' 8")	9600 mm (31' 6")	10110 mm (33' 2")	
Max dumping height	E	6330 mm (20' 9")	6520 mm (21' 5")	6780 mm (22' 3")	7290 mm (23' 11")	
Min swing radius	F	3750 mm (12' 4")	3740 mm (12' 3")	3670 mm (12' 0")	3700 mm (12' 2")	
Bucket digging force	SAE	[]	133.4 [144.8] kN	133.4 [144.8] kN	133.4 [144.8] kN	133.4 [144.8] kN
			13600 [14770] kgf	13600 [14770] kgf	13600 [14770] kgf	13600 [14770] kgf
			29980 [32550] lbf	29980 [32550] lbf	29980 [32550] lbf	29980 [32550] lbf
	ISO	[]	152.0 [165.0] kN	152.0 [165.0] kN	152.0 [165.0] kN	152.0 [165.0] kN
			15500 [16830] kgf	15500 [16830] kgf	15500 [16830] kgf	15500 [16830] kgf
			34170 [37100] lbf	34170 [37100] lbf	34170 [37100] lbf	34170 [37100] lbf
Arm digging force	SAE	[]	144.2 [156.5] kN	119.6 [129.9] kN	102.0 [110.7] kN	84.3 [91.6] kN
			14700 [15960] kgf	12200 [13250] kgf	10400 [11290] kgf	8600 [9340] kgf
			32410 [35190] lbf	26900 [29210] lbf	22930 [24900] lbf	18960 [20590] lbf
	ISO	[]	151.0 [164.0] kN	125.5 [136.3] kN	106.9 [116.1] kN	87.3 [94.8] kN
			15400 [16720] kgf	12800 [13900] kgf	10900 [11830] kgf	8900 [9660] kgf
			33950 [36860] lbf	28220 [30640] lbf	24030 [26090] lbf	19620 [21300] lbf

[] : Power boost

2) HX220 L LONG REACH

· 8.2 m (26' 11") BOOM

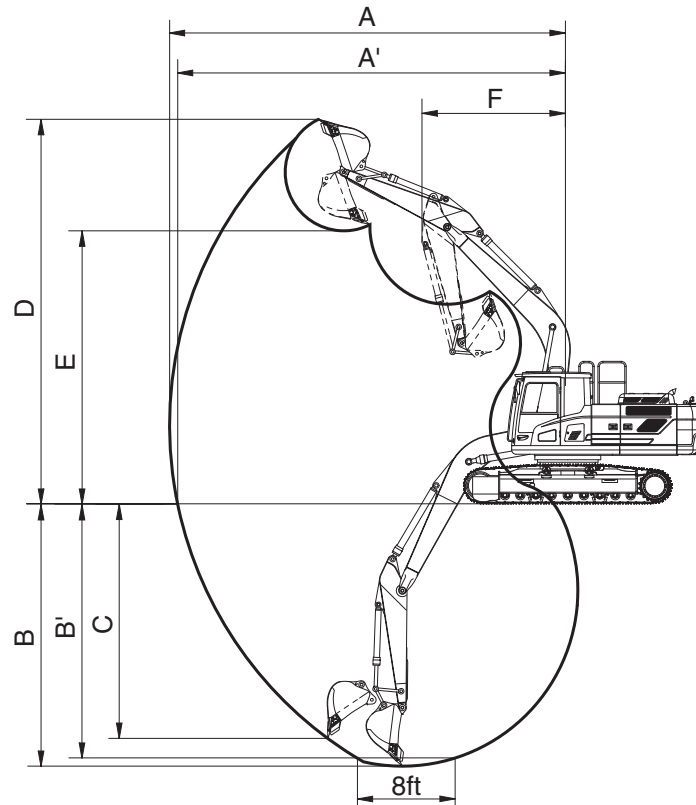

220F2SP05

Description		6.3 m (20' 8") Arm	
Max digging reach	A	15220 (50' 0")	
Max digging reach on ground	A'	15120 (49' 7")	
Max digging depth	B	11760 (38' 7")	
Max digging depth (8 ft level)	B'	11650 (38' 3")	
Max vertical wall digging depth	C	9610 (31' 6")	
Max digging height	D	12550 (41' 2")	
Max dumping height	E	10280 (33' 8")	
Min swing radius	F	4870 (16' 0")	
Bucket digging force	SAE	72.6 kN	
		7400 kgf	
		16310 lbf	
	ISO	83.4 kN	
		8500 kgf	
		18740 lbf	
Arm crowd force	SAE	49.0 kN	
		5000 kgf	
		11020 lbf	
	ISO	50.0 kN	
		5100 kgf	
		11240 lbf	

3) HX220 L HIGH WALKER

· 5.68 m (18' 8") BOOM

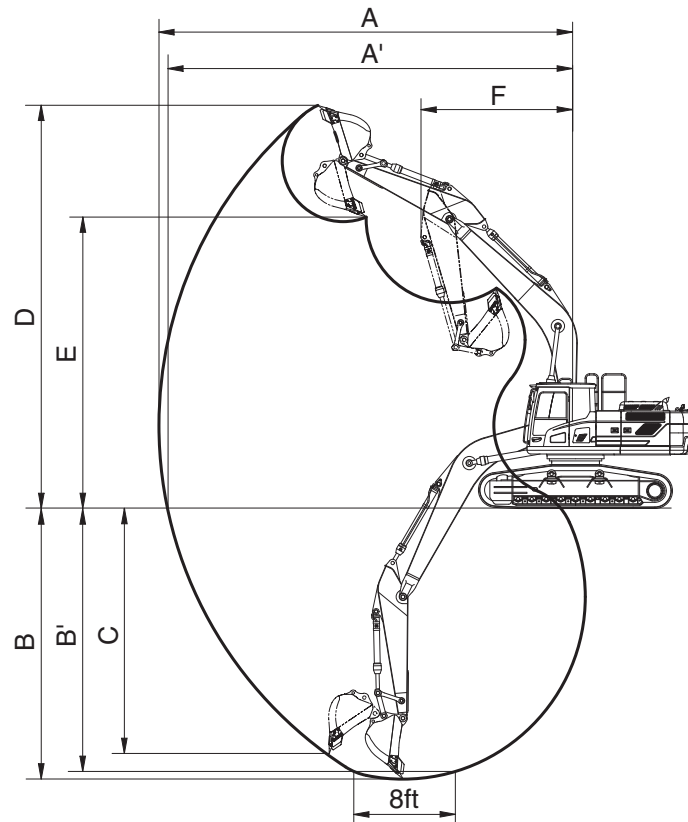

220F2SP06

Description		2.0 m (6' 7") Arm	2.40 m (7' 10") Arm	2.92 m (9' 7") Arm	3.90 m (12'10") Arm
Max digging reach	A	9140 mm (30' 0")	9500 mm (31' 2")	9980 mm (32' 9")	10910 mm (35'10")
Max digging reach on ground	A'	8920 mm (29' 3")	9290 mm (30' 6")	9820 mm (32' 3")	10730 mm (35' 2")
Max digging depth	B	5630 mm (18' 6")	6010 mm (19' 9")	6550 mm (21' 6")	7530 mm (24' 8")
Max digging depth (8 ft level)	B'	5390 mm (17' 8")	5820 mm (19' 1")	6380 mm (20'11")	7390 mm (24' 3")
Max vertical wall digging depth	C	5090 mm (16' 8")	5630 mm (18' 6")	6100 mm (20' 0")	7050 mm (23' 1")
Max digging height	D	9330 mm (30' 7")	9530 mm (31' 3")	9780 mm (32' 1")	10300 mm (33' 9")
Max dumping height	E	6520 mm (21' 5")	6710 mm (22' 0")	6960 mm (22'10")	7480 mm (24' 6")
Min swing radius	F	3750 mm (12' 4")	3740 mm (12' 3")	3670 mm (12' 0")	3700 mm (12' 2")
Bucket digging force	SAE	133.4 [144.8] kN	133.4 [144.8] kN	133.4 [144.8] kN	133.4 [144.8] kN
		13600 [14770] kgf	13600 [14770] kgf	13600 [14770] kgf	13600 [14770] kgf
		29980 [32550] lbf	29980 [32550] lbf	29980 [32550] lbf	29980 [32550] lbf
	ISO	152.0 [165.0] kN	152.0 [165.0] kN	152.0 [165.0] kN	152.0 [165.0] kN
		15500 [16830] kgf	15500 [16830] kgf	15500 [16830] kgf	15500 [16830] kgf
		34170 [37100] lbf	34170 [37100] lbf	34170 [37100] lbf	34170 [37100] lbf
Arm crowd force	SAE	144.2 [156.5] kN	119.6 [129.9] kN	102.0 [110.7] kN	84.3 [91.6] kN
		14700 [15960] kgf	12200 [13250] kgf	10400 [11290] kgf	8600 [9340] kgf
		32410 [35190] lbf	26900 [29210] lbf	22930 [24900] lbf	18960 [20590] lbf
	ISO	151.0 [164.0] kN	125.5 [136.3] kN	106.9 [116.1] kN	87.3 [94.8] kN
		15400 [16720] kgf	12800 [13900] kgf	10900 [11830] kgf	8900 [9660] kgf
		33950 [36860] lbf	28220 [30640] lbf	24030 [26090] lbf	19620 [21300] lbf

[] : Power boost

4. WEIGHT

1) HX220 L

Item	HX220 L	
	kg	lb
Upper structure assembly		
· Main frame weld assembly	1880	4140
· Engine assembly	520	1150
· Main pump assembly	140	310
· Main control valve assembly	220	485
· Swing motor assembly	240	530
· Hydraulic oil tank assembly	240	530
· Fuel tank assembly	195	430
· Counterweight	3800	8380
· Cab assembly	490	1080
Lower chassis assembly		
· Track frame weld assembly	2720	6000
· Swing bearing	290	640
· Travel motor assembly	300	660
· Turning joint	55	120
· Sprocket	55	120
· Track recoil spring	130	290
· Idler	155	340
· Carrier roller	20	45
· Track roller	48	106
· Track-chain assembly (600 mm standard triple grouser shoe)	1360	3000
Front attachment assembly		
· 5.68 m boom assembly	1520	3350
· 2.92 m arm assembly	760	1680
· 0.92 m ³ SAE heaped bucket	820	1810
· Boom cylinder assembly	180	400
· Arm cylinder assembly	290	640
· Bucket cylinder assembly	175	390
· Bucket control link assembly	170	370

※ This information is different with operating and transportation weight because it is not including harness, pipe, oil, fuel so on.

※ Refer to Transportation for actual weight information and Specifications for operating weight.

2) HX220 L LONG REACH

Item	HX220 L LONG REACH	
	kg	lb
Upper structure assembly		
· Main frame weld assembly	1880	4140
· Engine assembly	520	1150
· Main pump assembly	140	310
· Main control valve assembly	220	485
· Swing motor assembly	240	530
· Hydraulic oil tank assembly	240	530
· Fuel tank assembly	195	430
· Counterweight	5300	11680
· Cab assembly	490	1080
Lower chassis assembly		
· Track frame weld assembly	2720	6000
· Swing bearing	290	640
· Travel motor assembly	300	660
· Turning joint	55	120
· Sprocket	55	120
· Track recoil spring	130	290
· Idler	155	340
· Carrier roller	20	45
· Track roller	48	106
· Track-chain assembly (600 mm standard triple grouser shoe)	1735	3820
Front attachment assembly		
· 8.2 m boom assembly	2105	4640
· 6.3 m arm assembly	1100	2430
· 0.52 m ³ SAE heaped bucket	460	1010
· Boom cylinder assembly	180	400
· Arm cylinder assembly	270	600
· Bucket cylinder assembly	130	290
· Bucket control link assembly	170	370

※ This information is different with operating and transportation weight because it is not including harness, pipe, oil, fuel so on.

※ Refer to Transportation for actual weight information and Specifications for operating weight.

3) HX220 L HIGH WALKER

Item	HX220 L HIGH WALKER	
	kg	lb
Upper structure assembly		
· Main frame weld assembly	1950	4300
· Engine assembly	520	1150
· Main pump assembly	140	310
· Main control valve assembly	220	485
· Swing motor assembly	240	530
· Hydraulic oil tank assembly	240	530
· Fuel tank assembly	195	430
· Counterweight	3800	8380
· Cab assembly	490	1080
Lower chassis assembly		
· Track frame weld assembly	3730	8220
· Swing bearing	290	640
· Travel motor assembly	300	660
· Turning joint	55	120
· Sprocket	55	120
· Track recoil spring	130	290
· Idler	155	340
· Carrier roller	20	45
· Track roller	48	106
· Track-chain assembly (600 mm standard triple grouser shoe)	1360	3000
Front attachment assembly		
· 5.68 m boom assembly	1520	3350
· 2.92 m arm assembly	760	1680
· 0.92 m ³ SAE heaped bucket	820	1810
· Boom cylinder assembly	180	400
· Arm cylinder assembly	290	640
· Bucket cylinder assembly	175	390
· Bucket control link assembly	170	370

※ This information is different with operating and transportation weight because it is not including harness, pipe, oil, fuel so on.

※ Refer to Transportation for actual weight information and Specifications for operating weight.











5. LIFTING CAPACITIES

1) HX220 L

(1) 5.68 m (18' 8") boom, 2.00 m (6' 7") arm equipped with 0.92 m³ (SAE heaped) bucket, 600 mm (24") triple grouser shoe.

•  : Rating over-front

•  : Rating over-side or 360 degree

Load point height		Load radius								At max. reach		
		3.0 m (10 ft)		4.5 m (15 ft)		6.0 m (20 ft)		7.5 m (25 ft)		Capacity		Reach
												m (ft)
7.5 m (25 ft)	kg lb									*3970 *8750	*3970 *8750	6.65 (21.8)
6.0 m (20 ft)	kg lb					*4400 *9700	*4400 *9700			*4020 *8860	3030 6680	7.78 (25.5)
4.5 m (15 ft)	kg lb			*5690 *12540	*5690 *12540	*4820 *10630	4640 10230			*4140 *9130	2530 5580	8.43 (27.7)
3.0 m (10 ft)	kg lb			*7420 *16360	6860 15120	*5570 *12280	4370 9630	*4780 *10540	3000 6610	4050 8930	2300 5070	8.74 (28.7)
1.5 m (5 ft)	kg lb			*8940 *19710	6340 13980	*6340 *13980	4120 9080	5080 11200	2880 6350	3990 8800	2250 4960	8.73 (28.6)
Ground Line	kg lb			*9640 *21250	6110 13470	*6860 *15120	3960 8730	4990 11000	2810 6190	4210 9280	2370 5220	8.42 (27.6)
-1.5 m (-5 ft)	kg lb	*13940 *30730	12320 27160	*9580 *21120	6090 13430	*6950 *15320	3910 8620			4830 10650	2750 6060	7.76 (25.5)
-3.0 m (-10 ft)	kg lb	*12450 *27450	*12450 *27450	*8770 *19330	6200 13670	*6310 *13910	4000 8820			*4800 *10580	3650 8050	6.61 (21.7)
-4.5 m (-15 ft)	kg lb	*9410 *20750	*9410 *20750									

- Note
1. Lifting capacity are based on SAE J1097 and ISO 10567.
 2. Lifting capacity of the ROBEX series does not exceed 75% of tipping load with the machine on firm, level ground or 87% of full hydraulic capacity.
 3. The load point is a hook located on the back of the bucket.
 4. *indicates load limited by hydraulic capacity.

※ **Lifting capacities are based upon a standard machine conditions.**

Lifting capacities will vary with different work tools, ground conditions and attachments.













The difference between the weight of a work tool attachment must be subtracted.

Consult your Hyundai dealer regarding the lifting capacities for specific work tools and attachments.

▲ Failure to comply to the rated load can cause possible personal injury or property damage. Make adjustments to the rated load as necessary for non-standard configurations.













(2) 5.68 m (18' 8") boom, 2.40 m (7' 10") arm equipped with 0.92 m³ (SAE heaped) bucket and 600 mm (24") triple grouser shoe.

·  : Rating over-front ·  : Rating over-side or 360 degree

Load point height		Load radius										At max. reach		
		1.5 m (5 ft)		3.0 m (10 ft)		4.5 m (15 ft)		6.0 m (20 ft)		7.5 m (25 ft)		Capacity		Reach
														m (ft)
7.5 m (25 ft)	kg lb											*3660 *8070	3640 8020	7.15 (23.5)
6.0 m (20 ft)	kg lb						*3970 *8750	*3970 *8750				*3730 *8220	2750 6060	8.20 (26.9)
4.5 m (15 ft)	kg lb						*4450 *9810	*4450 *9810	*4190 *9240	3120 6880		*3860 *8510	2320 5110	8.82 (28.9)
3.0 m (10 ft)	kg lb				*6850 *15100	*6850 *15100	*5240 *11550	4410 9720	*4520 *9960	3010 6640		3760 8290	2120 4670	9.11 (29.9)
1.5 m (5 ft)	kg lb				*8510 *18760	6400 14110	*6080 *13400	4130 9110	*4930 *10870	2880 6350		3710 8180	2070 4560	9.10 (29.9)
Ground Line	kg lb			*8830 *19470	*8830 *19470	*9440 *20810	6100 13450	*6700 *14770	3940 8690	4960 10930	2770 6110	3890 8580	2170 4780	8.18 (26.8)
-1.5 m (-5 ft)	kg lb	*9800 *21610	*9800 *21610	*13550 *29870	12120 26720	*9610 *21190	6020 13270	*6920 *15260	3860 8510			4400 9700	2480 5470	7.12 (23.4)
-3.0 m (-10 ft)	kg lb	*14180 *31260	*14180 *31260	*13180 *29060	12340 27210	*9040 *19930	6100 13450	*6540 *14420	3900 8600			*4660 *10270	3190 7030	
-4.5 m (-15 ft)	kg lb			*10580 *23320	*10580 *23320	*7350 *16200	6350 14000							



(3) 5.68 m (18' 8") boom, 2.92 m (9' 7") arm equipped with 0.92 m³ (SAE heaped) bucket and 600 mm (24") triple grouser shoe.

















·  : Rating over-front ·  : Rating over-side or 360 degree

Load point height		Load radius										At max. reach		
		1.5 m (5 ft)		3.0 m (10 ft)		4.5 m (15 ft)		6.0 m (20 ft)		7.5 m (25 ft)		Capacity		Reach
														m (ft)
7.5 m (25 ft)	kg lb											*3310 *7300	3140 6920	7.78 (25.5)
6.0 m (20 ft)	kg lb								*2300 *5070	*2300 *5070		*3400 *7500	2450 5400	8.74 (28.7)
4.5 m (15 ft)	kg lb							*3970 *8750	*3970 *8750	*3780 6990	3170 6990	*3530 *7780	2090 4610	9.32 (30.6)
3.0 m (10 ft)	kg lb			*9720 *21430	*9720 *21430	*6100 *13450	*6100 *13450	*4790 *10560	4460 9830	*4180 *9220	3030 6680	3440 7580	1910 4210	9.59 (31.5)
1.5 m (5 ft)	kg lb			*8850 *19510	*8850 *19510	*7900 *17420	6500 14330	*5700 *12570	4150 9150	*4660 *10270	2870 6330	3380 7450	1860 4100	9.59 (31.5)
Ground Line	kg lb			*9590 *21140	*9590 *21140	*9100 *20060	6100 13450	*6440 *14200	3920 8640	4930 10870	2740 6040	3520 7760	1930 4250	9.31 (30.5)
-1.5 m (-5 ft)	kg lb	*8840 *19490	*8840 *19490	*12650 *27980	11920 26280	*9540 *21030	5940 13100	*6810 *15010	3800 8380	4860 10710	2680 5910	3910 8620	2170 4780	8.72 (28.6)
-3.0 m (-10 ft)	kg lb	*12230 *26960	*12230 *26960	*13910 *30670	12080 26630	*9260 *20410	5960 13140	*6690 *14750	3800 8380			*4420 *9740	2700 5950	7.75 (25.4)
-4.5 m (-15 ft)	kg lb			*11800 *26010	*11800 *26010	*8060 *17770	6150 13560					*4280 *9440	4080 8990	6.16 (20.2)

2) HX220 L LONG REACH

(1) 8.2 m (26' 11") boom, 6.3 m (20' 8") arm equipped with 0.52 m³ (SAE heaped) bucket and 800 mm (32") triple grouser shoe.

·  : Rating over-front ·  : Rating over-side or 360 degree

Load point height		Load radius														At max. reach			
		4.5 m (15 ft)		6.0 m (20 ft)		7.5 m (25 ft)		9.0 m (30 ft)		10.5 m (35 ft)		12.0 m (40 ft)		13.5 m (45 ft)		Capacity	Reach		
																		m (ft)	
10.5 m (35 ft)	kg																*1470	*1470	12.11
	lb																*3240	*3240	(39.7)
9.0 m (30 ft)	kg											*930	*930				*1490	*1490	13.11
	lb											*2050	*2050				*3280	*3280	(43.0)
7.5 m (25 ft)	kg											*1540	*1540				*1530	1350	13.84
	lb											*3400	*3400				*3370	2980	(45.4)
6.0 m (20 ft)	kg									*1590	*1590	*1600	*1600				*1580	1190	14.37
	lb									*3510	*3510	*3530	*3530				*3480	2620	(47.1)
4.5 m (15 ft)	kg									*1770	*1770	*1710	*1710	*1260	*1260		*1630	1080	14.72
	lb									*3900	*3900	*3770	*3770	*2780	*2780		*3590	2380	(48.3)
3.0 m (10 ft)	kg					*2500	*2500	*2200	*2200	*2000	*2000	*1860	1670	*1590	1260		*1700	1010	14.89
	lb					*5510	*5510	*4850	*4850	*4410	*4410	*4100	3680	*3510	2780		*3750	2230	(48.9)
1.5 m (5 ft)	kg	*5570	*5570	*3900	*3900	*3060	*3060	*2560	*2560	*2240	2050	*2030	1570	*1790	1200		*1780	970	14.90
	lb	*12280	*12280	*8600	*8600	*6750	*6750	*5640	*5640	*4940	4520	*4480	3460	*3950	2650		*3920	2140	(48.9)
Ground Line	kg	*6930	6870	*4720	4590	*3580	3320	*2910	2490	*2490	1910	*2200	1480	*1820	1140		*1860	960	14.75
	lb	*15280	15150	*10410	10120	*7890	7320	*6420	5490	*5490	4210	*4850	3260	*4010	2510		*4100	2120	(48.4)
-1.5 m (-5 ft)	kg	*7750	6340	*5330	4220	*4020	3060	*3220	2320	*2700	1790	*2350	1400	*1570	1100		*1960	990	14.42
	lb	*17090	13980	*11750	9300	*8860	6750	*7100	5110	*5950	3950	*5180	3090	*3460	2430		*4320	2180	(47.3)
-3.0 m (-10 ft)	kg	*8150	6120	*5720	4000	*4330	2890	*3450	2190	*2870	1700	*2460	1340				*2060	1050	13.92
	lb	*17970	13490	*12610	8820	*9550	6370	*7610	4830	*6330	3750	*5420	2950				*4540	2310	(45.7)
-4.5 m (-15 ft)	kg	*8220	6060	*5890	3910	*4490	2810	*3590	2120	*2960	1660	*2490	1330				*2180	1170	13.20
	lb	*18120	13360	*12990	8620	*9900	6190	*7910	4670	*6530	3660	*5490	2930				*4810	2580	(43.3)
-6.0 m (-20 ft)	kg	*8020	6130	*5840	3920	*4500	2790	*3600	2110	*2940	1660						*2310	1370	12.25
	lb	*17680	13510	*12870	8640	*9920	6150	*7940	4650	*6480	3660						*5090	3020	(40.2)
-7.5 m (-25 ft)	kg	*7500	6310	*5550	4010	*4300	2850	*3420	2170	*2700	1730						*2430	1710	10.97
	lb	*16530	13910	*12240	8840	*9480	6280	*7540	4780	*5950	3810						*5360	3770	(36.0)
-9.0 m (-30 ft)	kg	*6570	*6570	*4920	4200	*3790	3000	*2890	2320										
	lb	*14480	*14480	*10850	9260	*8360	6610	*6370	5110										
-10.5 m (-35 ft)	kg	*4970	*4970	*3680	*3680														
	lb	*10960	*10960	*8110	*8110														











- Note
1. Lifting capacity are based on SAE J1097 and ISO 10567.
 2. Lifting capacity of the ROBEX series does not exceed 75% of tipping load with the machine on firm, level ground or 87% of full hydraulic capacity.
 3. The load point is a hook located on the back of the bucket.
 4. *indicates load limited by hydraulic capacity.

3) HX220 L HIGH WALKER

(1) 5.68 m (18' 8") boom, 2.00 m (6' 7") arm equipped with 0.92 m³ (SAE heaped) bucket, 600 mm (24") triple grouser shoe.

·  : Rating over-front













·  : Rating over-side or 360 degree

Load point height		Load radius								At max. reach		
		3.0 m (10 ft)		4.5 m (15 ft)		6.0 m (20 ft)		7.5 m (25 ft)		Capacity		Reach
												m (ft)
7.5 m (25 ft)	kg lb									*3970 *8750	*3970 *8750	6.65 (21.8)
6.0 m (20 ft)	kg lb					*4400 *9700	*4400 *9700			*4020 *8860	3920 8640	7.78 (25.5)
4.5 m (15 ft)	kg lb			*5690 *12540	*5690 *12540	*4820 *10630	*4820 *10630			*4140 *9130	3330 7340	8.43 (27.7)
3.0 m (10 ft)	kg lb			*7420 *16360	*7420 *16360	*5570 *12280	*5570 *12280	*4780 *10540	3930 8660	*4300 *9480	3060 6750	8.74 (28.7)
1.5 m (5 ft)	kg lb			*8940 *19710	8430 18580	*6340 *13980	5420 11950	*5140 *11330	3810 8400	4300 9480	3010 6640	8.73 (28.6)
Ground Line	kg lb			*9640 *21250	8190 18060	*6860 *15120	5250 11570	*5370 *11840	3730 8220	4540 10010	3170 6990	8.42 (27.6)
-1.5 m (-5 ft)	kg lb	*13940 *30730	*13940 *30730	*9580 *21120	8160 17990	*6950 *15320	5190 11440			*4840 *10670	3630 8000	7.76 (25.5)
-3.0 m (-10 ft)	kg lb	*12450 *27450	*12450 *27450	*8770 *19330	8290 18280	*6310 *13910	5290 11660			*4800 *10580	4780 10540	6.61 (21.7)
-4.5 m (-15 ft)	kg lb	*9410 *20750	*9410 *20750									

- Note
1. Lifting capacity are based on SAE J1097 and ISO 10567.
 2. Lifting capacity of the ROBEX series does not exceed 75% of tipping load with the machine on firm, level ground or 87% of full hydraulic capacity.
 3. The load point is a hook located on the back of the bucket.
 4. *indicates load limited by hydraulic capacity.













(2) 5.68 m (18' 8") boom, 2.40 m (7' 10") arm equipped with 0.92 m³ (SAE heaped) bucket, 600 mm (24") triple grouser shoe.

·  : Rating over-front ·  : Rating over-side or 360 degree

Load point height		Load radius										At max. reach		
		1.5 m (5 ft)		3.0 m (10 ft)		4.5 m (15 ft)		6.0 m (20 ft)		7.5 m (25 ft)		Capacity		Reach
														m (ft)
7.5 m (25 ft)	kg lb											*3660 *8070	*3660 *8070	7.15 (23.5)
6.0 m (20 ft)	kg lb						*3970 *8750	*3970 *8750				*3730 *8220	3580 7890	8.20 (26.9)
4.5 m (15 ft)	kg lb						*4450 *9810	*4450 *9810	*4190 *9240	4060 8950	*3860 *8510	3070 6770	8.82 (28.9)	
3.0 m (10 ft)	kg lb				*6850 *15100	*6850 *15100	*5240 *11550	*5240 *11550	*4520 *9960	3940 8690	*4020 *8860	2840 6260	9.11 (29.9)	
1.5 m (5 ft)	kg lb				*8510 *18760	8500 18740	*6080 *13400	5430 11970	*4930 *10870	3810 8400	4010 8840	2780 6130	9.10 (29.9)	
Ground Line	kg lb			*8830 *19470	*8830 *19470	*9440 *20810	8180 18030	*6700 *14770	5230 11530	*5250 *11570	3700 8160	4200 9260	2920 6440	8.81 (28.9)
-1.5 m (-5 ft)	kg lb	*9800 *21610	*9800 *21610	*13550 *29870	*13550 *29870	*9610 *21190	8090 17840	*6920 *15260	5140 11330			*4590 *10120	3300 7280	8.18 (26.8)
-3.0 m (-10 ft)	kg lb	*14180 *31260	*14180 *31260	*13180 *29060	*13180 *29060	*9040 *19930	8170 18010	*6540 *14420	5190 11440			*4660 *10270	4190 9240	7.12 (23.4)
-4.5 m (-15 ft)	kg lb			*10580 *23320	*10580 *23320	*7350 *16200	*7350 *16200							

(3) 5.68 m (18' 8") boom, 2.92 m (9' 7") arm equipped with 0.92 m³ (SAE heaped) bucket, 600 mm (24") triple grouser shoe.















·  : Rating over-front ·  : Rating over-side or 360 degree

Load point height		Load radius										At max. reach		
		1.5 m (5 ft)		3.0 m (10 ft)		4.5 m (15 ft)		6.0 m (20 ft)		7.5 m (25 ft)		Capacity		Reach
														m (ft)
7.5 m (25 ft)	kg lb											*3310 *7300	*3310 *7300	7.78 (25.5)
6.0 m (20 ft)	kg lb								*2300 *5070	*2300 *5070	*3400 *7500	3210 7080	8.74 (28.7)	
4.5 m (15 ft)	kg lb							*3970 *8750	*3970 *8750	*3780 *8330	*3780 *8330	*3530 *7780	2780 6130	9.32 (30.6)
3.0 m (10 ft)	kg lb			*9720 *21430	*9720 *21430	*6100 *13450	*6100 *13450	*4790 *10560	*4790 *10560	*4180 *9220	3970 8750	*3680 *8110	2580 5690	9.59 (31.5)
1.5 m (5 ft)	kg lb			*8850 *19510	*8850 *19510	*7900 *17420	*7900 *17420	*5700 *12570	5450 12020	*4660 *10270	3800 8380	3660 8070	2530 5580	9.59 (31.5)
Ground Line	kg lb			*9590 *21140	*9590 *21140	*9100 *20060	8180 18030	*6440 *14200	5210 11490	*5060 *11160	3670 8090	3810 8400	2630 5800	9.31 (30.5)
-1.5 m (-5 ft)	kg lb	*8840 *19490	*8840 *19490	*12650 *27890	*12650 *27890	*9540 *21030	8010 17660	*6810 *15010	5080 11200	5240 11550	3610 7960	4230 9330	2930 6460	8.72 (28.6)
-3.0 m (-10 ft)	kg lb	*12230 *26960	*12230 *26960	*13910 *30670	*13910 *30670	*9260 *20410	8040 17730	*6690 *14750	5080 11200			*4420 *9740	3590 7910	7.75 (25.4)
-4.5 m (-15 ft)	kg lb			*11800 *26010	*11800 *26010	*8060 *17770	*8060 *17770					*4280 *9440	*4280 *9440	6.16 (20.2)

(4) 5.68 m (18' 8") boom, 3.90 m (12' 9") arm equipped with 0.92 m³ (SAE heaped) bucket and 600 mm (24") triple grouser shoe.

·  : Rating over-front

·  : Rating over-side or 360 degree

Load point height		Load radius												At max. reach			
		1.5 m (5 ft)		3.0 m (10 ft)		4.5 m (15 ft)		6.0 m (20 ft)		7.5 m (25 ft)		9.0 m (30 ft)		Capacity		Reach	
																m (ft)	
9.0 m (30 ft)	kg														*2700	*2700	7.66
	lb														*5950	*5950	(25.1)
7.5 m (25 ft)	kg									*1940	*1940				*2760	*2760	8.94
	lb									*4280	*4280				*6080	*6080	29.3
6.0 m (20 ft)	kg									*2790	*2790				*2850	2600	9.77
	lb									*6150	*6150				*6280	5730	(32.1)
4.5 m (15 ft)	kg									*3050	*3050	*2000	*2000	*2970	2300	10.28	
	lb									*6720	*6720	*4410	*4410	*6550	5070	(33.7)	
3.0 m (10 ft)	kg							*3900	*3900	*3510	*3510	*2870	2860	*3110	2140	10.52	
	lb							*8600	*8600	*7740	*7740	*6330	6310	*6860	4720	(34.5)	
1.5 m (5 ft)	kg			*11080	*11080	*6600	*6600	*4900	*4900	*4080	3820	*3410	2760	3080	2090	10.52	
	lb			*24430	*24430	*14550	*14550	*10800	*10800	*8990	8420	*7520	6080	6790	4610	(34.5)	
Ground Line	kg	*5300	*5300	*10640	*10640	*8200	*8200	*5820	5210	*4610	3630	*3490	2660	3180	2150	10.27	
	lb	*11680	*11680	*23460	*23460	*18080	*18080	*12830	11490	*10160	8000	*7690	5860	7010	4740	(33.7)	
-1.5 m (-5 ft)	kg	*7540	*7540	*11690	*11690	*9110	7900	*6440	4990	*4990	3510	*2330	*2330	3450	2340	9.75	
	lb	*16620	*16620	*25770	*25770	*20080	17420	*14200	11000	*11000	7740	*5140	*5140	7610	5160	(32.0)	
-3.0 m (-10 ft)	kg	*10030	*10030	*14390	*14390	*9320	7800	*6660	4910	*5070	3470			*3850	2750	8.91	
	lb	*22110	*22110	*31720	*31720	*20550	17200	*14680	10820	*11180	7650			*8490	6060	29.2	
-4.5 m (-15 ft)	kg	*13000	*13000	*13310	*13310	*8780	7890	*6290	4960					*3990	3640	7.62	
	lb	*28660	*28660	*29340	*29340	*19360	17390	*13870	10930					*8800	8020	(25.0)	
-6.0 m (-20 ft)	kg			*10560	*10560	*7050	*7050										
	lb			*23280	*23280	*15540	*15540										

6. BUCKET SELECTION GUIDE

1) GENERAL BUCKET

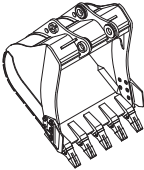
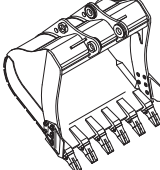
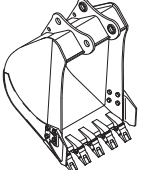
		
0.80, 0.92, 1.10, 1.20 m ³ SAE heaped bucket	1.34 m ³ SAE heaped bucket	★0.52 m ³ SAE heaped bucket

Capacity		Width		Weight	Recommendation				
					5.68 m (18' 8") boom				8.2 m (26' 11") boom
SAE heaped	CECE heaped	Without side cutter	With side cutter		2.0 m arm (6' 7")	2.4 m arm (7' 10")	2.92 m arm (9' 7")	3.90 m arm (12' 10")	6.3 m arm (20' 8")
0.80 m ³ (1.05 yd ³)	0.70 m ³ (0.92 yd ³)	1070 mm (42.1")	1160 mm (45.7")	770 kg (1700 lb)	○	○	○	●	
0.92 m ³ (1.20 yd ³)	0.80 m ³ (1.05 yd ³)	1190 mm (46.9")	1280 mm (50.4")	820 kg (1810 lb)	○	○	○	●	
1.10 m ³ (1.44 yd ³)	0.96 m ³ (1.26 yd ³)	1375 mm (54.1")	1465 mm (57.7")		○	○	⊙	●	
1.20 m ³ (1.57 yd ³)	1.05 m ³ (1.37 yd ³)	1390 mm (54.7")	1480 mm (58.3")		○	⊙	●		
1.34 m ³ (1.75 yd ³)	1.17 m ³ (1.53 yd ³)	1525 mm (60.0")	1615 mm (63.6")		⊙	⊙	●		
★0.52 m ³ (0.68 yd ³)	0.45 m ³ (0.59 yd ³)	945 mm (37.2")	1020 mm (40.2")	460 kg (1010 lb)					⊙

★ : Long reach bucket/Amphibious bucket

○ Applicable for materials with density of 2000 kgf/m³ (3370 lbf/yd³) or less

⊙ Applicable for materials with density of 1600 kgf/m³ (2700 lbf/yd³) or less

● Applicable for materials with density of 1100 kgf/m³ (1850 lbf/yd³) or less

※ These recommendations are for general conditions and average use.

Work tools and ground conditions have effects on machine performance.

Select an optimum combination according to the working conditions and the type of work that is being done.

Consult your Hyundai dealer for information on selecting the correct boom-arm-bucket combination.

2) HEAVY DUTY AND ROCK-HEAVY DUTY BUCKET

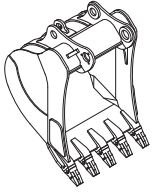
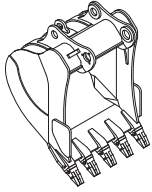
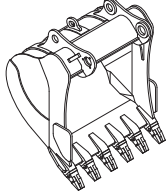
		
◆ 0.90, 1.05 m ³ SAE heaped bucket	◆ 0.87 m ³ SAE heaped bucket	◆ 1.20m ³ SAE heaped bucket

Capacity		Width		Weight	Recommendation			
SAE heaped	CECE heaped	Without side cutter	With side cutter		5.85 m (19' 2") boom			
					2.0 m arm (6' 7")	2.4 m arm (7' 10")	2.92 m arm (9' 7")	3.90 m arm (12' 10")
◆ 0.90 m ³ (1.18 yd ³)	0.79 m ³ (1.03 yd ³)	1210 mm (47.6")	-		○	○	○	●
◆ 1.05 m ³ (1.37 yd ³)	0.92 m ³ (1.20 yd ³)	1355 mm (53.3")	-		○	○	⊙	●
◆ 0.87 m ³ (1.14 yd ³)	0.77 m ³ (1.01 yd ³)	1195 mm (47.0")	-		○	○	○	●
◆ 1.20 m ³ (1.57 yd ³)	1.05 m ³ (1.37 yd ³)	1520 mm (59.8")	-		⊙	●		

◆ : Heavy duty bucket ◆ : Rock-Heavy duty bucket

○ Applicable for materials with density of 2000 kgf/m³ (3370 lbf/yd³) or less

⊙ Applicable for materials with density of 1600 kgf/m³ (2700 lbf/yd³) or less

● Applicable for materials with density of 1100 kgf/m³ (1850 lbf/yd³) or less

7. UNDERCARRIAGE

1) TRACKS

X-leg type center frame is integrally welded with reinforced box-section track frames. The design includes dry tracks, lubricated rollers, idlers, sprockets, hydraulic track adjusters with shock absorbing springs and assembled track-type tractor shoes with triple grousers.

2) TYPES OF SHOES

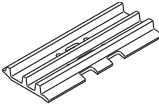
Model	Shapes		Triple grouser			
						
HX220 L	Shoe width	mm (in)	600 (24)	700 (28)	800 (32)	900 (36)
	Operating weight	kg (lb)	22100 (48720)	22570 (49760)	22850 (50380)	23130 (50990)
	Ground pressure	kgf/cm ² (psi)	0.47 (6.68)	0.41 (5.83)	0.37 (5.26)	0.33 (4.69)
	Overall width	mm (ft-in)	2990 (9' 10")	3090 (10' 2")	3190 (10' 6")	3290 (10' 10")
HX220 L LONG REACH	Shoe width	mm (in)	-	-	800 (32)	-
	Operating weight	kg (lb)	-	-	24820 (54720)	-
	Ground pressure	kgf/cm ² (psi)	-	-	0.39 (5.55)	-
	Overall width	mm (ft-in)	-	-	3190 (10' 6")	-
HX220 L HIGH WALKER	Shoe width	mm (in)	600 (24)	700 (28)	800 (32)	710 (28)*
	Operating weight	kg (lb)	23560 (51940)	24030 (52980)	24310 (53590)	24040 (53000)
	Ground pressure	kgf/cm ² (psi)	0.50 (7.11)	0.44 (6.26)	0.39 (5.55)	0.43 (6.11)
	Overall width	mm (ft-in)	3395 (11' 2")	3495 (11' 6")	3595 (11' 10")	3505 (11' 6")

* : Double grouser

3) NUMBER OF ROLLERS AND SHOES ON EACH SIDE

Item	Quantity
Carrier rollers	2 EA
Track rollers	9 EA
Track shoes	49 EA

4) SELECTION OF TRACK SHOE

Suitable track shoes should be selected according to operating conditions.

Method of selecting shoes

Confirm the category from the list of applications in **table 2**, then use **table 1** to select the shoe. Wide shoes (categories B and C) have limitations on applications. Before using wide shoes, check the precautions, then investigate and study the operating conditions to confirm if these shoes are suitable.

Select the narrowest shoe possible to meet the required flotation and ground pressure. Application of wider shoes than recommendations will cause unexpected problem such as bending of shoes, crack of link, breakage of pin, loosening of shoe bolts and the other various problems.

※ **Table 1**

Track shoe	Specification	Category
600 mm triple grouser	Standard	A
700 mm triple grouser	Option	B
710 mm double grouser ★1	Option	B
800 mm triple grouser	Option	C
800 mm triple grouser (long reach)	Standard	C
900 mm triple grouser	Option	C

★1 : HIGH WALKER ONLY

※ **Table 2**

Category	Applications	Precautions
A	Rocky ground, river beds, normal soil	<ul style="list-style-type: none"> Travel at low speed on rough ground with large obstacles such as boulders or fallen trees
B	Normal soil, soft ground	<ul style="list-style-type: none"> These shoes cannot be used on rough ground with large obstacles such as boulders or fallen trees Travel at high speed only on flat ground Travel slowly at low speed if it is impossible to avoid going over obstacles
C	Extremely soft ground (swampy ground)	<ul style="list-style-type: none"> Use the shoes only in the conditions that the machine sinks and it is impossible to use the shoes of category A or B These shoes cannot be used on rough ground with large obstacles such as boulders or fallen trees Travel at high speed only on flat ground Travel slowly at low speed if it is impossible to avoid going over obstacles

8. SPECIFICATIONS FOR MAJOR COMPONENTS

1) ENGINE

Item	Specification
Model	Cummins QSB6.7
Type	4-cycle turbocharged, charger air cooled diesel engine
Cooling method	Water cooling
Number of cylinders and arrangement	6 cylinders, in-line
Firing order	1-5-3-6-2-4
Combustion chamber type	Direct injection type
Cylinder bore × stroke	107 × 124 mm (4.2" × 4.9")
Piston displacement	6700 cc (409cu in)
Compression ratio	17.3 : 1
Rated net horse power (SAE J1349)	173 Hp at 1950 rpm (129 kW at 1950 rpm)
Rated gross horse power (SAE J1995)	182.6 Hp at 1950 rpm (136 kW at 1950 rpm)
Maximum torque at 1500 rpm	81.6 kgf · m (590 lbf · ft)
Engine oil quantity	23.1 l (6.1 U.S. gal)
Wet weight	520 kg (1146 lb)
High idling speed	1900 ± 50 rpm
Low idling speed	850 ± 100 rpm
Rated fuel consumption	158.5 g/Hp · hr at 1950 rpm
Starting motor	Nippon denso (24 V-4.8 kW)
Alternator	Delco Remy (24 V-95 A)
Battery	2 × 12 V × 100 Ah

2) MAIN PUMP

Item	Specification
Type	Variable displacement tandem axis piston pumps
Capacity	2 × 117cc/rev
Maximum pressure	350kgf/cm ² (4980psi) [380 kgf/cm ² (5400 psi)]
Rated oil flow	2 × 222 l /min (58.6U.S. gpm/ 48.8U.K. gpm)
Rated speed	1900 rpm

[] : Power boost

3) GEAR PUMP

Item	Specification
Type	Fixed displacement gear pump single stage
Capacity	15 cc/rev
Maximum pressure	40 kgf/cm ² (570 psi)
Rated oil flow	28.5 l /min (7.5 U.S. gpm/6.3 U.K. gpm)

4) MAIN CONTROL VALVE

Item	Specification	
	HX220 L	HX220 L Long reach
Type	9 spools two-block	
Operating method	Hydraulic pilot system	
Main relief valve pressure	350 kgf/cm ² (4980 psi) [380 kgf/cm ² (5400 psi)]	
Port relief valve pressure	Boom	400 kgf/cm ² (5690 psi)
	Arm	400 kgf/cm ² (5690 psi) 300 kgf/cm ² (4270 psi)
	Bucket	400 kgf/cm ² (5690 psi) 280 kgf/cm ² (3980 psi)

[]: Power boost

5) SWING MOTOR

Item	Specification
Type	Two fixed displacement axial piston motor
Capacity	142.8 cc/rev
Relief pressure	265 kgf/cm ² (3770 psi)
Braking system	Automatic, spring applied hydraulic released
Braking torque	58 kgf/cm ² (420 psi)
Brake release pressure	21.3~35.6 kgf · m (154~257 lbf · ft)
Reduction gear type	2 - stage planetary

6) TRAVEL MOTOR

Item	Specification
Type	Variable displacement axial piston motor
Relief pressure	350 kgf/cm ² (4980 psi)
Reduction gear type	2-stage planetary
Braking system	Automatic, spring applied hydraulic released
Brake release pressure	15.2 kgf/cm ² (216 psi)
Braking torque	65.4 kgf · m (473 lbf · ft)

7) REMOTE CONTROL VALVE

Item		Specification
Type		Pressure reducing type
Operating pressure	Minimum	6.5 kgf/cm ² (92 psi)
	Maximum	25 kgf/cm ² (356 psi)
Single operation stroke	Lever	90 mm (3.5 in)
	Pedal	130 mm (4.4 in)

8) CYLINDER

Item		Specification
Boom cylinder	Bore dia × Rod dia × Stroke	∅ 120 × ∅ 85 × 1290 mm
	Cushion	Extend only
Arm cylinder	Bore dia × Rod dia × Stroke	∅ 140 × ∅ 100 × 1510 mm # ∅ 140 × ∅ 100 × 1460 mm
	Cushion	Extend and retract
Bucket cylinder	Bore dia × Rod dia × Stroke	∅ 120 × ∅ 85 × 1055 mm # ∅ 100 × ∅ 70 × 870 mm
	Cushion	Extend only

※ Discoloration of cylinder rod can occur when the friction reduction additive of lubrication oil spreads on the rod surface.

※ Discoloration does not cause any harmful effect on the cylinder performance.

: LONG REACH

9) SHOE

Item		Width	Ground pressure	Link quantity	Overall width
HX220 L	Standard	600 mm (24")	0.47 kgf/cm ² (6.68 psi)	49	2990 mm (9' 10")
	Option	700 mm (28")	0.41 kgf/cm ² (5.83 psi)	49	3090 mm (10' 2")
		800 mm (32")	0.37 kgf/cm ² (5.26 psi)	49	3190 mm (10' 6")
		900 mm (36")	0.33 kgf/cm ² (4.69 psi)	49	3290 mm (10' 10")
HX220 L LONG REACH	Standard	800 mm (32")	0.39 kgf/cm ² (5.55 psi)	49	3190 mm (10' 6")
HX220 L HIGH WALKER	Standard	600 mm (24")	0.50 kgf/cm ² (7.11 psi)	49	3395 mm (11' 2")
	Option	700 mm (28")	0.44 kgf/cm ² (6.26 psi)	49	3495 mm (11' 6")
		800 mm (32")	0.39 kgf/cm ² (5.55 psi)	49	3595 mm (11' 10")
		※ 710 mm (28")	0.43 kgf/cm ² (6.11 psi)	49	3505 mm (11' 6")

※ : Double grouser

10) BUCKET

Item	Capacity		Tooth quantity	Width	
	SAE heaped	CECE heaped		Without side cutter	With side cutter
HX220 L	0.80 m ³ (1.05 yd ³)	0.70 m ³ (0.92 yd ³)	5	1070 mm (42.1")	1160 mm (45.7")
	0.92 m ³ (1.20 yd ³)	0.80 m ³ (1.05 yd ³)	5	1190 mm (46.9")	1280 mm (50.4")
	1.10 m ³ (1.44 yd ³)	0.96 m ³ (1.26 yd ³)	5	1375 mm (54.1")	1465 mm (57.7")
	1.20 m ³ (1.57 yd ³)	1.05 m ³ (1.37 yd ³)	5	1390 mm (54.7")	1480 mm (58.3")
	1.34 m ³ (1.75 yd ³)	1.17 m ³ (1.53 yd ³)	6	1525 mm (60.0")	1615 mm (63.6")
	★0.52 m ³ (0.68 yd ³)	0.45 m ³ (0.59 yd ³)	5	945 mm (37.2")	1020 mm (40.2")
	◆0.90 m ³ (1.18 yd ³)	0.79 m ³ (1.03 yd ³)	5	1210 mm (47.6")	-
	◆1.05 m ³ (1.37 yd ³)	0.92 m ³ (1.20 yd ³)	5	1355 mm (53.3")	-
	◎0.87 m ³ (1.14 yd ³)	0.77 m ³ (1.01 yd ³)	5	1195 mm (47.0")	-
	◎1.20 m ³ (1.57 yd ³)	1.05 m ³ (1.37 yd ³)	6	1520 mm (59.8")	-

★ : Long reach bucket

◆ : Heavy duty bucket

◎ : Rock-heavy duty bucket

9. RECOMMENDED OILS

HYUNDAI genuine lubricating oils have been developed to offer the best performance and service life for your equipment. These oils have been tested according to the specifications of HYUNDAI and, therefore, will meet the highest safety and quality requirements.

We recommend that you use only HYUNDAI genuine lubricating oils and grease officially approved by HYUNDAI.

Service point	Kind of fluid	Capacity ℓ (U.S. gal)	Ambient temperature °C(°F)									
			-50 (-58)	-30 (-22)	-20 (-4)	-10 (14)	0 (32)	10 (50)	20 (68)	30 (86)	40 (104)	
Engine oil pan	Engine oil	24.4 (6.4)	★SAE 5W-40									
							SAE 30					
						SAE 10W						
							SAE 10W-30					
						SAE 15W-40						
DEF/ AdBlue® tank	Mixture of urea and deionized water	27.0 (7.1)	ISO 22241, High-purity urea + deionized water (32.5:67.5)									
Swing drive	Gear oil	6.2 (1.2)	★SAE 75W-90									
Final drive		4.5×2 (1.2×2)					SAE 80W-90					
Hydraulic tank	Hydraulic oil	Tank : 160 (42.3) System : 275★ (72.6)	★ISO VG 15									
						ISO VG 32						
							ISO VG 46, HBHO VG 46★ ³					
						ISO VG 68						
Fuel tank	Diesel fuel★ ¹	400 (106)	★ASTM D975 NO.1									
							ASTM D975 NO.2					
Fitting (grease nipple)	Grease	As required	★NLGI NO.1									
							NLGI NO.2					
Radiator (reservoir tank)	Mixture of antifreeze and soft water★ ²	40 (10.6)	Ethylene glycol base permanent type (50 : 50)									
						★Ethylene glycol base permanent type (60 : 40)						

SAE : Society of Automotive Engineers

API : American Petroleum Institute

ISO : International Organization for Standardization

NLGI : National Lubricating Grease Institute

ASTM : American Society of Testing and Material

UTTO : Universal Tractor Transmission Oil

DEF : Diesel Exhaust Fluid, DEF compatible with AdBlue®

★ : Cold region

Russia, CIS, Mongolia

★¹ : Ultra low sulfur diesel
- sulfur content ≤ 15 ppm

★² : Soft water
City water or distilled water

★³ : Hyundai Bio Hydraulic Oil

- For more information, contact HYUNDAI dealers.

※ Using any lubricating oils other than HYUNDAI genuine products may lead to a deterioration of performance and cause damage to major components.

※ Do not mix HYUNDAI genuine oil with any other lubricating oil as it may result in damage to the systems of major components.

※ Do not use any engine oil other than that specified above, as it may clog the diesel particulate filter(DPF).

※ For HYUNDAI genuine lubricating oils and grease for use in regions with extremely low temperatures, please contact HYUNDAI dealers.