

SECTION 5 MECHATRONICS SYSTEM

Group 1 Outline	5-1
Group 2 Mode Selection System	5-3
Group 3 Automatic Deceleration System	5-6
Group 4 Power Boost System	5-7
Group 5 Travel Speed Control System	5-8
Group 6 Automatic Warming Up System	5-9
Group 7 Engine Overheat Prevention System	5-10
Group 8 Variable Power Control System	5-11
Group 9 Attachment Flow Control System	5-12
Group 10 Intelligent Power Control System.....	5-13
Group 11 Anti-Restart System	5-15
Group 12 Self-Diagnostic System	5-16
Group 13 Engine Control System	5-61
Group 14 EPPR Valve	5-62
Group 15 Monitoring System	5-67
Group 16 Fuel Warmer System	5-109
Group 17 1 or 2-Way Optional Piping Pressure Removal System	5-110

GROUP 1 OUTLINE

The ADVANCED CAPO (Computer Aided Power Optimization) system controls engine and pump mutual power at an optimum and less fuel consuming state for the selected work by mode selection, auto-deceleration, power boost function, etc. It monitors machine conditions, for instance, engine speed, coolant temperature, hydraulic oil temperature, and hydraulic oil pressure, etc. It consists of a MCU, a cluster, an ECM, EPPR valves, and other components. The MCU and the cluster protect themselves from over-current and high voltage input, and diagnose malfunctions caused by short or open circuit in electric system, and display error codes on the cluster.

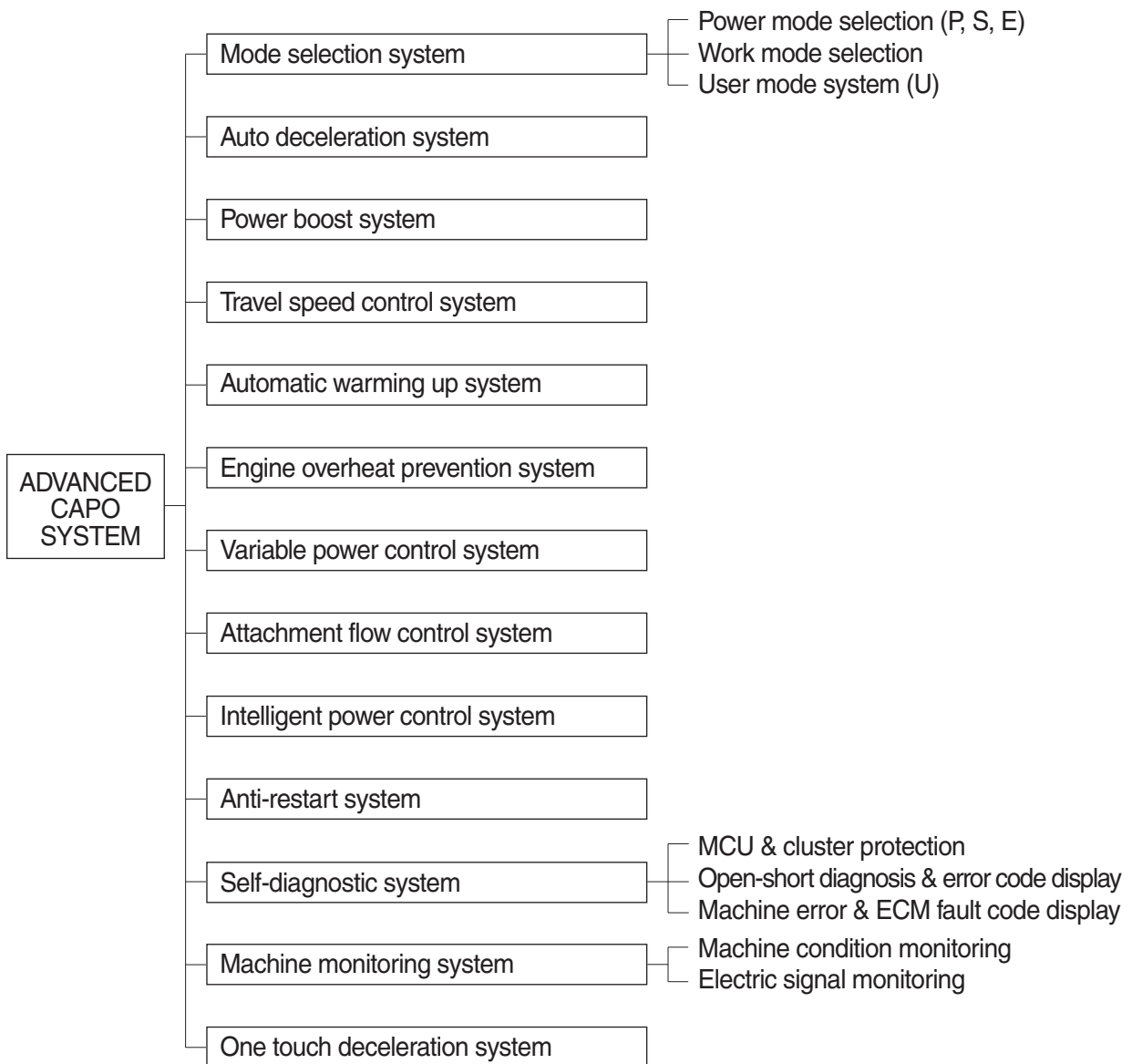

SYSTEM DIAGRAM

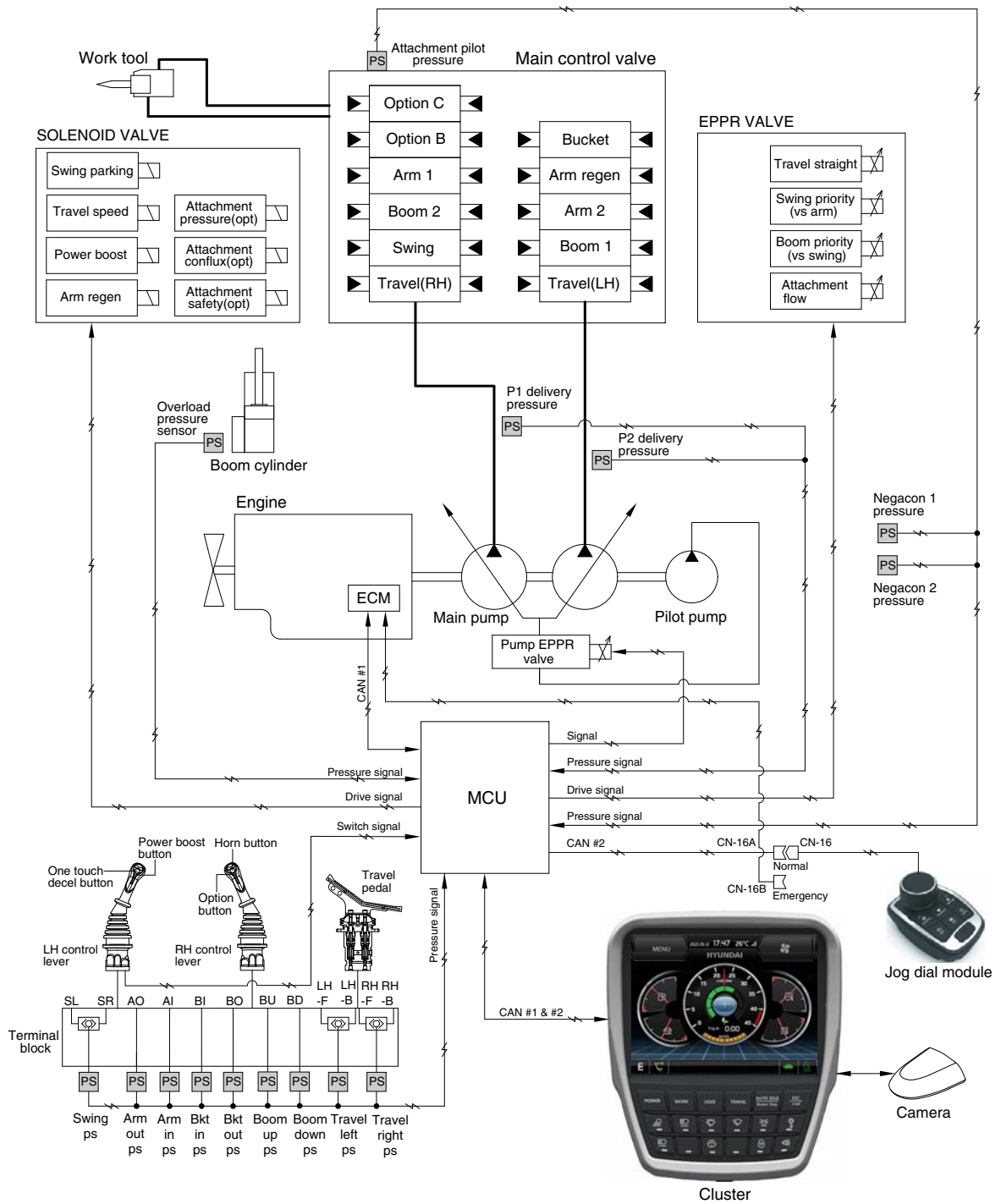

140A5MS01

GROUP 2 MODE SELECTION SYSTEM

1. POWER MODE SELECTION SYSTEM

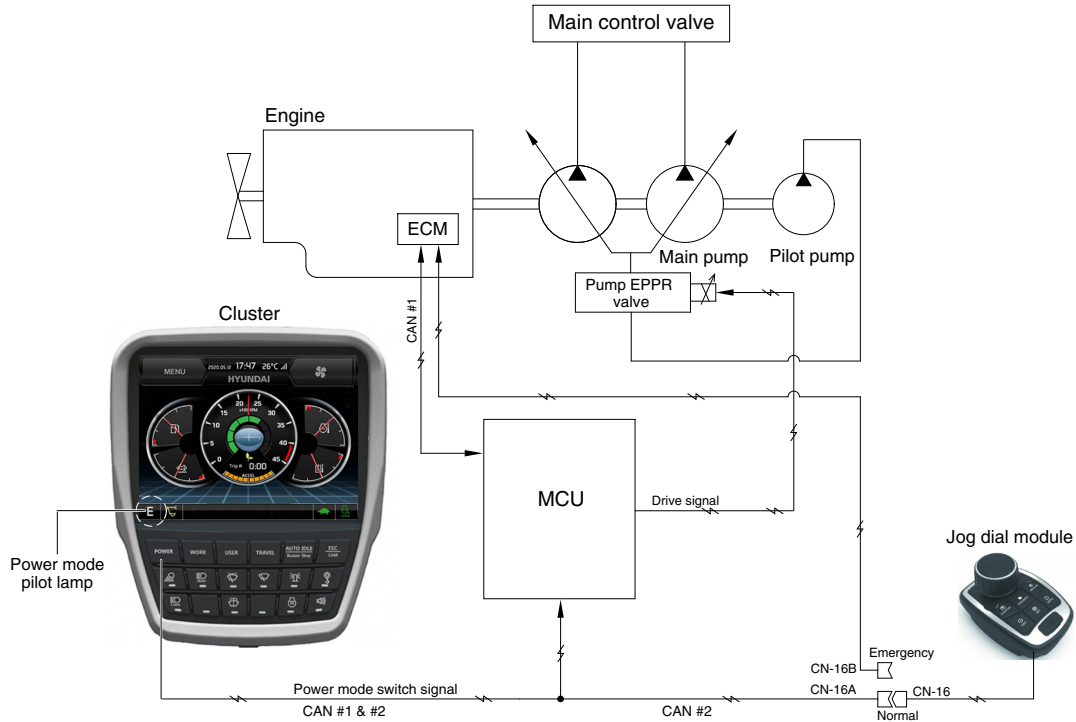

160A5MS02

Mode selection system (micro computer based electro-hydraulic pump and engine mutual control system) optimizes the engine and pump performance.

The combination of 3 power modes (P, S, E) and acceleration mode (10 set) of jog dial module makes it possible to use the engine and pump power more effectively corresponding to the work conditions from a heavy and great power requesting work to a light and precise work.

Power mode	Application	Engine rpm				Pump EPPR (kg/cm ²)			
		Standard		Option		Standard		Option	
		No load	Load	No load	Load	No load	Load	No load	Load
P	Heavy duty power	1850	1950	1950	1950	17	10	15	8
S	Standard power	1750	1850	1850	1850	20	13	17	10
E	Economy operation	1650	1750	1750	1750	22	15	19	12
Auto decel	Engine deceleration	1200 ± 50	-	1200 ± 50	-	38	38	38	38
One touch decel	Engine quick deceleration	1100 ± 50	-	1100 ± 50	-	38	38	38	38
Key start	Key switch start position	1000 ± 50	-	1000 ± 50	-	38	38	38	38

- ※ Power shift (Standard/Option) can be changed by "Service menu" in "Management" on the cluster.
- ※ In work modes, engine speed stays at 1000 rpm if the safety knob is at "LOCK" position. (Low idle goes to 1100 rpm if "UNLOCK")
- ※ Auto decel, one touch decel and low idle speed may increase to 1350 rpm while automatic exhaust system cleaning is being performed.

2. WORK MODE SELECTION SYSTEM

Work mode consists of the general operation (bucket) and the optional attachment (breaker, crusher).

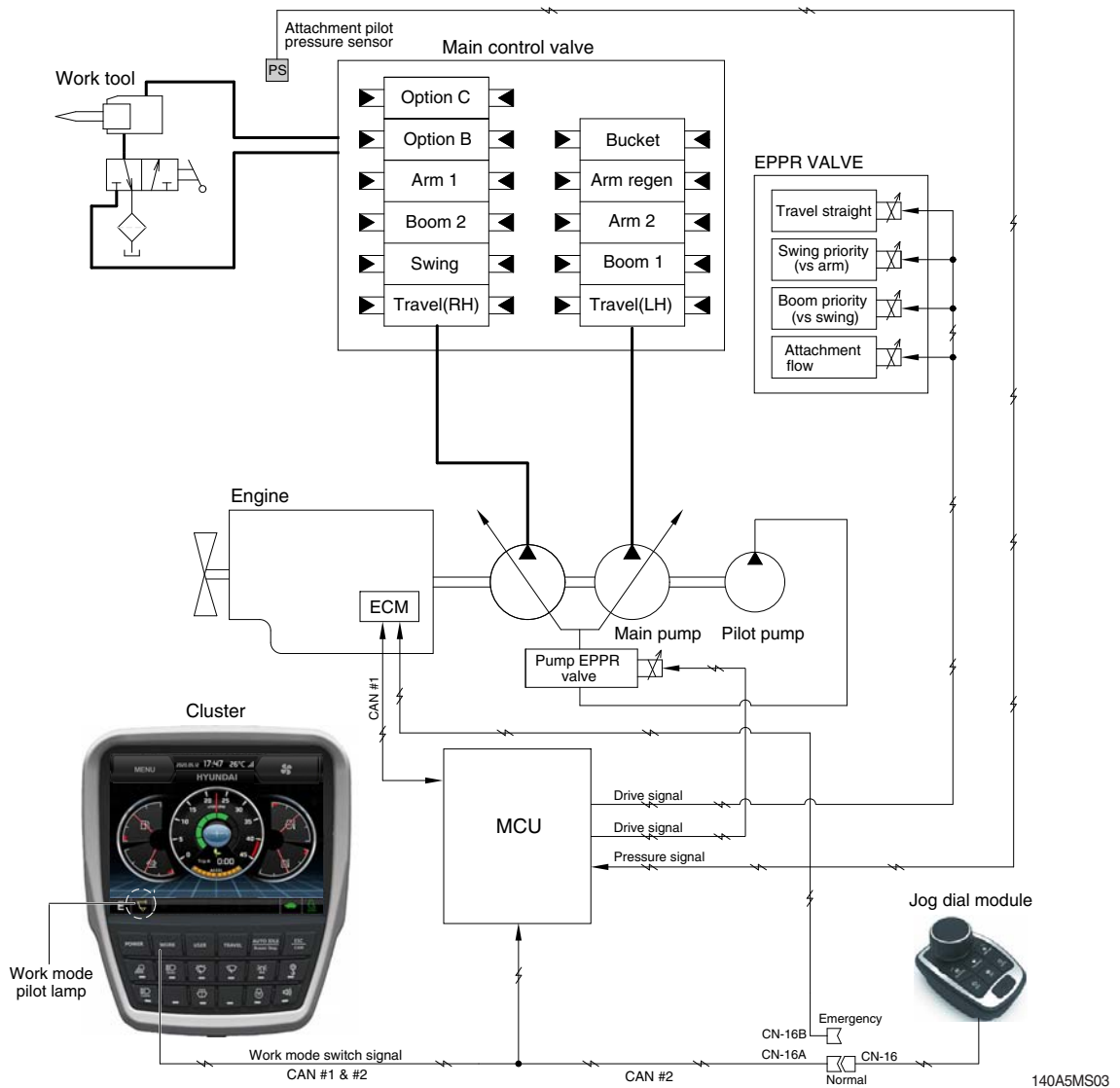

1) GENERAL WORK MODE (bucket)

This mode is used to general digging work.

2) ATT WORK MODE (breaker, crusher)

It controls the pump flow and system pressure according to the operation of breaker or crusher.

Description	General mode	Work tool	
	Bucket	Breaker	Crusher
Attachment safety solenoid	OFF	-	ON
Attachment conflux solenoid	OFF	ON/OFF	ON/OFF
Attachment flow EPPR current	100 mA	100~700 mA	100~700 mA
Breaker solenoid★	OFF	ON	-

★ When breaker operating button is pushed.

3. USER MODE SELECTION SYSTEM

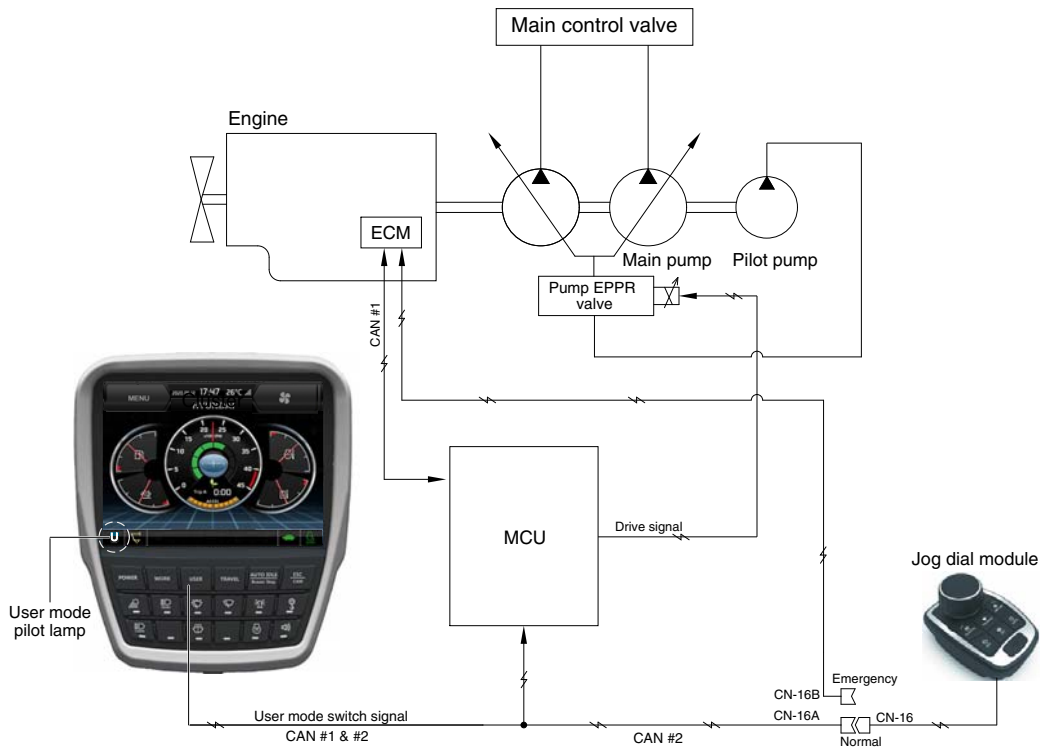

160A5MS04

1) High idle rpm, auto idle rpm and EPPR pressure can be adjusted and memorized in the U-mode.

2) LCD segment vs parameter setting

Step ()	Engine speed (rpm)	Idle speed (rpm)
1	1300	750
2	1400	800
3	1500	850
4	1600	900
5	1700	950
6	1800	1000
7	1850	1050
8	1900	1100
9	1950	1150
10	2000	1200 (auto decel)

GROUP 3 AUTOMATIC DECELERATION SYSTEM

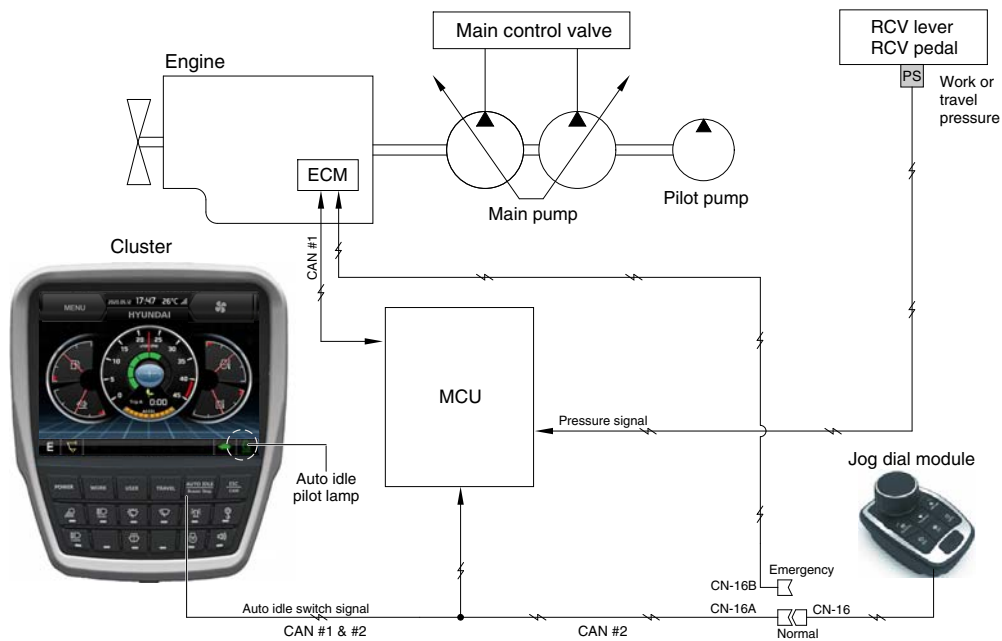

210A5MS05

1. WHEN AUTO IDLE PILOT LAMP ON

When all of the work equipment control levers including swing and travel levers are at neutral for 4 seconds, MCU sends throttle command to ECM to reduce the engine speed to 1200 rpm. If the control levers are at neutral for 1 minute, MCU reduces the engine speed to 1100 rpm. As the result of reducing the engine speed, fuel consumption and noise are effectively cut down during non-operation of the control levers.

When the Auto idle pilot lamp is turned off by pressing the switch or any control lever is operated, the reduced engine speed rises upto the speed before deceleration in a second.

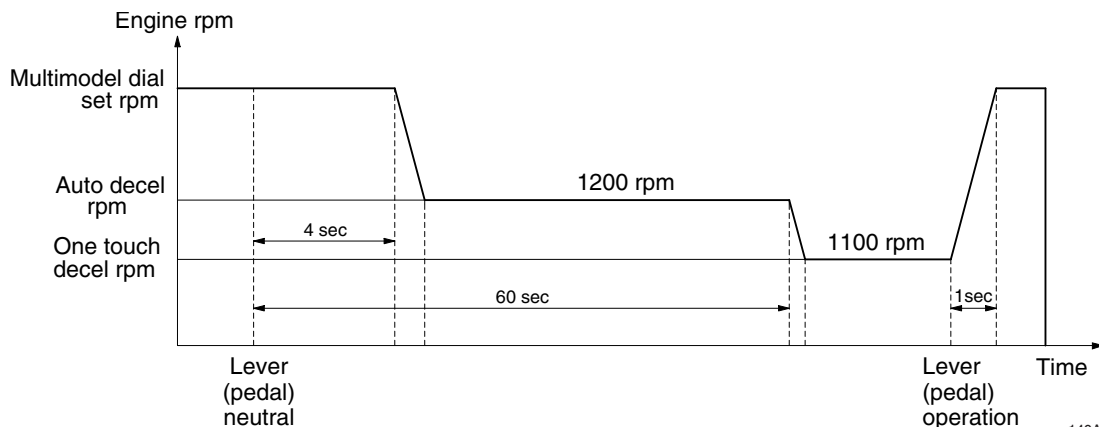

140A5MS105

2. WHEN AUTO IDLE PILOT LAMP OFF

The engine speed can be set as desired using the multimodal dial switch, and even if the control levers are neutral, the engine speed is not reduced.

※ Auto idle function can be activated when multimodal dial position is over 4.

GROUP 4 POWER BOOST SYSTEM

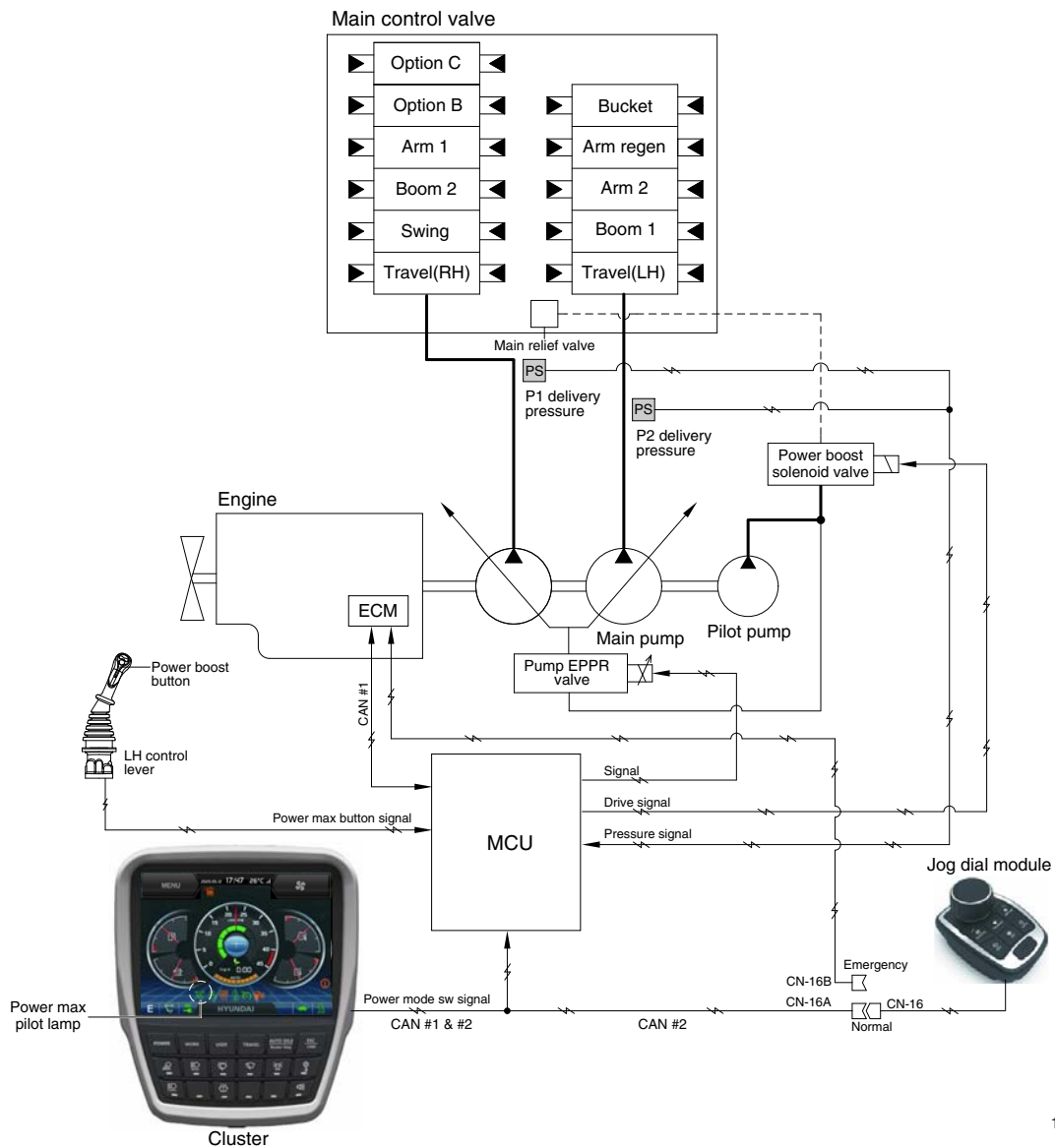

160A5MS06

- When the power boost switch on the left control lever knob is pushed ON, the power mode is set P mode and maximum digging power is increased by 10 %.
- When the power boost function is activated, the power boost solenoid valve pilot pressure raises the set pressure of the main relief valve to increase the digging power.

Description	Condition	Function
Activated	Power boost switch : ON Multimodal dial : over 8	- Power mode : P - Multimodal dial power : 9 - Power boost solenoid : ON - Power boost pilot lamp : ON - Operating time : max 8 seconds
Canceled	Power boost switch : OFF	- Pre-set power mode - Power boost solenoid : OFF - Power boost pilot lamp : OFF

- ※ When the auto power boost is set to Enable and power mode is set to P mode on the cluster, the digging power is automatically increased as working conditions by the MCU. It is operated max 8 seconds.

GROUP 5 TRAVEL SPEED CONTROL SYSTEM

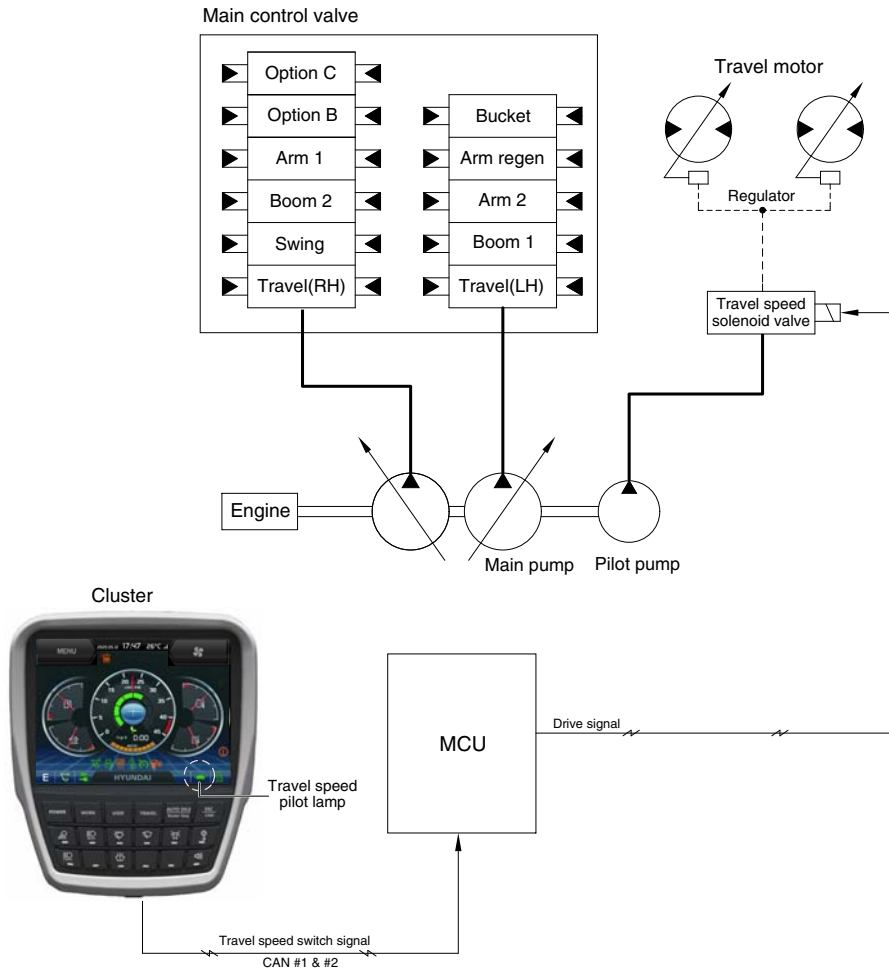

160A5MS07

Travel speed can be switched manually by pressing the travel speed switch on the cluster.

Speed	Travel speed solenoid valve	Lamp on cluster	Operation
Low	OFF	Turtle	Low speed, high driving torque in the travel motor
High	ON	Rabbit	High speed, low driving torque in the travel motor

※ Default : Turtle (Low)

GROUP 6 AUTOMATIC WARMING UP SYSTEM

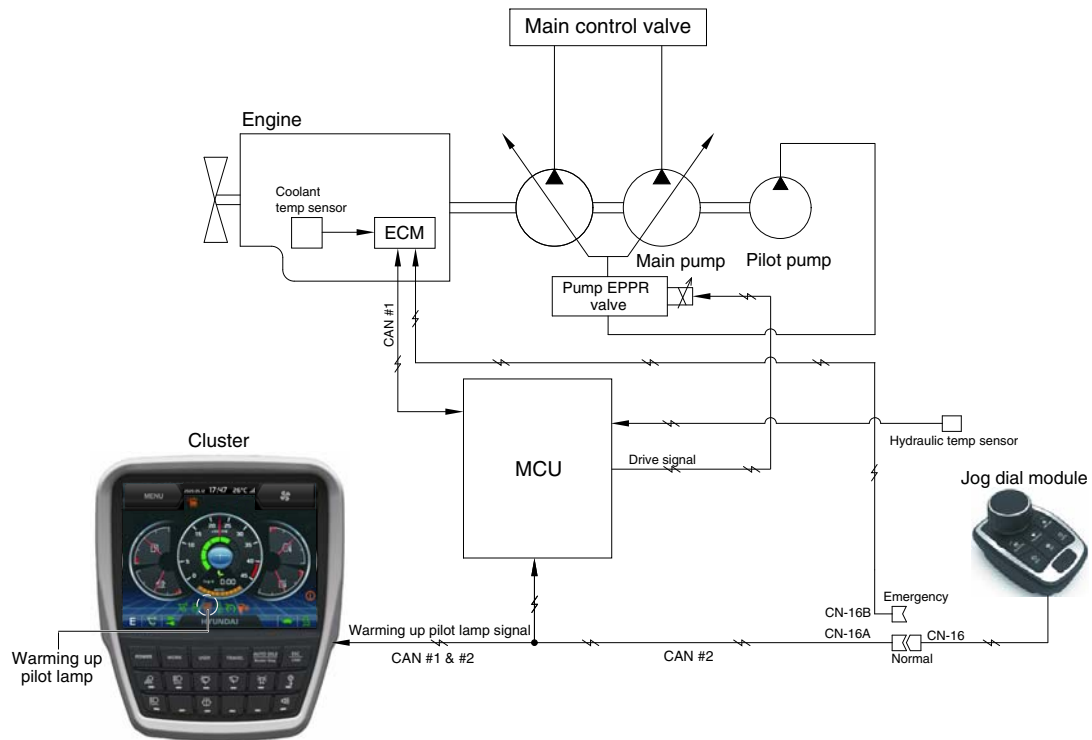

160A5MS08

1. The MCU receives the engine coolant temperature from the ECM, and if the coolant temperature is below 30°C, it increases the engine speed from key start rpm to 1200 rpm. At this time the mode does not change. If the coolant temperature sensor has fault, the hydraulic oil temperature signal is substituted.
2. In case of the coolant temperature increases up to 30°C, the engine speed is decreased to key start speed. And if an operator changes power mode set during the warming up function, the MCU cancels the automatic warming up function.

3. LOGIC TABLE

Description	Condition	Function
Actuated	- Coolant temperature : below 30°C (after engine run)	- Power mode : Default (E mode) - Warming up time : 10 minutes (max) - Warming up pilot lamp : ON
Canceled	- Coolant temperature : Above 30°C - Warming up time : Above 10 minutes - Changed power mode set by operator - RCV lever or pedal operating - Auto idle cancel ※ If any of the above conditions is applicable, the automatic warming up function is canceled	- Power mode : set mode - Warming up pilot lamp : OFF

GROUP 7 ENGINE OVERHEAT PREVENTION SYSTEM

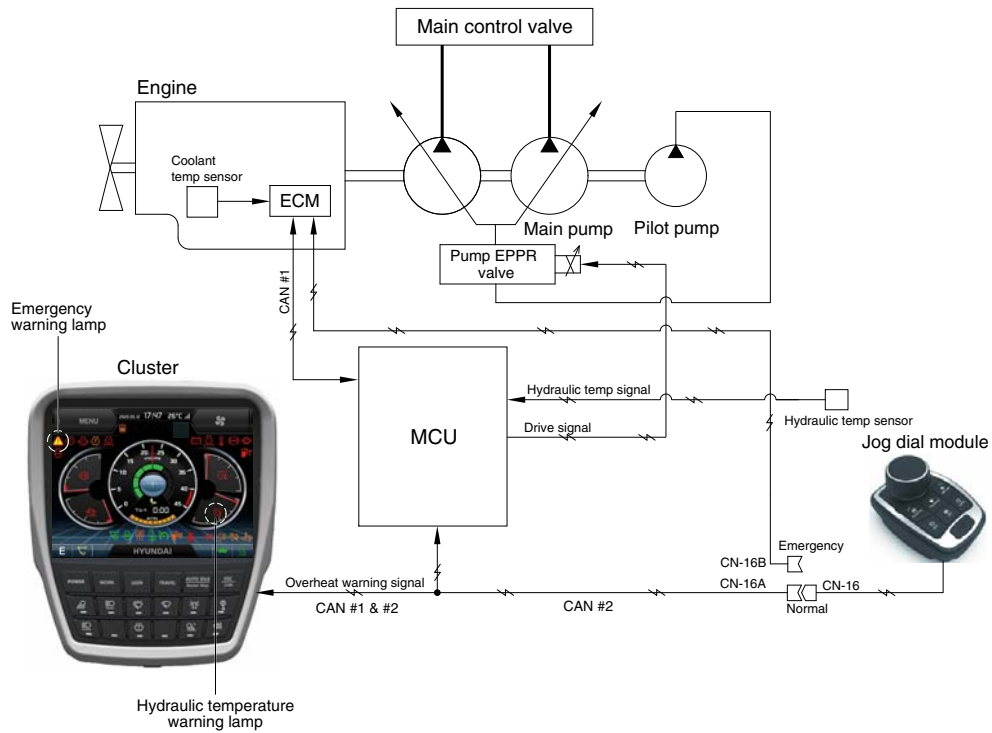

160A5MS09

1. If the engine coolant temperature is overheated over 103°C or the hydraulic oil temperature is overheated over 100°C, the warning lamp is ON and the pump input torque or the engine speed is reduced as below logic table.

2. LOGIC TABLE

Description		Condition	Function
First step warning	Activated	- Coolant temperature : Above 103°C - Hydraulic oil temperature : Above 100°C	- Warning lamp : ON , buzzer : OFF - Pump input torque is reduced.
	Canceled	- Coolant temperature : Less than 100°C - Hydraulic oil temperature : Less than 95°C	- Return to pre-set the pump absorption torque.
Second step warning	Activated	- Coolant temperature : Above 107°C - Hydraulic oil temperature : Above 105°C	- Emergency warning lamp pops up on the center of LCD and the buzzer sounds. - Engine speed is reduced after 10 seconds.
	Canceled	- Coolant temperature : Less than 103°C - Hydraulic oil temperature : Less than 100°C	- Return to pre-set the engine speed. - Hold pump absorption torque on the first step warning.

GROUP 8 VARIABLE POWER CONTROL SYSTEM

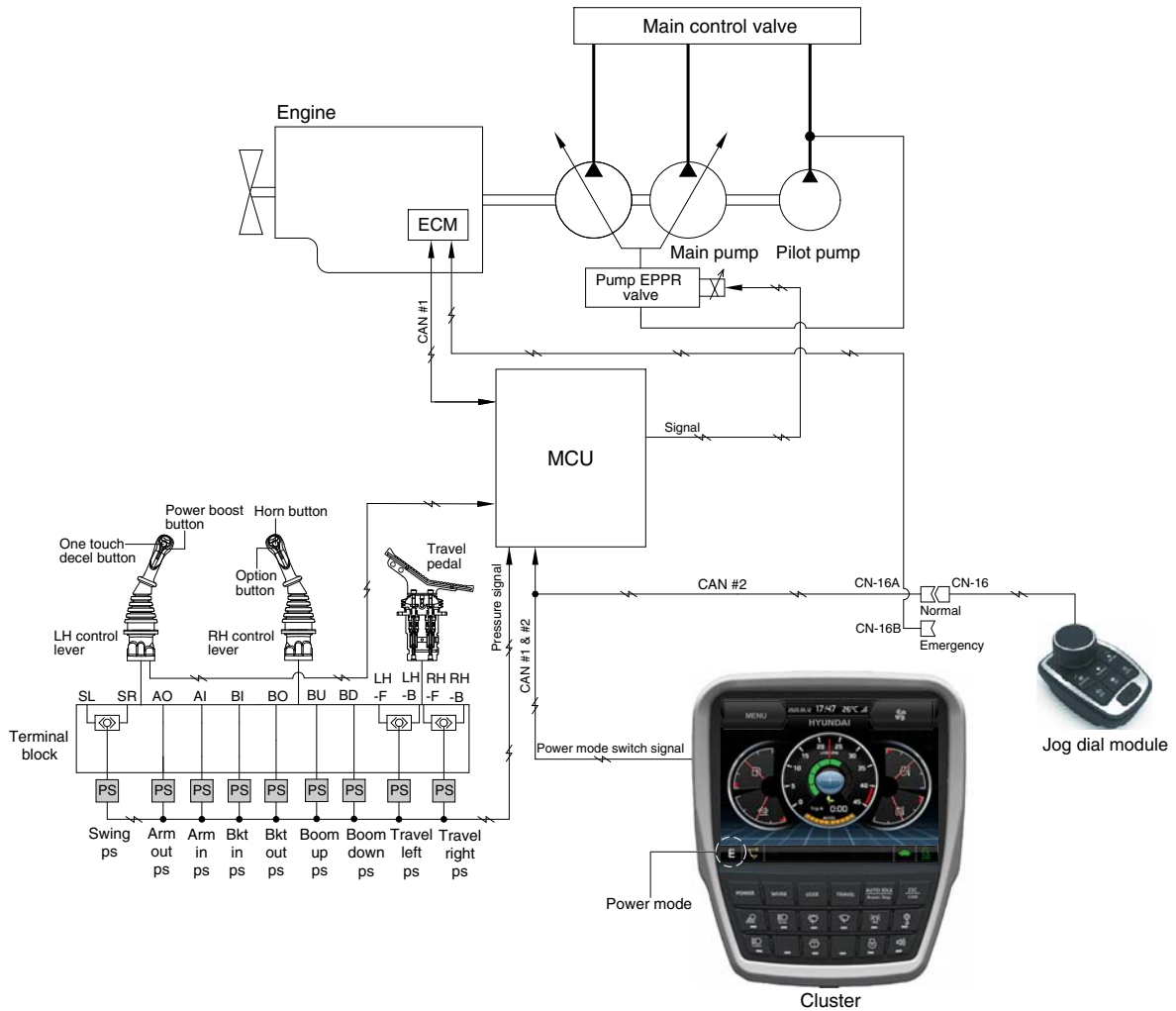

160A5MS10

- The variable power control system controls the engine and pump mutual power according to RCV lever stroke and pump load. It makes fuel saving and smooth control at precise work.

Description	Working condition
Power mode	P, S, E
Work mode	General (bucket)
Pressure sensor	Normal

※ The variable power control function can be activated when the power mode is set to all power mode.

GROUP 9 ATTACHMENT FLOW CONTROL SYSTEM

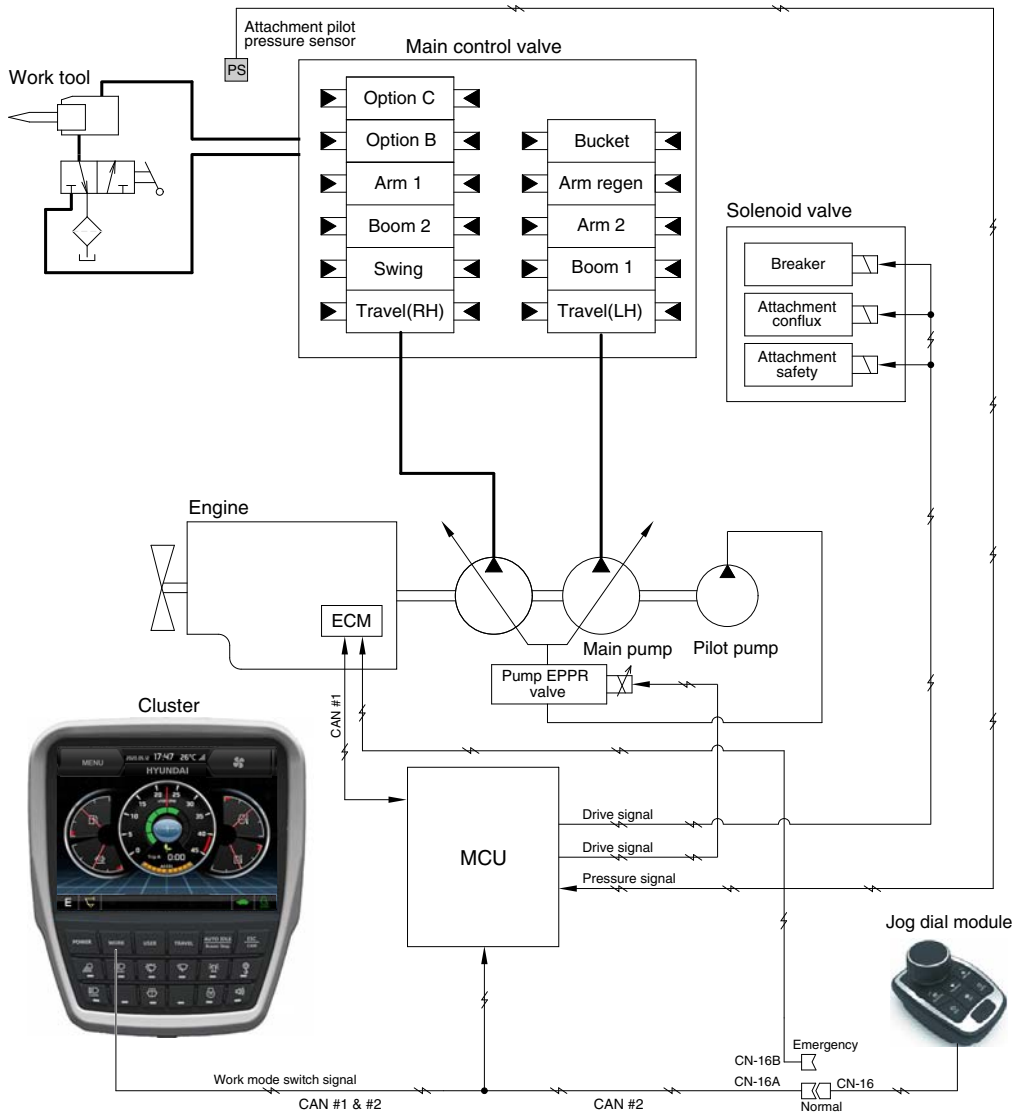

160A5MS11

- The system is used to control the pump delivery flow according to set of the work tool on the cluster by the attachment flow EPPR valve.

Description	Work tool	
	Breaker	Crusher
Flow level	100 ~ 180 lpm	100 ~ 440 lpm
Attach safety solenoid	-	ON
Attach conflux solenoid	ON/OFF	ON/OFF
Breaker solenoid★	ON	-

※ Refer to the page 5-90 for the attachment kinds and max flow.

★ When breaker operating button is pushed.

GROUP 10 INTELLIGENT POWER CONTROL SYSTEM

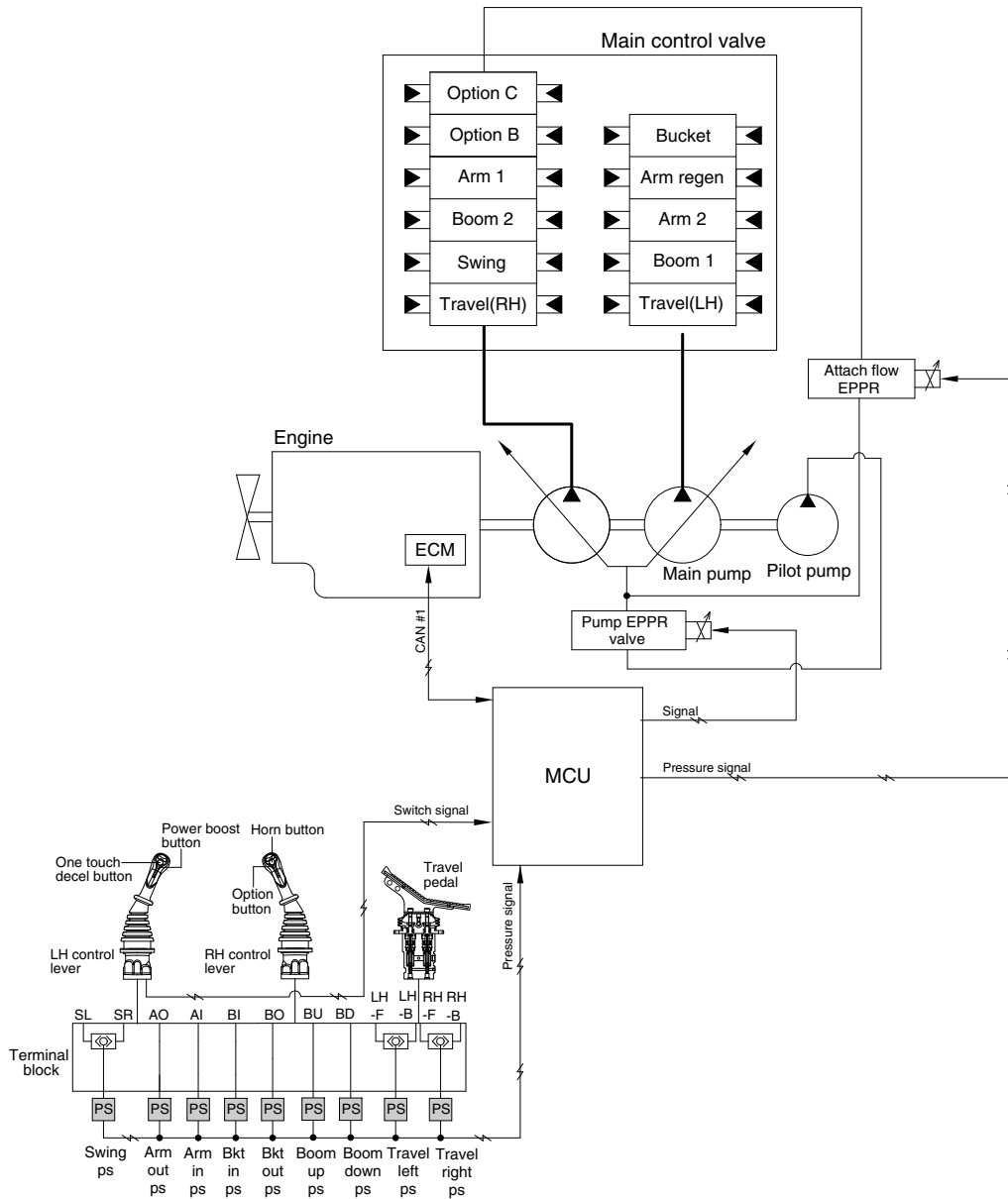

160A5MS18

1. When the requirement of pump flow rate is low, IPC mode controls pump flow rate to improve fuel efficiency.

Condition*1	Function
IPC mode : ON*2 Boom up Arm in Not travel motion Not swing motion	Limitation of pump flow rate : Activated
None of upper condition	Limitation of pump flow rate : Canceled

*1 AND condition

*2 IPC mode ON/OFF is selected at "Mode setup > IPC mode". See next page.

2. IPC MODE SELECTION

IPC mode ON/OFF and the levels of flow rate limit can be selected at "Mode setup > IPC mode"



300A3CD52A

IPC mode	Description
Balance mode (default)	IPC mode ON, limit level 1
Efficiency mode	IPC mode ON, limit level 2
Speed mode	IPC mode OFF

GROUP 11 ANTI-RESTART SYSTEM

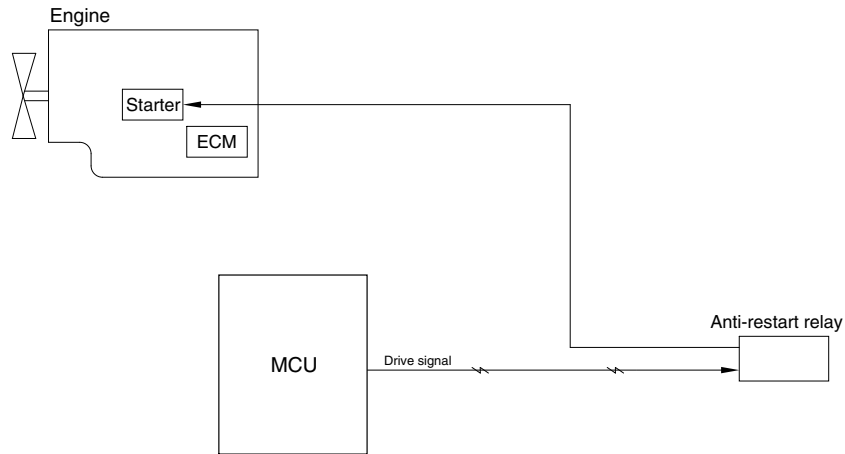

220A5MS12

1. ANTI-RESTART FUNCTION

After a few seconds from the engine starts to run, MCU turns off the anti-restart relay to protect the starter from inadvertent restarting.

GROUP 12 SELF-DIAGNOSTIC SYSTEM

1. OUTLINE

When any abnormality occurs in the ADVANCED CAPO system caused by electric parts malfunction and by open or short circuit, the MCU diagnoses the problem and sends the error codes to the cluster and also stores them in the memory.

2. MONITORING

1) Active fault



- The active faults of the MCU, engine ECM, FATC and AAVM (option) can be checked by this menu.

2) Logged fault



- The logged faults of the MCU, engine ECM, FATC and AAVM (option) can be checked by this menu.

3) Delete logged fault



- The logged faults of the MCU, engine ECM, FATC and AAVM (option) can be deleted by this menu.

3. MACHINE ERROR CODES TABLE

DTC		Diagnostic Criteria	Application		
HCESPN	FMI		G	C	W
101	3	10 seconds continuous, Hydraulic Oil Temp. Measurement Voltage > 3.8V	●		
	4	10 seconds continuous, Hydraulic Oil Temp. Measurement Voltage < 0.3V	●		
	(Results / Symptoms) 1. Monitor – Hydraulic oil temperature display failure 2. Control Function – Fan revolutions control failure (Checking list) 1. CD-1 (#2) - CN-51 (#16) Checking Open/Short 2. CD-1 (#1) - CN-51 (#24) Checking Open/Short				
105	0	10 seconds continuous, Working Press. Sensor Measurement Voltage > 5.2V	●		
	1	10 seconds continuous, $0.3V \leq$ Working Press. Sensor Measurement Voltage < 0.8V	●		
	4	10 seconds continuous, Working Press. Sensor Measurement Voltage < 0.3V	●		
	(Results / Symptoms) 1. Monitor – Working Press. display failure 2. Control Function – Auto Idle operation failure, Engine variable horse power control operation failure (Checking list) 1. CD-7 (#B) – CN-52 (#19) Checking Open/Short 2. CD-7 (#A) – CN-51 (#32) Checking Open/Short 3. CD-7 (#C) – CN-51 (#31) Checking Open/Short				
108	0	10 seconds continuous, Travel Oil Press. Sensor Measurement Voltage > 5.2V		●	
	1	10 seconds continuous, $0.3V \leq$ Travel Oil Press. Sensor Measurement Voltage < 0.8V	●		
	4	10 seconds continuous, Travel Oil Press. Sensor Measurement Voltage < 0.3V	●		
	(Results / Symptoms) 1. Monitor – Travel Oil Press. display failure 2. Control Function – Auto Idle operation failure, Engine variable horse power control operation failure, IPC operation failure, Driving alarm operation failure (Checking list) 1. CD-601 or 602 (#B) – CN-52 (#24 or 27) Checking Open/Short 2. CD-601 or 602 (#A) – CN-51 (#32) Checking Open/Short 3. CD-601 or 602 (#C) – CN-51 (#31) Checking Open/Short				

※ Some error codes are not applied to this machine.

G : General

C : Crawler Type

W : Wheel Type

DTC		Diagnostic Criteria	Application		
HCESPN	FMI		G	C	W
120	0	10 seconds continuous, P1 pump delivery pressure sensor Measurement Voltage > 5.2V	●		
	1	10 seconds continuous, 0.3V ≤ P1 pump delivery pressure sensor Measurement Voltage < 0.8V	●		
	4	10 seconds continuous, P1 pump delivery pressure sensor Measurement Voltage < 0.3V	●		
	(Results / Symptoms) 1. Monitor – P1 pump delivery Press. display failure 2. Control Function – Automatic voltage increase operation failure, Overload at compensation control failure (Checking list) 1. CD-42 (#B) – CN-52 (#22) Checking Open/Short 2. CD-42 (#A) – CN-51 (#32) Checking Open/Short 3. CD-42 (#C) – CN-51 (#31) Checking Open/Short				
121	0	10 seconds continuous, P2 pump delivery pressure sensor Measurement Voltage > 5.2V	●		
	1	10 seconds continuous, 0.3V ≤ P2 pump delivery pressure sensor Measurement Voltage < 0.8V	●		
	4	10 seconds continuous, P2 pump delivery pressure sensor Measurement Voltage < 0.3V	●		
	(Results / Symptoms) 1. Monitor – P2 pump delivery Press. display failure 2. Control Function – Automatic voltage increase operation failure, Overload at compensation control failure (Checking list) 1. CD-43 (#B) – CN-51 (#14) Checking Open/Short 2. CD-43 (#A) – CN-51 (#32) Checking Open/Short 3. CD-43 (#C) – CN-51 (#31) Checking Open/Short				
122	1	(when you had conditions mounting pressure sensor) 10 seconds continuous, 0.3V ≤ Overload Press. Sensor Measurement Voltage < 0.8V	●		
	4	(when you had conditions mounting pressure sensor) 10 seconds continuous, Overload Press. Sensor Measurement Voltage < 0.3V	●		
	(Results / Symptoms) 1. Monitor – Overload Press. display failure 2. Control Function – Overload warning alarm failure (Checking list) 1. CD-31 (#B) – CN-52 (#28) Checking Open/Short 2. CD-31 (#A) – CN-51 (#32) Checking Open/Short 3. CD-31 (#C) – CN-51 (#31) Checking Open/Short				

※ Some error codes are not applied to this machine.

G : General

C : Crawler Type

W : Wheel Type

DTC		Diagnostic Criteria	Application		
HCESPN	FMI		G	C	W
123	0	10 seconds continuous, Negative 1 Press. Sensor Measurement Voltage > 5.2V	●		
	1	10 seconds continuous, 0.3V ≤ Negative 1 Press. Sensor Measurement Voltage < 0.8V	●		
	4	10 seconds continuous, Negative 1 Press. Sensor Measurement Voltage < 0.3V	●		
	(Results / Symptoms) 1. Monitor – Negative 1 Press. display failure 2. Control Function – IPC operation failure, Option attachment flow control operation failure (Checking list) 1. CD-70 (#B) – CN-51 (#22) Checking Open/Short 2. CD-70 (#A) – CN-51 (#32) Checking Open/Short 3. CD-70 (#C) – CN-51 (#31) Checking Open/Short				
124	0	10 seconds continuous, Negative 2 Press. Sensor Measurement Voltage > 5.2V	●		
	1	10 seconds continuous, 0.3V ≤ Negative 2 Press. Sensor Measurement Voltage < 0.8V	●		
	4	10 seconds continuous, Negative 2 Press. Sensor Measurement Voltage < 0.3V	●		
	(Results / Symptoms) 1. Monitor – Negative 2 Press. display failure 2. Control Function – Option attachment flow control operation failure (Checking list) 1. CD-71 (#B) – CN-51 (#28) Checking Open/Short 2. CD-71 (#A) – CN-51 (#32) Checking Open/Short 3. CD-71 (#C) – CN-51 (#31) Checking Open/Short				
127	0	10 seconds continuous, Boom Up Pilot Press. Sensor Measurement Voltage > 5.2V	●		
	1	10 seconds continuous, 0.3V ≤ Boom Up Pilot Press. Sensor Measurement Voltage < 0.8V	●		
	4	10 seconds continuous, Boom Up Pilot Press. Sensor Measurement < 0.3V	●		
	(Results / Symptoms) 1. Monitor – Boom Up Pilot Press. display failure 2. Control Function – Engine/Pump variable horse power control operation failure, IPC operation failure, Boom first operation failure (Checking list) 1. CD-32 (#B) – CN-52 (#23) Checking Open/Short 2. CD-32 (#A) – CN-51 (#32) Checking Open/Short 3. CD-32 (#C) – CN-5 1(#31) Checking Open/Short				

※ Some error codes are not applied to this machine.

G : General

C : Crawler Type

W : Wheel Type

DTC		Diagnostic Criteria	Application		
HCESPN	FMI		G	C	W
128	0	(when you had conditions mounting pressure sensor) 10 seconds continuous, Boom Down Pilot Press. Sensor Measurement Voltage > 5.2V	●		
	1	(when you had conditions mounting pressure sensor) 10 seconds continuous, $0.3V \leq$ Boom Down Pilot Press. Sensor Measurement Voltage < 0.8V	●		
	4	(when you had conditions mounting pressure sensor) 10 seconds continuous, Boom Down Pilot Press. Sensor Measurement Voltage < 0.3V	●		
	(Results / Symptoms) 1. Monitor – Boom Down Pilot Press. display failure 2. Control Function – Boom floating operation failure (Checking list) 1. CD-85 (#B) – CN-52 (#31) Checking Open/Short 2. CD-85 (#A) – CN-51 (#32) Checking Open/Short 3. CD-85 (#C) – CN-51 (#31) Checking Open/Short				
129	0	10 seconds continuous, Arm In Pilot Press. Sensor Measurement Voltage > 4.8V	●		
	1	10 seconds continuous, $0.3V \leq$ Arm In Pilot Press. Sensor Measurement Voltage < 0.8V	●		
	4	10 seconds continuous, Arm In Pilot Press. Sensor Measurement Voltage < 0.3V	●		
	(Results / Symptoms) 1. Monitor – Arm In Pilot Press. display failure 2. Control Function – IPC operation failure (Checking list) 1. CD-90 (#B) – CN-51 (#21) Checking Open/Short 2. CD-90 (#A) – CN-51 (#32) Checking Open/Short 3. CD-90 (#C) – CN-51 (#31) Checking Open/Short				
133	0	10 seconds continuous, Arm Out Pilot Press. Sensor Measurement Voltage > 5.2V	●		
	1	10 seconds continuous, $0.3V \leq$ Arm Out Pilot Press. Sensor Measurement Voltage < 0.8V	●		
	4	10 seconds continuous, Arm Out Pilot Press. Sensor Measurement Voltage < 0.3V	●		
	(Results / Symptoms) 1. Monitor – Arm Out Pilot Press. display failure 2. Control Function – Engine variable horse power control operation failure (Checking list) 1. CD-35 (#B) – CN-51 (#27) Checking Open/Short 2. CD-35 (#A) – CN-51 (#32) Checking Open/Short 3. CD-35 (#C) – CN-51 (#31) Checking Open/Short				

※ Some error codes are not applied to this machine.

G : General

C : Crawler Type

W : Wheel Type

DTC		Diagnostic Criteria	Application		
HCESPN	FMI		G	C	W
135	0	10 seconds continuous, Swing Pilot Press. Sensor Measurement Voltage > 5.2V	●		
	1	10 seconds continuous, 0.3V ≤ Swing Pilot Press. Sensor Measurement Voltage < 0.8V	●		
	4	10 seconds continuous, Swing Pilot Press. Sensor Measurement Voltage < 0.3V	●		
	(Results / Symptoms) 1. Monitor – Swing Pilot Press. display failure 2. Control Function – IPC operation, Boom first operation failure (Checking list) 1. CD-24 (#B) – CN-52 (#18) Checking Open/Short 2. CD-24 (#A) – CN-51 (#32) Checking Open/Short 3. CD-24 (#C) – CN-51 (#31) Checking Open/Short				
138	0	Monitor – Select Attachment(breaker / crusher) 10 seconds continuous, Attachment Pilot Press. Sensor Measurement Voltage > 5.2V	●		
	1	Monitor – Select Attachment(breaker / crusher) 10 seconds continuous, 0.3V ≤ Attachment Pilot Press. Sensor Measurement Voltage < 0.8V	●		
	4	Monitor – Select Attachment(breaker / crusher) 10 seconds continuous, Attachment Pilot Press. Sensor Measurement Voltage < 0.3V	●		
	(Results / Symptoms) 1. Monitor – Attachment Pilot Press. display failure 2. Control Function – Option attachment flow control operation failure (Checking list) 1. CD-69 (#B) – CN-52 (#32) Checking Open/Short 2. CD-69 (#A) – CN-51 (#32) Checking Open/Short 3. CD-69 (#C) – CN-51 (#31) Checking Open/Short				
139 (N.A)	1	10 seconds continuous, 0.3V ≤ Option Pilot Press. Sensor Measurement Voltage < 0.8V			●
	4	10 seconds continuous, Option Pilot Press. Sensor Measurement Voltage < 0.3V			●
	(Results / Symptoms) 1. Monitor – Option Pilot Press. display failure 2. Control Function – Auto Idle operation failure (Checking list) 1. CD-100 (#B) – CN-52 (#21) Checking Open/Short 2. CD-100 (#A) – CN-51 (#3) Checking Open/Short 3. CD-100 (#C) – CN-1 (#6) Checking Open/Short				

※ Some error codes are not applied to this machine.

G : General

C : Crawler Type

W : Wheel Type

DTC		Diagnostic Criteria	Application		
HCESPN	FMI		G	C	W
140	5	(Detection) (When Pump regulator EPPR Current is more than 10 mA) 10 seconds continuous, Pump regulator EPPR drive current < 0 mA (Cancellation) (When Pump regulator EPPR Current is more than 10 mA) 3 seconds continuous, Pump regulator EPPR drive current ≥10 mA	●		
	6	(Detection) 10 seconds continuous, Pump regulator EPPR drive current > 1.0A (Cancellation) 3 seconds continuous, Pump regulator EPPR drive current ≤ 1.0 A	●		
	(Results / Symptoms) 1. Control Function – Pump horse power setting specification difference (Fuel efficiency/speed specification failure) (Checking list) 1. CN-75 (#1)-CN-54 (#1) Checking Open/Short 2. CN-75 (#2)-CN-54 (#28) Checking Open/Short				
141	5	(Model Parameter) mounting Boom Priority EPPR (Detection) (When Boom Priority EPPR Current is more than 10 mA) 10 seconds continuous, Boom Priority EPPR drive current < 0 mA (Cancellation) (When Boom Priority EPPR Current is more than 10 mA) 3 seconds continuous, Boom Priority EPPR drive current ≥ 10 mA	●		
	6	(Detection) 10 seconds continuous, Boom Priority EPPR drive current > 1.0 A (Cancellation) 3 seconds continuous, Boom Priority EPPR drive current ≤ 1.0 A	●		
	(Results / Symptoms) 1. Control Function – Boom first control operation failure (Checking list) 1. CN-133 (#1)-CN-54 (#4) Checking Open/Short 2. CN-133 (#2)-CN-54 (#34) Checking Open/Short				

※ Some error codes are not applied to this machine.

G : General

C : Crawler Type

W : Wheel Type

DTC		Diagnostic Criteria	Application		
HCESPN	FMI		G	C	W
143 (N.A)	5	(Detection) (When Travel EPPR Current is more than 10 mA) 10 seconds continuous, Travel EPPR drive current = 0 mA (Cancellation) (When Travel EPPR Current is more than 100 mA) 3 seconds continuous, Travel EPPR drive current \geq 10 mA			●
	6	(Detection) 10 seconds continuous, Travel EPPR drive current > 1.0 A (Cancellation) 3 seconds continuous, Travel EPPR drive current \leq 1.0 A			●
	(Results / Symptoms) 1. Control Function – cruise control operation failure (Checking list) 1. CN-246 (#2) – CN-54 (#39) Checking Open/Short 2. CN-246 (#1) – CN-51 (#40) Checking Open/Short				
145	5	(Model Parameter) mounting Remote Cooling Fan EPPR (Detection) (When Remote Cooling Fan EPPR Current is more than 10 mA) 10 seconds continuous, Remote Cooling Fan EPPR drive current = 0 mA (Cancellation) (When Remote Cooling Fan EPPR Current is more than 10 mA) 3 seconds continuous, Remote Cooling Fan EPPR drive current \geq 10 mA	●		
	6	(Detection) 10 seconds continuous, Remote Cooling Fan EPPR drive current > 1.0 A (Cancellation) 3 seconds continuous, Remote Cooling Fan EPPR drive current \leq 1.0 A	●		
	(Results / Symptoms) 1. Control Function – Remote fan control operation failure (Checking list) 1. CN-385 (#3) – CN-53 (#7) Checking Open/Short 2. CN-385 (#1) – CN-51 (#3) Checking Open/Short				

※ Some error codes are not applied to this machine.

G : General C : Crawler Type W : Wheel Type

DTC		Diagnostic Criteria	Application		
HCESPN	FMI		G	C	W
164 (N.A)	4	(Detection) (When Working Cutoff Relay is Off) 10 seconds continuous, Working Cutoff Relay drive unit Measurement Voltage $\leq 3.0V$ (Cancellation) (When Working Cutoff Relay is Off) 3 seconds continuous, Working Cutoff Relay drive unit Measurement Voltage $> 3.0V$			●
	6	(Detection) (When Working Cutoff Relay is On) 10 seconds continuous, Working Cutoff Relay drive current $> 6.5 A$ (Cancellation) (When Working Cutoff Relay is On) 3 seconds continuous, Working Cutoff Relay drive current $\leq 6.5 A$			●
(Results / Symptoms) 1. Control Function – (Wheel Excavator) In driving mode, attachment hydraulic pilot pressure cut off failure (Checking list) 1. CR-47 (#85) – CN-54 (#9) Checking Open/Short 2. CR-47 (#30, #86) – Fuse box (#28) Checking Open/Short					
166	4	(Detection) (When Power Max Solenoid is Off) 10 seconds continuous, Power Max Solenoid drive unit Measurement Voltage $\leq 3.0V$ (Cancellation) (When Power Max Solenoid is Off) 3 seconds continuous, Power Max Solenoid drive unit Measurement Voltage $> 3.0V$	●		
	6	(Detection) (When Power Max Solenoid is On) 5 seconds continuous, Power Max Solenoid drive current $> 4.5 A$ (Cancellation) (When Power Max Solenoid is On) 3 seconds continuous, Power Max Solenoid drive current $\leq 4.5 A$	●		
(Results / Symptoms) 1. Control Function – Voltage increase operation failure (Checking list) 1. CN-88 (#1) – CN-53 (#10) Checking Open/Short 2. CN-88 (#2) – Fuse box (#31) Checking Open/Short					

※ Some error codes are not applied to this machine.

G : General

C : Crawler Type

W : Wheel Type

DTC		Diagnostic Criteria	Application		
HCESPN	FMI		G	C	W
167		(Detection) (When Travel High Speed Solenoid is Off) 10 seconds continuous, Travel High Speed Solenoid drive unit Measurement Voltage $\leq 3.0V$ (Cancellation) (When Travel High Speed Solenoid is Off) 3 seconds continuous, Travel High Speed Solenoid drive unit Measurement Voltage $> 3.0V$		●	
		4 (When Parking mode is not) (Detection) (When Travel High Speed Solenoid is Off) 10 seconds continuous, Travel High Speed Solenoid drive unit Measurement Voltage $\leq 3.0V$ (Cancellation) (When Travel High Speed Solenoid is Off) 3 seconds continuous, Travel High Speed Solenoid drive unit Measurement Voltage $> 3.0V$			●
	6 (Detection) (When Travel High Speed Solenoid is On) 10 seconds continuous, Travel High Speed Solenoid drive current $> 4.5 A$ (Cancellation) (When Travel High Speed Solenoid is On) 3 seconds continuous, Travel High Speed Solenoid drive current $\leq 4.5 A$	●			
	(Results / Symptoms) 1. Control Function – driving in 1/2 transmission operation failure (Checking list) 1. CN-70 (#1) – CN-52 (#5) Checking Open/Short 2. CN-70 (#2) – Fuse box (#31) Checking Open/Short				

※ Some error codes are not applied to this machine.

G : General

C : Crawler Type

W : Wheel Type

DTC		Diagnostic Criteria	Application		
HCESPN	FMI		G	C	W
169	4	Monitor – Selecting attachment(breaker / crusher) (Detection) (When Attachment Conflux Solenoid is Off) 10 seconds continuous, Attachment Conflux Solenoid drive unit Measurement Voltage \leq 3.0V (Cancellation) (When Attachment Conflux Solenoid is Off) 3 seconds continuous, Attachment Conflux Solenoid drive unit Measurement Voltage $>$ 3.0V	●		
	6	(Detection) (When Attachment Conflux Solenoid is On) 10 seconds continuous, Attachment Conflux Solenoid drive Current $>$ 6.5 A (Cancellation) (When Attachment Conflux Solenoid is On) 3 seconds continuous, Attachment Conflux Solenoid drive Current \leq 6.5 A	●		
(Results / symptoms) 1. Control Function – Option attachment flow control – Joining operation failure (Eco breaker mode, crusher mode) (Checking list) 1. CN-237 (#1) – CN-52 (#16) Checking Open/Short 2. CN-237 (#2) – Fuse box (#28) Checking Open/Short					
170	4	(Model Parameter) mounting Arm Regenerating Solenoid (Detection) (When Arm Regeneration Solenoid is Off) 10 seconds continuous, Arm Regeneration Solenoid drive unit Measurement Voltage \leq 3.0V (Cancellation) (When Arm Regeneration Solenoid is Off) 3 seconds continuous, Arm Regeneration Solenoid drive unit Measurement Voltage $>$ 3.0V	●		
	6	(Detection) (When Arm Regeneration Solenoid is On) 10 seconds continuous, Arm Regeneration Solenoid drive current $>$ 4.5 A (Cancellation) (When Arm Regeneration Solenoid is On) 3 seconds continuous, Arm Regeneration Solenoid drive current \leq 4.5 A	●		
(Results / symptoms) 1. Control Function – Arm regeneration operation failure (Checking list) 1. CN-135 (#1) – CN-52 (#7) Checking Open/Short 2. CN-135 (#2) – Fuse box (#31) Checking Open/Short					

※ Some error codes are not applied to this machine.

G : General

C : Crawler Type

W : Wheel Type

DTC		Diagnostic Criteria	Application		
HCESPN	FMI		G	C	W
171	4	Monitor – Selecting attachment(crusher) (Detection) (When Attachment Safety Solenoid is Off) 10 seconds continuous, Attachment Safety Solenoid drive unit Measurement Voltage ≤ 3.0V (Cancellation) (When Attachment Safety Solenoid is Off) 3 seconds continuous, Attachment Safety Solenoid drive unit Measurement Voltage > 3.0V	●		
	6	(Detection) (When Attachment Safety Solenoid is On) 10 seconds continuous, Attachment Safety Solenoid drive current > 6.5 A (Cancellation) (When Attachment Safety Solenoid is On) 3 seconds continuous, Attachment Safety Solenoid drive current ≤ 6.5 A	●		
(Results / Symptoms) 1. Control Function – Option attachment flow control – Option spool pilot pressure cut off failure (crusher mode) (Checking list) 1. CN-149 (#1) – CN-53 (#9) Checking Open/Short 2. CN-149 (#2) – Fuse box (#28) Checking Open/Short					
179	4	Monitor – Selecting attachment(breaker / crusher) (Detection) (When Breaker Operating Solenoid is Off) 10 seconds continuous, Attachment Safety Solenoid drive unit Measurement Voltage ≤ 3.0V (Cancellation) (When Breaker Operating Solenoid is Off) 3 seconds continuous, Attachment Safety Solenoid drive unit Measurement Voltage > 3.0V	●		
	6	(Detection) (When Breaker Operating Solenoid is On) 10 seconds continuous, Attachment Safety Solenoid drive current > 6.5 A (Cancellation) (When Breaker Operating Solenoid is On) 3 seconds continuous, Attachment Safety Solenoid drive current ≤ 6.5 A	●		
(Results / Symptoms) 1. Control Function – Option attachment flow control – Breaker operation failure (breaker mode) (Checking list) 1. CN-66 (#1) – CN-52 (#8) Checking Open/Short 2. CN-66 (#2) – Fuse box (#34) Checking Open/Short					

※ Some error codes are not applied to this machine.

G : General

C : Crawler Type

W : Wheel Type

DTC		Diagnostic Criteria	Application		
HCESPN	FMI		G	C	W
181 (N.A)	4	(Model Parameter) mounting Reverse Cooling Fan Solenoid (Detection) (When Reverse Cooling Fan Solenoid is Off) 10 seconds continuous, Reverse Cooling Fan Solenoid drive unit Measurement Voltage \leq 3.0V (Cancellation) (When Reverse Cooling Fan Solenoid is Off) 3 seconds continuous, Reverse Cooling Fan Solenoid drive unit Measurement Voltage $>$ 3.0V	●		
	6	(Detection) (When Reverse Cooling Fan Solenoid is On) 10 seconds continuous, Reverse Cooling Fan Solenoid drive current $>$ 4.5 A (Cancellation) (When Reverse Cooling Fan Solenoid is On) 3 seconds continuous, Reverse Cooling Fan Solenoid drive current \leq 4.5 A	●		
(Results / Symptoms) 1. Control Function – Cooling Fan reverse control operation failure (not applicable)					
188	5	(Detection) (When Pump P1 regulator EPPR current is equal or more than 300 mA) 10 seconds continuous, Pump P1 regulator EPPR drive current $<$ 100 mA (Cancellation) (When Pump P1 regulator EPPR current is equal or more than 300 mA) 3 seconds continuous, Pump P1 regulator EPPR drive current \geq 100 mA	●		
	6	(Detection) 10 seconds continuous, Attachment Flow EPPR 1 drive current $>$ 1.0 A (Cancellation) 3 seconds continuous, Attachment Flow EPPR 1 drive current \leq 1.0 A	●		
(Results / Symptoms) 1. Control Function – IPC operation failure, Option attachment flow control operation failure (Checking list) 1. CN-242 (#2) – CN-54 (#27) Checking Open/Short 2. CN-242 (#1) – CN-54 (#2) Checking Open/Short					

※ Some error codes are not applied to this machine.

G : General

C : Crawler Type

W : Wheel Type

DTC		Diagnostic Criteria	Application		
HCESPN	FMI		G	C	W
189	5	(Detection) (When Pump P2 regulator EPPR current is equal or more than 300 mA) 10 seconds continuous, Pump P2 regulator EPPR drive current < 100 mA (Cancellation) (When Pump P2 regulator EPPR current is equal or more than 300 mA) 3 seconds continuous, Pump P2 regulator EPPR drive current ≥ 100 mA	●		
	6	(Detection) 10 seconds continuous, Attachment Flow EPPR 2 drive current > 1.0 A (Cancellation) 3 seconds continuous, Attachment Flow EPPR 2 drive current ≤ 1.0 A	●		
(Results / Symptoms) 1. Control Function – Option attachment flow control operation failure (Checking list) 1. CN-378 (#2) – CN-54 (#26) Checking Open/Short 2. CN-378 (#1) – CN-54 (#3) Checking Open/Short					
196 (N.A)	0	HW145 10 seconds continuous, Attachment flow control EPPR 1 press. Sensor Measurement Voltage > 5.2V			
	1	HW145 10 seconds continuous, 0.3V ≤ Attachment flow control EPPR 1 press. Sensor Measurement Voltage < 0.8V			
	4	HW145 10 seconds continuous, Attachment flow control EPPR 1 press. Sensor Measurement Voltage < 0.3V			
	(Results / Symptoms) 1. Control Function – Driving second pump joining function operation failure (Checking list) 1. CD-93 (#B) – CN-52 (#34) Checking Open/Short 2. CD-93 (#A) – CN-51 (#32) Checking Open/Short 3. CD-93 (#C) – CN-51 (#31) Checking Open/Short				
200	0	10 seconds continuous, Pump EPPR Press. Sensor Measurement Voltage > 5.2V	●		
	1	10 seconds continuous, 0.3V ≤ Pump EPPR Press. Sensor Measurement Voltage < 0.8V	●		
	4	10 seconds continuous, Pump EPPR Press. Sensor Measurement Voltage < 0.3V	●		
	(Results / Symptoms) 1. Monitor – Pump EPPR Press. display failure 2. Control Function – Pump input horse power control failure, Overload at compensation control operation failure (Fuel efficiency/speed performance failure) (Checking list) 1. CD-44 (#B) – CN-51 (#13) Checking Open/Short 2. CD-44 (#A) – CN-51 (#32) Checking Open/Short 3. CD-44 (#C) – CN-51 (#31) Checking Open/Short				

※ Some error codes are not applied to this machine.

G : General

C : Crawler Type

W : Wheel Type

DTC		Diagnostic Criteria	Application		
HCESPN	FMI		G	C	W
205 (N.A)	0	(Mounting pressure sensor) 10 seconds continuous, Boom Cylinder Rod Press. Sensor Measurement Voltage > 5.2V	●		
	1	(Mounting pressure sensor) 10 seconds continuous, 0.3V ≤ Boom Cylinder Rod Press. Sensor Measurement Voltage < 0.8V	●		
	4	(Mounting pressure sensor) 10 seconds continuous, Boom Cylinder Rod Press. Sensor Measurement Voltage < 0.3V	●		
	(Results / Symptoms) 1. Monitor – Boom Cylinder Rod Press. display failure 2. Control Function – Boom floating control operation failure (Checking list) 1. CD-124 (#B) – CN-52 (#25) Checking Open/Short 2. CD-124 (#A) – CN-51 (#32) Checking Open/Short 3. CD-124 (#C) – CN-51 (#31) Checking Open/Short				
218 (N.A)	4	Mounting pressure sensor (HCESPN128 or HCESPN 205) (Detection) (When Boom Up Floating Solenoid is Off) 10 seconds continuous, Boom Up Floating Solenoid drive unit Measurement Voltage ≤ 3.0V (Cancellation) (When Boom Up Floating Solenoid is Off) 3 seconds continuous, Boom Up Floating Solenoid drive unit Measurement Voltage > 3.0V	●		
	6	(Detection) (When Boom Up Floating Solenoid is On) 10 seconds continuous, Boom Up Floating Solenoid drive current > 6.5 A (Cancellation) (When Boom Up Floating Solenoid is On) 3 seconds continuous, Boom Up Floating Solenoid drive current ≤ 6.5 A	●		
	(Results / Symptoms) 1. Control Function – Boom floating control operation failure (Checking list) 1. CN-368 (#1) – CN-53 (#05) Checking Open/Short 2. CN-368 (#2) – Fuse box (#19) Checking Open/Short				

※ Some error codes are not applied to this machine.

G : General

C : Crawler Type

W : Wheel Type

DTC		Diagnostic Criteria	Application		
HCESPN	FMI		G	C	W
220 (N.A)	4	Mounting pressure sensor (HCESPN 128 or 205) (Detection) (When Boom Down Pilot Pressure Cutoff Solenoid is Off) 10 seconds continuous, Boom Down Pilot Pressure Cutoff Solenoid drive unit Measurement Voltage $\leq 3.0V$ (Cancellation) (When Boom Down Pilot Pressure Cutoff Solenoid is Off) 3 seconds continuous, Boom Down Pilot Pressure Cutoff Solenoid drive unit Measurement Voltage $> 3.0V$	●		
	6	(Detection) (When Boom Down Pilot Pressure Cutoff Solenoid is On) 10 seconds continuous, Boom Down Pilot Pressure Cutoff Solenoid drive current $> 6.5 A$ (Cancellation) (When Boom Down Pilot Pressure Cutoff Solenoid is On) 3 seconds continuous, Boom Down Pilot Pressure Cutoff Solenoid drive current $\leq 6.5 A$	●		
(Results / Symptoms) 1. Control Function – Boom floating control operation failure (Checking list) 1. CN-369 (#1) – CN-53 (#08) Checking Open/Short 2. CN-369 (#2) – Fuse box (#19) Checking Open/Short					
221	5	Monitor – Selecting attachment(breaker / crusher) (Detection) (When ATT Relief Setting EPPR 1 Current is equal or more than 10 mA) 10 seconds continuous, ATT Relief Setting EPPR 1 drive current = 0 mA (Cancellation) ATT Relief Setting EPPR 1 Current is equal or more than 10 mA) 3 seconds continuous, ATT Relief Setting EPPR 1 drive current $\geq 10 mA$	●		
	6	(Detection) 10 seconds continuous, ATT Relief Setting EPPR 1 drive current $> 1.0 A$ (Cancellation) 3 seconds continuous, ATT Relief Setting EPPR 1 drive current $\leq 1.0 A$	●		
(Results / Symptoms) 1. Control Function – Option attachment flow control – P1 relief pressure setting failure (Checking list) 1. CN-365 (#2) – CN-54 (#17) Checking Open/Short 2. CN-365 (#1) – CN-54 (#9) Checking Open/Short					

※ Some error codes are not applied to this machine.

G : General

C : Crawler Type

W : Wheel Type

DTC		Diagnostic Criteria	Application		
HCESPN	FMI		G	C	W
222	5	Monitor – Selecting attachment(crusher) (Detection) (When ATT Relief Setting EPPR 2 Current is equal or more than 10 mA) 10 seconds continuous, ATT Relief Setting EPPR 2 drive current = 0 mA (Cancellation) (When ATT Relief Setting EPPR 2 Current is equal or more than 10 mA) 3 seconds continuous, ATT Relief Setting EPPR 2 drive current ≥ 10mA	●		
	6	(Detection) 10 seconds continuous, ATT Relief Setting EPPR 2 drive current > 1.0 A (Cancellation) 3 seconds continuous, ATT Relief Setting EPPR 2 drive current ≤ 1.0 A	●		
(Results / Symptoms) 1. Control Function – Option attachment flow control – P2 relief pressure setting failure (Checking list) 1. CN-366 (#2) – CN-54 (#17) Checking Open/Short 2. CN-366 (#1) – CN-54 (#10) Checking Open/Short					
301	3	10 seconds continuous, Fuel Level Measurement Voltage > 3.8V	●		
	4	10 seconds continuous, Fuel Level Measurement Voltage < 0.3V	●		
	(Results / Symptoms) 1. Monitor – Fuel remaining display failure (Checking list) 1. CD-2 (#2) – CN-51 (#19) Checking Open/Short 2. CD-2 (#1) – CN-51 (#24) Checking Open/Short				
325	4	(Model Parameter) mounting Fuel Warmer Relay (Detection) (When Fuel Warmer Relay is Off) 10 seconds continuous, Fuel Warmer Relay drive unit Measurement Voltage ≤ 3.0V (Cancellation) (When Fuel Warmer Relay is Off) 3 seconds continuous, Fuel Warmer Relay drive unit Measurement Voltage > 3.0V	●		
	6	(Detection) (When Fuel Warmer Relay is On) 10 seconds continuous, Fuel Warmer Relay drive current > 4.5 A (Cancellation) (When Fuel Warmer Relay is On) 3 seconds continuous, Fuel Warmer Relay drive current ≤ 4.5 A	●		
(Results / Symptoms) 1. Control Function – Fuel warmer operation failure (Checking list) 1. CR-46 (#85) – CN-52 (#13) Checking Open/Short 2. CR-46 (##30, #86) – Fuse box (#24) Checking Open/Short					

※ Some error codes are not applied to this machine.

G : General

C : Crawler Type

W : Wheel Type

DTC		Diagnostic Criteria	Application		
HCESPN	FMI		G	C	W
501 (N.A)	0	10 seconds continuous, Transmission Oil Press. Sensor Measurement Voltage > 5.2V			●
	1	10 seconds continuous, 0.3V ≤ Transmission Oil Press. Sensor Measurement Voltage < 0.8V			●
	4	10 seconds continuous, Transmission Oil Press. Sensor Measurement Voltage < 0.3V			●
	(Results / Symptoms) 1. Monitor – Transmission Oil Press. display failure, Transmission Oil low pressure warning failure (Checking list) 1. CD-5 (#B) – CN-52 (#26) Checking Open/Short 2. CD-5 (#A) – CN-51 (#32) Checking Open/Short 3. CD-5 (#C) – CN-51 (#31) Checking Open/Short				
503 (N.A)	0	10 seconds continuous, Brake Oil Press. Sensor Measurement Voltage > 5.2V			●
	1	10 seconds continuous, 0.3V ≤ Brake Oil Press. Sensor Measurement Voltage < 0.8V			●
	4	10 seconds continuous, Brake Oil Press. Sensor Measurement Voltage < 0.3V			●
	(Results / Symptoms) 1. Monitor – Brake Oil Press. display failure, Brake Oil low pressure warning failure (Checking list) 1. CD-3 (#B) – CN-52 (#29) Checking Open/Short 2. CD-3 (#A) – CN-51 (#32) Checking Open/Short 3. CD-3 (#C) – CN-51 (#31) Checking Open/Short				
505 (N.A)	0	10 seconds continuous, Working Brake Press. Sensor Measurement Voltage > 5.2V			●
	1	10 seconds continuous, 0.3V ≤ Working Brake Press. Sensor Measurement Voltage < 0.8V			●
	4	10 seconds continuous, Working Brake Press. Sensor Measurement Voltage < 0.3V			●
	(Results / Symptoms) 1. Monitor – Working Brake Oil Press. display failure, Working Brake Oil low pressure warning failure (Checking list) 1. CD-38 (#B) – CN-51 (#30) Checking Open/Short 2. CD-38 (#A) – CN-51 (#32) Checking Open/Short 3. CD-38 (#C) – CN-51 (#31) Checking Open/Short				

※ Some error codes are not applied to this machine.

G : General

C : Crawler Type

W : Wheel Type

DTC		Diagnostic Criteria	Application		
HCESPN	FMI		G	C	W
514 (N.A)	4	(Detection) (When Parking Relay is Off) 10 seconds continuous, Parking Relay drive unit Measurement Voltage \leq 3.0V (Cancellation) (When Parking Relay is Off) 3 seconds continuous, Parking Relay drive unit Measurement Voltage $>$ 3.0V			●
	6	(Detection) (When Parking Relay is On) 10 seconds continuous, Parking Relay drive current $>$ 6.5 A (Cancellation) (When Parking Relay is On) 3 seconds continuous, Parking Relay drive current \leq 6.5 A			●
(Results / Symptoms) 1. Control Function – Parking Relay operation failure (Checking list) 1. CR-66 (#1) – CN-53 (#11) Checking Open/Short 2. CR-66 (#2) – Fuse box (#30) Checking Open/Short					
517 (N.A)	4	(Detection) (When Traveling Cutoff Relay is Off) 10 seconds continuous, Traveling Cutoff Relay drive unit Measurement Voltage \leq 3.0V (Cancellation) (When Traveling Cutoff Relay is Off) 3 seconds continuous, Traveling Cutoff Relay drive unit Measurement Voltage $>$ 3.0V			●
	6	(Detection) (When Traveling Cutoff Relay is On) 10 seconds continuous, Traveling Cutoff Relay drive current $>$ 6.5 A (Cancellation) (When Traveling Cutoff Relay is On) 3 seconds continuous, Traveling Cutoff Relay drive current \leq 6.5 A			●
(Results / Symptoms) 1. Control Function – Traveling Cutoff Relay operation failure (Checking list) 1. CR-47 (#85) – CN-53 (#04) Checking Open/Short 2. CR-47 (#86) – Fuse box (#28) Checking Open/Short					

※ Some error codes are not applied to this machine.

G : General

C : Crawler Type

W : Wheel Type

DTC		Diagnostic Criteria	Application		
HCESPN	FMI		G	C	W
525 (N.A)	4	(Detection) (When Ram Lock Solenoid is Off) 10 seconds continuous, Ram Lock Solenoid drive unit Measurement Voltage $\leq 3.0V$ (Cancellation) (When Ram Lock Solenoid is Off) 3 seconds continuous, Ram Lock Solenoid drive unit Measurement Voltage $> 3.0V$			●
	6	(Detection) (When Ram Lock Solenoid is On) 10 seconds continuous, Ram Lock Solenoid drive current $> 6.5 A$ (Cancellation) (When Ram Lock Solenoid is On) 3 seconds continuous, Ram Lock Solenoid drive current $\leq 6.5 A$			●
(Results / Symptoms) 1. Control Function – Ram lock control operation failure (Checking list) 1. CN-69 (#1) – CN-53 (#12) Checking Open/Short 2. CN-69 (#2) – Fuse box (#33) Checking Open/Short					
527 (N.A)	4	(Detection) (When Creep Solenoid is Off) 10 seconds continuous, Creep Solenoid drive unit Measurement Voltage $\leq 3.0V$ (Cancellation) (When Creep Solenoid is Off) 3 seconds continuous, Creep Solenoid drive unit Measurement Voltage $> 3.0V$			●
	6	(Detection) (When Creep Solenoid is On) 10 seconds continuous, Creep Solenoid drive current $> 6.5 A$ (Cancellation) (When Creep Solenoid is On) 3 seconds continuous, Creep Solenoid drive current $\leq 6.5 A$			●
(Results / Symptoms) 1. Control Function – Creep mode operation failure (Checking list) 1. CN-206 (#1) – CN-52 (#17) Checking Open/Short 2. CN-206 (#2) – Fuse box (#30) Checking Open/Short					

※ Some error codes are not applied to this machine.

G : General

C : Crawler Type

W : Wheel Type

DTC		Diagnostic Criteria	Application		
HCESPN	FMI		G	C	W
530 (N.A)	0	10 seconds continuous, Travel Forward Press. Sensor Measurement Voltage > 5.2V			●
	1	10 seconds continuous, 0.3V ≤ Travel Forward Press. Sensor Measurement Voltage < 0.8V			●
	4	10 seconds continuous, Travel Forward Press. Sensor Measurement Voltage < 0.3V			●
	(Results / Symptoms) 1. Monitor – Travel Forward Press. display failure 2. Control Function – Driving interoperability power control operation failure (Checking list) 1. CD-73 (#B) – CN-51 (#20) Checking Open/Short 2. CD-73 (#A) – CN-51 (#32) Checking Open/Short 3. CD-73 (#C) – CN-51 (#31) Checking Open/Short				
531 (N.A)	1	10 seconds continuous, 0.3V ≤ Travel Reverse Press. Sensor Measurement Voltage < 0.8V			●
	4	10 seconds continuous, Travel Reverse Press. Sensor Measurement Voltage < 0.3V			●
	(Results / Symptoms) 1. Monitor – Travel Reverse Press. display failure 2. Control Function – Driving interoperability power control operation failure (Checking list) 1. CD-74 (#B) – CN-51 (#20) Checking Open/Short 2. CD-74 (#A) – CN-51 (#32) Checking Open/Short 3. CD-74 (#C) – CN-51 (#31) Checking Open/Short				
705	0	10 seconds continuous, Battery input Voltage > 35V	●		
	1	10 seconds continuous, Battery input Voltage < 18V	●		
	(Results / Symptoms) 1. Control Function – Startup impossibility (Checking list) 1. CS-74A (#1) – CN-51 (#01) Checking Open/Short				
707	1	(When Engine is equal or more than 400 rpm) 10 seconds continuous, Alternator Node I Measurement Voltage < 18V (In case 12v goods, Alternator Node I Measurement Voltage < 9V)	●		
	(Results / Symptoms) 1. Control Function – Battery charging circuit failure (Checking list) 1. CS-74A (#1) – CN-51 (#15) Checking Open/Short				

※ Some error codes are not applied to this machine.

G : General

C : Crawler Type

W : Wheel Type

DTC		Diagnostic Criteria	Application		
HCESPN	FMI		G	C	W
714 (N.A)	3	(Model Parameter) Mounting Acc. Dial 10 seconds continuous, Acc. Dial Measurement Voltage > 5.2V	●		
	4	(Model Parameter) Mounting Acc. Dial 10 seconds continuous, Acc. Dial Measurement Voltage < 0.3V	●		
	(Results / Symptoms) 1. Monitor – Acc. Dial Voltage display failure 2. Control Function – Engine rpm control failure (Checking list) 1. CN-7 (#15) – CN-52 (#33) Checking Open/Short				
722	4	(Detection) (When Travel Alarm (Buzzer) Sound is Off) 10 seconds continuous, Travel Alarm (Buzzer) Sound Relay drive unit Measurement Voltage ≤ 3.0V (Cancellation) (When Travel Alarm (Buzzer) Sound Relay is Off) 3 seconds continuous, Travel Alarm (Buzzer) Sound Relay drive unit Measurement Voltage > 3.0V	●		
	6	(Detection) (When Travel Alarm (Buzzer) Sound is On) 10 seconds continuous, Travel Alarm (Buzzer) Sound Relay drive current > 4.5 A (Cancellation) (When Travel Alarm (Buzzer) Sound is On) 3 seconds continuous, Travel Alarm (Buzzer) Sound Relay drive current ≤ 4.5 A	●		
(Results / Symptoms) 1. Control Function – Driving alarm operation failure (Checking list) 1. CN-81 (#1) – CN-52 (#9) Checking Open/Short 2. CN-81 (#2) – Fuse box (#31) Checking Open/Short					
831	2	(When mounting the A/C Controller) 60 seconds continuous, A/C Controller Communication Data Error	●		
	(Results / Symptoms) 1. Control Function – A/C Controller operation failure (Checking list) 1. CN-11 (#8) – CN-51 (#9) Checking Open/Short 2. CN-11 (#7) – CN-51 (#8) Checking Open/Short				
840	2	60 seconds continuous, Cluster Communication Data Error	●		
	(Results / Symptoms) 1. Control Function – Cluster operation failure (Checking list) 1. CN-56A (#5) – CN-52 (#1) Checking Open/Short 2. CN-56A (#4) – CN-52 (#2) Checking Open/Short				

※ Some error codes are not applied to this machine.

G : General

C : Crawler Type

W : Wheel Type

DTC		Diagnostic Criteria	Application		
HCESPN	FMI		G	C	W
841	2	10 seconds continuous, ECM Communication Data Error	●		
	(Results / Symptoms) 1. Control Function – ECM operation failure (Checking list) 1. CN-93 (#22) – CN-52 (#2) Checking Open/Short 2. CN-93 (#46) – CN-52 (#1) Checking Open/Short				
848	2	(When mounting the Jog Dial Module) 60 seconds continuous, Jog Dial Module Communication Data Error	●		
	(Results / Symptoms) 1. Control Function – Jog Dial Module operation failure (Checking list) 1. CN-363 (#4) – CN-51 (#9) Checking Open/Short 2. CN-363 (#10) – CN-51 (#8) Checking Open/Short				
850	2	(When mounting the RMCU) 60 seconds continuous, RMCU communication Data Error	●		
	(Results / Symptoms) 1. Control Function – RMCU operation failure (Checking list) 1. CN-125A (#3) – CN-51 (#9) Checking Open/Short 2. CN-125A (#11) – CN-51 (#8) Checking Open/Short				
866	2	(When mounting the AAVM) 60 seconds continuous, AAVM communication Data Error	●		
	(Results / Symptoms) 1. Control Function – AAVM operation failure (Checking list) 1. CN-9 (#5) – CN-51 (#9) Checking Open/Short 2. CN-9 (#6) – CN-51 (#8) Checking Open/Short				
867	2	60 seconds continuous, RDU communication Data Error	●		
	(Results / Symptoms) 1. Control Function – RDU operation failure (Checking list) 1. CN-376 (#10) – CN-51 (#9) Checking Open/Short 2. CN-376 (#18) – CN-51 (#8) Checking Open/Short				

※ Some error codes are not applied to this machine.

G : General

C : Crawler Type

W : Wheel Type

DTC		Diagnostic Criteria	Application		
HCESPN	FMI		G	C	W
868	2	60 seconds continuous, Switch Controller communication Data Error	●		
	(Results / Symptoms) 1. Control Function – Switch Controller operation failure (Checking list) 1. CN-56A (#7) – CN-51 (#8) Checking Open/Short 2. CN-56A (#6) – CN-51 (#9) Checking Open/Short				
869	2	(When mounting the BKCU) 60 seconds continuous, BKCU communication Data Error	●		
	(Results / Symptoms) 1. Control Function – BKCU operation failure (Checking list) 1. CS-2B (#A) – CN-51 (#9) Checking Open/Short 2. CS-2B (#B) – CN-51 (#8) Checking Open/Short				

※ Some error codes are not applied to this machine.

G : General

C : Crawler Type

W : Wheel Type

4. ENGINE FAULT CODE

Fault code J1939 SPN J1939 FMI	Item	Description
111 629 12	Engine control module critical internal failure	Bad intelligent device or component
122 102 3	Intake manifold 1 pressure sensor circuit	Voltage above normal, or shorted to high source
123 102 4	Intake manifold 1 pressure sensor circuit	Voltage below normal, or shorted to low source
124 102 16	Intake manifold 1 pressure	Data valid but above normal operating range - moderately severe level
125 102 18	Intake manifold 1 pressure	Data valid but below normal operating range - moderately severe level
133 974 3	Remote accelerator pedal or lever position sensor 1 circuit	Voltage above normal, or shorted to high source
134 974 4	Remote accelerator pedal or lever position sensor 1 circuit	Voltage below normal, or shorted to low source
135 100 3	Engine oil rifle pressure 1 sensor circuit	Voltage above normal, or shorted to high source
141 100 4	Engine oil rifle pressure 1 sensor circuit	Voltage below normal, or shorted to low source
143 100 18	Engine oil rifle pressure	Data valid but below normal operating range - moderately severe level
144 110 3	Engine coolant temperature 1 sensor circuit	Voltage above normal, or shorted to high source
145 110 4	Engine coolant temperature 1 sensor circuit	Voltage below normal, or shorted to low source
146 110 16	Engine coolant temperature	Data valid but above normal operating range - moderately severe level
147 91 1	Accelerator pedal or lever position 1 sensor circuit frequency	Data valid but below normal operating range
148 91 0	Accelerator pedal or lever position sensor 1	Data valid but above normal operational range - most severe level
151 110 0	Engine coolant temperature	Data valid but above normal operational range - most severe level

※ Some fault codes are not applied to this machine.

Fault code J1939 SPN J1939 FMI	Item	Description
153 105 3	Intake manifold 1 temperature sensor circuit	Voltage above normal, or shorted to high source
154 105 4	Intake manifold 1 temperature sensor circuit	Voltage below normal, or shorted to low source
187 3510 4	Sensor supply 2 circuit	Voltage below normal, or shorted to low source
197 111 18	Coolant level	Data valid but below normal operating range - moderately severe level
227 3510 3	Sensor supply 2 circuit	Voltage above normal, or shorted to high source
234 190 0	Engine crankshaft speed/position	Data valid but above normal operational range - most severe level
235 111 1	Coolant level	Data valid but below normal operational range - most severe level
237 644 2	External speed command input (Multiple unit synchronization)	Data erratic, intermittent or incorrect
238 3511 4	Sensor supply 3 circuit	Voltage below normal, or shorted to low source
239 3511 3	Sensor supply 3 circuit	Voltage above normal, or shorted to high source
241 84 2	Wheel-based vehicle speed	Data erratic, intermittent or incorrect
242 84 10	Wheel-based vehicle speed sensor circuit tampering has been detected	Abnormal rate of change
271 1347 4	Engine fuel pump pressurizing assembly 1 circuit	Voltage below normal, or shorted to low source
272 1347 3	Engine fuel pump pressurizing assembly 1 circuit	Voltage above normal, or shorted to high source
285 639 9	SAE J1939 multiplexing pgn timeout error	Abnormal update rate
286 639 13	SAE J1939 multiplexing configuration error	Out of calibration

※ Some fault codes are not applied to this machine.

Fault code J1939 SPN J1939 FMI	Item	Description
288 974 19	SAE J1939 multiplexing remote accelerator pedal or lever position sensor system	Received network data in error
293 441 3	Auxiliary temperature sensor input 1 circuit	Voltage above normal, or shorted to high source
294 441 4	Auxiliary temperature sensor input 1 circuit	Voltage below normal, or shorted to low source
297 1388 3	Auxiliary pressure sensor input 2 circuit	Voltage above normal, or shorted to high source
298 1388 4	Auxiliary pressure sensor input 2 circuit	Voltage below normal, or shorted to low source
322 651 5	Injector solenoid driver cylinder 1 circuit	Current below normal or open circuit
324 653 5	Injector solenoid driver cylinder 3 circuit	Current below normal or open circuit
331 652 5	Injector solenoid driver cylinder 2 circuit	Current below normal or open circuit
332 654 5	Injector solenoid driver cylinder 4 circuit	Current below normal or open circuit
334 110 2	Engine coolant temperature	Data erratic, intermittent or incorrect
343 629 12	Engine control module warning internal hardware failure	Bad intelligent device or component
349 191 16	Transmission output shaft speed	Data valid but above normal operating range - moderately severe level
351 3597 12	Injector power supply	Bad intelligent device or component
352 3509 4	Sensor supply 1 circuit	Voltage below normal, or shorted to low source
386 3509 3	Sensor supply 1 circuit	Voltage above normal, or shorted to high source
415 100 1	Engine oil rifle pressure	Data valid but below normal operational range - most severe level

※ Some fault codes are not applied to this machine.

Fault code J1939 SPN J1939 FMI	Item	Description
418 97 15	Water in fuel indicator	Data valid but above normal operating range - least severe level
428 97 3	Water in fuel indicator sensor circuit	Voltage above normal, or shorted to high source
429 97 4	Water in fuel indicator sensor circuit	Voltage below normal, or shorted to low source
431 558 2	Accelerator pedal or lever idle validation switch	Data erratic, intermittent or incorrect
432 558 13	Accelerator pedal or lever idle validation switch circuit	Out of calibration
435 100 2	Engine oil rifle pressure	Data erratic, intermittent or incorrect
451 157 3	Injector metering rail 1 pressure sensor circuit	Voltage above normal, or shorted to high source
452 157 4	Injector metering rail 1 pressure sensor circuit	Voltage below normal, or shorted to low source
488 105 16	Intake manifold 1 temperature	Data valid but above normal operating range - moderately severe level
489 191 18	Transmission output shaft speed	Data valid but below normal operating range - moderately severe level
497 1377 2	Multiple unit synchronization switch	Data erratic, intermittent or incorrect
515 3514 3	Sensor supply 6 circuit	Voltage above normal, or shorted to high source
516 3514 4	Sensor supply 6 circuit	Voltage below normal, or shorted to low source
527 702 3	Auxiliary input/output 2 circuit	Voltage above normal, or shorted to high source
529 703 3	Auxiliary input/output 3 circuit	Voltage above normal, or shorted to high source
553 157 16	Injector metering rail 1 pressure	Data valid but above normal operating range - moderately severe level

※ Some fault codes are not applied to this machine.

Fault code J1939 SPN J1939 FMI	Item	Description
559 157 18	Injector metering rail 1 pressure	Data valid but below normal operating range - moderately severe level
584 677 3	Starter relay driver circuit	Voltage above normal, or shorted to high source
585 677 4	Starter relay driver circuit	Voltage below normal, or shorted to low source
599 640 14	Auxiliary commanded dual output shutdown	Special instructions
611 1383 31	Engine shut down hot	Condition exists
649 1378 31	Engine oil change interval	Condition exists
687 103 18	Turbocharger 1 speed	Data valid but below normal operating range - moderately severe level
689 190 2	Engine crankshaft speed/position	Data erratic, intermittent or incorrect
691 1172 3	Turbocharger 1 compressor intake temperature circuit	Voltage above normal, or shorted to high source
692 1172 4	Turbocharger 1 compressor intake temperature circuit	Voltage below normal, or shorted to low source
693 1172 7	Turbocharger 1 compressor intake temperature	Data erratic, intermittent or incorrect
731 723 7	Engine speed / position camshaft and crankshaft misalignment	Mechanical system not responding or out of adjustment
741 1176 3	Turbocharger 1 compressor intake pressure circuit	Voltage above normal, or shorted to high source
742 1176 4	Turbocharger 1 compressor intake pressure circuit	Voltage below normal, or shorted to low source
743 1176 2	Turbocharger 1 compressor intake pressure	Data erratic, intermittent or incorrect

※ Some fault codes are not applied to this machine.

Fault code J1939 SPN J1939 FMI	Item	Description
769 597 3	Brake switch circuit	Voltage above normal, or shorted to high source
771 597 4	Brake switch circuit	Voltage below normal, or shorted to low source
778 723 2	Engine camshaft speed / position sensor	Data erratic, intermittent or incorrect
1117 3597 2	Power supply lost with ignition on	Data erratic, intermittent or incorrect
1239 2623 3	Accelerator pedal or lever position sensor 2 circuit	Voltage above normal, or shorted to high source
1241 2623 4	Accelerator pedal or lever position sensor 2 circuit	Voltage below normal, or shorted to low source
1242 91 2	Accelerator pedal or lever position sensor 1	Data erratic, intermittent or incorrect
1358 91 3	Accelerator pedal or lever position sensor 1 circuit	Voltage above normal, or shorted to high source
1359 91 4	Accelerator pedal or lever position sensor 1 circuit	Voltage below normal, or shorted to low source
1515 91 19	SAE J1939 multiplexed accelerator pedal or lever sensor system	Received network data in error
1539 1387 3	Auxiliary pressure sensor input 1 circuit	Voltage above normal, or shorted to high source
1621 1387 4	Auxiliary pressure sensor input 1 circuit	Voltage below normal, or shorted to low source
1668 1761 4	Aftertreatment 1 diesel exhaust fluid tank level sensor circuit	Voltage below normal, or shorted to low source
1669 1761 3	Aftertreatment 1 diesel exhaust fluid tank level sensor circuit	Voltage above normal, or shorted to high source
1673 1761 1	Aftertreatment 1 diesel exhaust fluid tank level	Data valid but below normal operational range -most severe level
1677 3031 4	Aftertreatment 1 diesel exhaust fluid tank temperature sensor	Voltage below normal, or shorted to low source

※ Some fault codes are not applied to this machine.

Fault code J1939 SPN J1939 FMI	Item	Description
1678 3031 3	Aftertreatment 1 diesel exhaust fluid tank temperature sensor	Voltage above normal, or shorted to high source
1679 3031 2	Aftertreatment 1 diesel exhaust fluid tank temperature	Data erratic, intermittent or incorrect
1682 3362 31	Aftertreatment 1 diesel exhaust fluid dosing unit input lines	Condition exists
1685 3364 4	Aftertreatment diesel exhaust fluid quality sensor circuit	Voltage below normal, or shorted to low source
1686 3364 3	Aftertreatment diesel exhaust fluid quality sensor circuit	Voltage above normal, or shorted to high source
1695 3513 3	Sensor supply 5	Voltage above normal, or shorted to high source
1696 3513 4	Sensor supply 5	Voltage below normal, or shorted to low source
1713 3363 16	Aftertreatment 1 diesel exhaust fluid tank heater	Data valid but above normal operating range - moderately severe level
1714 3364 13	Aftertreatment diesel exhaust fluid quality	Out of calibration
1715 3364 11	Aftertreatment diesel exhaust fluid quality	Root cause not known
1843 101 3	Crankcase pressure circuit	Voltage above normal, or shorted to high source
1844 101 4	Crankcase pressure circuit	Voltage below normal, or shorted to low source
1852 97 16	Water in fuel indicator	Data valid but above normal operating range - moderately severe level
1879 3251 3	Aftertreatment diesel particulate filter differential pressure sensor circuit	Voltage above normal
1881 3251 4	Aftertreatment diesel particulate filter differential pressure sensor circuit	Voltage below normal
1883 3251 2	Aftertreatment diesel particulate filter differential pressure sensor	Data erratic, intermittent or incorrect

※ Some fault codes are not applied to this machine.

Fault code J1939 SPN J1939 FMI	Item	Description
1885 3216 4	Aftertreatment 1 intake NOx sensor circuit	Voltage below normal, or shorted to low source
1887 3226 4	Aftertreatment 1 outlet NOx sensor circuit	Voltage below normal, or shorted to low source
1921 3251 16	Aftertreatment diesel particulate filter differential pressure	Data valid but above normal operating range
1922 3251 0	Aftertreatment diesel particulate filter differential pressure	Data valid but above normal operating range
1993 4795 31	Aftertreatment 1 diesel particulate filter missing	Condition exists
2185 3512 3	Sensor supply 4 circuit	Voltage above normal, or shorted to high source
2186 3512 4	Sensor supply 4 circuit	Voltage below normal, or shorted to low source
2311 633 31	Electronic fuel injection control valve circuit	Condition exists
2321 190 2	Engine crankshaft speed/position	Data erratic, intermittent or incorrect
2322 723 2	Engine camshaft speed / position sensor	Data erratic, intermittent or incorrect
2373 1209 3	Exhaust gas pressure sensor 1 circuit	Voltage above normal, or shorted to high source
2374 1209 4	Exhaust gas pressure sensor 1 circuit	Voltage below normal, or shorted to low source
2448 111 17	Coolant level	Data valid but below normal operating range - least severe level
2468 190 16	Engine speed	Engine crankshaft speed/position - data valid but above normal operating range - moderately severe level
2554 1209 2	Exhaust gas pressure 1	Data erratic, intermittent or incorrect
2557 697 3	Auxiliary PWM driver 1 circuit	Voltage above normal, or shorted to high source

※ Some fault codes are not applied to this machine.

Fault code J1939 SPN J1939 FMI	Item	Description
2558 697 4	AuxiliaryPWM driver 1 circuit	Voltage below normal, or shorted to low source
2571 2630 3	Engine charge air cooler outlet temperature	Voltage above normal, or shorted to high source
2572 2630 4	Engine charge air cooler outlet temperature	Voltage below normal, or shorted to low source
2639 3251 15	Aftertreatment diesel particulate filter differential pressure	Data valid but above normal operating range
2765 1209 16	Engine injector group 1	Engine injector bank 1 barcodes - out of calibration
2771 3226 9	Aftertreatment 1 outlet NOx sensor	Abnormal update rate
2778 3481 16	Aftertreatment fuel rate	Data valid but above normal operating range - moderately severe level
2973 102 2	Intake manifold 1 pressure	Data erratic, intermittent or incorrect
2976 3361 2	Aftertreatment 1 diesel exhaust fluid dosing unit temperature	Data erratic, intermittent or incorrect
3133 3610 3	Aftertreatment 1 diesel particulate filter outlet pressure sensor circuit	Voltage above normal, or shorted to high source
3134 3610 4	Aftertreatment 1 diesel particulate filter outlet pressure sensor circuit	Voltage below normal, or shorted to low source
3135 3610 2	Aftertreatment 1 diesel particulate filter outlet pressure	Data erratic, intermittent or incorrect
3139 3667 3	Engine air shutoff circuit	Voltage above normal, or shorted to high source
3141 3667 4	Engine air shutoff circuit	Voltage below normal, or shorted to low source
3142 4360 3	Aftertreatment 1 SCR intake temperature sensor circuit	Voltage above normal, or shorted to high source
3144 4360 2	Aftertreatment 1 SCR intake temperature sensor	Data erratic, intermittent or incorrect

※ Some fault codes are not applied to this machine.

Fault code J1939 SPN J1939 FMI	Item	Description
3146 4363 3	Aftertreatment 1 SCR outlet temperature sensor circuit	Voltage above normal, or shorted to high source
3147 4363 4	Aftertreatment 1 SCR outlet temperature sensor circuit	Voltage below normal, or shorted to low source
3148 4363 2	Aftertreatment 1 SCR outlet temperature sensor	Data erratic, intermittent or incorrect
3151 4974 31	Aftertreatment 1 SCR catalyst system missing	Condition exists
3165 4363 0	Aftertreatment 1 SCR outlet temperature	Data valid but above normal operational range - most severe
3232 3216 9	Aftertreatment 1 intake NOx sensor	Abnormal update rate
3235 4363 16	Aftertreatment 1 SCR outlet temperature	Data valid but above normal operating range - moderately severe level
3251 4765 16	Aftertreatment 1 diesel oxidation catalyst intake temperature	Data valid but above normal operating range
3253 3242 16	Aftertreatment 1 diesel particulate filter intake temperature	Data valid but above normal operating range
3254 3242 16	Aftertreatment 1 diesel particulate filter intake temperature	Data valid but above normal operating range
3255 3246 16	Aftertreatment 1 diesel particulate filter outlet temperature	Data valid but above normal operating range
3311 3242 0	Aftertreatment 1 diesel particulate filter intake temperature	Data valid but above normal operation
3312 3246 0	Aftertreatment 1 diesel particulate filter outlet temperature	Data valid but above normal operation
3313 4765 4	Aftertreatment 1 diesel oxidation catalyst intake temperature sensor circuit	Voltage below normal, or shorted to low source
3314 4765 3	Aftertreatment 1 diesel oxidation catalyst intake temperature sensor circuit	Voltage above normal, or shorted to high source
3315 4765 2	Aftertreatment 1 diesel oxidation catalyst intake temperature	Data erratic, intermittent or incorrect

※ Some fault codes are not applied to this machine.

Fault code J1939 SPN J1939 FMI	Item	Description
3316 3242 4	Aftertreatment 1 diesel particulate filter intake temperature sensor circuit	Voltage below normal, or shorted to low source
3317 3242 3	Aftertreatment 1 diesel particulate filter intake temperature sensor circuit	Voltage above normal, or shorted to high source
3318 3242 2	Aftertreatment 1 diesel particulate filter intake temperature	Data erratic, intermittent or incorrect
3319 3246 3	Aftertreatment 1 diesel particulate filter outlet temperature sensor circuit	Voltage above normal, or shorted to high source
3321 3246 4	Aftertreatment 1 diesel particulate filter outlet temperature sensor circuit	Voltage below normal, or shorted to low source
3322 3246 2	Aftertreatment 1 diesel particulate filter outlet temperature	Data erratic, intermittent or incorrect
3326 91 9	SAE J1939 multiplexed accelerator pedal or lever sensor system	Abnormal update rate
3341 107 16	Engine air filter differential pressure - data valid but above normal operating range	Moderately severe level
3375 5397 31	Aftertreatment diesel particulate filter regeneration too frequent	Condition exists
3376 5319 31	Aftertreatment diesel particulate filter incomplete regeneration	Condition exists
3497 1761 17	Aftertreatment 1 diesel exhaust fluid tank level	Data valid but below normal operating range - least severe level
3498 1761 18	Aftertreatment 1 diesel exhaust fluid tank level	Data valid but below normal operating range - moderately severe level
3527 558 19	Accelerator pedal or lever idle validation switch	Received network data in error
3528 558 9	Accelerator pedal or lever idle validation switch	Abnormal update rate
3545 3226 31	Aftertreatment 1 outlet NOx sensor	Abnormal rate of change
3547 4096 31	Aftertreatment diesel exhaust fluid tank empty	Condition exists

※ Some fault codes are not applied to this machine.

Fault code J1939 SPN J1939 FMI	Item	Description
3558 3361 3	Aftertreatment 1 diesel exhaust fluid dosing unit	Voltage above normal, or shorted to high source
3559 3361 4	Aftertreatment 1 diesel exhaust fluid dosing unit	Voltage below normal, or shorted to low source
3567 5394 5	Aftertreatment diesel exhaust fluid dosing valve	Current below normal or open circuit
3568 5394 7	Aftertreatment diesel exhaust fluid dosing valve	Mechanical system not responding or out of adjustment
3571 4334 3	Aftertreatment 1 diesel exhaust fluid pressure sensor	Voltage above normal, or shorted to high source
3572 4334 4	Aftertreatment 1 diesel exhaust fluid pressure sensor	Voltage below normal, or shorted to low source
3574 4334 18	Aftertreatment 1 diesel exhaust fluid pressure sensor	Data valid but below normal operating range
3575 4334 16	Aftertreatment 1 diesel exhaust fluid pressure sensor	Data valid but above normal operating range
3577 4376 3	Aftertreatment diesel exhaust fluid return valve	Voltage above normal, or shorted to high source
3578 4376 4	Aftertreatment diesel exhaust fluid return valve	Voltage above normal, or shorted to low source
3583 5031 10	Aftertreatment 1 outlet nox sensor heater	Abnormal rate of change
3596 4334 2	Aftertreatment 1 diesel exhaust fluid pressure sensor	Data erratic, intermittent or incorrect
3641 748 9	Transmission output retarder	Abnormal update rate
3649 5024 10	Aftertreatment 1 intake NOx sensor heater	Abnormal rate of change
3681 3228 2	Aftertreatment 1 outlet NOx sensor power supply	Data erratic, intermittent or incorrect
3682 3218 2	Aftertreatment 1 intake NOx sensor power supply	Data erratic, intermittent or incorrect

※ Some fault codes are not applied to this machine.

Fault code J1939 SPN J1939 FMI	Item	Description
3697 630 12	Engine control module calibration memory	Bad intelligent device or component
3712 5246 0	Aftertreatment SCR operator inducement	Data valid but above normal operational range - most severe level
3714 1569 31	Engine protection torque derate	Condition exists
3725 3216 10	Aftertreatment 1 intake NOx sensor	Abnormal rate of change
3727 5571 7	High pressure common rail fuel pressure relief valve	Mechanical system not responding or out of adjustment
3737 1675 31	Engine starter mode overcrank protection	Condition exists
3741 5571 0	High pressure common rail fuel pressure relief valve	Data valid but above normal operational range
3748 3216 20	Aftertreatment 1 intake NOx sensor	Data not rational - drifted high
3765 442 3	Auxiliary temperature sensor input 2 circuit	Voltage above normal, or shorted to high source
3766 442 4	Auxiliary temperature sensor input 2 circuit	Voltage below normal, or shorted to low source
3838 2978 9	Estimated engine parasitic losses - percent torque	Abnormal update rate
3841 596 2	Cruise control enable switch	Data erratic, intermittent or incorrect
3843 5603 9	Cruise control disable command	Abnormal update rate
3845 5603 31	Cruise control disable command	Condition exists
3866 3364 1	Aftertreatment diesel exhaust fluid quality	Data valid but below normal operational range - most severe level
3868 3364 9	Aftertreatment diesel exhaust fluid quality	Abnormal update rate

※ Some fault codes are not applied to this machine.

Fault code J1939 SPN J1939 FMI	Item	Description
3878 3364 2	Aftertreatment diesel exhaust fluid quality	Data erratic, intermittent or incorrect
4151 5742 9	Aftertreatment diesel particulate filter temperature sensor module	Abnormal update rate
4152 5743 9	Aftertreatment selective catalytic reduction temperature sensor module	Abnormal update rate
4156 5746 4	Aftertreatment 1 diesel exhaust fluid dosing unit heater relay	Voltage below normal, or shorted to low source
4158 5742 12	Aftertreatment diesel particulate filter temperature sensor module	Bad intelligent device or component
4159 5743 12	Aftertreatment selective catalytic reduction temperature sensor module	Bad intelligent device or component
4161 5742 3	Aftertreatment diesel particulate filter temperature sensor module	Voltage above normal, or shorted to high source
4162 5742 4	Aftertreatment diesel particulate filter temperature sensor module	Voltage below normal, or shorted to low source
4163 5742 16	Aftertreatment diesel particulate filter temperature sensor module	Data valid but above normal operating range
4164 5743 3	Aftertreatment selective catalytic reduction temperature sensor module	Voltage above normal, or shorted to high source
4165 5743 4	Aftertreatment selective catalytic reduction temperature sensor module	Voltage below normal, or shorted to low source
4166 5743 16	Aftertreatment selective catalytic reduction temperature sensor module	Data valid but above normal
4168 5745 3	Aftertreatment 1 diesel exhaust fluid dosing unit heater	Voltage above normal, or shorted to high source
4169 5745 4	Aftertreatment 1 diesel exhaust fluid dosing unit heater	Voltage below normal, or shorted to low source
4249 4337 10	Aftertreatment 1 diesel exhaust fluid dosing temperature	Abnormal rate of change
4251 5798 10	Aftertreatment 1 diesel exhaust fluid dosing unit heater temperature	Abnormal rate of change

※ Some fault codes are not applied to this machine.

Fault code J1939 SPN J1939 FMI	Item	Description
4259 5742 11	Aftertreatment diesel particulate filter temperature sensor module	Root cause not known
4261 5743 11	Aftertreatment selective catalytic reduction temperature sensor module	Root cause not known
4277 3364 10	Aftertreatment diesel exhaust fluid quality	Abnormal rate of change
4284 5793 9	Desired engine fueling state	Abnormal update rate
4452 3226 7	Aftertreatment 1 outlet NOx sensor closed loop operation	Condition exists
4484 3667 7	Engine air shutoff	Mechanical system not responding or out of Adjustment
4526 521 2	Brake pedal position	Data erratic, intermittent or incorrect
4572 3031 9	Aftertreatment 1 diesel exhaust fluid tank temperature	Abnormal update rate
4584 3936 14	Aftertreatment diesel particulate filter system	Special instructions
4585 4792 14	Aftertreatment 1 SCR catalyst system	Special instructions
4677 1761 9	SAE J1939 multiplexing pgn timeout error	Abnormal update rate
4724 702 5	Auxiliary input/output 2 circuit	Current below normal or open circuit
4725 702 6	Auxiliary input/output 2 circuit	Current above normal or grounded circuit
4731 3031 13	Aftertreatment 1 diesel exhaust fluid tank temperature sensor	Out of calibration
4734 701 14	Auxiliary input/output 1	Special instructions
4737 3031 11	Aftertreatment 1 diesel exhaust fluid tank temperature	Root cause not known

※ Some fault codes are not applied to this machine.

Fault code J1939 SPN J1939 FMI	Item	Description
4739 1761 11	Aftertreatment 1 diesel exhaust fluid tank level sensor	Root cause not known
4747 3217 20	Aftertreatment intake oxygen sensor	Data not rational - drifted high
4748 3217 21	Aftertreatment intake oxygen sensor	Data not rational - drifted low
4749 3227 20	Aftertreatment outlet oxygen	Data not rational - drifted high
4751 3227 21	Aftertreatment outlet oxygen	Data not rational - drifted low
4768 3521 11	Aftertreatment 1 diesel exhaust fluid property	Root cause not known
4769 1761 10	Aftertreatment 1 diesel exhaust fluid tank level sensor	Abnormal rate of change
4842 3364 15	Aftertreatment diesel exhaust fluid quality	Data valid but above normal operating range - Least severe level
4863 5245 31	Aftertreatment diesel exhaust fluid tank low level indicator	-
4953 3353 3	Alternator 1 status	Voltage above normal, or shorted to high source
4954 3353 4	Alternator 1 status	Voltage below normal, or shorted to low source
5248 1623 13	Tachograph output shaft speed	Out of calibration
5272 649 4	Engine exhaust back pressure regulator control circuit	Voltage below normal, or shorted to low source
5273 649 5	Engine exhaust back pressure regulator control circuit	Current below normal or open circuit
5274 5625 2	Engine exhaust back pressure regulator position	Data erratic, intermittent or incorrect
5275 5625 3	Engine exhaust back pressure regulator position sensor circuit	Voltage above normal, or shorted to high source

※ Some fault codes are not applied to this machine.

Fault code J1939 SPN J1939 FMI	Item	Description
5276 5625 4	Engine exhaust back pressure regulator position sensor circuit	Voltage above normal, or shorted to low source
5292 520809 31	Excessive time since last engine air shutoff maintenance test	Condition exists
5383 3720 15	Aftertreatment 1 diesel particulate filter ash load percent	Data valid but above normal operating range - least severe level
5576 107 15	Engine air filter differential pressure	Data valid but above normal operating range - least severe level
5632 6918 31	SCR system cleaning inhibited due to inhibit switch	Condition exists
5652 1209 15	Exhaust pressure 1	Data valid but above normal operating range - least severe level
5653 6881 9	SCR operator inducement override switch	Abnormal update rate
5654 6881 13	SCR operator inducement override switch	Out of calibration
5655 4364 31	Aftertreatment 1 scr conversion efficiency	Condition exists
5689 3226 11	Aftertreatment 1 outlet nox sensor	Root cause not known
5715 3521 10	Aftertreatment 1 diesel particulate filter differential pressure	Abnormal rate of change
5716 3610 10	Aftertreatment 1 diesel particulate filter outlet pressure	Abnormal rate of change
5864 4375 3	Aftertreatment 1 diesel exhaust fluid pump command circuit	Voltage above normal or shorted to high source
5865 4375 4	Aftertreatment 1 diesel exhaust fluid pump command circuit	Voltage below normal or shorted to low source
5868 4339 7	Aftertreatment 1 scr feedback control status	Mechanical system not responding or out of adjustment
5935 4334 7	Aftertreatment 1 diesel exhaust fluid pressure	Mechanical system not responding or out of adjustment

※ Some fault codes are not applied to this machine.

Fault code J1939 SPN J1939 FMI	Item	Description
5936 4334 15	Aftertreatment 1 diesel exhaust fluid pressure	Data valid but above normal operating range - least severe level
5938 3750 14	Aftertreatment 1 diesel particulate filter conditions not met for active regeneration	Special instructions
5939 520968 9	Machine constrained operation	Abnormal update rate. No communication or an Invalid data transfer rate has been detected on the J1939 data link between the ECM and the machine
5941 520968 19	Machine constrained operation	Received network data in error. The received J1939 datalink message was not valid.
6256 168 15	Battery 1 voltage	Data valid but below normal operating range - moderately severe level
6257 168 17	Battery 1 voltage	Data valid but below normal operating range - moderately severe level
6263 647 3	Fan control circuit	Voltage above normal, or shorted to high source
6264 647 4	Fan control circuit	Voltage below normal, or shorted to low source
6456 5484 3	Engine fan clutch 2 control circuit	Voltage above normal, or shorted to high source
6457 5484 4	Engine fan clutch 2 control circuit	Voltage below normal, or shorted to low source
6467 1639 15	Fan speed	Data valid but above normal operational range - most severe level
6468 1639 17	Fan speed	Data valid but below normal operational range - most severe level
6471 6799 3	Fan blade pitch position sensor circuit	Voltage above normal, or shorted to high source
6472 6799 4	Fan blade pitch position sensor circuit	Voltage below normal, or shorted to low source
6475 3363 7	Aftertreatment 1 diesel exhaust fluid tank heater	Mechanical system not responding or out of adjustment
6476 3363 18	Aftertreatment 1 diesel exhaust fluid tank heater	Data valid but below normal operating range - moderately severe level

※ Some fault codes are not applied to this machine.

Fault code J1939 SPN J1939 FMI	Item	Description
6477 5491 3	Aftertreatment diesel exhaust fluid line heater relay	Voltage above normal, or shorted to high source
6478 5491 4	Aftertreatment diesel exhaust fluid line heater relay	Voltage below normal, or shorted to low source
6479 3363 3	Aftertreatment 1 diesel exhaust fluid tank heater	Voltage above normal, or shorted to high source
6481 3363 4	Aftertreatment 1 diesel exhaust fluid tank heater	Voltage below normal, or shorted to low source
6511 6655 3	Maintain ECM power lamp	Voltage above normal, or shorted to high source
6512 6655 4	Maintain ECM power lamp	Voltage below normal, or shorted to low source
6513 5745 17	Aftertreatment 1 diesel exhaust fluid dosing unit heater	Data valid but below normal operating range
6522 111 3	Coolant level sensor 1 circuit	Voltage above normal, or shorted to high source
6523 111 4	Coolant level sensor 1 circuit	Voltage below normal, or shorted to low source
6526 1761 13	Aftertreatment 1 diesel exhaust fluid tank level sensor	Out of calibration
6527 4376 7	Aftertreatment diesel exhaust fluid return valve	Mechanical system not responding or out of adjust
6529 5746 3	Aftertreatment 1 diesel exhaust fluid dosing unit heater relay	Voltage above normal, or shorted to high source
6531 4340 3	Aftertreatment 1 diesel exhaust fluid line heater 1 circuit	Voltage above normal, or shorted to high source
6532 4340 4	Aftertreatment 1 diesel exhaust fluid line heater 1 circuit	Voltage below normal, or shorted to low source
6533 4342 3	Aftertreatment 1 diesel exhaust fluid line heater 2 circuit	Voltage above normal, or shorted to high source
6534 4342 4	Aftertreatment 1 diesel exhaust fluid line heater 2 circuit	Voltage below normal, or shorted to low source

※ Some fault codes are not applied to this machine.

Fault code J1939 SPN J1939 FMI	Item	Description
6535 4344 3	Aftertreatment diesel exhaust fluid line heater 3 circuit	Voltage above normal, or shorted to high source
6536 4344 4	Aftertreatment diesel exhaust fluid line heater 3 circuit	Voltage below normal, or shorted to low source
6556 729 3	Engine intake air heater 1 circuit	Voltage above normal, or shorted to high source
6557 729 4	Engine intake air heater 1 circuit	Voltage below normal, or shorted to low source
6563 976 2	Auxiliary intermediate (PTO) speed switch validation	Data erratic, intermittent or incorrect
6568 3695 2	Aftertreatment regeneration inhibit switch	Data erratic, intermittent or incorrect
6583 441 14	Auxiliary temperature sensor input 1	Special instructions
6584 1388 14	Auxiliary pressure sensor input 2	Special instructions
6595 190 11	Engine speed	Root cause not known
6596 3713 31	Diesel particulate filter active regeneration inhibited due to system timeout	Condition exists
6599 521002 31	Engine cranks slowly	Condition exists
6611 6385 3	Engine starter motor relay control circuit	Voltage above normal or shorted to high source
6612 6385 4	Engine starter motor relay control circuit	Voltage below normal or shorted to low source
6613 5842 14	SCR monitoring system malfunction	Special instructions
6618 70 2	Parking brake switch	Data erratic, intermittent, or incorrect
6619 3515 10	Aftertreatment 1 diesel exhaust fluid temperature 2	Abnormal rate of change

※ Some fault codes are not applied to this machine.

Fault code J1939 SPN J1939 FMI	Item	Description
6654 5626 7	Engine exhaust back pressure regulator	Mechanical system not responding or out of adjustment
6726 4796 31	Aftertreatment 1 diesel oxidation catalyst missing	Condition exists
6752 3364 18	Aftertreatment diesel exhaust fluid quality	Data valid but below normal operating range - moderately severe level
6771 521032 14	Aftertreatment system assembly	Special instructions
6938 5793 9	Desired engine fueling state	Abnormal update rate
6939 7745 9	Engine start request	Abnormal update rate
7133 7745 13	Engine start request	Out of calibration
7134 7746 13	Engine start consent	Out of calibration
7135 103 15	Engine turbocharger speed	Data valid but above normal operating range - least severe level
7745 1569 14	Engine protection torque derate	Special instructions
7393 7745 9	Engine start request	Abnormal update rate
7453 3242 15	Aftertreatment 1 diesel particulate filter intake temperature	Data valid but above normal operating range - least severe level
7454 3246 15	Aftertreatment 1 diesel particulate filter outlet temperature	Data valid but above normal operating range - least severe level

※ Some fault codes are not applied to this machine.

GROUP 13 ENGINE CONTROL SYSTEM

1. MCU AND ENGINE ECM

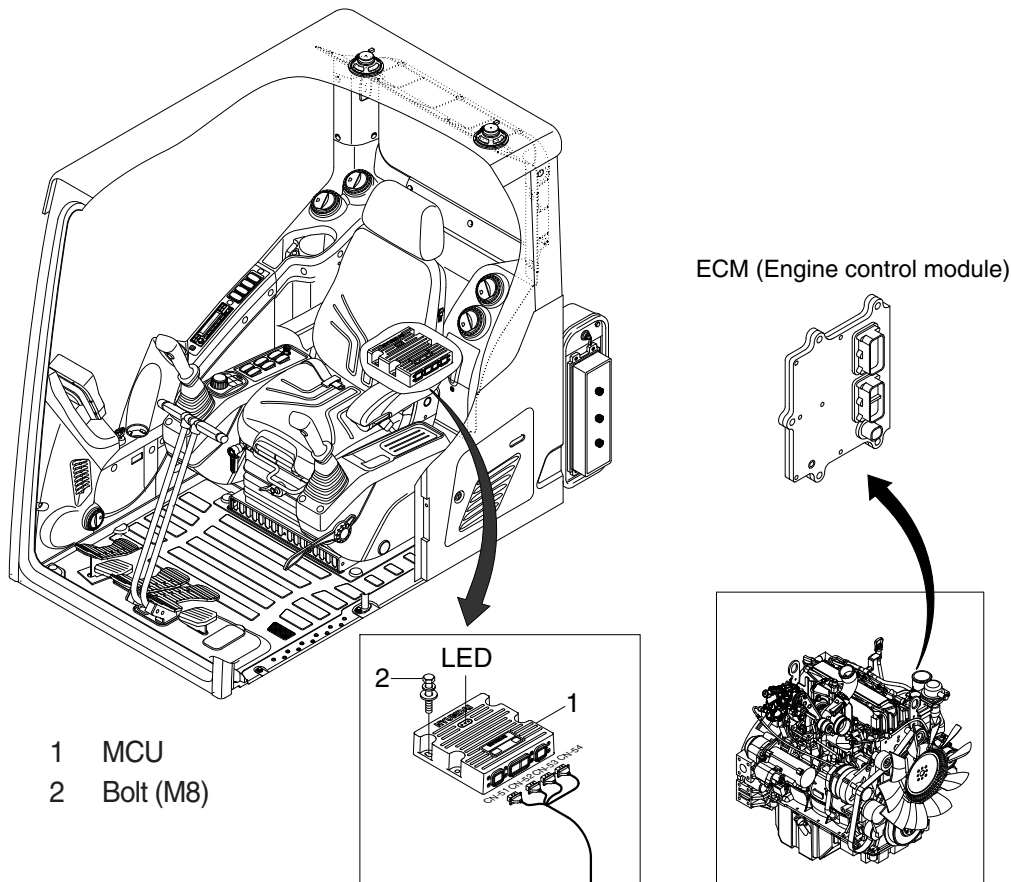

2. MCU ASSEMBLY

1) To match the pump absorption torque with the engine torque, MCU varies EPPR valve output pressure, which control pump discharge amount whenever feedbacked engine speed drops under the reference rpm of each mode set.

2) Three LED lamps on the MCU display as below.

LED lamp	Trouble	Service
G is turned ON	Normal	-
G and R are turned ON	Trouble on MCU	· Change the MCU
G and Y are turned ON	Trouble on serial communication line	· Check if serial communication lines between MCU and cluster are disconnected
Three LED are turned OFF	Trouble on MCU power	· Check if the input power wire (24 V, GND) of MCU is disconnected · Check the fuse

G : green, R : red, Y : yellow

GROUP 14 EPPR VALVE

1. PUMP EPPR VALVE

1) COMPOSITION

EPPR (Electro Proportional Pressure Reducing) valve consists of electro magnet and spool valve installed at main pump.

(1) Electro magnet valve

Receive electric current from MCU and move the spool proportionally according to the specific amount of electric current value.

(2) Spool valve

Is the two way direction control valve for pilot pressure to reduce main pump flow.

When the electro magnet valve is activated, pilot pressure enters into flow regulator of main pump.

2) OPERATING PRINCIPLE (pump EPPR valve)

(1) Structure

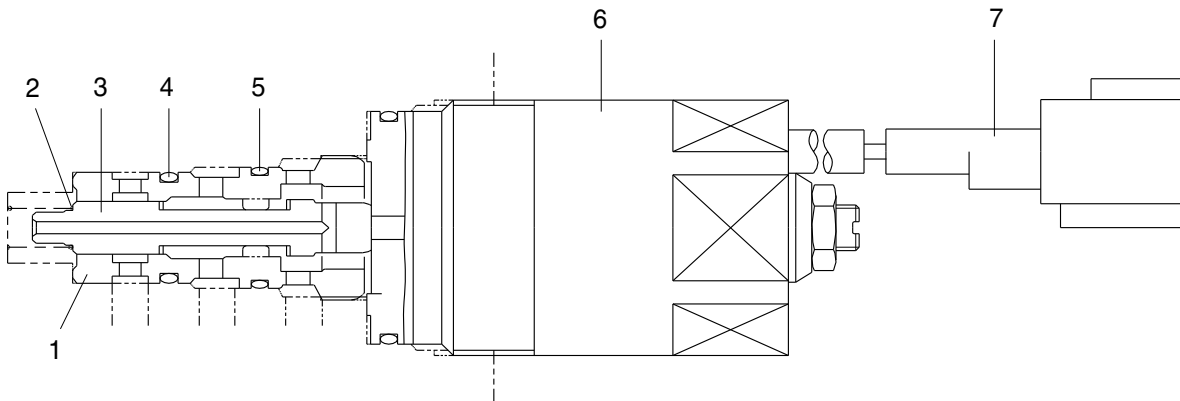

5-22(1)

- 1 Sleeve
- 2 Spring
- 3 Spool

- 4 O-ring
- 5 O-ring

- 6 Solenoid valve
- 7 Connector

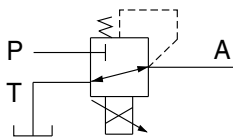

P Pilot oil supply line (pilot pressure)

T Return to tank

A Secondary pressure to flow regulator at main pump

(2) Neutral

Pressure line is blocked and A oil returns to tank.

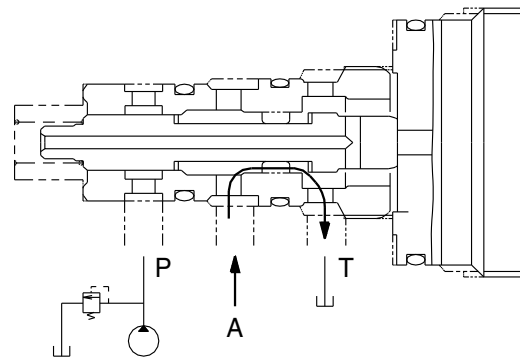
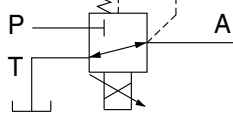

(3) Operating

Secondary pressure enters into A.

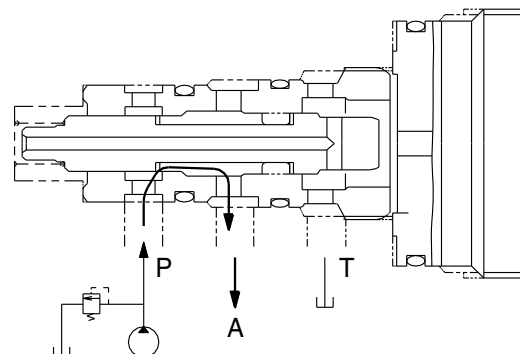
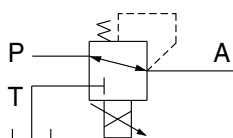

5-22(2)

3) EPPR VALVE CHECK PROCEDURE

(1) Check electric current value at EPPR valve

- ① Disconnect connector CN-75 from EPPR valve.
- ② Insert the adapter to CN-75 and install multimeter as figure.
- ③ Start engine.
- ④ Set S-mode and cancel auto decel mode.
- ⑤ Position the multimodal dial at 10.
- ⑥ If rpm display show approx 1750 ± 50 rpm check electric current at bucket circuit relief position.
- ⑦ Check electric current at bucket circuit relief position.

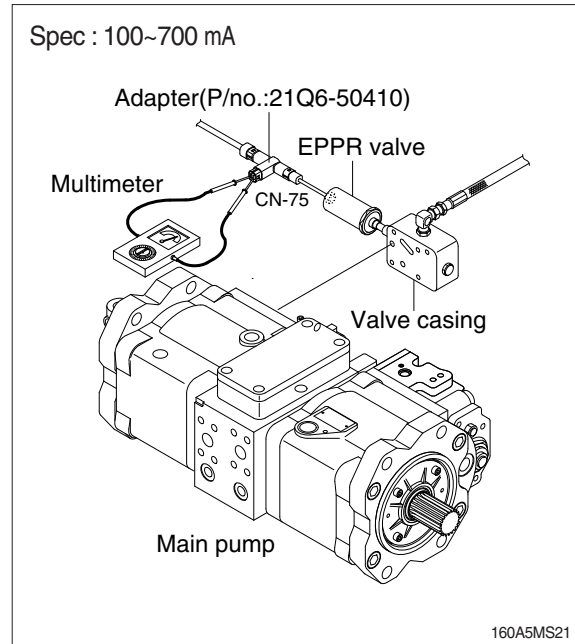

(2) Check pressure at EPPR valve

- ① Start engine.
- ② Set S-mode and cancel auto decel mode.
- ③ Position the multimodal dial at 10.
- ④ Slowly operate control lever of bucket functions at full stroke over relief and measure the EPPR valve pressure by the the monitoring menu of the cluster.
- ⑤ If pressure is not correct, adjust it.
- ⑥ After adjust, test the machine.

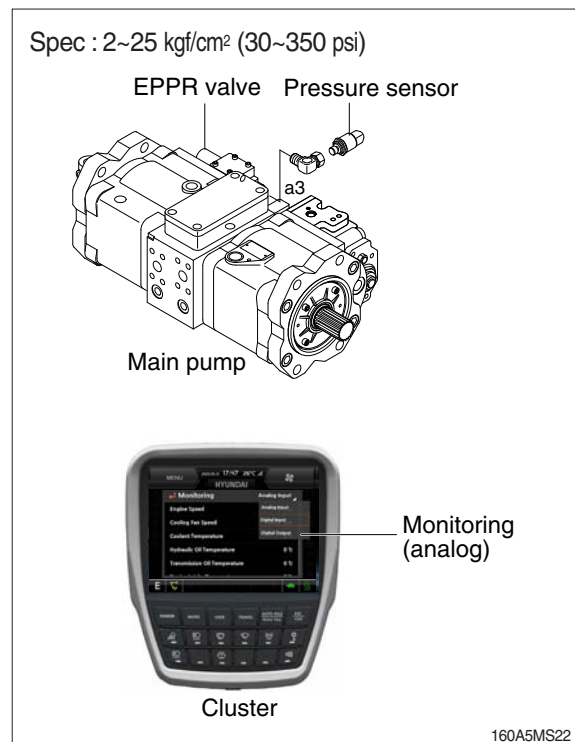

2. BOOM PRIORITY EPPR VALVE

1) COMPOSITION

The boom priority EPPR valve is built in a manifold and mainly consisting of valve body and coil. This EPPR valve installed under the solenoid valve.

2) CONTROL

The boom priority EPPR valve has to be controlled by a specific electronic amplifier card, which is supplying the coil with a current 580 mA at 30Ω and 24 V.

3) OPERATING PRINCIPLE

(1) Structure

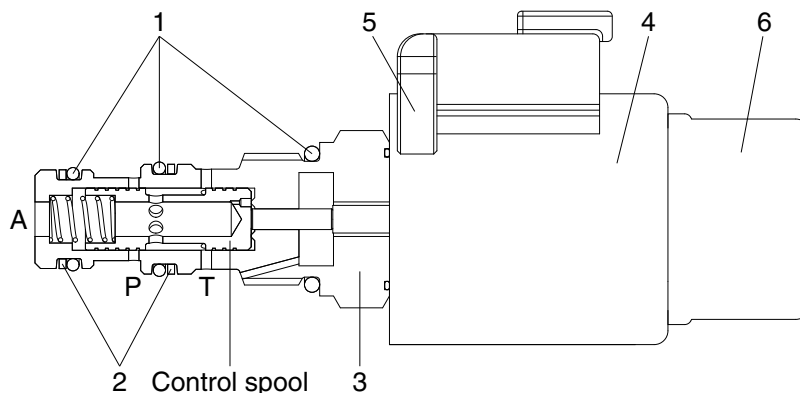

21095MS14

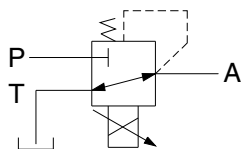

P : Pilot supply line
T : Return to tank
A : Secondary pressure to flow MCV

- | | | |
|----------------|--------------|-------------|
| 1 O-ring | 3 Valve body | 5 Connector |
| 2 Support ring | 4 Coil | 6 Cover cap |

(2) Operation

In de-energized mode the inlet port (P) is closed and the outlet port (A) is connected to tank port (T).

In energized mode the solenoid armature presses onto the control spool with a force corresponding to the amount of current. This will set a reduced pressure at port A. The setting is proportional to the amount of current applied.

(3) Maximum pressure relief

If a pressure from outside is applied on port A the valve may directly switch to tank port (T) and protect the system before overload.

4) EPPR VALVE CHECK PROCEDURE

(1) Check electric current value at EPPR valve

- ① Disconnect connector CN-133 from EPPR valve.
- ② Insert the adapter to CN-133 and install multimeter as figure.
- ③ Start engine.
- ④ Set S-mode and cancel auto decel mode.
- ⑤ If rpm display approx 1750 ± 50 rpm disconnect one wire harness from EPPR valve.
- ⑥ Check electric current in case of combined boom up and swing operation.

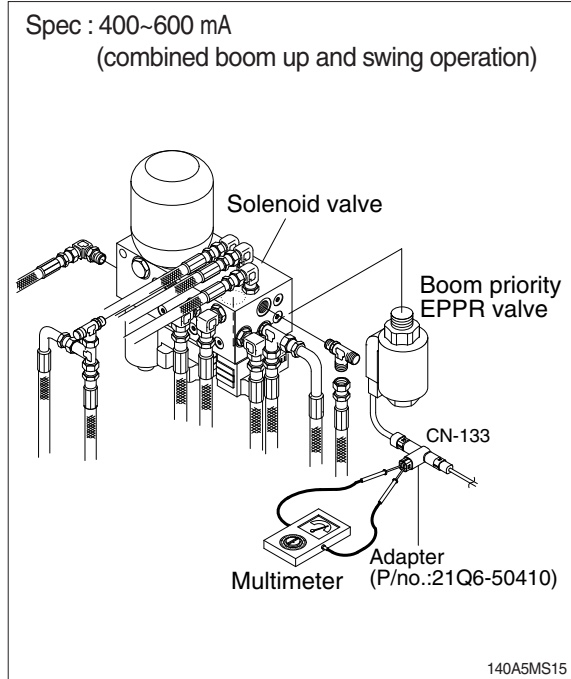

(2) Check pressure at EPPR valve

- ① Remove hose from A5 port and connect pressure gauge as figure.
 - Gauge capacity : 0 to 50 kgf/cm²
(0 to 725 psi)
- ② Start engine.
- ③ Set S-mode and cancel auto decel mode.
- ④ If rpm display approx 1750 ± 50 rpm check pressure (In case of combined boom up and swing operation).
- ⑤ If pressure is not correct, adjust it.
- ⑥ After adjust, test the machine.

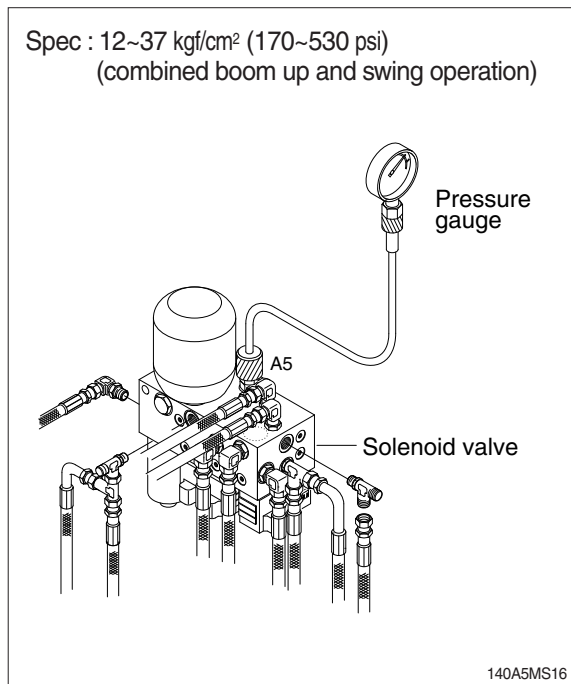

GROUP 15 MONITORING SYSTEM

1. OUTLINE

Monitoring system consists of the monitor part and switch part.

The monitor part gives warnings when any abnormality occurs in the machine and informs the condition of the machine.

Various select switches are built into the monitor panel, which act as the control portion of the machine control system.

2. CLUSTER

1) MONITOR PANEL



160A5CD20

※ The warning lamp pops up and/or blinks and the buzzer sounds when the machine has a problem.

The warning lamp blinks until the problem is cleared. Refer to page 5-73 for details.

※ This cluster is adjustable.

- Vertical (forward/backward) : each 15°
- Horizontal (left only) : 8°

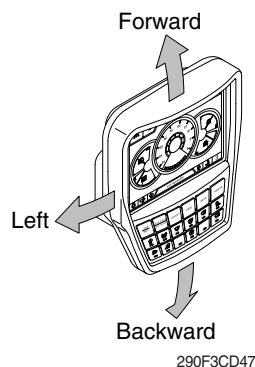

2) CLUSTER CHECK PROCEDURE

(1) Start key : ON

① Check monitor

- a. Buzzer sounding for 4 seconds with HYUNDAI logo on cluster.
- ※ If the ESL mode is set to the enable, enter the password to start engine.

② After initialization of cluster, the operating screen is displayed on the LCD.

Also, self diagnostic function is carried out.

- a. Engine rpm display : 0 rpm
- b. Engine coolant temperature gauge : White range
- c. Hydraulic oil temperature gauge : White range
- d. Fuel level gauge : White range

③ Indicating lamp state

- a. Power mode pilot lamp : E mode or U mode
- b. Work mode pilot lamp : General operation mode (bucket)
- c. Travel speed pilot lamp : Low (turtle)

(2) Start of engine

① Check machine condition

- a. RPM display indicates at present rpm
- b. Gauge and warning lamp : Indicate at present condition.
- ※ When normal condition : All warning lamp OFF
- c. Work mode selection : General work
- d. Power mode selection : E mode or U mode
- e. Travel speed pilot lamp : Low (turtle)

② When warming up operation

- a. Warming up pilot lamp : ON
- b. After engine started, engine speed increases 1200 rpm.
- ※ Others same as above.

③ When abnormal condition

- a. The warning lamp lights up and the buzzer sounds.
- b. If BUZZER STOP switch is pressed, buzzer sound is canceled but the lamp warning lights up until normal condition.
- ※ The pop-up warning lamp moves to the original position and blink when the buzzer stop switch is pushed. Also the buzzer stops.

3) CLUSTER CONNECTOR

(1) CN-56A

No.	Name	Signal
1	Battery 24V	20~32V
2	Power IG (24V)	20~32V
3	GND	-
4	CAN 1 (H)	0~5V
5	CAN 1 (L)	0~5V
6	CAN 2 (H)	0~5V
7	CAN 2 (L)	20~32V
8	NC	-
9	NC	-
10	Aux left	0~5V
11	Aux right	0~5V
12	Aux GND	-

(2) CN-56B

No.	Name	Signal
1	CAM 6.5V	6.3~6.7V
2	CAM GND	-
3	CAM DIFF (H)	0~5V
4	CAM DIFF (L)	0~5V
5	CAM 1	NTSC signal
6	CAM 2	NTSC signal
7	CAM 3	NTSC signal
8	CAM shield	0~5V

NTSC : National Television System Committee

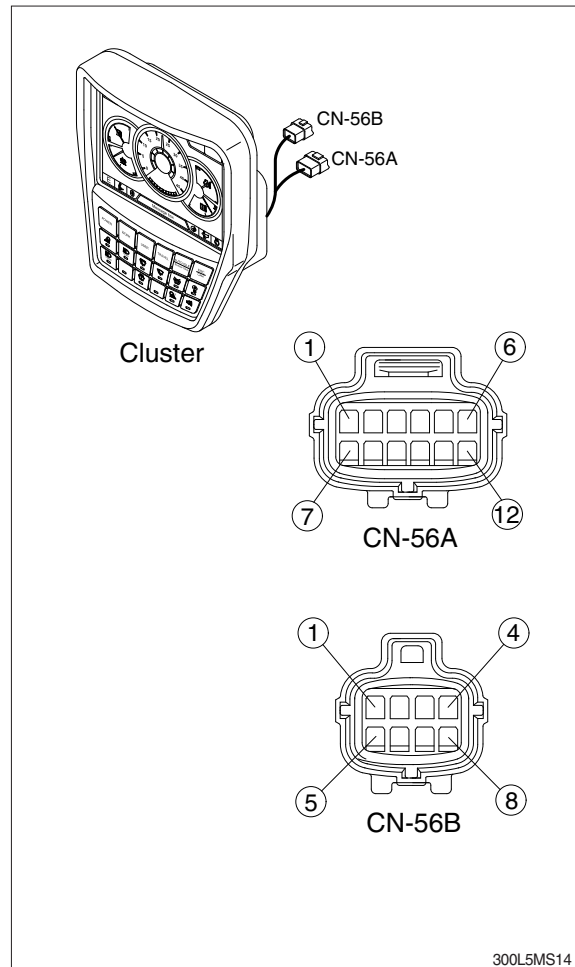

4) GAUGE

(1) Operation screen

When you first turn starting switch ON, the operation screen will appear.



300A3CD21A

- | | | | |
|---|----------------------------------|---|-------------------------|
| 1 | RPM / Speed gauge | 5 | DEF/AdBlue® level gauge |
| 2 | Engine coolant temperature gauge | 6 | Tripmeter display |
| 3 | Hydraulic oil temperature gauge | 7 | Eco gauge |
| 4 | Fuel level gauge | 8 | Accel dial gauge |

(2) RPM / Speed gauge





300A3CD22

- ① This displays the engine speed.

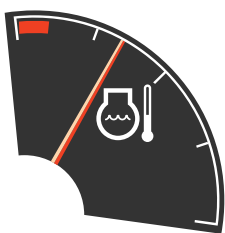
(3) Engine coolant temperature gauge





290F3CD53

- ① This gauge indicates the temperature of coolant.
- White range : 40-107°C (104-225°F)
 - Red range : Above 107°C (225°F)
- ② If the indicator is in the red range or  lamp pops up and the buzzer sounds, turn OFF the engine and check the engine cooling system.
- ※ If the gauge indicates the red range or  lamp blinks in red even though the machine is in the normal condition range, check the electric device as this can be caused by poor connection of sensor.

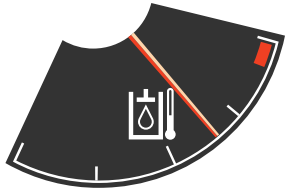
(4) Hydraulic oil temperature gauge





290F3CD54

- ① This gauge indicates the temperature of hydraulic oil.
 - White range : 40-105°C (104-221°F)
 - Red range : Above 105°C (221°F)
 - ② If the indicator is in the red range or  lamp pops up and the buzzer sounds reduce the load on the system. If the gauge stays in the red range, stop the machine and check the cause of the problem.
- ※ If the gauge indicates the red range or  lamp blinks in red even though the machine is in the normal condition range, check the electric device as this can be caused by poor connection of electricity or sensor.

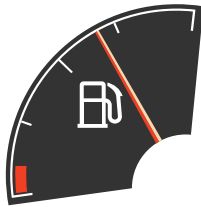
(5) Fuel level gauge





290F3CD55

- ① This gauge indicates the amount of fuel in the fuel tank.
 - ② Fill the fuel when in the red range, or  lamp pops up and the buzzer sounds.
- ※ If the gauge indicates the red range or  lamp blinks in red even though the machine is on the normal condition range, check the electric device as this can be caused by poor connection of electricity or sensor.

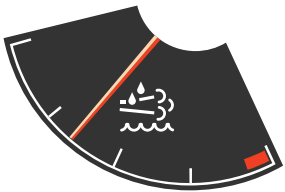
(6) DEF/AdBlue® Level gauge



290F3CD57

- ① This gauge indicates the amount of liquid in the DEF/AdBlue® tank.
 - ② Fill the DEF/AdBlue® when in the red range, or  lamp pops up and the buzzer sounds.
 - ③ Do not overfull DEF/AdBlue®.
- ※ Refer to page 5-78.
- ※ If the gauge indicates the red range or  lamp blinks in red even though the machine is in the normal condition range, check the electric device as this can be caused by poor connection of electricity or sensor.

(7) Tripmeter display

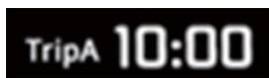

290F3CD56

- ① This displays the engine the tripmeter.
- ※ Refer to page 5-103 for details.

(8) Eco gauge



290F3CD58

- ① This gauge indicates the fuel consumption rate and machine load status so that the operators can operate the machine efficient in regards to fuel consumption.
- ② Fuel consumption rate or machine load is higher if the number of segments are increased.
- ③ The color of Eco gauge indicates operation status.
 - White : Idle operation
 - Green : Economy operation
 - Yellow : Non-economy operation at a medium level.
 - Red : Non-economy operation at a high level.

(9) Accel dial gauge



290F3CD59





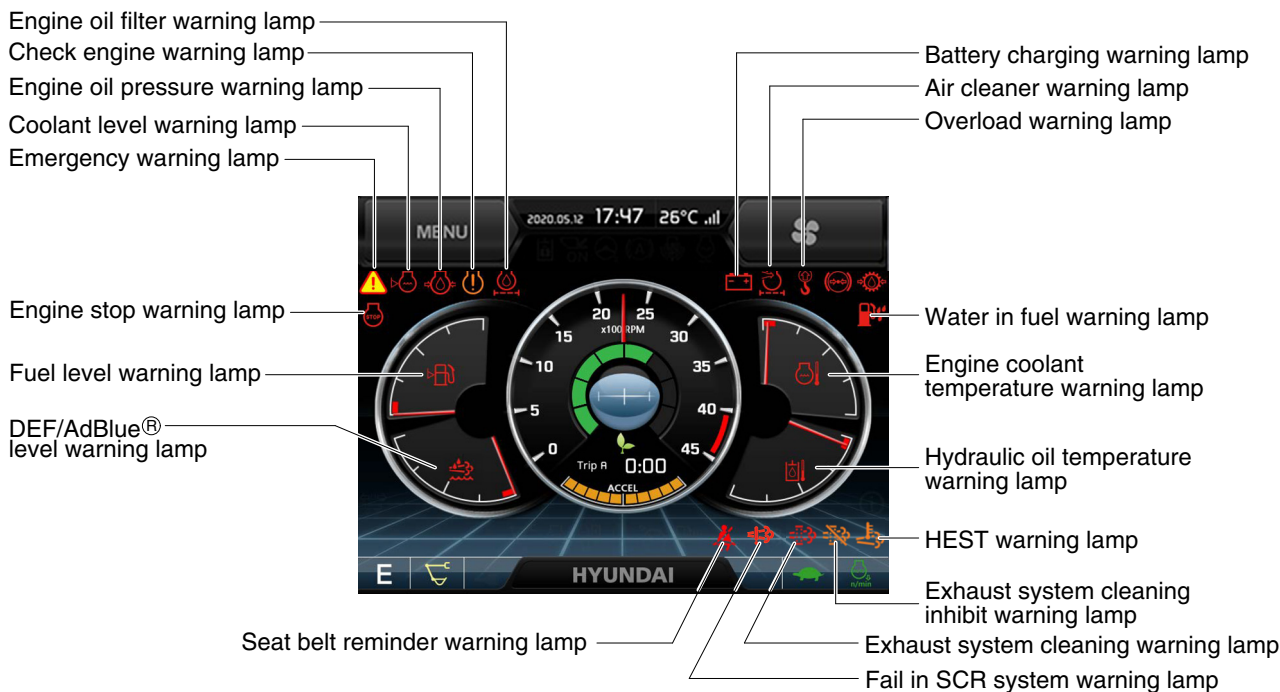



- ① This gauge indicates the level of accel dial.

5) WARNING LAMPS



300A3CD23B

※ Warning lamps and buzzer







Warnings	When error happened	Lamps and buzzer
All warning lamps except below	Warning lamp pops up on the center of the LCD and the buzzer sounds	<ul style="list-style-type: none"> The pop-up warning lamp moves to the original position, blinks and the buzzer stops when; - the buzzer stop switch  is pushed - the knob of the jog dial module is pushed - the lamp of the LCD is touched
	Warning lamp pops up on the center of the LCD and the buzzer sounds	<ul style="list-style-type: none"> The pop-up warning lamp moves to the original position, lights up or blinks and the buzzer stops when; - the buzzer stop switch  is pushed - the knob of the jog dial module is pushed - the lamp of the LCD is touched <p>※ Refer to page 5-78 for details.</p>
	Warning lamp pops up on the center of the LCD and the buzzer sounds	<ul style="list-style-type: none"> The pop-up warning lamp moves to the original position, lights up and the buzzer stops after 2 seconds elapses.
	Warning lamp pops up on the center of the LCD and the buzzer sounds	<ul style="list-style-type: none"> The pop-up warning lamp moves to the original position, blinks and the buzzer stops after 2 seconds elapses.
	Warning lamp pops up on the center of the LCD and the buzzer sounds	<ul style="list-style-type: none"> Cluster displays this pop-up when it has communication error with MCU. If communication with MCU become normal state, it will disappear automatically.
	Warning lamp pops up on the center of the LCD and the buzzer sounds	※ Refer to page 5-74 for details.
	Warning lamp lights up and the buzzer sounds	※ Refer to page 5-78 for details.

※ Refer to page 5-86 for the buzzer stop switch  and operator's manual page 3-67 for the jog dial module.

(1) Engine coolant temperature warning lamp







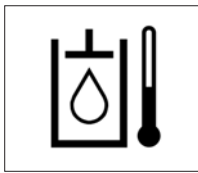

290F3CD61

- ① Engine coolant temperature warning is indicated in 2 steps.
 - 103°C over : The  lamp pops up and the buzzer sounds.
 - 107°C over : The  lamp pops up and the buzzer sounds.
- ② The pop-up ,  lamps move to the original position and blinks when the buzzer stop switch  is pushed. The buzzer will stop and ,  lamps will blink.
- ③ Check the cooling system when the lamps keep blinking.

(2) Hydraulic oil temperature warning lamp



290F3CD62

- ① Hydraulic oil temperature warning is indicated in 2 steps.
 - 100°C over : The  lamp pops up and the buzzer sounds.
 - 105°C over : The  lamp pops up and the buzzer sounds.
- ② The pop-up ,  lamps move to the original position and blinks when the buzzer stop switch  is pushed. The buzzer will stop and ,  lamps will blink.
- ③ Check the hydraulic oil level and hydraulic cooling system.

(3) Fuel level warning lamp

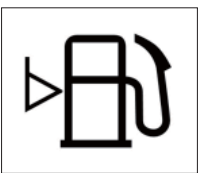

290F3CD63

- ① This warning lamp pops up and the buzzer sounds when the fuel level is below 36 ℓ (9.5 U.S. gal).
- ② Fill the fuel immediately after the lamp blinks.

(4) Emergency warning lamp



290F3CD64

- ① This warning lamp pops up and the buzzer sounds when each of the below warnings occurs.
 - Engine coolant overheating (over 107°C)
 - Hydraulic oil overheating (over 105°C)
 - MCU input voltage abnormal
 - Cluster communication data error
 - Engine ECM communication data error
- ※ The pop-up warning lamp moves to the original position and blinks when the buzzer stop switch  is pushed. The buzzer will stop.
- ② When this warning lamp blinks, machine must be checked and serviced immediately.

(5) Engine oil pressure warning lamp

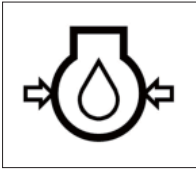

290F3CD65

- ① This warning lamp pops up and the buzzer sounds when the engine oil pressure is low.
- ② If the lamp lights up, shut OFF the engine immediately. Check oil level.

(6) Check engine warning lamp



290F3CD66

- ① This warning lamp pops up and the buzzer sounds when the communication between MCU and engine ECM is abnormal, or if the cluster received specific fault code from the engine ECM.
- ② Check the communication line between the two.
If the communication line is OK, then check the fault codes on the cluster.

(7) Battery charging warning lamp

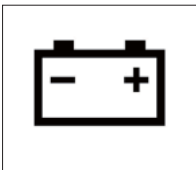

290F3CD67

- ① This warning lamp pops up and the buzzer sounds when the battery charging voltage is low.
- ② Check the battery charging circuit when this lamp blinks.

(8) Air cleaner warning lamp



290F3CD68

- ① This warning lamp pops up and the buzzer sounds when the air cleaner is clogged.
- ② Check, clean or replace filter.

(9) Overload warning lamp (opt)



290F3CD69

- ① When the machine is overloaded, the overload warning lamp pops up and the buzzer sounds when the overload switch is ON. (if equipped)
- ② Reduce the machine load.

(10) Engine stop warning lamp



290F3CD252

- ① This warning lamp pops up and the buzzer sounds after 30 minutes of run time elapses, when the DEF/AdBlue® tank has reached its minimum level. Stop engine immediately and check actual DEF/AdBlue® level.
- ② Fill the DEF/AdBlue® immediately.
※ Refer to page 5-78.
- ③ This lamp pops up and the buzzer sounds when the manual (stationary) exhaust system cleaning is not performed.
※ Refer to page 5-77.
※ Please contact your HD Hyundai Construction Equipment service center or local dealer.
※ "Engine shutdown" cluster message pops up when the exhaust gas temperature reaches above 800°C.

(11) Exhaust system cleaning warning lamp

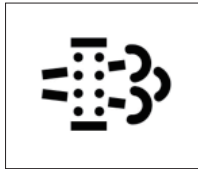

290F3CD70

- ① This warning lamp lights up or blinks when exhaust system cleaning is needed as seen in the table below.

Warning lamp				Description
Exhaust	HEST	Check engine	Stop engine	
Off	Off	Off	Off	· Normal operating mode
On (Amber)	Off	Off	Off	· Manual (stationary) exhaust system cleaning is recommended. ※ Refer to page 5-77.
On (Amber)	Off	On (Red)	Off	· Manual exhaust system cleaning must be conducted immediately. · Engine power will be reduced automatically if action is not taken. ※ Refer to page 5-77.
On (Amber)	Off	On (Red)	On (Red)	· These lamps will be ON if manual exhaust system cleaning is not conducted for a certain period of time. Stop the engine immediately. · Please contact HD Hyundai Construction Equipment service center or local dealer.
Blink (Red)	Off	Off	Off	· The exhaust system cleaning lamp will blink without HEST lamp while automatic exhaust system cleaning is being performed. · Low idle speed will increase to 1350 rpm. · The machine can be operated as normal operating mode. · Fuel consumption may slightly increase.
Blink (Red)	On (Amber)	Off	Off	· The exhaust system cleaning lamp will blink with HEST lamp while manual exhaust system cleaning is being performed. · The machine must remain stationary at low idle. ※ Refer to page 5-77.

(12) Exhaust system cleaning inhibit warning lamp

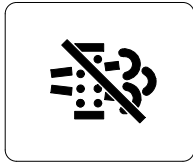

2609A3CD20

- ① This warning lamp indicates the exhaust system cleaning switch is pushed to the inhibit position, therefore automatic and manual exhaust system cleaning can not occur.
- ※ Refer to operator's manual page 3-43 for the exhaust system cleaning switch.

※ Manual exhaust system cleaning

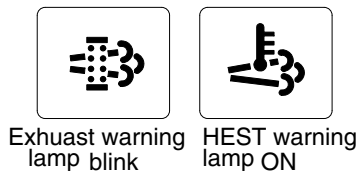
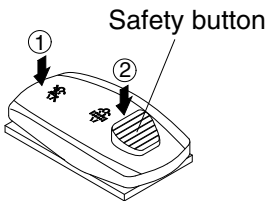

Exhaust warning lamp blink HEST warning lamp ON

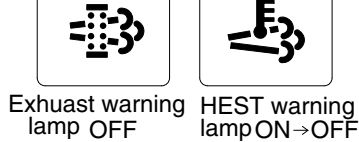

Exhaust warning lamp OFF HEST warning lamp ON → OFF

220A3CD73B

- ※ Manual exhaust system cleaning must be operated in a fireproof area.
- ※ To stop a manual exhaust system cleaning before it has completed, set to the exhaust system cleaning switch to the inhibit position or turn OFF the engine.

- ① Stop and park the machine.

- ② Pull the safety button and push the switch to position ② to initiate the manual exhaust system cleaning.

- ※ Refer to the page operator's manual 3-43 for the exhaust system cleaning switch operation.

- ※ The engine speed may increase to 1350 rpm and exhaust system cleaning begins and it will take approximately 20~30 minutes.

- ③ The exhaust system cleaning warning lamp will blink and HEST warning lamp will light up during the exhaust system cleaning operation.

- ④ The exhaust system cleaning and/or HEST warning lamp light will go off when the exhaust system cleaning is completed.

(13) HEST (High exhaust system temperature) warning lamp

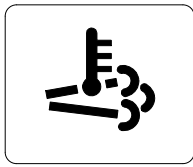

2609A3CD21

- ① This warning lamp indicates, when illuminated, that exhaust temperatures are high due to exhaust system cleaning.
- ② The lamp will also illuminate during a manual exhaust system cleaning.
- ③ When this lamp is illuminated, be sure the exhaust pipe outlet is not directed at any surface or material that can melt, burn, or explode.

▲ When this lamp is illuminated, the exhaust gas temperature could reach 800°C [1500°F], which is hot enough to ignite or melt common materials, and to burn people.

※ The lamp does not signify the need for any kind of equipment or engine service; It merely alerts the equipment operator to high exhaust temperatures. It is common for the lamp to illuminate on and off during normal equipment operation as the engine completes exhaust system cleaning cycles.

(14) DEF/AdBlue® level warning lamp



290F3CD257

- ① This warning lamp when ON or blinking, indicates that the DEF/AdBlue® level is low as per the table below.

※ It is recommended that the DEF/AdBlue® tank be filled completely full of the DEF/AdBlue® in order to correct any fault conditions.

Warning lamp				Description
Fail in SCR system	DEF/AdBlue® level	Check engine	Stop engine	
On	On	Off	Off	<ul style="list-style-type: none"> · The DEF/AdBlue® level has fallen below the initial warning level (10%).
On	On	On	Off	<ul style="list-style-type: none"> · The DEF/AdBlue® level has fallen below the initial derate level (2.5%). · The engine power will be limited automatically.
On	Blink	On	On	<ul style="list-style-type: none"> · This happens when 30 minutes has elapsed with empty conditions (0%) of the DEF/AdBlue® tank. · The engine will enter the final derate level which may include low idle lock or engine shutdown with restart limitations. · In order to remove the final derate, the DEF/AdBlue® tank must be filled to above 10% gauge reading.

(15) Water in fuel warning lamp



300A3CD24A

- ① This warning lamp lights up and the buzzer sounds when the water separator is full of water or malfunctioning.
- ※ **When this lamp lights up, stop the machine and drain water from the separator.**

(16) Seat belt reminder warning lamp



300A3CD25

- ① When operator does not fasten the operator's seat belt, the seat belt reminder warning lamp pops up and the buzzer sounds.
- ② Fasten the seat belt.

(17) Coolant level warning lamp

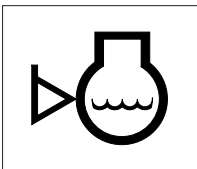

760F3CD58

- ① This warning lamp indicates lack of coolant.
- ② Check and refill coolant.

(18) Engine oil filter warning lamp

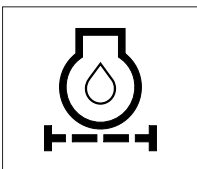

300A3CD306

- ① This warning lamp pops up and the buzzer sounds when the engine oil filter is clogged.
- ② Check, clean or replace filter.

(19) Fail in SCR system warning lamp

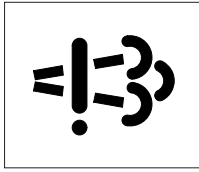

300A3CD15

- ① This warning lamp indicates there are faults related to SCR system.
 - ② The lamp lights up when each of the below warnings is happening.
 - a. Low DEF/AdBlue® level
 - b. Poor quality of DEF/AdBlue®
 - c. Tempering or malfunction in the aftertreatment system
 - ③ Once the lamp lights up, the engine will derate soon.
- ※ **Please contact your HD Hyundai Construction Equipment service center or local dealer.**

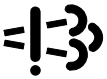
Warning lamp		Torque reduction
	Time	
On	Fault detected	-
On	After 2 h 30 min	· Torque is reduced to 75% of the highest torque.
Blink	After 3 h 45 min	· Torque is reduced to 50% of the highest torque.
Blink rapidly	After 4 hours	· Torque is reduced to 0% (low idling) of the highest torque within 2~10 min.

- ※ **If a new fault occurs within 40 hours of operation since the first fault, the warning lamp will light up. After 3 hours of operation, the warning lamp will blink rapidly and torque will be reduced to 0% (low idling) within 2~10 minutes.**
- ※ **Once the fault has been remedied and the engine control unit has received an indication that it is working, torque returns to the normal level.**

6) PILOT LAMPS

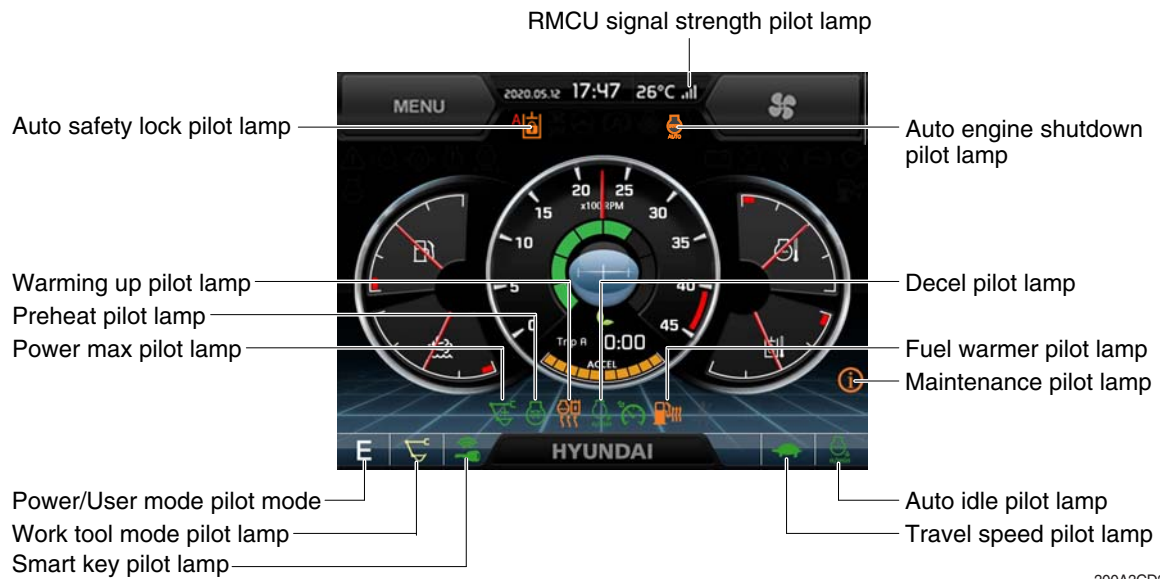

300A3CD26A

(1) Mode pilot lamps

No	Mode	Pilot lamp	Selected mode
1	Power mode		Heavy duty power work mode
			Standard power mode
			Economy power mode
2	User mode		User preferable power mode
3	Work tool mode		General operation - IPC speed mode
			General operation - IPC balance mode
			General operation - IPC efficiency mode
			Breaker operation mode
			Crusher operation mode
			Lifting mode
4	Travel mode		Low speed traveling
			High speed traveling
5	Auto idle mode		Auto idle

(2) Power max pilot lamp



300A3CD32

- ① The lamp will be ON when pushing power max switch on the LH RCV lever.
 - ② The power max function operates for a max period of 8 seconds.
- ※ Refer to the operator's manual page 3-45 for power max function.

(3) Preheat pilot lamp

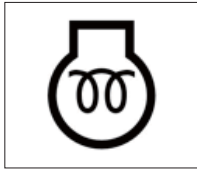

290F3CD79

- ① Turning the start key switch to the ON position starts preheating in cold weather.
- ② Start the engine after this lamp goes OFF.

(4) Warming up pilot lamp

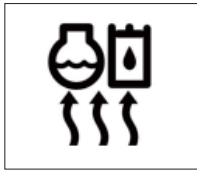

290F3CD80

- ① This lamp lights up when the coolant temperature is below 30°C (86°F).
- ② The automatic warming up is cancelled when the engine coolant temperature is above 30°C (86°F), or when 10 minutes have passed since starting the engine.

(5) Decel pilot lamp



300A3CD33

- ① Operating one touch decel switch on the RCV lever makes the lamp light up.
- ② Also, the lamp will light up and engine speed will be reduced automatically to save fuel when all levers and pedals are in the neutral position, and the auto idle function is selected.
- ③ If it follows the case below, decel goes off in the idle state.
 - Auto idle button off
 - Working/Travel
 - One touch decel button off
 - Safety knob unlock

※ Refer to the operator's manual page 3-45.

(6) Fuel warmer pilot lamp

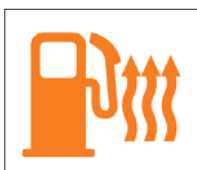

300A3CD34

- ① This lamp lights up when the coolant temperature is below 10°C (50°F) or the hydraulic oil temperature is 20°C (68°F).
- ② The automatic fuel warming is cancelled when the engine coolant temperature is above 60°C (140°F), and the hydraulic oil temperature is above 45°C (113°F) since the start switch was ON position.

(7) Maintenance pilot lamp



300A3CD35

- ① This lamp lights up when consumable parts are in need of replacement. It means that the change or replacement interval of parts is 30 hours from the required change interval.
- ② Check the message in maintenance information of main menu. Also, this lamp lights up for 3 minutes when the start switch is switched to the ON position.

※ Refer to page 5-96.

(8) RMCU signal strength pilot lamp (mobile only)



220A3CD200

① This lamp indicates RMCU signal strength as below.

- : Searching
- : Bad
- : Normal
- : Good
- : Excellent

(9) Smart key pilot lamp (opt)



300A3CD36A

① This lamp lights up when the engine is started by the start button.

② This lamp is red when the authentication fails, it will be green when authentication is successful.

※ Refer to the page 5-97.

(10) Auto safety lock pilot lamp



300A3CD37A

① Auto safety lock system prevents unintended operation of the machine in order to improve safety.

② Engine will only start if safety knob is locked.

③ If operator unlocks safety knob when RCV lever is pressed, machine is not controlled by RCV lever.

⚠ If operator unlocks safety knob while any control/function is being operated, the machine will move violently. This could cause serious injury, death or damage to property.

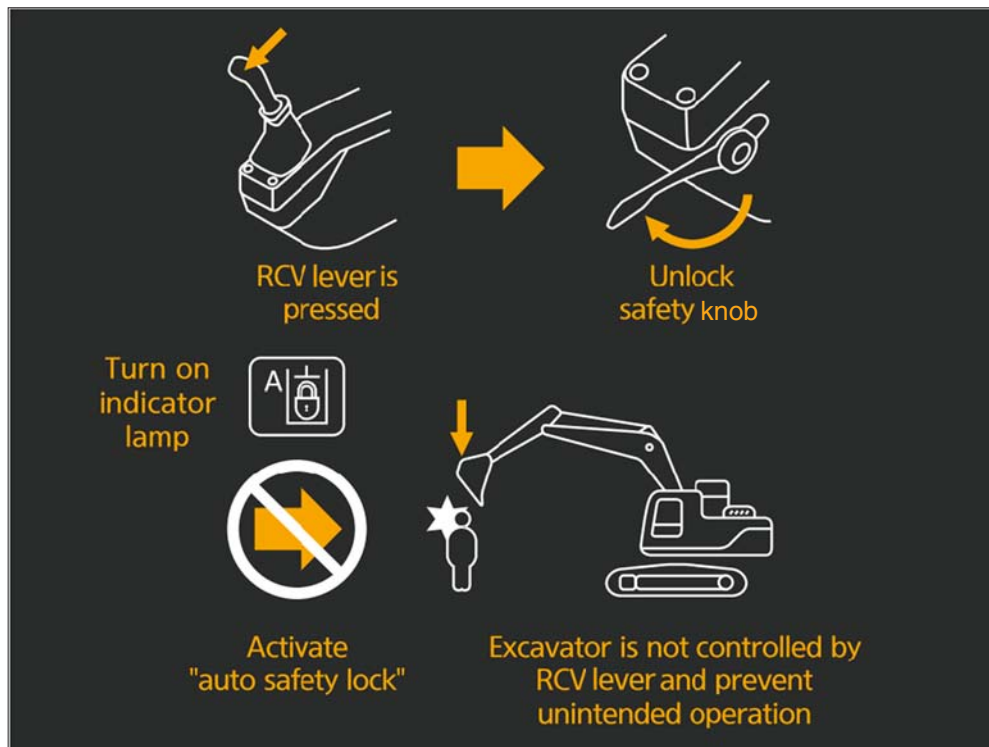

300A3CD38A

(11) Auto engine shutdown pilot lamp



220A3CD202A

① This lamp lights up when the auto engine shutdown is activated.

※ Refer to page 5-92.

7) SWITCHES



300A3CD39A

※ When some of the switches are selected, the pilot lamps are displayed on the LCD. Refer to page 5-81 for details.

(1) Power mode switch

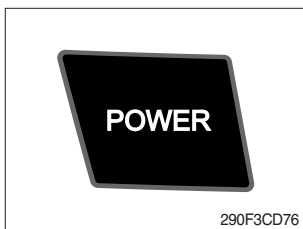

- This switch is to select the machine power mode and when pressed, the power mode pilot lamp will be displayed on the section of the monitor.
 - P : Heavy duty power work.
 - S : Standard power work.
 - E : Economy power work.
- The pilot lamp changes E → S → P → E in this order.

(2) Work mode switch

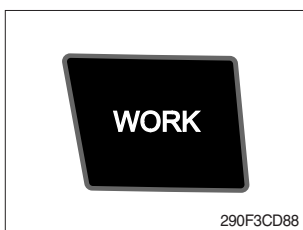

- This switch is to select the machine work mode, which shifts from general operation mode to optional attachment operation mode or lifting mode.
 - : General operation mode
 - : Breaker operation mode (if equipped)
 - : Crusher operation mode (if equipped)
 - : Lifting mode
 - Not installed : Breaker or crusher is not installed and lifting mode is not activated.

※ Refer to the operator's manual page 2-7 for details.

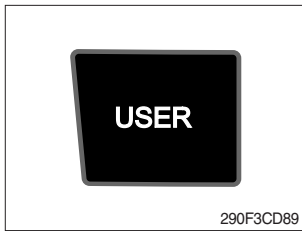

(3) User mode switch



- ① This switch is used to select the user mode.
- ② Refer to page 5-90 for another set of the user mode.

(4) Travel speed switch



- ① This switch is used to select the travel speed alternatively.
 -  : Low speed
 -  : High speed

※ Do not change the setting of the travel speed switch while machine is moving. Machine stability may be adversely affected.

▲ Serious injury or death can result from sudden changes in machine stability.

(5) Auto idle/ buzzer stop switch



- ① This switch is used to activate or cancel the auto idle function.
 - Pilot lamp ON : Auto idle function is activated.
 - Pilot lamp OFF : Auto idle function is cancelled.
- ② The buzzer sounds when the machine has a problem. In this case, push this switch and buzzer stops, but the warning lamp blinks until the problem is cleared.

(6) Escape/Camera switch

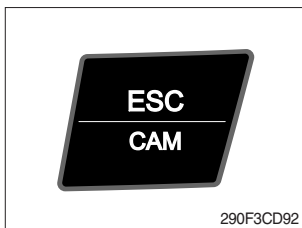

- ① This switch is used to return to the previous menu or parent menu.
- ② In the operation screen, pushing this switch will display the view of the camera on the machine (if equipped). Please refer to page 5-103 for the camera.
- ③ If the camera is not installed, this switch is used only ESC function.

(7) Work light switch

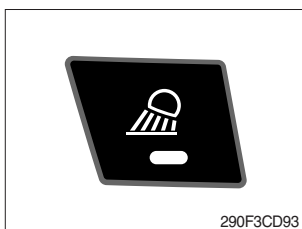

- ① This switch is used to operate the work light.
- ② The pilot lamp lights up when this switch is pressed.

(8) Head light switch



- ① This switch is used to operate the head light.
- ② The pilot lamp lights up when this switch is pressed.

(9) Intermittent wiper switch



- ① When this switch is pressed, wipers operate intermittently.
- ② The pilot lamp lights up when this switch is pressed.

(10) Wiper switch



- ① This switch is used to operate the wiper.
- ② Note that the wiper will self-park when switched off.
- ③ The pilot lamp lights up when this switch is pressed.
- △ **If the wiper does not operate with the switch in ON position, turn the switch OFF immediately. Check the cause. If the switch remains ON, motor failure can result.**

(11) Washer switch



- ① Washer fluid is sprayed and the wiper is operated only when this switch is pressed.
- ② The pilot lamp lights up when this switch is pressed.

(12) Cab light switch

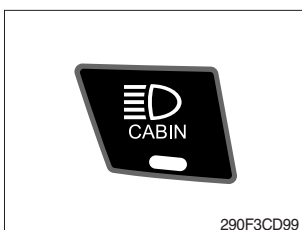

- ① This switch turns on the cab light.
- ② The pilot lamp lights up when this switch is pressed.

(13) Beacon switch (opt)

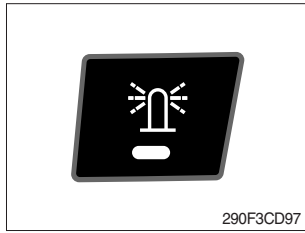

- ① This switch activates the rotary light on the cab.
- ② The pilot lamp lights up when this switch is pressed.

(14) Overload switch (opt)

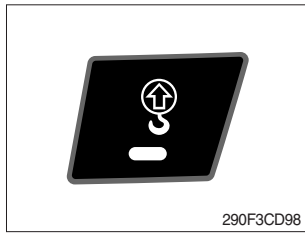

- ① When this switch is activated, buzzer makes sound and overload warning lamp lights up in the event that the machine is or becomes in an overloaded situation.
- ② When the switch is inactivated, buzzer stops and warning lamp goes off.

⚠ Overloading the machine could impact the machines stability which could result in tipover hazard. A tipover hazard could result in serious injury or death. Always activate the overload warning device before you handle or lift objects.

(15) Travel alarm switch

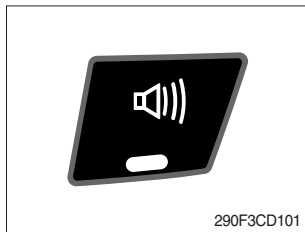

- ① This switch is to activate travel alarm function surrounding when the machine travels.
 - ON : The travel alarm function is activated.
 - OFF : The travel alarm function is not activated.

(16) Air conditioner quick touch switch

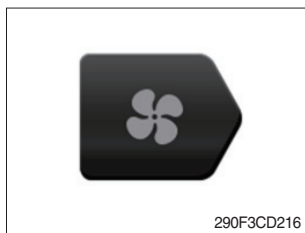

- ① This switch used to select air conditioner control mode.
※ Refer to page 5-105.

(17) Main menu quick touch switch



- ① This switch is to activate the main menu in the cluster.
※ Refer to page 5-89.

8) MAIN MENU

※ You can select or set the menu by the jog dial module or touch screen.

On the operation screen, tap MENU to access the main menu screen.

On the sub menu screen, you can tap the menu bar to access functions or applications.





· Operation screen



300A3CD40A

※ Please refer to the jog dial module, operator's manual page 3-67 for selection and change of menu and input value.

(1) Structure

No	Main menu	Sub menu	Description
1	 Mode 290F3CD103	Work mode U mode power Boom/Arm speed Auto power boost IPC mode Auto engine shutdown Initial mode Emergency mode	Breaker, Crusher, Lifting Mode, Not installed User mode only Boom speed, Arm speed Enable, Disable Speed mode, Balance mode, Efficiency mode One time, Always, Disable Key on initial mode / initial work mode, Accel initial mode / step Switch function
2	 Monitoring 290F3CD104	Active fault Logged fault Delete logged fault Monitoring	MCU, Engine ECM, FATC, AAVM (option) MCU, Engine ECM, FATC, AAVM (option) All logged fault delete, Initialization canceled Machine information, Switch status, Output status
3	 Management 290F3CD105	Fuel rate information Maintenance information Machine security Machine information Contact Service menu Clinometer Update	General record, Hourly, Daily, Mode record Replacement, Change interval oils and filters ESL mode setting, Password change Model, MCU, Monitor, jog dial module, switch controller, RMCU, Relay drive unit, FATC, AAVM (option) A/S phone number, A/S phone number change Power shift, Operating hour, Breaker mode pump acting, EPPR current level, Overload pressure Clinometer setting Cluster, ETC device
4	 Display 290F3CD106	Display item Clock Brightness Unit setup Language selection	Engine speed, Tripmeter A, Tripmeter B, Tripmeter C Clock Manual, Auto Temperature, Pressure, Flow, Distance, Date format Korean, English, ETC
5	 Utilities 290F3CD107	Tripmeter Camera	3 kinds (A, B, C) Camera setting, Auto mode (travel)

(2) Mode setup

① Work mode

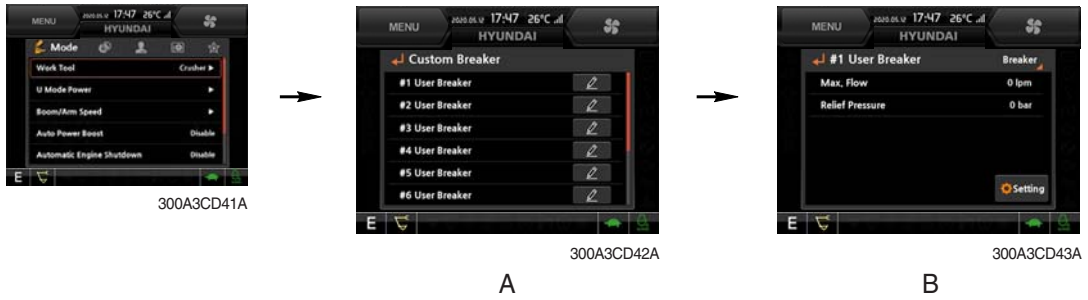

- Select installed optional attachment
 - A : It can set the user's attachment.
It is available in setting #1~#10.
 - B : Max flow - Set the maximum flow for the attachment.
Relief pressure - Set the relief pressure.

② U mode power

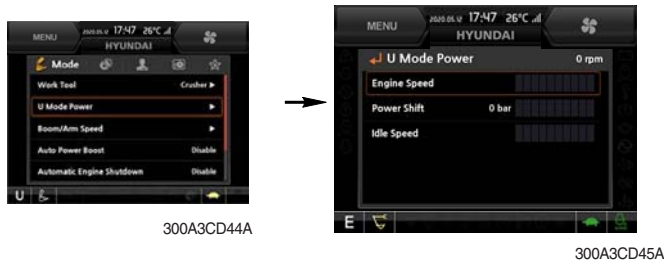

Step (■)	Engine speed (rpm)	Idle speed (rpm)	Power shift (bar)
1	1300	750	0
2	1400	800	3
3	1500	850	6
4	1600	900	9
5	1700	950	12
6	1800	1000	16
7	1850	1050	20
8	1900	1100	26
9	1950	1150	32
10	2000	1200 (auto decel)	38

- Engine high idle rpm, auto idle rpm and pump torque (power shift) can be modulated and memorized separately in U-mode.
- U-mode can be activated by user mode switch.

※ One touch decel : 1100 rpm

※ Low idle speed

- Safety knob release : 1100 rpm

- Safety knob lock : 1100 rpm

③ Boom/Arm speed



- **Boom speed**
 - Boom priority function can be activated or cancelled
Enable - Boom up speed is automatically adjusted as working conditions by the MCU.
Disable - Normal operation
- **Arm speed**
 - Arm regeneration function can be activated or cancelled.
Enable - Arm in speed is up.
Disable - Normal operation.

④ Auto power boost



- The power boost function can be activated or cancelled.
 Enable - The digging power is automatically increased as working conditions by the MCU.
 It is operated max 8 seconds, then goes off for a period of 1 second and then activates again for 8 seconds and continues this cycle.
 Disable - Not operated.

⑤ IPC mode



- The IPC mode can be selected by this menu.
 - Speed mode
 - Balance mode (default)
 - Efficiency mode
- ※ Please update the cluster programs if this mode is not displayed in the mode setup menu. Refer to the page 3-32.

⑥ Automatic engine shutdown



300A3CD58A



300A3CD59A



300A3CD60A

- The automatic engine shutdown function can be set by this menu.
 - One time
 - Always
 - Disable
 - Wait time setting : Max 40 minutes, min 2 minutes

⑦ Initial mode



300A3CD61A



300A3CD62B

- **Key on initial mode**
 - Selected the power mode is activated when the engine is started.
- **Key on initial work mode**
 - Not installed
 - Last setting
 - Work mode
- **Accel initial mode**
 - Last setting value
 - User setting value
- **Accel initial step**
 - 0~9 step

⑧ Emergency mode



300A3CD63A



300A3CD64A

- This mode can be used when the switches are abnormal on the cluster.
- The cluster switches can be selected by touching each icon.

(3) Monitoring

① Active fault



- The active faults of the MCU, ECM, FATC, AAVM (option) can be checked by this menu.

② Logged fault

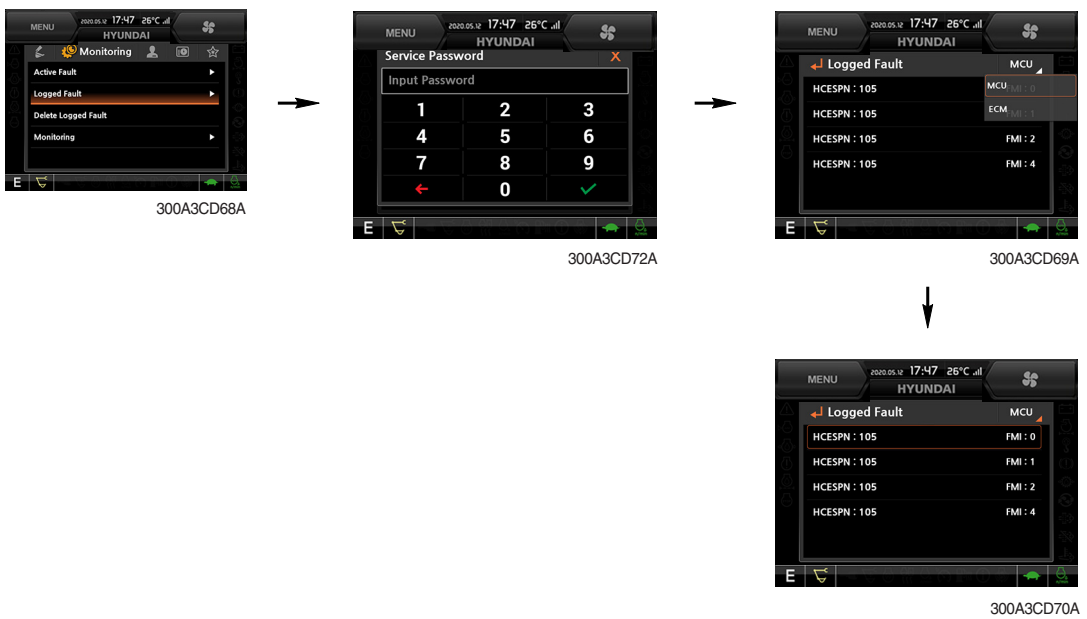

- The logged faults of the MCU, ECM, FATC, AAVM (option) can be checked by this menu.

③ Delete logged fault



- The logged faults of the MCU, ECM, FATC, AAVM (option) can be deleted by this menu.

④ Monitoring

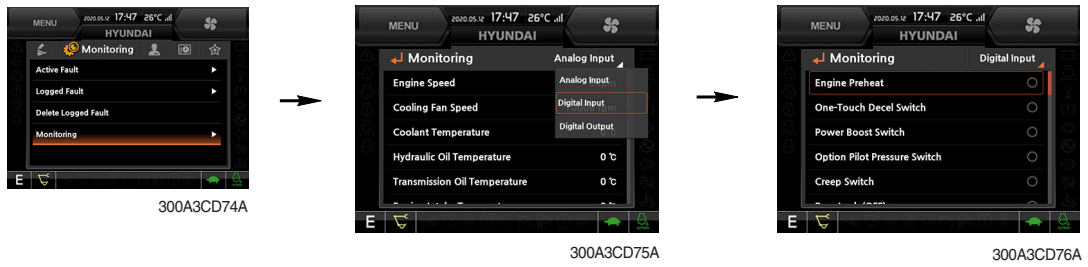

- The machine status such as the engine rpm, oil temperature, voltage and pressure etc. can be checked by this menu (Analog input).
- The switch status or output status can be confirmed by this menu (Digital input & Digital output).
- The activated switch or output pilot lamps ● will light up.

(4) Management

① ECO report

This reports the machine's inefficient operation status in order to improve operator's improper working habit.

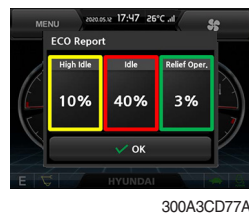

High idle



Idle



- Shows a breakdown of high idle, idle and relief operation when monitor is on.
- Gives a daily usage breakdown record for a 7 day period and an overall accumulated record from the first operation.

Relief operation



② Fuel rate information



A



B



C



D



· General record (A)

- Average fuel rate (left) (from "Reset" to now)
Fuel consumption divided by engine run time (service meter time).
- A days fuel used (right)
Fuel consumption from 24:00 (or "Reset" time) to now (MCU real time).

· Hourly record (B)

- Hourly fuel rates for past 12 hours (service meter time).
- No record during key-off time.
- One step shift to the right for every one hour.
- Automatic deletion of data from 12 hours and earlier.
- "Reset" deletes all hourly records.

· Daily record (C)

- Daily fuel consumption for past seven days (MCU real time).
- No record during key-off time.
- One step shift to the right at 24:00 for every day.
- Automatically deletes data from 7 days and earlier.
- All daily records deletion by "Reset".

· Mode record (D)

- Average fuel rate for each power mode/accl dial (at least 7) from "Reset" till present.
- No record during idle.
- All records can be deleted by "Reset".

③ Maintenance information



300A3CD87A



300A3CD88A



300A3CD89A

- Alarm lamp (●) is ON when oil or filter needs to be changed or replaced.
- Replacement : The elapsed time will be reset to zero (0).
- Change interval : The change intervals can be changed in hour increments of 50.
- ※ Refer to section, Maintenance chart for further information of maintenance interval.

④ Machine security



300A3CD90A



300A3CD91A

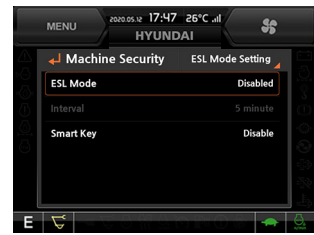

300A3CD92A

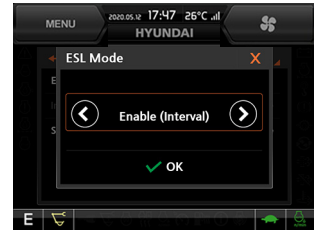

300A3CD93A



300A3CD94A

· ESL mode setting

- ESL : Engine Starting Limit
- ESL mode is designed to be a theft deterrent or will prevent the unauthorized operation of the machine.
- When you Enable the ESL mode, the password will be required when the starting switch is turned to the on position.

- Machine security

Disable : ESL function is disabled and password is not required to start engine.

Enable (always) : The password is required whenever the operator starts engine.

- **Interval** : The password is required when the operator starts engine first. But the operator can restart the engine within the interval time without inputting the password. The interval time can be set to a maximum 4 hours.

※ Default password : 00000 + ✓

※ Password length : (5~10 digits) + ✓

- Smart key (option) : Refer to next page.

· Password change

- The password is 5~10 digits.



300A3CD95A



300A3CD96A



300A3CD91A

Enter the current password



300A3CD98A

Enter the new password again



300A3CD99A

Enter the new password

※ Before first use, please set user password and owner password in advance for machine security.

- Smart key



- Smart key is registered when equipped with optional smart key. If smart key is not inside of the cabin, authentication process fails and the password is needed.
- Tag management menu is activated when the Smart key menu is Enabled.
You can register and delete the tags.

- Tag management

- When registering a tag : Only the tag you want to register must be in the cabin.
- When deleting a tag : All registered tags are deleted.

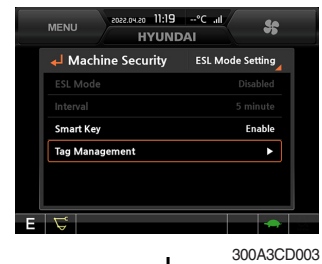
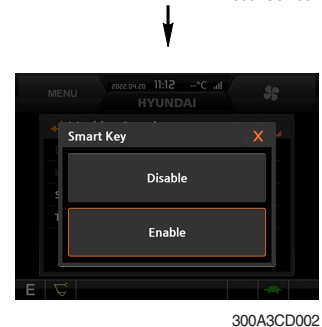

Deleting ←

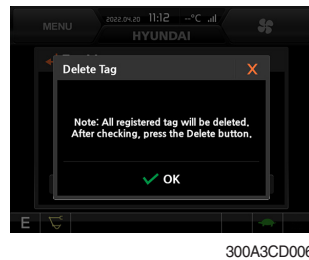

Registering ↓

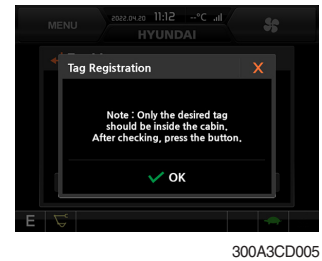

⑤ Machine Information

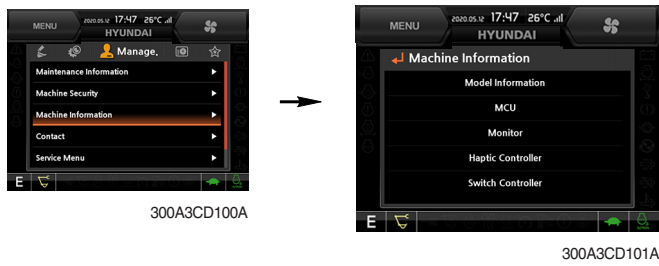

- This can confirm the identification of the model information (ECU), MCU, monitor, jog dial module, switch controller, RMCU, relay driver unit, FATC, AAVM (opt).

⑥ Contact (A/S phone number)



Enter the new A/S phone number

⑦ Service menu

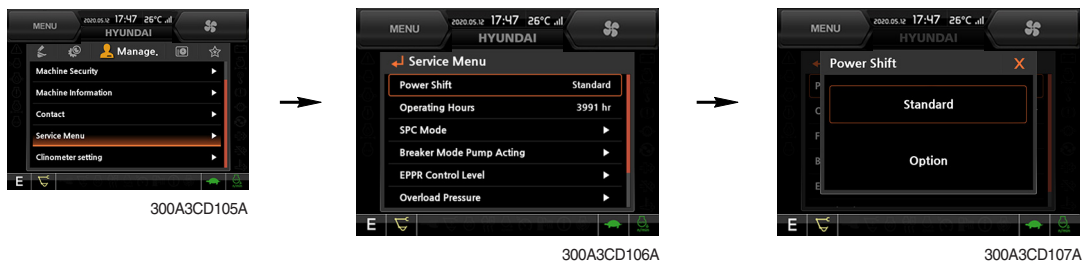

※ This menu can be used only HCE service man and can not be accessible by the owner and the operator.

- Power shift (standard/option) : Power shift pressure can be set by option menu.
- Operating hours : Operating hours since the machine line out can be checked by this menu.
- Breaker mode pump acting (1 pump/2 pump)
- EPPR current level (attach flow EPPR 1 & 2, boom priority EPPR, attach relief pressure EPPR 1 & 2)
- Overload pressure : 100 ~ 350 bar

⑧ Clinometer

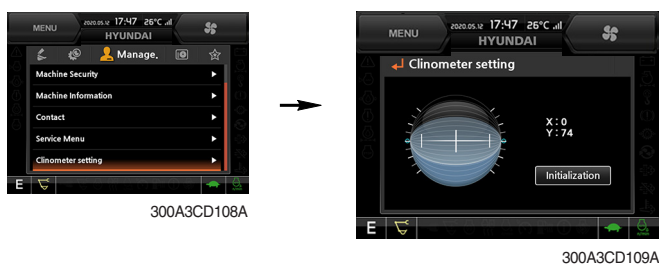

- When the machine is on the flatland, if you touch "initialization" on cluster, the values of X, Y will reset to "0".
- You can confirm tilt of machine in cluster's operating screen.

⑨ Update (cluster & ETC devices)

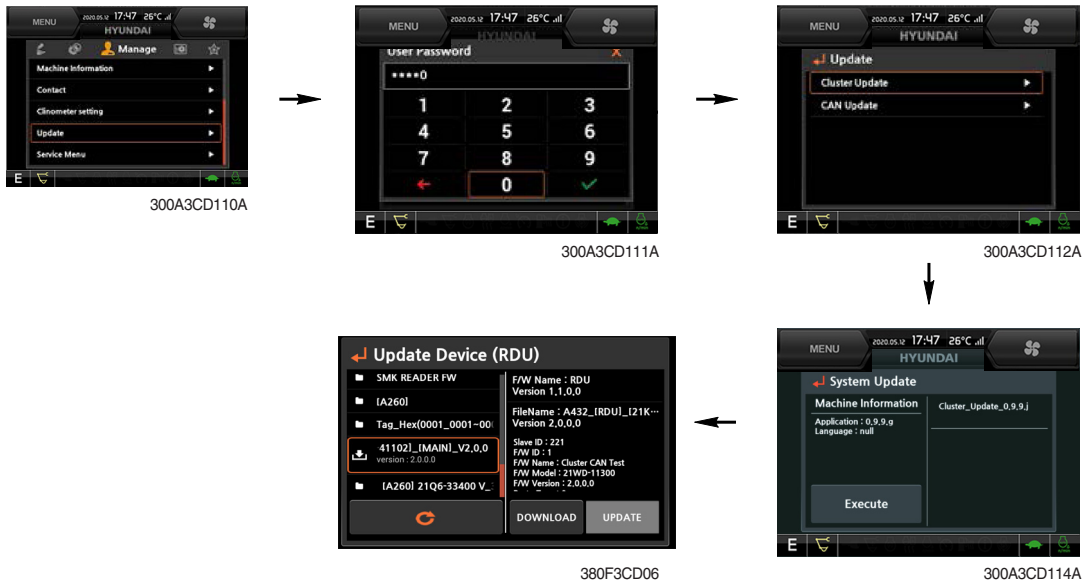

- ETC devices and cluster can be updated through CAN 2 network.
- Insert USB memory stick which includes program files, start download.

⑩ OME (owner menu editing)

The owner of machine can restrict operator access to set functions.

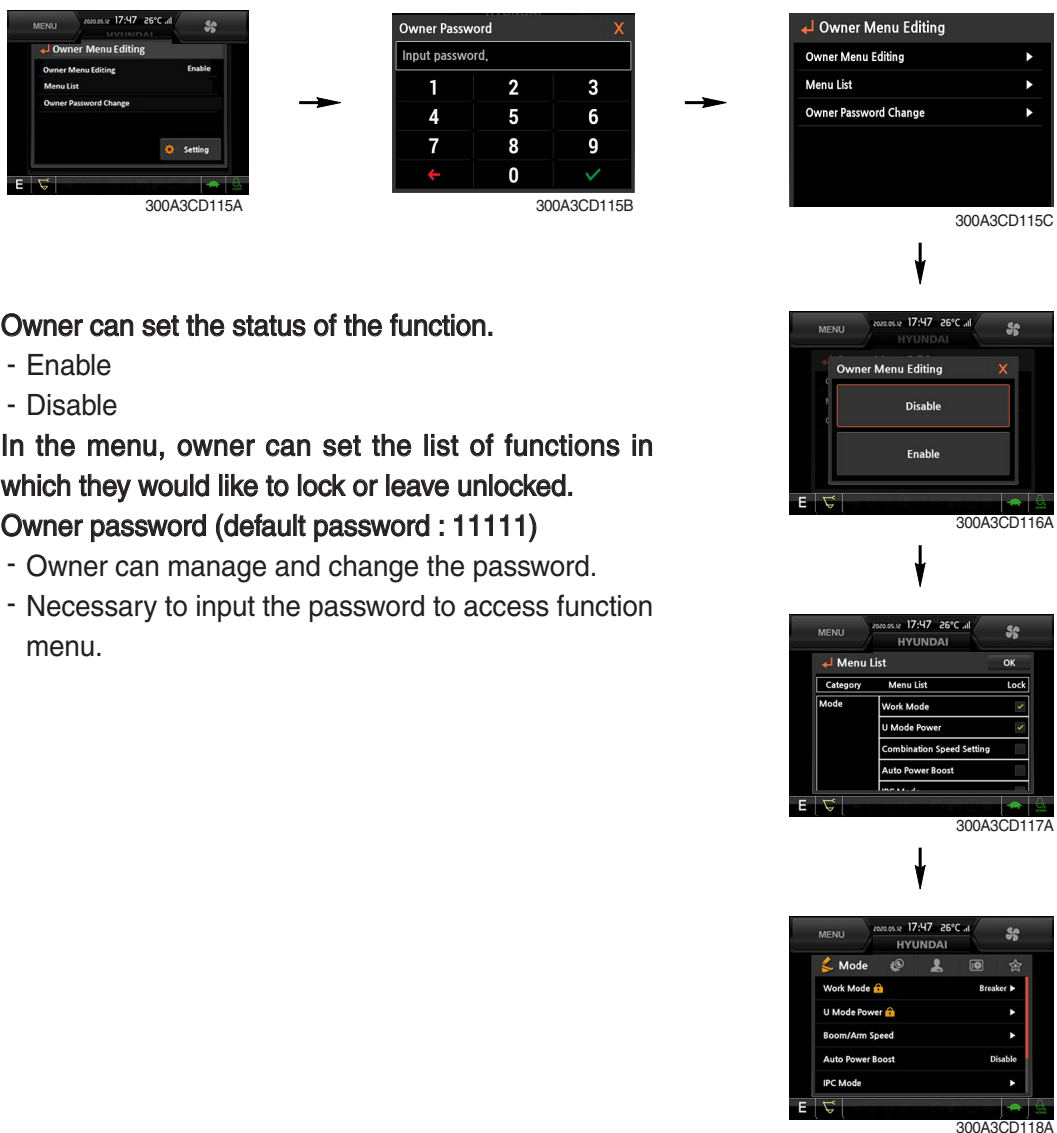

- **Owner can set the status of the function.**
 - Enable
 - Disable
- **In the menu, owner can set the list of functions in which they would like to lock or leave unlocked.**
- **Owner password (default password : 1111)**
 - Owner can manage and change the password.
 - Necessary to input the password to access function menu.

(5) Display

① Display item



300A3CD119A



300A3CD120A



300A3CD121A

- The center display type of the LCD can be selected by this menu.
- The engine speed or the tripmeter menu (A,B,C) is displayed on the center display.

② Clock



300A3CD122A



300A3CD123A

- The first row of boxes indicate Year/Month/Day.
- The second row shows the current time. (0:00~23:59)

③ Brightness



- If "Auto" is chosen, brightness for day and night can be set accordingly. Also by using the bar in lower side, users can define which an operation interval belongs to day and night. (in bar figure, white area represents night time while orange shows day time)

④ Unit

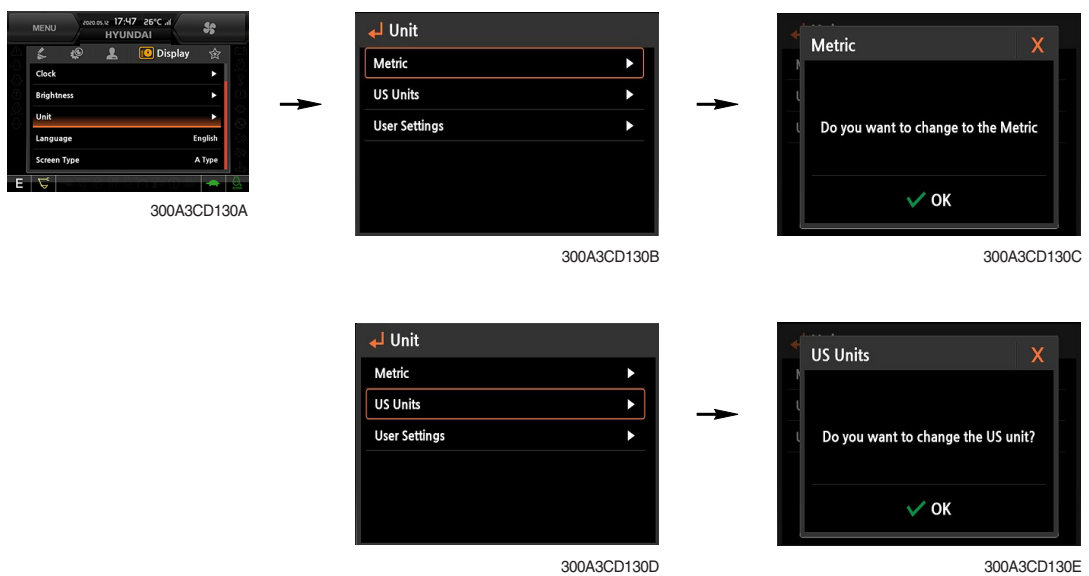

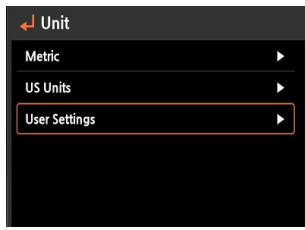

300A3CD130F

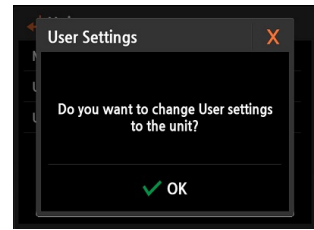

300A3CD130G



300A3CD131A

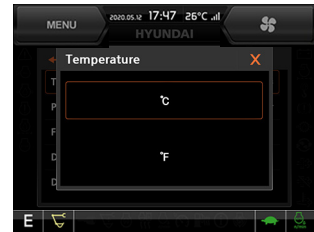

300A3CD132A

- Temperature : °C ↔ °F
- Pressure : bar ↔ MPa ↔ kgf/cm²
- Volume : l ↔ gal
- Flow : lpm ↔ gpm
- Distance : km ↔ mile
- Date format : yy/mm/dd ↔ mm/dd/yy ↔ dd-mm-yy

⑤ Language



300A3CD133A



300A3CD134A

- User can select preferable language and all displays are changed to the selected language.

(6) Utilities

① Tripmeter

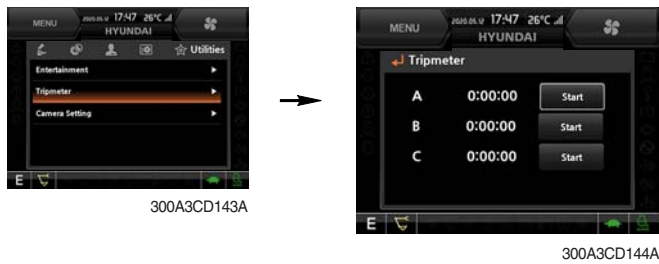

- A maximum of 3 types of tripmeters can be used at the same time.
- Each tripmeter can be turned on by choosing "Start". It can be turned off by choosing "Stop".
- If the tripmeter icon is activated in the operation screen, it can be controlled directly in this screen.

② Camera setting

- If the rear camera is not installed on the machine, set disable.
- If the rear camera is installed on the machine, set enable.



- Auto Mode (Travel) : Enable
The cluster will automatically show camera view while machine is traveling.
- In the operation screen, rear camera screen shows up when ESC/CAM switch is pushed.

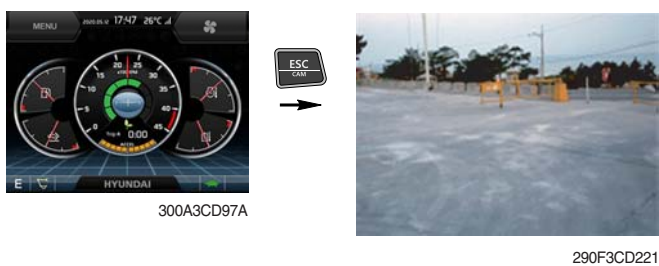

③ **AAVM** (Advanced Around View Monitoring, option)

- The AAVM switches of the cluster consist of ESC/CAM and AUTO IDLE/Buzzer stop.



300A3CD149A

- **Escape switch**

- Activates AAVM mode from the beginning if AAVM is installed.
- While in the AAVM mode, select the ESC switch to return to the home screen.



300A3CD97A

Home screen

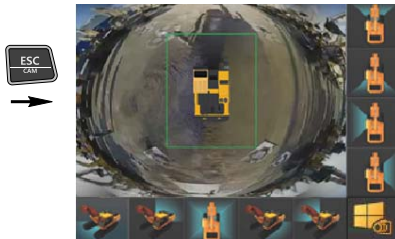

AAVM mode

235SA3CD222A

- **Buzzer stop switch**

- AAVM mode detects surrounding pedestrians or objects and the warning buzzer sounds.
- User can turn OFF the warning sound by pressing the buzzer stop switch.



220A3CD246

- When a worker/pedestrian reaches the green line, which is an external danger area equipped on the cluster, warning buzzer sounds and it displays a green rectangular box recognizing the worker/pedestrian. Stop work immediately. Stop the buzzer by pressing the buzzer stop switch. Then resume work after you confirm that the area is safe and clear of workers/objects.



220A3CD247

- When a worker/pedestrian reaches the red line, which is an internal danger area equipped on the cluster, warning buzzer sounds and it displays a red rectangular box recognizing the worker/pedestrian. Stop work immediately. Stop the buzzer by pressing the buzzer stop switch. Then resume work after you confirm that the area is safe and clear of workers/objects.

▲ Failure to comply may result in serious injury or death.

※ In AAVM mode, a touch screen of the LCD is available only. The multimodal dial of the jog dial module is not available.

9) AIR CONDITIONER AND HEATER

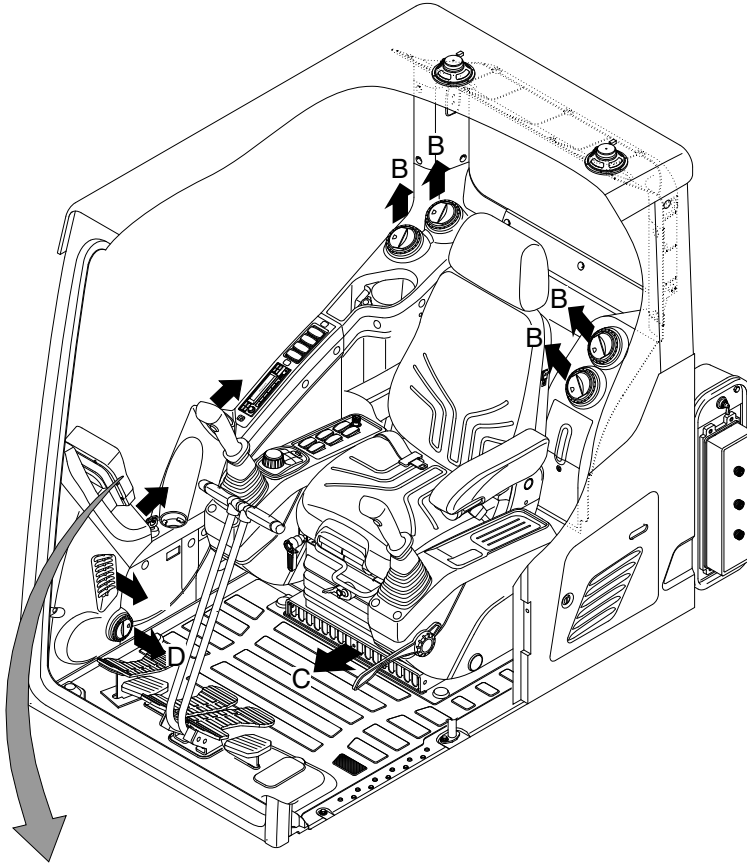

Full auto air conditioner and heater system automatically keeps the optimum condition in accordance with operator's temperature configuration sensing ambient and cabin inside temperature.

· Location of air flow ducts



Cluster LCD



Cluster :  or
Jog dial module : 

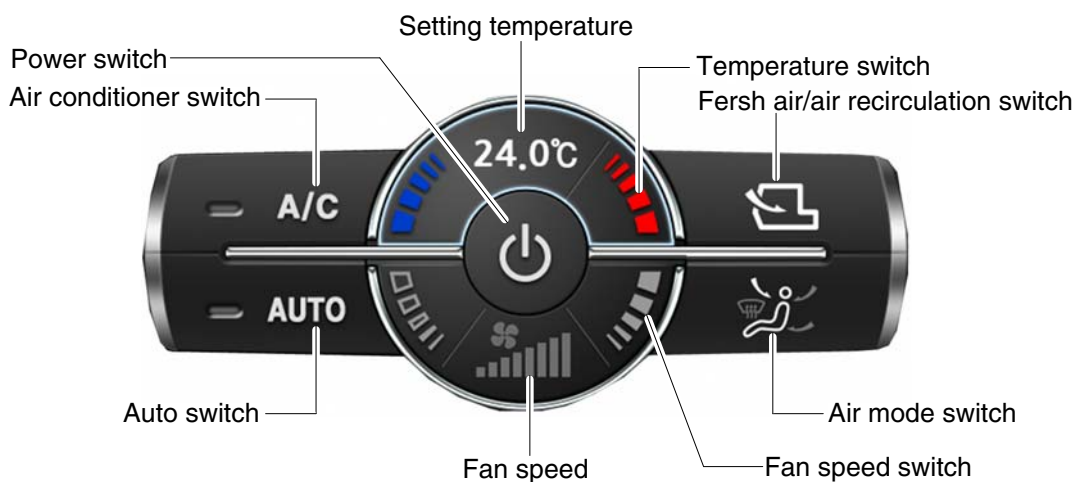

※ Jog dial module : Refer to page operator's manual 3-67.

160A3CD21

(1) Power switch



- ① This switch turns the system ON and OFF.
Just before powering OFF, set values are stored.
- ② Default setting values

Function	Air conditioner	In/outlet	LCD	Temperature	Mode
Value	OFF	Inlet	OFF	Previous sw OFF	Previous sw OFF

(2) Air conditioner switch



- ① This switch turns the compressor ON/OFF.
- ※ **Air conditioner operates to remove vapor and drains water through a drain hose. Water can be sprayed into the cab in case that the drain cock at the ending point of drain hose has a problem.**
In this case, exchange the drain cock.

(3) Auto switch



- ① Auto air conditioner and heater system automatically keeps the optimum condition in accordance with operator's temperature configuration sensing ambient and cabin inside temperature.

(4) Setting temperature



- ① Displays the temperature setting.

(5) Temperature switch

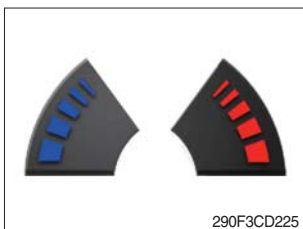

- ① Setting temperature indication
· Lo (17°C), 17.5~31.5°C, Hi (32°C)
- ② Max cool and max warm beeps 5 times.
- ③ The max cool or the max warm position operates per the following table.

Temperature	Compressor	Fan speed	In/outlet	Mode
Max cool	ON	Hi (8 step)	Recirculation	Face
Max warm	OFF	Hi (7 step)	Fresh	Def/Foot

- ④ Temperature unit can be changed between celsius (°C) and fahrenheit (°F)
 - a. Default status (°C)
 - b. The temperature unit can be changed (°C ↔ °F) by pressing temperature switches (Up/Down) simultaneously for more than 5 seconds.

(6) Fan speed switch

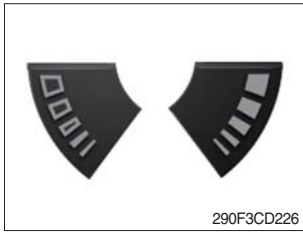

- ① Fan speed is controlled automatically by set temperature.
- ② This switch controls fan speed manually.
 - There are 8 up/down steps to control fan speed.
 - The maximum step or the minimum step beeps 5 times.

(7) Fan speed

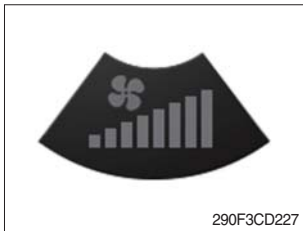

- ① Steps 1 through 8 to display the amount of air being circulated.

(8) Fresh air/air recirculation switch



- ① It is possible to change the air-inlet method.
 - a. **Fresh air** (☞)
 - Inhaling air from the outside.
 - b. **Air recirculation** (☞)
 - It recycles the heated or cooled air to increase the energy efficiency.
- ※ **Change air occasionally when using recirculation for a long periods of time.**
- ※ **Check condition of an outer filter and an inner filter periodically to maintain good efficiency of the system.**

(9) Air mode switch



- ① Operating this switch, it beeps and displays symbol of each mode in the following order. (Face → Face/Rear → Face/Rear/Foot → Foot → Def/Foot)

Mode switch	Face	Face/Rear	Face/Rear/Foot	Foot	Def/Foot
Outlet	A	●	●	●	
	B		●	●	
	C			●	●
	D				●

- ② When operating defroster, FRESH AIR/AIR RECIRCULATION switch turns to FRESH AIR mode and air conditioner switch turns ON.

(10) Self Diagnosis Function

- ① Diagnostic methods : Diagnostic information window, select
- ② Diagnostic indication (Displays fault)

Fault code	Description	Fail safe function
F01	Ambient temperature sensor open	20°C alternate value control
F02	Ambient temperature sensor short	
F03	Cab inside temperature sensor open	25°C alternate value control
F04	Cab inside temperature sensor short	
F05	Evaporate temperature sensor open	0°C alternate value control
F06	Evaporate temperature sensor short	
F07	Null	-
F08	Null	-
F09	Mode 1 actuator open/short	The alternate value is face
F10	Mode 1 actuator drive circuit malfunction	If not, the alternate value is Def/Foot
F11	Intake actuator open/short	The alternate value is air recirculation
F12	Intake actuator drive circuit malfunction	The alternate fresh air
F13	Temperature actuator open/short	If opening amount is 0 %, the alternate value is 0 %
F14	Temperature actuator drive circuit malfunction	If not, the alternate value is 100 %
F15	Null	-
F16	Null	-

GROUP 16 FUEL WARMER SYSTEM

1. SPECIFICATION

- 1) Operating voltage : 24 ± 4 V
- 2) Power : 350 ± 50 W
- 3) Current : 15 A

2. OPERATION

- 1) The current of fuel warmer system is automatically controlled without thermostat according to fuel temperature.
 - 2) At the first state, the 15 A current flows to the fuel warmer and engine may be started in 1~2 minutes.
 - 3) If the fuel starts to flow, ceramic-disk in the fuel warmer heater senses the fuel temperature to reduce the current as low as 1.5 A.
- So, fuel is protected from overheating by this mechanism.

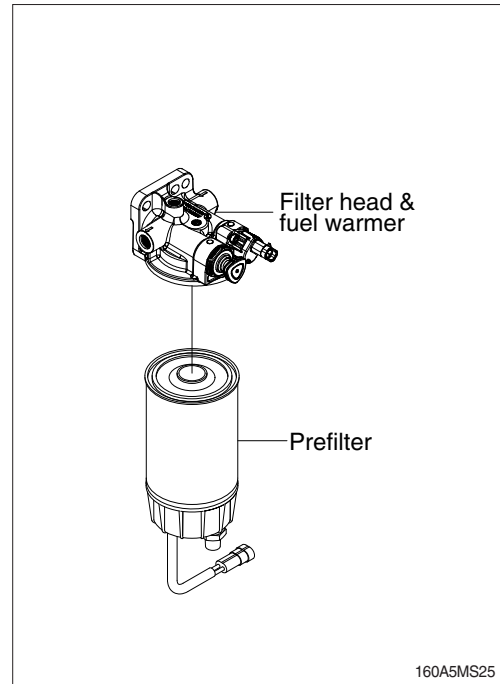

3. ELECTRIC CIRCUIT

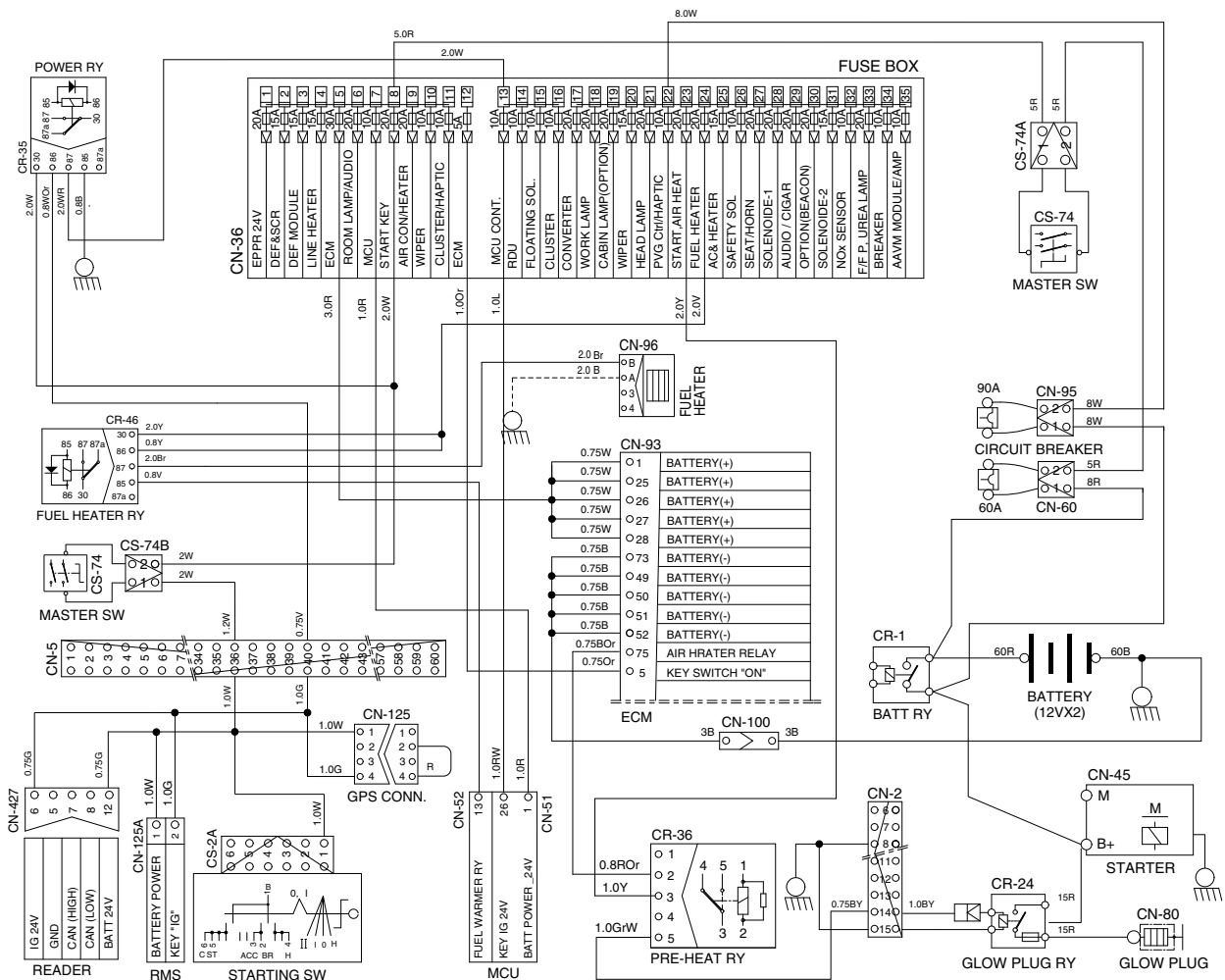

140A5MS26

GROUP 17 1 or 2-WAY OPTIONAL PIPING PRESSURE REMOVAL SYSTEM

■ Machine serial no. : #0326~

1. OUTLINE

This system can be removed the residual pressure of the optional attachment hydraulic piping when the quick coupler is operated by the switch of the RCV lever and then the oil quick function of the optional attachment is performed.

※ Oil quick function

In a convention work, the optional attachments such as breaker or grab are installed on the machine and needed to connect hydraulic piping additionally.

But currently, the hydraulic piping connection is not needed by the work man. The attachment is installed on the machine and the hydraulic pipings are connected by a coupler that is built in the quick coupler automatically and the attachment can be ready to operate immediately. This is called the oil quick function.

2. OPERATING PRINCIPLE

This is operated by controlling the setting pressure of the electric type relief valve when you operate the quick coupler with the switch of the RCV lever.

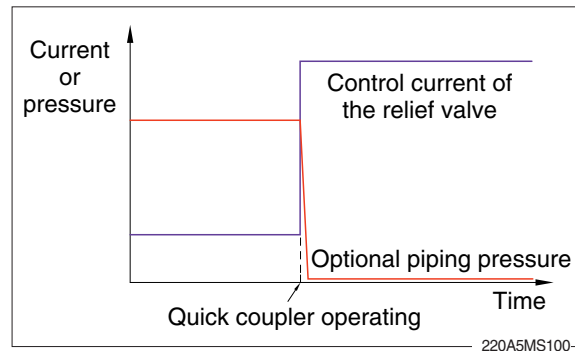

3. SETTING METHOD

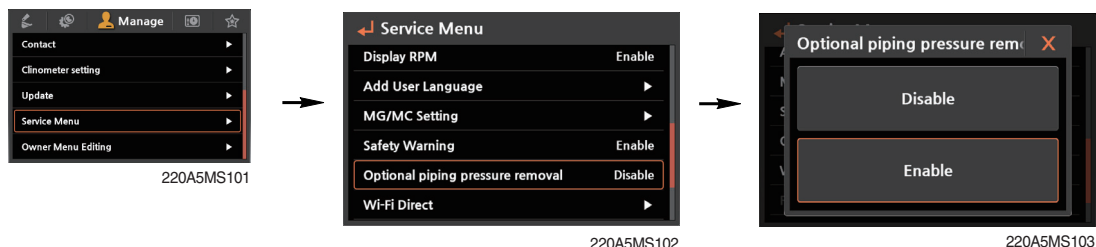

- 1) Optional piping pressure removal is set to Disable in the factory.
- 2) Optional piping pressure removal is set to Enable then the oil quick function is operated. Also, the caution letter is display on the lower side of the cluster.
- 3) The setting condition is saved even if shut the engine off.

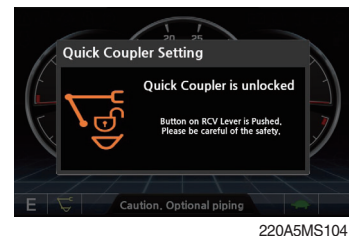

4. CAUTION

- 1) When the oil quick function is used, the hydraulic drift and etc can be occurred as the modified equipment specification.
- 2) The status of the cluster must be changed by a manager that is well-acquainted with the function and the operator must be well-informed of the oil quick function and safety work.