

SECTION 5 MECHATRONICS SYSTEM

| | |
|---|-------|
| Group 1 Outline | 5-1 |
| Group 2 Mode Selection System | 5-3 |
| Group 3 Automatic Deceleration System | 5-6 |
| Group 4 Power Boost System | 5-7 |
| Group 5 Travel Speed Control System | 5-8 |
| Group 6 Automatic Warming Up System | 5-9 |
| Group 7 Engine Overheat Prevention System | 5-10 |
| Group 8 Variable Power Control System | 5-11 |
| Group 9 Attachment Flow Control System | 5-12 |
| Group 10 Intelligent Power Control System | 5-13 |
| Group 11 Anti-Restart System | 5-15 |
| Group 12 Self-Diagnostic System | 5-16 |
| Group 13 Engine Control System | 5-62 |
| Group 14 EPPR Valve | 5-63 |
| Group 15 Monitoring System | 5-68 |
| Group 16 Fuel Warmer System | 5-105 |
| Group 17 1 or 2-Way Optional Piping Pressure Removal System | 5-106 |

GROUP 1 OUTLINE

The ADVANCED CAPO (Computer Aided Power Optimization) system controls engine and pump mutual power at an optimum and less fuel consuming state for the selected work by mode selection, auto-deceleration, power boost function, etc. It monitors machine conditions, for instance, engine speed, coolant temperature, hydraulic oil temperature, and hydraulic oil pressure, etc. It consists of two MCU, a cluster, an ECM, EPPR valves, and other components. The MCU and the cluster protect themselves from over-current and high voltage input, and diagnose malfunctions caused by short or open circuit in electric system, and display error codes on the cluster.

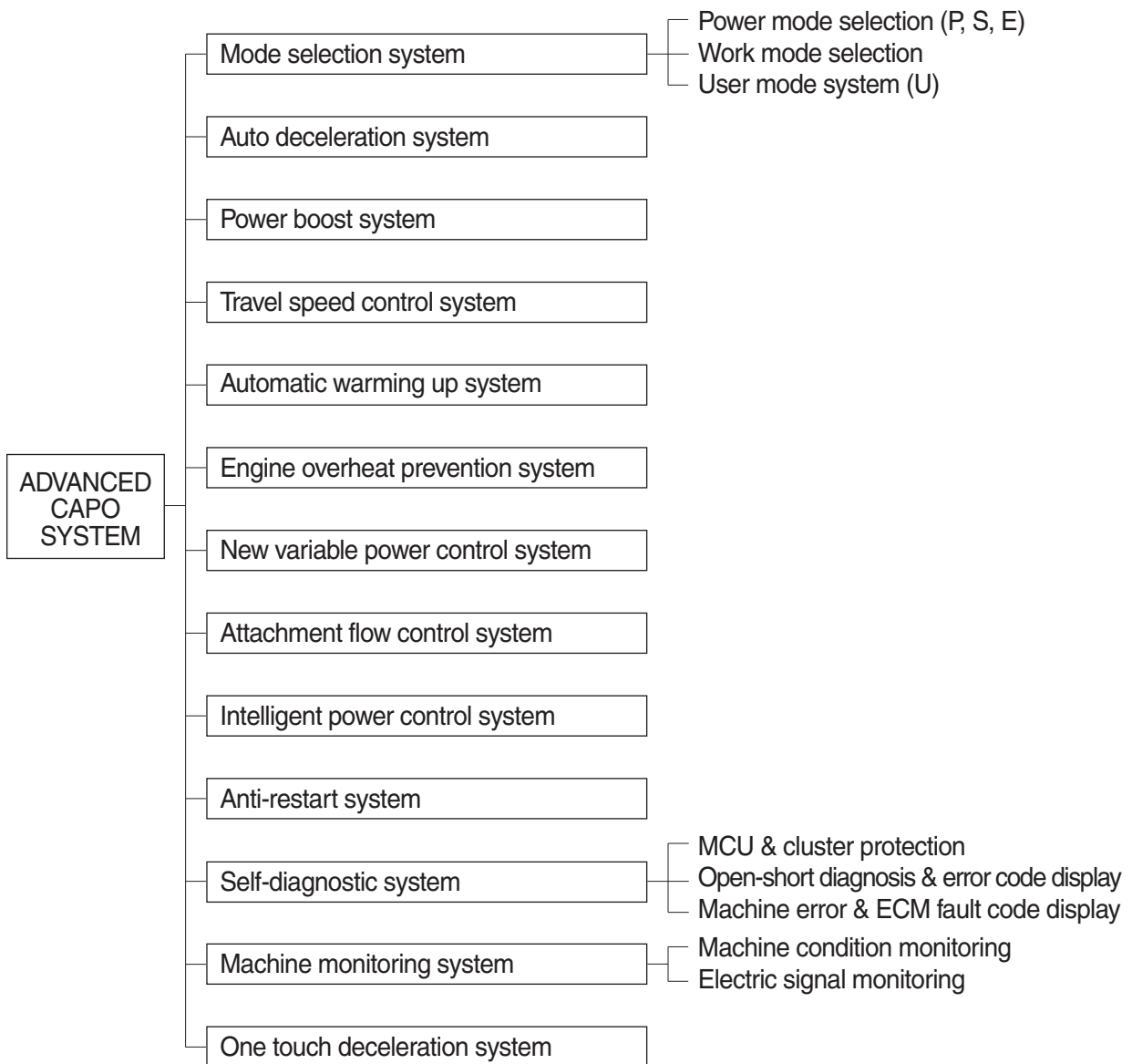

SYSTEM DIAGRAM

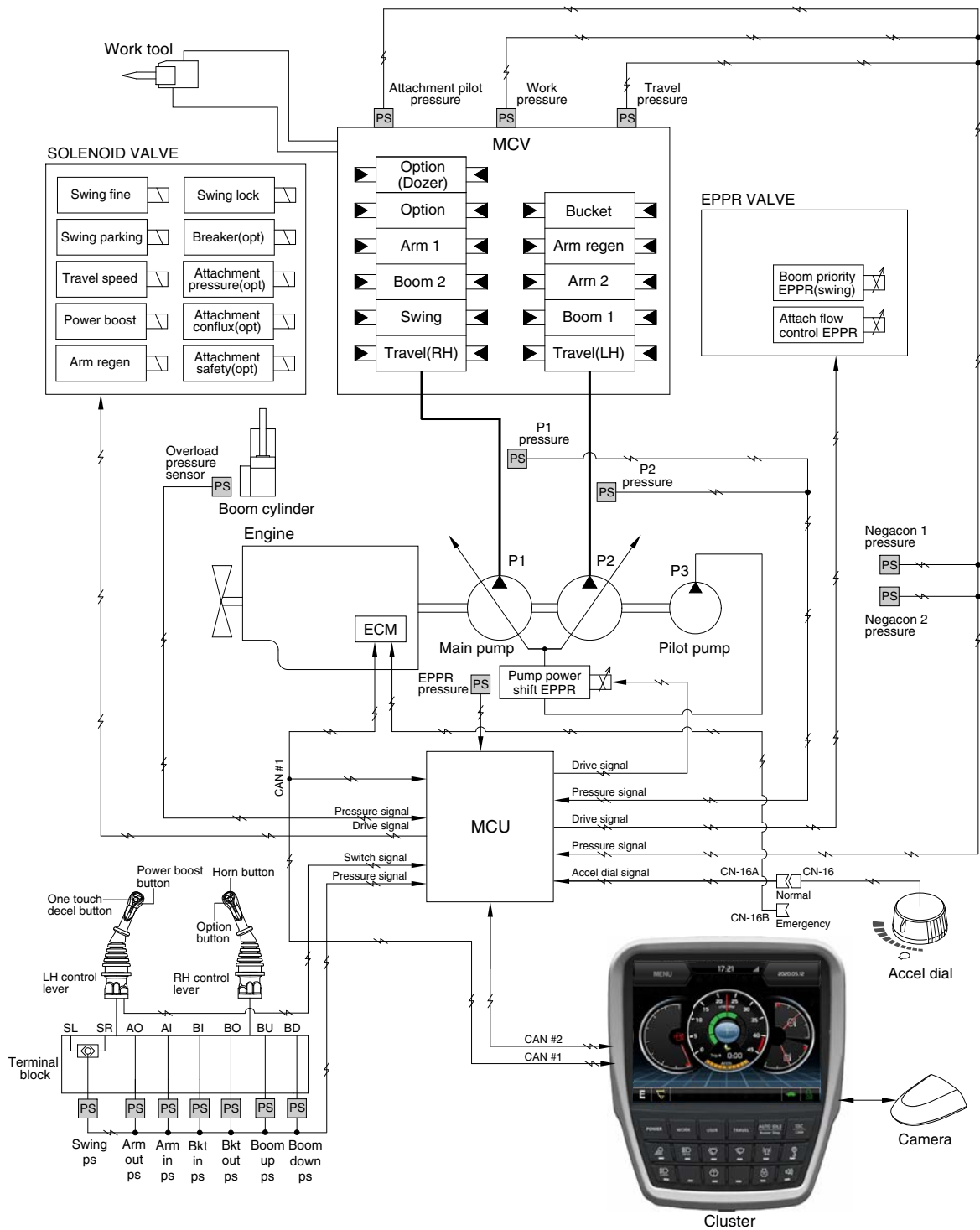

130A5MS01

GROUP 2 MODE SELECTION SYSTEM

1. POWER MODE SELECTION SYSTEM

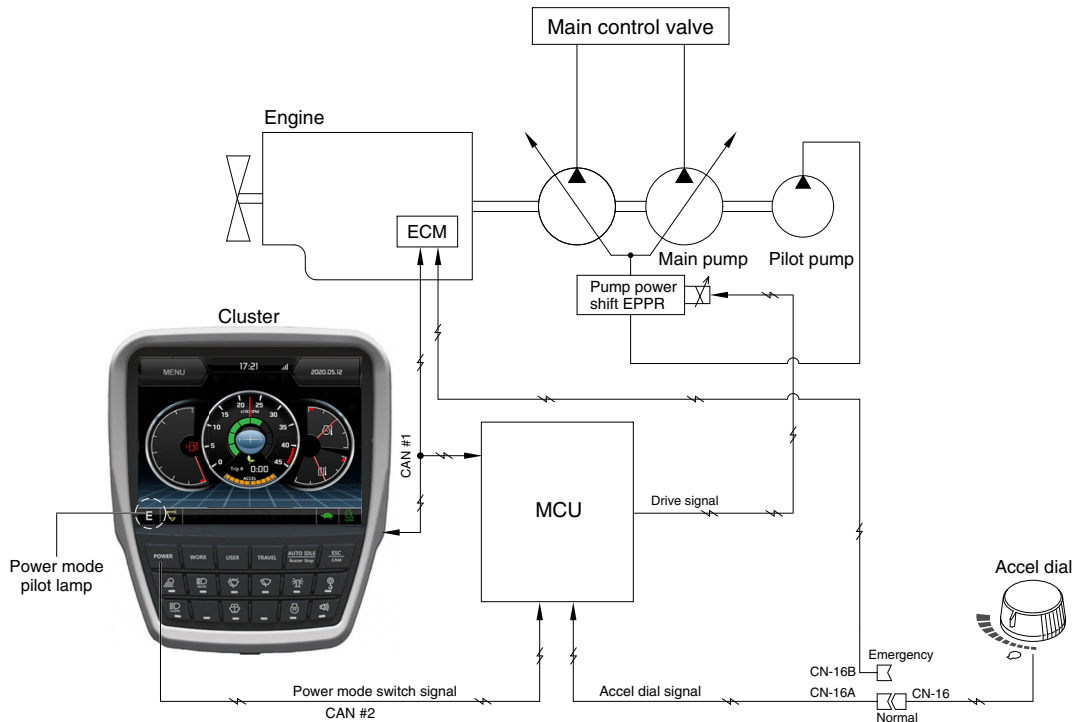

130A5MS02

Mode selection system (micro computer based electro-hydraulic pump and engine mutual control system) optimizes the engine and pump performance.

The combination of 3 power modes (P, S, E) and accel dial position (10 set) makes it possible to use the engine and pump power more effectively corresponding to the work conditions from a heavy and great power requesting work to a light and precise work.

| Power mode | Application | Engine rpm | | | | Pump EPPR (kgf/cm ²) | | | |
|-----------------|---------------------------|------------|------|-----------|------|----------------------------------|------|---------|------|
| | | Standard | | Option | | Standard | | Option | |
| | | No load | Load | No load | Load | No load | Load | No load | Load |
| P | Heavy duty power | 1850 | 1950 | 1950 | 1950 | 10 | 3 | 8 | 3 |
| S | Standard power | 1750 | 1850 | 1850 | 1850 | 12 | 5 | 9 | 4 |
| E | Economy operation | 1650 | 1750 | 1750 | 1750 | 12 | 5 | 10 | 5 |
| Auto decel | Engine deceleration | 1200 ± 50 | - | 1200 ± 50 | - | 38 | 38 | 38 | 38 |
| One touch decel | Engine quick deceleration | 1100 ± 50 | - | 1100 ± 50 | - | 38 | 38 | 38 | 38 |
| Key start | Key switch start position | 1000 ± 50 | - | 1000 ± 50 | - | 38 | 38 | 38 | 38 |

- ※ Power shift (Standard/Option) can be changed by "Service menu" in "Management" on the cluster.
- ※ In work modes, engine speed stays at 1000 rpm if the safety lever is at "LOCK" position. (Low idle goes to 1100 rpm if "UNLOCK")
- ※ Auto decel, one touch decel and low idle speed may increase to 1400 rpm while automatic exhaust system cleaning is being performed.

2. WORK MODE SELECTION SYSTEM

Work mode consists of the general operation (bucket) and the optional attachment (breaker, crusher).

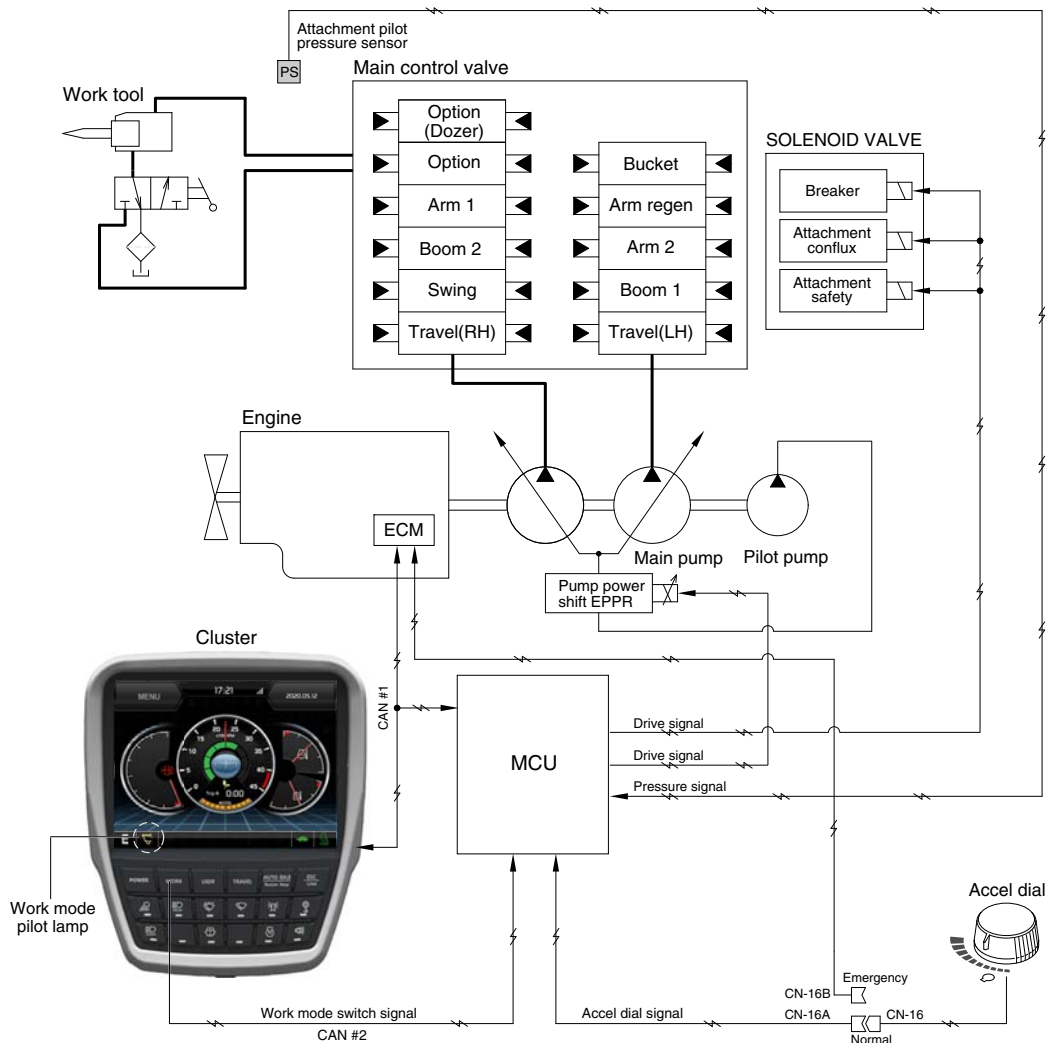

130A5MS03

1) GENERAL WORK MODE (bucket)

This mode is used to general digging work.

2) ATT WORK MODE (breaker, crusher)

It controls the pump flow and system pressure according to the operation of breaker or crusher.

| Description | General mode | Work tool | |
|------------------------------|--------------|------------|------------|
| | Bucket | Breaker | Crusher |
| Attachment safety solenoid | OFF | - | ON |
| Attachment conflux solenoid | OFF | ON/OFF | ON/OFF |
| Attachment flow EPPR current | 100 mA | 100~700 mA | 100~700 mA |
| Breaker solenoid* | OFF | ON | - |

★ When breaker operating button is pushed.

3. USER MODE SELECTION SYSTEM

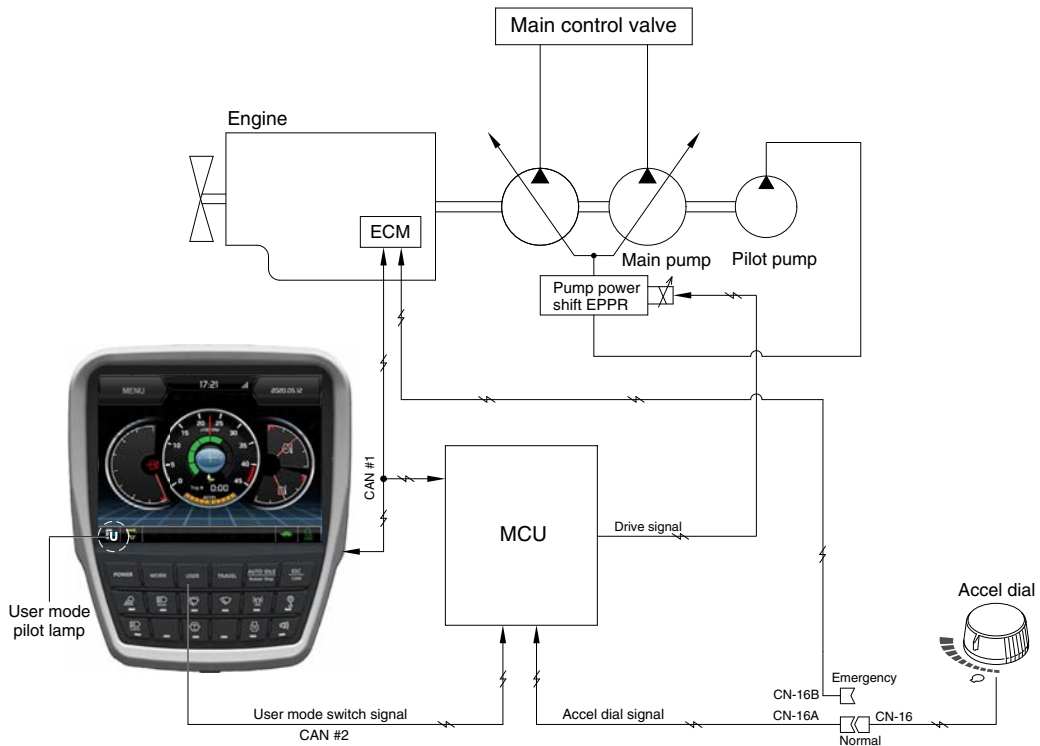

130A5MS04

1) Engine speed, idle speed and pump power shift pressure can be adjusted and memorized in the U-mode.

2) LCD segment vs parameter setting

| Step () | Engine speed (rpm) | Idle speed (rpm) | Power shift pressure (bar) |
|-------------|-----------------------|---------------------|-------------------------------|
| 1 | 1300 | 750 | 0 |
| 2 | 1400 | 800 | 3 |
| 3 | 1500 | 850 | 6 |
| 4 | 1600 | 900 | 9 |
| 5 | 1700 | 950 | 12 |
| 6 | 1800 | 1000 | 16 |
| 7 | 1850 | 1050 | 20 |
| 8 | 1900 | 1100 | 26 |
| 9 | 1950 | 1150 | 32 |
| 10 | 2000 | 1200 (auto decel) | 38 |

※ Refer to the page 5-86.

GROUP 3 AUTOMATIC DECELERATION SYSTEM

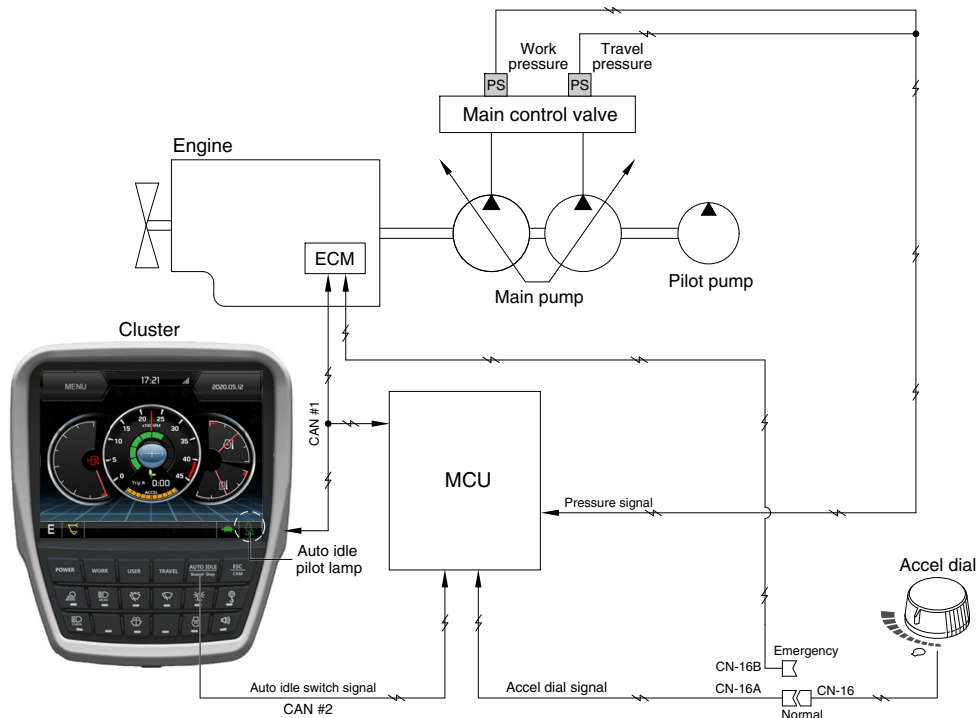

130A5MS05

1. WHEN AUTO IDLE PILOT LAMP ON

When all of the work equipment control levers including swing and travel levers are at neutral for 4 seconds, MCU sends throttle command to ECM to reduce the engine speed to 1200 rpm. If the control levers are at neutral for 1 minute, MCU reduces the engine speed to 1100 rpm. As the result of reducing the engine speed, fuel consumption and noise are effectively cut down during non-operation of the control levers.

When the auto idle pilot lamp is turned off by pressing the switch or any control lever is operated, the reduced engine speed rises up to the speed before deceleration in a second.

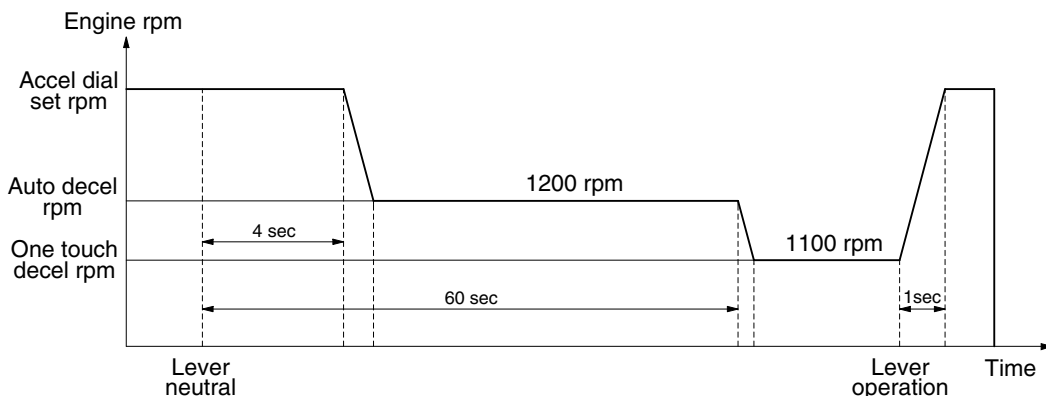

130A5MS20A

2. WHEN AUTO IDLE PILOT LAMP OFF

The engine speed can be set as desired using the accel dial, and even if the control levers are neutral, the engine speed is not reduced.

※ Auto idle function can be activated when accel dial position is over 4.

GROUP 4 POWER BOOST SYSTEM

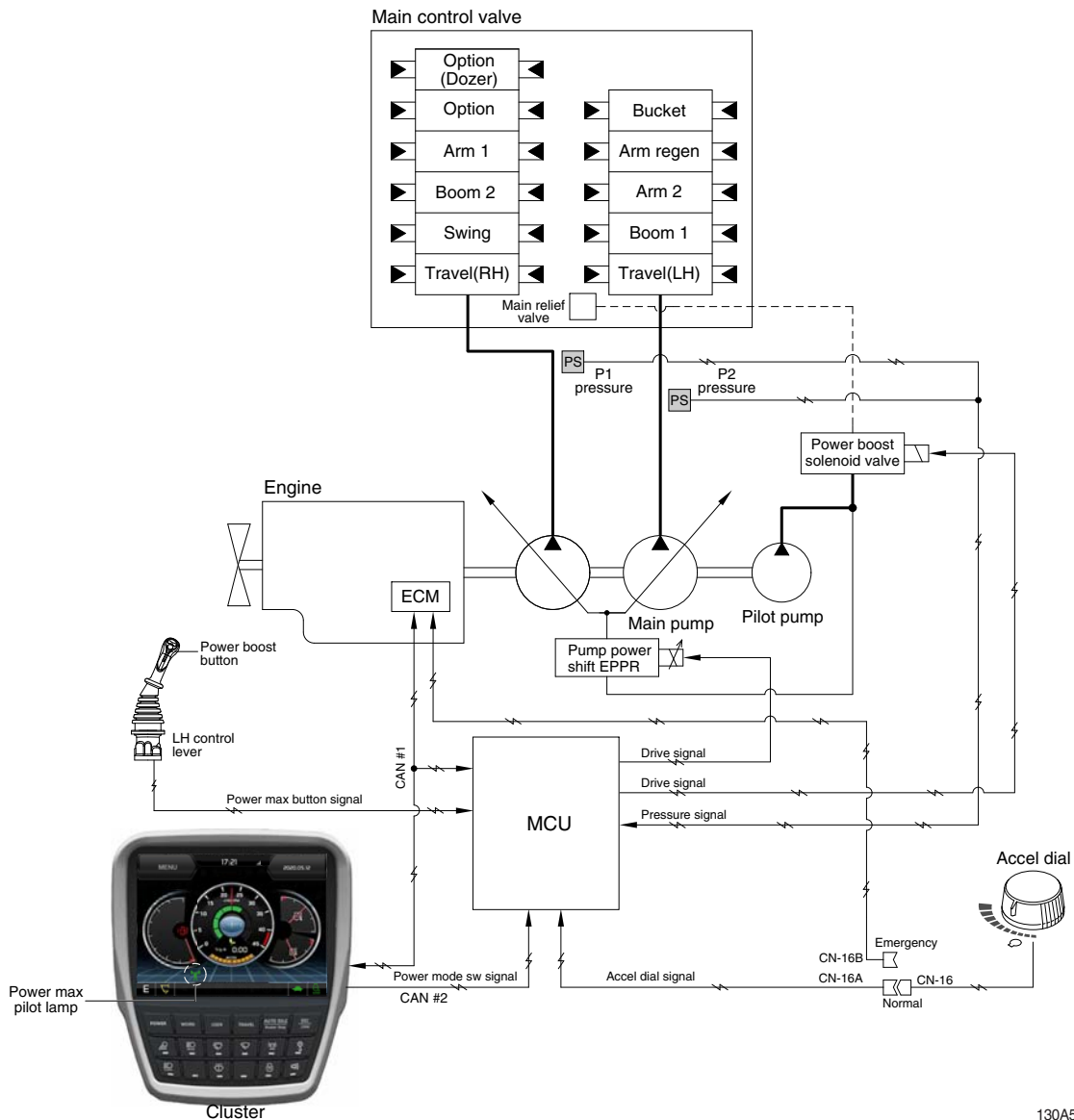

130A5MS06

- When the power boost switch on the left control lever is pushed ON, the power mode is set P mode and maximum digging power is increased by 10 %.
- When the power boost function is activated, the power boost solenoid valve pilot pressure raises the set pressure of the main relief valve to increase the digging power.

| Description | Condition | Function |
|-------------|--|--|
| Activated | Power boost switch : ON Accel dial : over 8 | - Power mode : P - Accel dial power : 9 - Power boost solenoid : ON - Power boost pilot lamp : ON - Operating time : max 8 seconds |
| Canceled | Power boost switch : OFF | - Pre-set power mode - Power boost solenoid : OFF - Power boost pilot lamp : OFF |

※ When the auto power boost is set to Enable and power mode is set to P mode on the cluster, the digging power is automatically increased as working conditions by the MCU. It is operated max 8 seconds.

GROUP 5 TRAVEL SPEED CONTROL SYSTEM

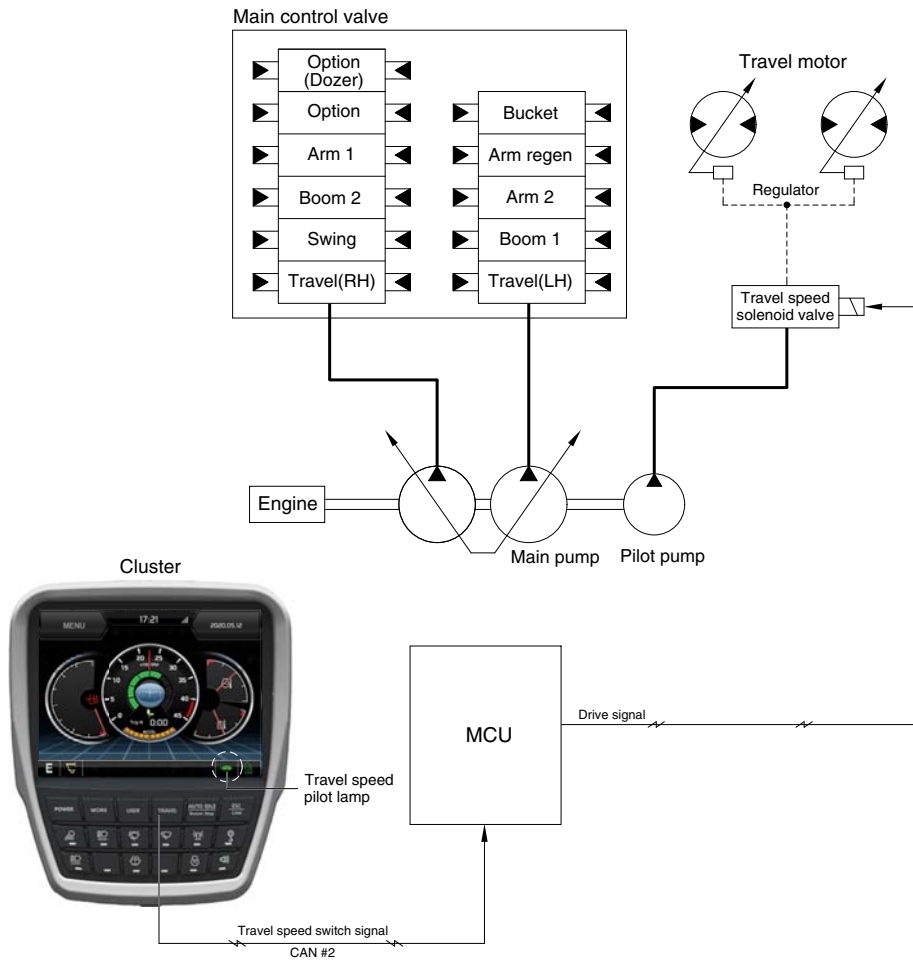

130A5MS07

Travel speed can be switched manually by pressing the travel speed switch on the cluster.

| Speed | Travel speed solenoid valve | Lamp on cluster | Operation |
|-------|-----------------------------|-----------------|--|
| Low | OFF | Turtle | Low speed, high driving torque in the travel motor |
| High | ON | Rabbit | High speed, low driving torque in the travel motor |

※ Default : Turtle (Low speed)

GROUP 6 AUTOMATIC WARMING UP SYSTEM

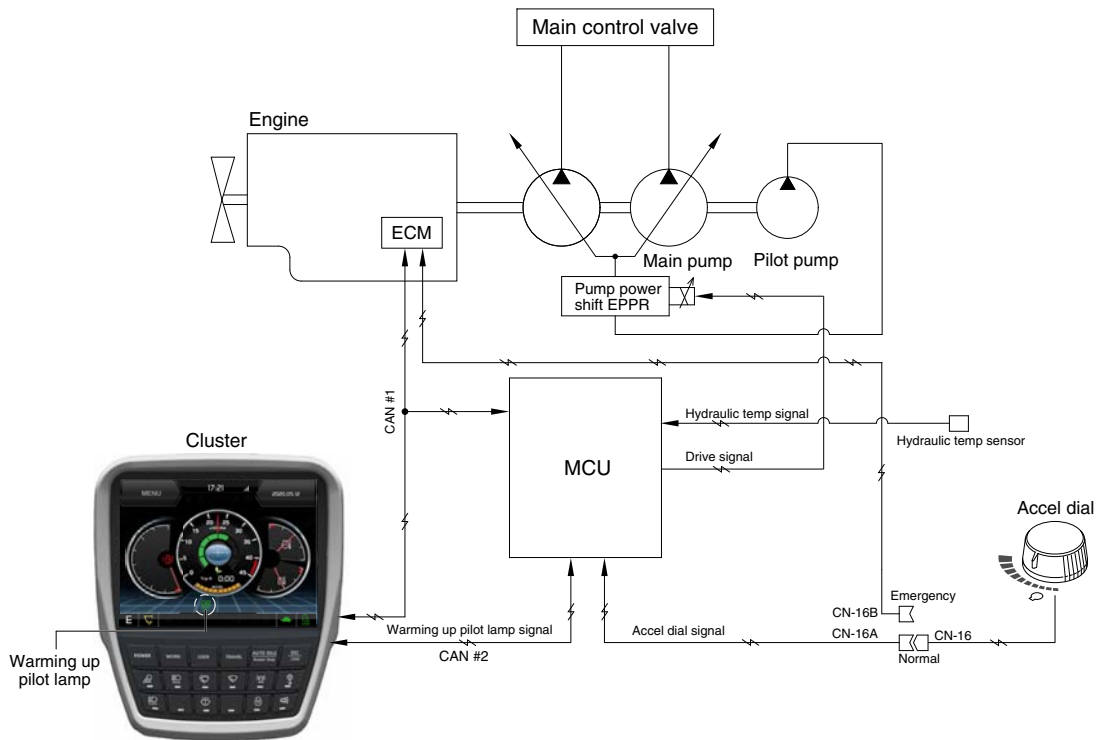

130A5MS08

1. The MCU receives the engine coolant temperature from the ECM, and if the coolant temperature is below 30°C, it increases the engine speed from key start rpm to 1200 rpm. At this time the mode does not change. If the coolant temperature sensor has fault, the hydraulic oil temperature signal is substituted.
2. In case of the coolant temperature increases up to 30°C, the engine speed is decreased to key start speed. And if an operator changes power mode set during the warming up function, the MCU cancels the automatic warming up function.

3. LOGIC TABLE

| Description | Condition | Function |
|-------------|---|---|
| Actuated | - Coolant temperature : Below 30°C (after engine run) | - Power mode : Default (E mode) - Warming up time : 10 minutes (max) - Warming up pilot lamp : ON |
| Canceled | - Coolant temperature : Above 30°C - Warming up time : Above 10 minutes - Changed power mode set by operator - RCV lever or pedal operating - Auto idle cancel ※ If any of the above conditions is applicable, the automatic warming up function is canceled | - Power mode : set mode - Warming up pilot lamp : OFF |

GROUP 7 ENGINE OVERHEAT PREVENTION SYSTEM

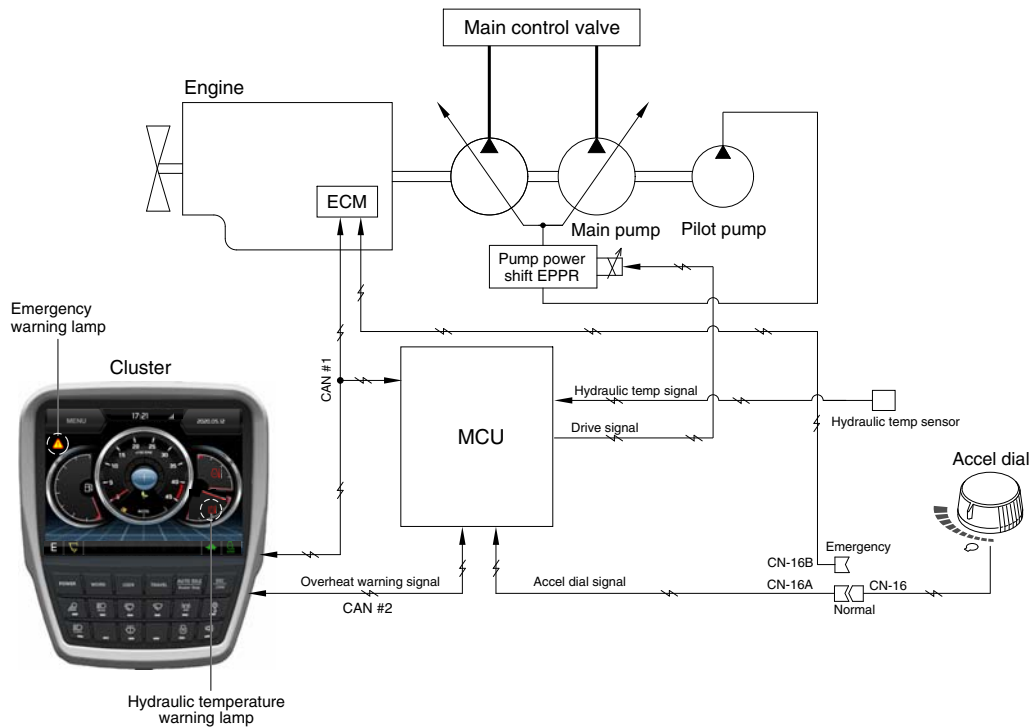

130A5MS09

1. If the engine coolant temperature overheated over 103°C or the hydraulic oil temperature overheated over 100°C is overheated over set temperature, the warning lamp is ON and the pump input torque or the engine speed is reduced as below logic table.

2. LOGIC TABLE

| Description | | Condition | Function |
|---------------------|-----------|--|---|
| First step warning | Activated | - Coolant temperature : Above 103°C - Hydraulic oil temperature : Above 100°C | - Warning lamp : Pops up and buzzer sounds. - Pump input torque is reduced. |
| | Canceled | - Coolant temperature : Less than 100°C - Hydraulic oil temperature : Less than 95°C | - Return to pre-set the pump absorption torque. |
| Second step warning | Activated | - Coolant temperature : Above 107°C - Hydraulic oil temperature : Above 105°C | - Emergency warning lamp pops up on the center of LCD and the buzzer sounds. - Engine speed is reduced after 10 seconds. |
| | Canceled | - Coolant temperature : Less than 103°C - Hydraulic oil temperature : Less than 100°C | - Return to pre-set the engine speed. - Hold pump absorption torque on the first step warning. |

GROUP 8 NEW VARIABLE POWER CONTROL SYSTEM

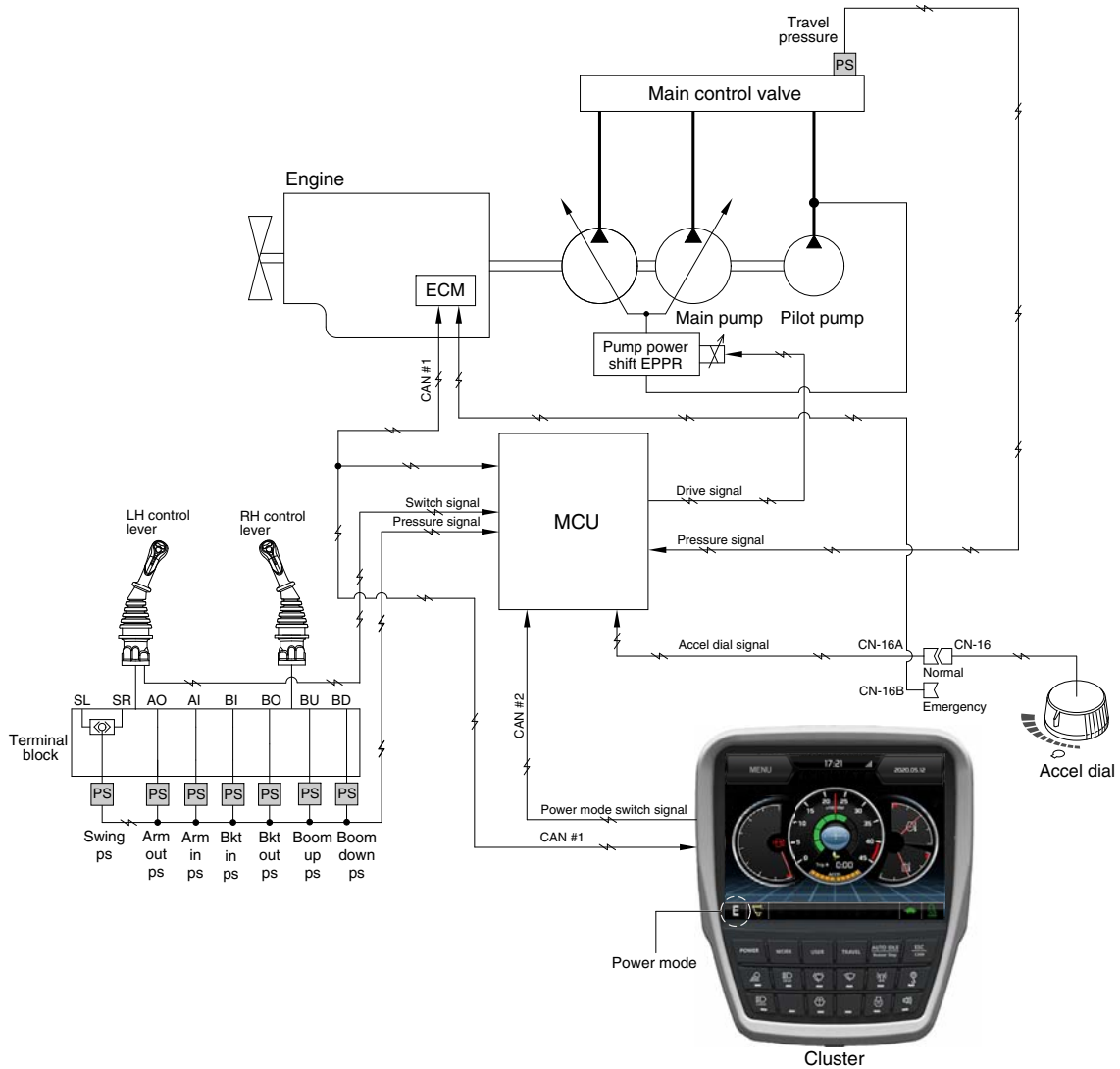

130A5MS10

- The new variable power control system makes constantly exact pump control through improvement variable engine speed control and response and optimization of control input sensor signal.

It makes fuel saving and smooth control at precise work.

| Description | Function | |
|--------------|------------------------------------|--------------------|
| | Stand by | Working |
| Engine speed | - 100 ~ 150 rpm lower than working | - Set rpm |
| Pump EPPR | - 13 bar | - 8 bar |
| Pump flow | - Lower than working | - Normal pump flow |

※ The variable power control function can be activated at all of the power mode.

GROUP 9 ATTACHMENT FLOW CONTROL SYSTEM

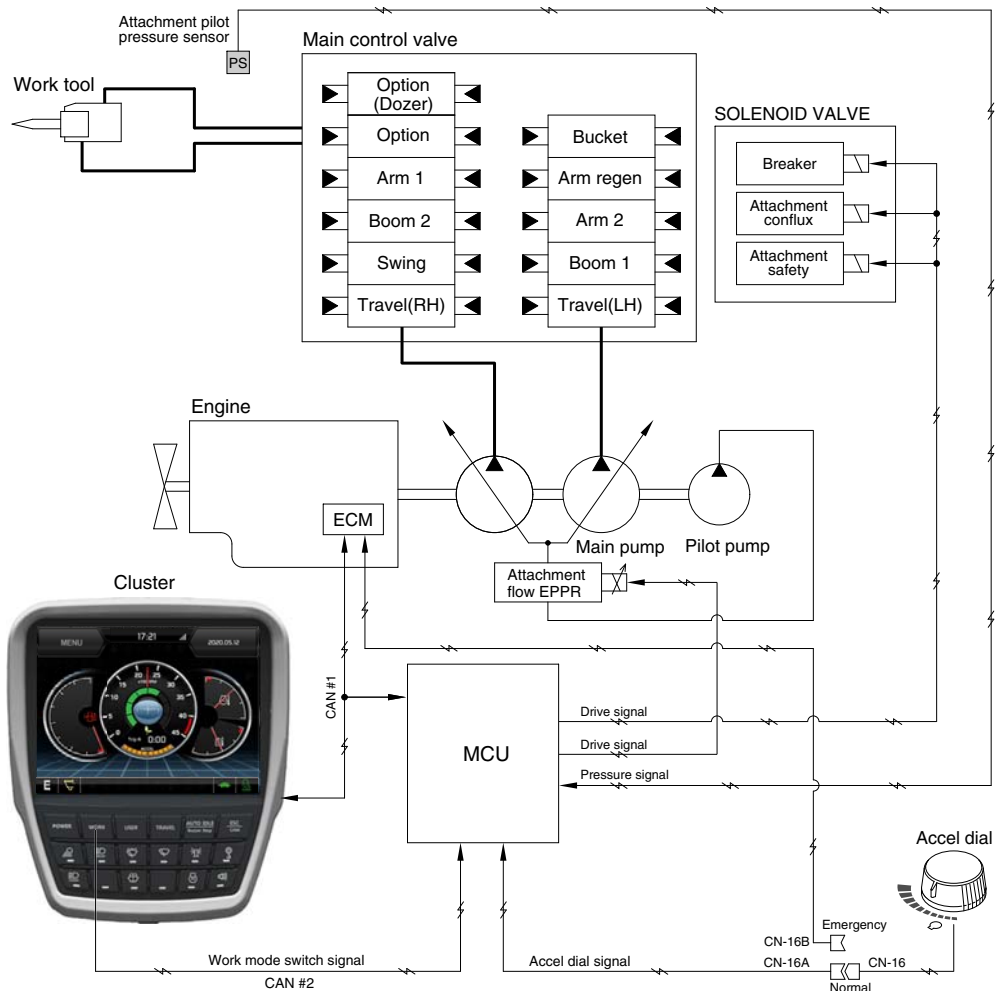

130A5MS11

- The system is used to control the pump delivery flow according to set of the work tool on the cluster by the attachment flow EPPR valve.

| Description | Work tool | |
|-------------------------|---------------|---------------|
| | Breaker | Crusher |
| Flow level | 100 ~ 180 lpm | 100 ~ 440 lpm |
| Attach safety solenoid | - | ON |
| Attach conflux solenoid | ON/OFF | ON/OFF |
| Breaker solenoid★ | ON | - |

※ Refer to the page 5-86 for the attachment kinds and max flow.

★ When breaker operating switch is pushed.

GROUP 10 INTELLIGENT POWER CONTROL SYSTEM

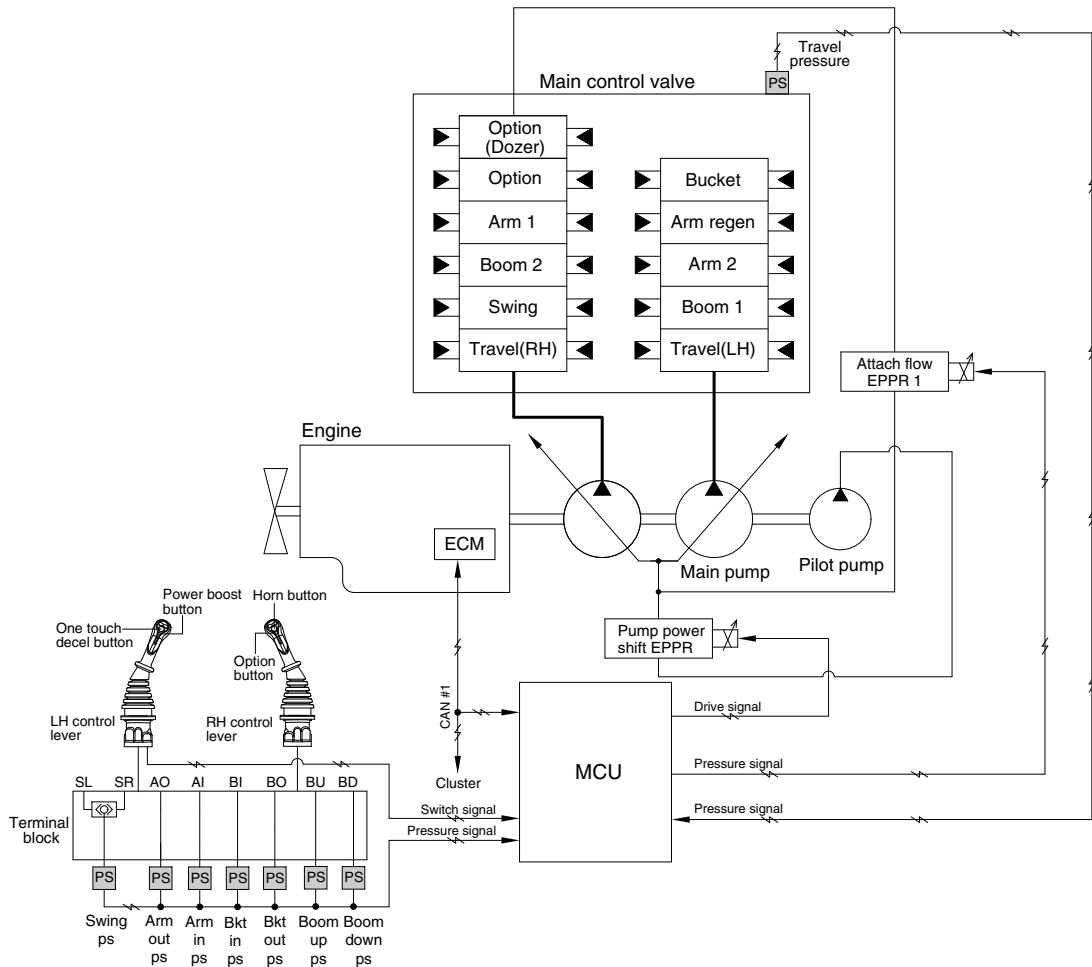

130A5MS13A

1. When the requirement of pump flow rate is low, IPC mode controls pump flow rate to improve fuel efficiency.

| Condition ^{★1} | Function |
|---|--|
| IPC mode : ON ^{★2} Boom up Arm in Not travel motion Not swing motion | Limitation of pump flow rate : Activated |
| None of upper condition | Limitation of pump flow rate : Canceled |

★1 AND condition

★2 IPC mode ON/OFF is selected at "Mode setup > IPC mode". See next page.

2. IPC MODE SELECTION

IPC mode ON/OFF and the levels of flow rate limit can be selected at "Mode setup > IPC mode"



235A3CD52A

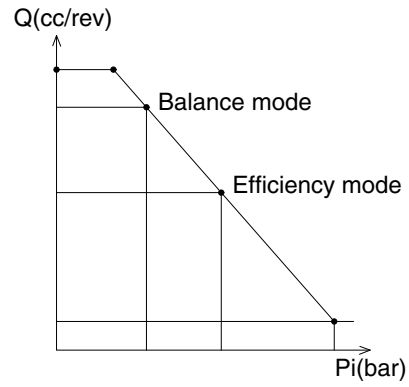

130ZF5MS19

| IPC mode | Description |
|------------------------|----------------------------|
| Balance mode (default) | IPC mode ON, limit level 1 |
| Efficiency mode | IPC mode ON, limit level 2 |
| Speed mode | IPC mode OFF |

GROUP 11 ANTI-RESTART SYSTEM

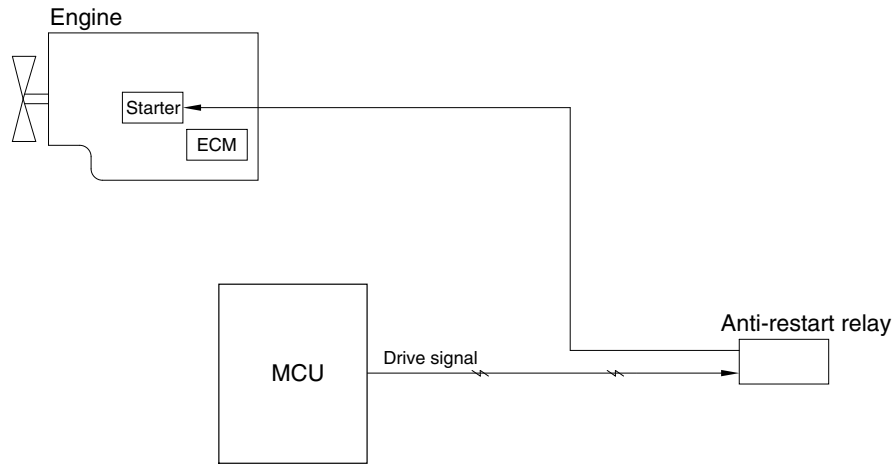

130A5MS12

1. ANTI-RESTART FUNCTION

After a few seconds from the engine starts to run, MCU turns off the anti-restart relay to protect the starter from inadvertent restarting.

GROUP 12 SELF-DIAGNOSTIC SYSTEM

1. OUTLINE

When any abnormality occurs in the ADVANCED CAPO system caused by electric parts malfunction and by open or short circuit, the MCU diagnoses the problem and sends the error codes to the cluster and also stores them in the memory.

2. MONITORING

1) Active fault



- The active faults of the MCU, engine ECM can be checked by this menu.

2) Logged fault



- The logged faults of the MCU, engine ECM can be checked by this menu.

3) Delete logged fault



- The logged faults of the MCU, engine ECM can be deleted by this menu.

3. MACHINE ERROR CODES TABLE

| DTC | | Diagnostic Criteria | Application | | |
|--------|---|--|-------------|---|---|
| HCESPN | FMI | | G | C | W |
| 101 | 3 | 10 seconds continuous, Hydraulic Oil Temp. Measurement Voltage > 3.8V | ● | | |
| | 4 | 10 seconds continuous, Hydraulic Oil Temp. Measurement Voltage < 0.3V | ● | | |
| | (Results / Symptoms) 1. Monitor – Hydraulic oil temperature display failure 2. Control Function – Fan revolutions control failure (Checking list) 1. CD-1 (#2), CN-51 (#16) Checking Open/Short 2. CD-1 (#1), CN-51 (#24) Checking Open/Short | | | | |
| 105 | 0 | 10 seconds continuous, Working Press. Sensor Measurement Voltage > 5.2V | ● | | |
| | 1 | 10 seconds continuous, $0.3V \leq$ Working Press. Sensor Measurement Voltage < 0.8V | ● | | |
| | 4 | 10 seconds continuous, Working Press. Sensor Measurement Voltage < 0.3V | ● | | |
| | (Results / Symptoms) 1. Monitor – Working Press. display failure 2. Control Function – Auto Idle operation failure, Engine variable horse power control operation failure (Checking list) 1. CD-7 (#B) – CN-52 (#19) Checking Open/Short 2. CD-7 (#A) – CN-51 (#32) Checking Open/Short 3. CD-7 (#C) – CN-51 (#31) Checking Open/Short | | | | |
| 108 | 0 | 10 seconds continuous, Travel Oil Press. Sensor Measurement Voltage > 5.2V | | ● | |
| | 1 | 10 seconds continuous, $0.3V \leq$ Travel Oil Press. Sensor Measurement Voltage < 0.8V | ● | | |
| | 4 | 10 seconds continuous, Travel Oil Press. Sensor Measurement Voltage < 0.3V | ● | | |
| | (Results / Symptoms) 1. Monitor – Travel Oil Press. display failure 2. Control Function – Auto Idle operation failure, Engine variable horse power control operation failure, IPC operation failure, Driving alarm operation failure (Checking list) 1. CD-6 (#B) – CN-52 (#27) Checking Open/Short 2. CD-6 (#A) – CN-51 (#32) Checking Open/Short 3. CD-6 (#C) – CN-51 (#31) Checking Open/Short | | | | |

※ Some error codes are not applied to this machine.

G : General

C : Crawler Type

W : Wheel Type

| DTC | | Diagnostic Criteria | Application | | |
|--------|--|--|-------------|---|---|
| HCESPN | FMI | | G | C | W |
| 120 | 0 | 10 seconds continuous, Main Pump 1 (P1) Press. Sensor Measurement Voltage > 5.2V | ● | | |
| | 1 | 10 seconds continuous, $0.3V \leq$ Main Pump 1 (P1) Press. Sensor Measurement Voltage < 0.8V | ● | | |
| | 4 | 10 seconds continuous, Main Pump 1 (P1) Press. Sensor Measurement Voltage < 0.3V | ● | | |
| | (Results / Symptoms) 1. Monitor – Main Pump 1 (P1) Press. display failure 2. Control Function – Automatic voltage increase operation failure, Overload at compensation control failure (Checking list) 1. CD-42 (#B) – CN-52 (#22) Checking Open/Short 2. CD-42 (#A) – CN-51 (#32) Checking Open/Short 3. CD-42 (#C) – CN-51 (#31) Checking Open/Short | | | | |
| 121 | 0 | 10 seconds continuous, Main Pump 2 (P2) Press. Sensor Measurement Voltage > 5.2V | ● | | |
| | 1 | 10 seconds continuous, $0.3V \leq$ Main Pump 2 (P2) Press. Sensor Measurement Voltage < 0.8V | ● | | |
| | 4 | 10 seconds continuous, Main Pump 2 (P2) Press. Sensor Measurement Voltage < 0.3V | ● | | |
| | (Results / Symptoms) 1. Monitor – Main Pump 2 (P2) Press. display failure 2. Control Function – Automatic voltage increase operation failure, Overload at compensation control failure (Checking list) 1. CD-43 (#B) – CN-52 (#14) Checking Open/Short 2. CD-43 (#A) – CN-51 (#32) Checking Open/Short 3. CD-43 (#C) – CN-51 (#31) Checking Open/Short | | | | |
| 122 | 1 | (when you had conditions mounting pressure sensor) 10 seconds continuous, $0.3V \leq$ Overload Press. Sensor Measurement Voltage < 0.8V | ● | | |
| | 4 | (when you had conditions mounting pressure sensor) 10 seconds continuous, Overload Press. Sensor Measurement Voltage < 0.3V | ● | | |
| | (Results / Symptoms) 1. Monitor – Overload Press. display failure 2. Control Function – Overload warning alarm failure (Checking list) 1. CD-31 (#B) – CN-52 (#28) Checking Open/Short 2. CD-31 (#A) – CN-51 (#32) Checking Open/Short 3. CD-31 (#C) – CN-51 (#31) Checking Open/Short | | | | |

※ Some error codes are not applied to this machine.

G : General

C : Crawler Type

W : Wheel Type

| DTC | | Diagnostic Criteria | Application | | |
|--------|--|--|-------------|---|---|
| HCESPN | FMI | | G | C | W |
| 123 | 0 | 10 seconds continuous, Negative 1 Press. Sensor Measurement Voltage > 5.2V | ● | | |
| | 1 | 10 seconds continuous, 0.3V ≤ Negative 1 Press. Sensor Measurement Voltage < 0.8V | ● | | |
| | 4 | 10 seconds continuous, Negative 1 Press. Sensor Measurement Voltage < 0.3V | ● | | |
| | (Results / Symptoms) 1. Monitor – Negative 1 Press. display failure 2. Control Function – IPC operation failure, Option attachment flow control operation failure (Checking list) 1. CD-70 (#B) – CN-51 (#22) Checking Open/Short 2. CD-70 (#A) – CN-51 (#32) Checking Open/Short 3. CD-70 (#C) – CN-51 (#31) Checking Open/Short | | | | |
| 124 | 0 | 10 seconds continuous, Negative 2 Press. Sensor Measurement Voltage > 5.2V | ● | | |
| | 1 | 10 seconds continuous, 0.3V ≤ Negative 2 Press. Sensor Measurement Voltage < 0.8V | ● | | |
| | 4 | 10 seconds continuous, Negative 2 Press. Sensor Measurement Voltage < 0.3V | ● | | |
| | (Results / Symptoms) 1. Monitor – Negative 2 Press. display failure 2. Control Function – Option attachment flow control operation failure (Checking list) 1. CD-71 (#B) – CN-51 (#28) Checking Open/Short 2. CD-71 (#A) – CN-51 (#32) Checking Open/Short 3. CD-71 (#C) – CN-51 (#31) Checking Open/Short | | | | |
| 127 | 0 | 10 seconds continuous, Boom Up Pilot Press. Sensor Measurement Voltage > 5.2V | ● | | |
| | 1 | 10 seconds continuous, 0.3V ≤ Boom Up Pilot Press. Sensor Measurement Voltage < 0.8V | ● | | |
| | 4 | 10 seconds continuous, Boom Up Pilot Press. Sensor Measurement < 0.3V | ● | | |
| | (Results / Symptoms) 1. Monitor – Boom Up Pilot Press. display failure 2. Control Function – Engine/Pump variable horse power control operation failure, IPC operation failure, Boom first operation failure (Checking list) 1. CD-32 (#B) – CN-52 (#23) Checking Open/Short 2. CD-32 (#A) – CN-51 (#32) Checking Open/Short 3. CD-32 (#C) – CN-51 (#31) Checking Open/Short | | | | |

※ Some error codes are not applied to this machine.

G : General

C : Crawler Type

W : Wheel Type

| DTC | | Diagnostic Criteria | Application | | |
|--------|--|---|-------------|---|---|
| HCESPN | FMI | | G | C | W |
| 128 | 0 | (when you had conditions mounting pressure sensor) 10 seconds continuous, Boom Down Pilot Press. Sensor Measurement Voltage > 5.2V | ● | | |
| | 1 | (when you had conditions mounting pressure sensor) 10 seconds continuous, $0.3V \leq$ Boom Down Pilot Press. Sensor Measurement Voltage < 0.8V | ● | | |
| | 4 | (when you had conditions mounting pressure sensor) 10 seconds continuous, Boom Down Pilot Press. Sensor Measurement Voltage < 0.3V | ● | | |
| | (Results / Symptoms) 1. Monitor – Boom Down Pilot Press. display failure 2. Control Function – Boom floating operation failure (Checking list) 1. CD-85 (#B) – CN-52 (#31) Checking Open/Short 2. CD-85 (#A) – CN-51 (#32) Checking Open/Short 3. CD-85 (#C) – CN-51 (#31) Checking Open/Short | | | | |
| 129 | 0 | 10 seconds continuous, Arm In Pilot Press. Sensor Measurement Voltage > 4.8V | ● | | |
| | 1 | 10 seconds continuous, $0.3V \leq$ Arm In Pilot Press. Sensor Measurement Voltage < 0.8V | ● | | |
| | 4 | 10 seconds continuous, Arm In Pilot Press. Sensor Measurement Voltage < 0.3V | ● | | |
| | (Results / Symptoms) 1. Monitor – Arm In Pilot Press. display failure 2. Control Function – IPC operation failure (Checking list) 1. CD-90 (#B) – CN-51 (#21) Checking Open/Short 2. CD-90 (#A) – CN-51 (#32) Checking Open/Short 3. CD-90 (#C) – CN-51 (#31) Checking Open/Short | | | | |
| 130 | 0 | 10 seconds continuous, Arm Out Pilot Press. Sensor Measurement Voltage > 5.2V | ● | | |
| | 1 | 10 seconds continuous, $0.3V \leq$ Arm Out Pilot Press. Sensor Measurement Voltage < 0.8V | ● | | |
| | 4 | 10 seconds continuous, Arm Out Pilot Press. Sensor Measurement Voltage < 0.3V | ● | | |
| | (Results / Symptoms) 1. Monitor – Arm Out Pilot Press. display failure 2. Control Function – Engine variable horse power control operation failure (Checking list) 1. CD-86 (#B) – CN-51 (#27) Checking Open/Short 2. CD-86 (#A) – CN-51 (#32) Checking Open/Short 3. CD-86 (#C) – CN-51 (#31) Checking Open/Short | | | | |

※ Some error codes are not applied to this machine.

G : General

C : Crawler Type

W : Wheel Type

| DTC | | Diagnostic Criteria | Application | | |
|--------------|--|--|-------------|---|---|
| HCESPN | FMI | | G | C | W |
| 135 | 0 | 10 seconds continuous, Swing Pilot Press. Sensor Measurement Voltage > 5.2V | ● | | |
| | 1 | 10 seconds continuous, 0.3V ≤ Swing Pilot Press. Sensor Measurement Voltage < 0.8V | ● | | |
| | 4 | 10 seconds continuous, Swing Pilot Press. Sensor Measurement Voltage < 0.3V | ● | | |
| | (Results / Symptoms) 1. Monitor – Swing Pilot Press. display failure 2. Control Function – IPC operation, Boom first operation failure (Checking list) 1. CD-24 (#B) – CN-52 (#18) Checking Open/Short 2. CD-24 (#A) – CN-51 (#32) Checking Open/Short 3. CD-24 (#C) – CN-51 (#31) Checking Open/Short | | | | |
| 138 | 0 | Monitor – Select Attachment (breaker / crusher) 10 seconds continuous, Attachment Pilot Press. Sensor Measurement Voltage > 5.2V | ● | | |
| | 1 | Monitor – Select Attachment (breaker / crusher) 10 seconds continuous, 0.3V ≤ Attachment Pilot Press. Sensor Measurement Voltage < 0.8V | ● | | |
| | 4 | Monitor – Select Attachment (breaker / crusher) 10 seconds continuous, Attachment Pilot Press. Sensor Measurement Voltage < 0.3V | ● | | |
| | (Results / Symptoms) 1. Monitor – Attachment Pilot Press. display failure 2. Control Function – Option attachment flow control operation failure (Checking list) 1. CD-69 (#B) – CN-52 (#32) Checking Open/Short 2. CD-69 (#A) – CN-51 (#32) Checking Open/Short 3. CD-69 (#C) – CN-51 (#31) Checking Open/Short | | | | |
| 139 (N.A) | 1 | 10 seconds continuous, 0.3V ≤ Option Pilot Press. Sensor Measurement Voltage < 0.8V | | | ● |
| | 4 | 10 seconds continuous, Option Pilot Press. Sensor Measurement Voltage < 0.3V | | | ● |
| | (Results / Symptoms) 1. Monitor – Option Pilot Press. display failure 2. Control Function – Auto Idle operation failure (Checking list) 1. CD-100 (#B) – CN-52 (#21) Checking Open/Short 2. CD-100 (#A) – CN-51 (#3) Checking Open/Short 3. CD-100 (#C) – CN-1 (#6) Checking Open/Short | | | | |

※ Some error codes are not applied to this machine.

G : General

C : Crawler Type

W : Wheel Type

| DTC | | Diagnostic Criteria | Application | | |
|--------|--|--|-------------|---|---|
| HCESPN | FMI | | G | C | W |
| 140 | 5 | (Detection) (When Pump EPPR Current is more than 10 mA) 10 seconds continuous, Pump EPPR drive current < 0 mA (Cancellation) (When Pump EPPR Current is more than 10 mA) 3 seconds continuous, Pump EPPR drive current ≥ 10 mA | ● | | |
| | 6 | (Detection) 10 seconds continuous, Pump EPPR drive current > 1.0A (Cancellation) 3 seconds continuous, Pump EPPR drive current ≤ 1.0 A | ● | | |
| | (Results / Symptoms) 1. Control Function – Pump horse power setting specification difference (Fuel efficiency/speed specification failure) (Checking list) 1. CN-75 (#2) – CN-54 (#28) Checking Open/Short 2. CN-75 (#1) – CN-54 (#4) Checking Open/Short | | | | |
| 141 | 5 | (Model Parameter) mounting Boom Priority EPPR (Detection) (When Boom Priority EPPR Current is more than 10 mA) 10 seconds continuous, Boom Priority EPPR drive current < 0 mA (Cancellation) (When Boom Priority EPPR Current is more than 10 mA) 3 seconds continuous, Boom Priority EPPR drive current ≥ 10 mA | ● | | |
| | 6 | (Detection) 10 seconds continuous, Boom Priority EPPR drive current > 1.0 A (Cancellation) 3 seconds continuous, Boom Priority EPPR drive current ≤ 1.0 A | ● | | |
| | (Results / Symptoms) 1. Control Function – Boom first control operation failure (Checking list) 1. CN-133 (#2) – CN-54 (#34) Checking Open/Short 2. CN-133 (#1) – CN-54 (#4) Checking Open/Short | | | | |

※ Some error codes are not applied to this machine.

G : General

C : Crawler Type

W : Wheel Type

| DTC | | Diagnostic Criteria | Application | | |
|--------------|--|--|-------------|---|---|
| HCESPN | FMI | | G | C | W |
| 143 (N.A) | 5 | (Detection) (When Travel EPPR Current is more than 10 mA) 10 seconds continuous, Travel EPPR drive current = 0 mA (Cancellation) (When Travel EPPR Current is more than 100 mA) 3 seconds continuous, Travel EPPR drive current \geq 10 mA | | | ● |
| | 6 | (Detection) 10 seconds continuous, Travel EPPR drive current > 1.0 A (Cancellation) 3 seconds continuous, Travel EPPR drive current \leq 1.0 A | | | ● |
| | (Results / Symptoms) 1. Control Function – cruise control operation failure (Checking list) 1. CN-246 (#2) – CN-54 (#39) Checking Open/Short 2. CN-246 (#1) – CN-51 (#40) Checking Open/Short | | | | |
| 145 (N.A) | 5 | (Model Parameter) mounting Remote Cooling Fan EPPR (Detection) (When Remote Cooling Fan EPPR Current is more than 10 mA) 10 seconds continuous, Remote Cooling Fan EPPR drive current = 0 mA (Cancellation) (When Remote Cooling Fan EPPR Current is more than 10 mA) 3 seconds continuous, Remote Cooling Fan EPPR drive current \geq 10 mA | ● | | |
| | 6 | (Detection) 10 seconds continuous, Remote Cooling Fan EPPR drive current > 1.0 A (Cancellation) 3 seconds continuous, Remote Cooling Fan EPPR drive current \leq 1.0 A | ● | | |
| | (Results / Symptoms) 1. Control Function – Remote fan control operation failure (Checking list) 1. CD-52 (#1) – CN-51 (#9) Checking Open/Short 2. CD-52 (#2) – CN-51 (#14) Checking Open/Short | | | | |

※ Some error codes are not applied to this machine.

G : General C : Crawler Type W : Wheel Type

| DTC | | Diagnostic Criteria | Application | | |
|--|-----|---|-------------|---|---|
| HCESPN | FMI | | G | C | W |
| 164 (N.A) | 4 | (Detection) (When Working Cutoff Relay is Off) 10 seconds continuous, Working Cutoff Relay drive unit Measurement Voltage $\leq 3.0V$ (Cancellation) (When Working Cutoff Relay is Off) 3 seconds continuous, Working Cutoff Relay drive unit Measurement Voltage $> 3.0V$ | | | ● |
| | 6 | (Detection) (When Working Cutoff Relay is On) 10 seconds continuous, Working Cutoff Relay drive current $> 6.5 A$ (Cancellation) (When Working Cutoff Relay is On) 3 seconds continuous, Working Cutoff Relay drive current $\leq 6.5 A$ | | | ● |
| (Results / Symptoms) 1. Control Function – (Wheel Excavator) In driving mode, attachment hydraulic pilot pressure cut off failure (Checking list) 1. CR-47 (#85) – CN-54 (#9) Checking Open/Short 2. CR-47 (#30, #86) – CN-45 (#B+ term) Checking Open/Short | | | | | |
| 166 | 4 | (Detection) (When Power Max Solenoid is Off) 10 seconds continuous, Power Max Solenoid drive unit Measurement Voltage $\leq 3.0V$ (Cancellation) (When Power Max Solenoid is Off) 3 seconds continuous, Power Max Solenoid drive unit Measurement Voltage $> 3.0V$ | ● | | |
| | 6 | (Detection) (When Power Max Solenoid is On) 5 seconds continuous, Power Max Solenoid drive current $> 4.5 A$ (Cancellation) (When Power Max Solenoid is On) 3 seconds continuous, Power Max Solenoid drive current $\leq 4.5 A$ | ● | | |
| (Results / Symptoms) 1. Control Function – Voltage increase operation failure (Checking list) 1. CN-88 (#1) – CN-53 (#13) Checking Open/Short 2. CN-88 (#2) – Fuse box (#24) Checking Open/Short | | | | | |

※ Some error codes are not applied to this machine.

G : General

C : Crawler Type

W : Wheel Type

| DTC | | Diagnostic Criteria | Application | | |
|--------|--|---|-------------|---|---|
| HCESPN | FMI | | G | C | W |
| 167 | | (Detection) (When Travel Speed Solenoid is Off) 10 seconds continuous, Travel Speed Solenoid drive unit Measurement Voltage \leq 3.0V (Cancellation) (When Travel Speed Solenoid is Off) 3 seconds continuous, Travel Speed Solenoid drive unit Measurement Voltage $>$ 3.0V | | ● | |
| | 4 | (When Parking mode is not) (Detection) (When Travel Speed Solenoid is Off) 10 seconds continuous, Travel Speed Solenoid drive unit Measurement Voltage \leq 3.0V (Cancellation) (When Travel Speed Solenoid is Off) 3 seconds continuous, Travel Speed Solenoid drive unit Measurement Voltage $>$ 3.0V | | | ● |
| | 6 | (Detection) (When Travel Speed Solenoid is On) 10 seconds continuous, Travel Speed Solenoid drive current $>$ 4.5 A (Cancellation) (When Travel Speed Solenoid is On) 3 seconds continuous, Travel Speed Solenoid drive current \leq 4.5 A | ● | | |
| | (Results / Symptoms) 1. Control Function – driving in 1/2 transmission operation failure (Checking list) 1. CN-70 (#1) – CN-52 (#5) Checking Open/Short 2. CN-70 (#2) – Fuse box (#24) Checking Open/Short | | | | |

※ Some error codes are not applied to this machine.

G : General

C : Crawler Type

W : Wheel Type

| DTC | | Diagnostic Criteria | Application | | |
|--|-----|---|-------------|---|---|
| HCESPN | FMI | | G | C | W |
| 169 | 4 | Monitor – Selecting attachment (breaker / crusher) (Detection) (When Attachment Conflux Solenoid is Off) 10 seconds continuous, Attachment Conflux Solenoid drive unit Measurement Voltage \leq 3.0V (Cancellation) (When Attachment Conflux Solenoid is Off) 3 seconds continuous, Attachment Conflux Solenoid drive unit Measurement Voltage $>$ 3.0V | ● | | |
| | 6 | (Detection) (When Attachment Conflux Solenoid is On) 10 seconds continuous, Attachment Conflux Solenoid drive Current $>$ 6.5 A (Cancellation) (When Attachment Conflux Solenoid is On) 3 seconds continuous, Attachment Conflux Solenoid drive Current \leq 6.5 A | ● | | |
| (Results / symptoms) 1. Control Function – Option attachment flow control – Joining operation failure (Eco breaker mode, crusher mode) (Checking list) 1. CN-237 (#1) – CN-52 (#16) Checking Open/Short 2. CN-237 (#2) – Fuse box (#24) Checking Open/Short | | | | | |
| 170 | 4 | (Model Parameter) mounting Arm Regenerating Solenoid (Detection) (When Arm Regeneration Solenoid is Off) 10 seconds continuous, Arm Regeneration Solenoid drive unit Measurement Voltage \leq 3.0V (Cancellation) (When Arm Regeneration Solenoid is Off) 3 seconds continuous, Arm Regeneration Solenoid drive unit Measurement Voltage $>$ 3.0V | ● | | |
| | 6 | (Detection) (When Arm Regeneration Solenoid is On) 10 seconds continuous, Arm Regeneration Solenoid drive current $>$ 4.5 A (Cancellation) (When Arm Regeneration Solenoid is On) 3 seconds continuous, Arm Regeneration Solenoid drive current \leq 4.5 A | ● | | |
| (Results / symptoms) 1. Control Function – Arm regeneration operation failure (Checking list) 1. CN-135 (#1) – CN-52 (#7) Checking Open/Short 2. CN-135 (#2) – Fuse box (#24) Checking Open/Short | | | | | |

※ Some error codes are not applied to this machine.

G : General

C : Crawler Type

W : Wheel Type

| DTC | | Diagnostic Criteria | Application | | |
|--|-----|---|-------------|---|---|
| HCESPN | FMI | | G | C | W |
| 171 | 4 | Monitor – Selecting attachment (crusher) (Detection) (When Attachment Safety Solenoid is Off) 10 seconds continuous, Attachment Safety Solenoid drive unit Measurement Voltage \leq 3.0V (Cancellation) (When Attachment Safety Solenoid is Off) 3 seconds continuous, Attachment Safety Solenoid drive unit Measurement Voltage $>$ 3.0V | ● | | |
| | 6 | (Detection) (When Attachment Safety Solenoid is On) 10 seconds continuous, Attachment Safety Solenoid drive current $>$ 6.5 A (Cancellation) (When Attachment Safety Solenoid is On) 3 seconds continuous, Attachment Safety Solenoid drive current \leq 6.5 A | ● | | |
| (Results / Symptoms) 1. Control Function – Option attachment flow control – Option spool pilot pressure cut off failure (crusher mode) (Checking list) 1. CN-149 (#1) – CN-53 (#9) Checking Open/Short 2. CN-149 (#2) – Fuse box (#24) Checking Open/Short | | | | | |
| 179 | 4 | Monitor – Selecting attachment (breaker / crusher) (Detection) (When Breaker Operating Solenoid is Off) 10 seconds continuous, Attachment Safety Solenoid drive unit Measurement Voltage \leq 3.0V (Cancellation) (When Breaker Operating Solenoid is Off) 3 seconds continuous, Attachment Safety Solenoid drive unit Measurement Voltage $>$ 3.0V | ● | | |
| | 6 | (Detection) (When Breaker Operating Solenoid is On) 10 seconds continuous, Attachment Safety Solenoid drive current $>$ 6.5 A (Cancellation) (When Breaker Operating Solenoid is On) 3 seconds continuous, Attachment Safety Solenoid drive current \leq 6.5 A | ● | | |
| (Results / Symptoms) 1. Control Function – Option attachment flow control – Breaker operation failure (breaker mode) (Checking list) 1. CN-66 (#1) – CN-53 (#8) Checking Open/Short 2. CN-66 (#2) – Fuse box (#24) Checking Open/Short | | | | | |

※ Some error codes are not applied to this machine.

G : General

C : Crawler Type

W : Wheel Type

| DTC | | Diagnostic Criteria | Application | | |
|---|-----|--|-------------|---|---|
| HCESPN | FMI | | G | C | W |
| 181 (N.A) | 4 | (Model Parameter) mounting Reverse Cooling Fan Solenoid (Detection) (When Reverse Cooling Fan Solenoid is Off) 10 seconds continuous, Reverse Cooling Fan Solenoid drive unit Measurement Voltage \leq 3.0V (Cancellation) (When Reverse Cooling Fan Solenoid is Off) 3 seconds continuous, Reverse Cooling Fan Solenoid drive unit Measurement Voltage $>$ 3.0V | ● | | |
| | 6 | (Detection) (When Reverse Cooling Fan Solenoid is On) 10 seconds continuous, Reverse Cooling Fan Solenoid drive current $>$ 4.5 A (Cancellation) (When Reverse Cooling Fan Solenoid is On) 3 seconds continuous, Reverse Cooling Fan Solenoid drive current \leq 4.5 A | ● | | |
| (Results / Symptoms) 1. Control Function – Cooling Fan reverse control operation failure (not applicable) | | | | | |
| 188 | 5 | (Detection) (When Attachment Flow EPPR 1 current is equal or more than 300 mA) 10 seconds continuous, Attachment Flow EPPR drive current $<$ 100 mA (Cancellation) (When Attachment Flow EPPR 1 current is equal or more than 300 mA) 3 seconds continuous, Attachment Flow EPPR drive current \geq 100 mA | ● | | |
| | 6 | (Detection) 10 seconds continuous, Attachment Flow EPPR 1 drive current $>$ 1.0 A (Cancellation) 3 seconds continuous, Attachment Flow EPPR 1 drive current \leq 1.0 A | ● | | |
| (Results / Symptoms) 1. Control Function – IPC operation failure, Option attachment flow control operation failure (Checking list) 1. CN-242 (#2) – CN-54 (#27) Checking Open/Short 2. CN-242 (#1) – CN-54 (#2) Checking Open/Short | | | | | |

※ Some error codes are not applied to this machine.

G : General

C : Crawler Type

W : Wheel Type

| DTC | | Diagnostic Criteria | Application | | |
|---|--|--|-------------|---|---|
| HCESPN | FMI | | G | C | W |
| 189 | 5 | (Detection) (When Attachment Flow EPPR 2 current is equal or more than 300 mA) 10 seconds continuous, Attachment Flow EPPR drive current < 100 mA (Cancellation) (When Attachment Flow EPPR 2 current is equal or more than 300 mA) 3 seconds continuous, Attachment Flow EPPR drive current ≥ 100 mA | ● | | |
| | 6 | (Detection) 10 seconds continuous, Attachment Flow EPPR 2 drive current > 1.0 A (Cancellation) 3 seconds continuous, Attachment Flow EPPR 2 drive current ≤ 1.0 A | ● | | |
| (Results / Symptoms) 1. Control Function – Option attachment flow control operation failure (Checking list) 1. CN-378 (#2) – CN-54 (#26) Checking Open/Short 2. CN-378 (#1) – CN-54 (#3) Checking Open/Short | | | | | |
| 196 (N.A) | 0 | HW145 10 seconds continuous, Attachment flow control EPPR 1 press. Sensor Measurement Voltage > 5.2V | | | |
| | 1 | HW145 10 seconds continuous, 0.3V ≤ Attachment flow control EPPR 1 press. Sensor Measurement Voltage < 0.8V | | | |
| | 4 | HW145 10 seconds continuous, Attachment flow control EPPR 1 press. Sensor Measurement Voltage < 0.3V | | | |
| (Results / Symptoms) 1. Control Function – Driving second pump joining function operation failure (Checking list) 1. CD-33 (#B) – CN-52 (#11) Checking Open/Short 2. CD-33 (#A) – CN-51 (#3) Checking Open/Short 3. CD-33 (#C) – CN-51 (#13) Checking Open/Short | | | | | |
| 200 | 0 | 10 seconds continuous, Pump EPPR Press. Sensor Measurement Voltage > 5.2V | ● | | |
| | 1 | 10 seconds continuous, 0.3V ≤ Pump EPPR Press. Sensor Measurement Voltage < 0.8V | ● | | |
| | 4 | 10 seconds continuous, Pump EPPR Press. Sensor Measurement Voltage < 0.3V | ● | | |
| | (Results / Symptoms) 1. Monitor – Pump EPPR Press. display failure 2. Control Function – Pump input horse power control failure, Overload at compensation control operation failure (Fuel efficiency/speed performance failure) (Checking list) 1. CD-44 (#B) – CN-51 (#13) Checking Open/Short 2. CD-44 (#A) – CN-51 (#32) Checking Open/Short 3. CD-44 (#C) – CN-51 (#31) Checking Open/Short | | | | |

※ Some error codes are not applied to this machine.

G : General

C : Crawler Type

W : Wheel Type

| DTC | | Diagnostic Criteria | Application | | |
|--------------|---|--|-------------|---|---|
| HCESPN | FMI | | G | C | W |
| 205 (N.A) | 0 | (Mounting pressure sensor) 10 seconds continuous, Boom Cylinder Rod Press. Sensor Measurement Voltage > 5.2V | ● | | |
| | 1 | (Mounting pressure sensor) 10 seconds continuous, 0.3V ≤ Boom Cylinder Rod Press. Sensor Measurement Voltage < 0.8V | ● | | |
| | 4 | (Mounting pressure sensor) 10 seconds continuous, Boom Cylinder Rod Press. Sensor Measurement Voltage < 0.3V | ● | | |
| | (Results / Symptoms) 1. Monitor – Boom Cylinder Rod Press. display failure 2. Control Function – Boom floating control operation failure (Checking list) 1. CD-124 (#B) – CN-53 (#5) Checking Open/Short 2. CD-124 (#A) – CN-53 (#3) Checking Open/Short 3. CD-124 (#C) – CN-53 (#13) Checking Open/Short | | | | |
| 218 (N.A) | 4 | Mounting pressure sensor (HCESPN128 or HCESPN 205) (Detection) (When Boom Up Floating Solenoid is Off) 10 seconds continuous, Boom Up Floating Solenoid drive unit Measurement Voltage ≤ 3.0V (Cancellation) (When Boom Up Floating Solenoid is Off) 3 seconds continuous, Boom Up Floating Solenoid drive unit Measurement Voltage > 3.0V | ● | | |
| | 6 | (Detection) (When Boom Up Floating Solenoid is On) 10 seconds continuous, Boom Up Floating Solenoid drive current > 6.5 A (Cancellation) (When Boom Up Floating Solenoid is On) 3 seconds continuous, Boom Up Floating Solenoid drive current ≤ 6.5 A | ● | | |
| | (Results / Symptoms) 1. Control Function – Boom floating control operation failure (Checking list) 1. CD-368 (#1) – CN-53 (#20) Checking Open/Short 2. CD-368 (#2) – CR-35 (#87) Checking Open/Short | | | | |

※ Some error codes are not applied to this machine.

G : General

C : Crawler Type

W : Wheel Type

| DTC | | Diagnostic Criteria | Application | | |
|---|-----|---|-------------|---|---|
| HCESPN | FMI | | G | C | W |
| 220 (N.A) | 4 | Mounting pressure sensor (HCESPN 128 or 205) (Detection) (When Boom Down Pilot Pressure Cutoff Solenoid is Off) 10 seconds continuous, Boom Down Pilot Pressure Cutoff Solenoid drive unit Measurement Voltage \leq 3.0V (Cancellation) (When Boom Down Pilot Pressure Cutoff Solenoid is Off) 3 seconds continuous, Boom Down Pilot Pressure Cutoff Solenoid drive unit Measurement Voltage $>$ 3.0V | ● | | |
| | 6 | (Detection) (When Boom Down Pilot Pressure Cutoff Solenoid is On) 10 seconds continuous, Boom Down Pilot Pressure Cutoff Solenoid drive current $>$ 6.5 A (Cancellation) (When Boom Down Pilot Pressure Cutoff Solenoid is On) 3 seconds continuous, Boom Down Pilot Pressure Cutoff Solenoid drive current \leq 6.5 A | ● | | |
| (Results / Symptoms) 1. Control Function – Boom floating control operation failure (Checking list) 1. CD-369 (#1) – CN-53 (#35) Checking Open/Short 2. CD-369 (#2) – CR-35 (#87) Checking Open/Short | | | | | |
| 221 | 5 | Monitor – Selecting attachment (breaker / crusher) (Detection) (When ATT Relief Setting EPPR 1 Current is equal or more than 10 mA) 10 seconds continuous, ATT Relief Setting EPPR 1 drive current = 0 mA (Cancellation) ATT Relief Setting EPPR 1 Current is equal or more than 10 mA) 3 seconds continuous, ATT Relief Setting EPPR 1 drive current \geq 10 mA | ● | | |
| | 6 | (Detection) 10 seconds continuous, ATT Relief Setting EPPR 1 drive current $>$ 1.0 A (Cancellation) 3 seconds continuous, ATT Relief Setting EPPR 1 drive current \leq 1.0 A | ● | | |
| (Results / Symptoms) 1. Control Function – Option attachment flow control – P1 relief pressure setting failure (Checking list) 1. CN-365 (#2) – CN-54 (#17) Checking Open/Short 2. CN-365 (#1) – CN-54 (#9) Checking Open/Short | | | | | |

※ Some error codes are not applied to this machine.

G : General

C : Crawler Type

W : Wheel Type

| DTC | | Diagnostic Criteria | Application | | |
|--|--|--|-------------|---|---|
| HCESPN | FMI | | G | C | W |
| 222 | 5 | Monitor – Selecting attachment (crusher) (Detection) (When ATT Relief Setting EPPR 2 Current is equal or more than 10 mA) 10 seconds continuous, ATT Relief Setting EPPR 2 drive current = 0 mA (Cancellation) (When ATT Relief Setting EPPR 2 Current is equal or more than 10 mA) 3 seconds continuous, ATT Relief Setting EPPR 2 drive current ≥ 10mA | ● | | |
| | 6 | (Detection) 10 seconds continuous, ATT Relief Setting EPPR 2 drive current > 1.0 A (Cancellation) 3 seconds continuous, ATT Relief Setting EPPR 2 drive current ≤ 1.0 A | ● | | |
| (Results / Symptoms) 1. Control Function – Option attachment flow control – P2 relief pressure setting failure (Checking list) 1. CN-366 (#2) – CN-54 (#17) Checking Open/Short 2. CN-366 (#1) – CN-54 (#10) Checking Open/Short | | | | | |
| 301 | 3 | 10 seconds continuous, Fuel Level Measurement Voltage > 3.8V | ● | | |
| | 4 | 10 seconds continuous, Fuel Level Measurement Voltage < 0.3V | ● | | |
| | (Results / Symptoms) 1. Monitor – Fuel remaining display failure (Checking list) 1. CD-2 (#2) – CN-51 (#19) Checking Open/Short 2. CD-2 (#1) – CN-51 (#24) Checking Open/Short | | | | |
| 325 | 4 | (Model Parameter) mounting Fuel Warmer Relay (Detection) (When Fuel Warmer Relay is Off) 10 seconds continuous, Fuel Warmer Relay drive unit Measurement Voltage ≤ 3.0V (Cancellation) (When Fuel Warmer Relay is Off) 3 seconds continuous, Fuel Warmer Relay drive unit Measurement Voltage > 3.0V | ● | | |
| | 6 | (Detection) (When Fuel Warmer Relay is On) 10 seconds continuous, Fuel Warmer Relay drive current > 4.5 A (Cancellation) (When Fuel Warmer Relay is On) 3 seconds continuous, Fuel Warmer Relay drive current ≤ 4.5 A | ● | | |
| (Results / Symptoms) 1. Control Function – Fuel warmer operation failure (Checking list) 1. CR-46 (#85) – CN-52 (#13) Checking Open/Short 2. CR-46 (#86) – Fuse box (#23) Checking Open/Short | | | | | |

※ Some error codes are not applied to this machine.

G : General

C : Crawler Type

W : Wheel Type

| DTC | | Diagnostic Criteria | Application | | |
|--------------|--|---|-------------|---|---|
| HCESPN | FMI | | G | C | W |
| 501 (N.A) | 0 | 10 seconds continuous, Transmission Oil Press. Sensor Measurement Voltage > 5.2V | | | ● |
| | 1 | 10 seconds continuous, 0.3V ≤ Transmission Oil Press. Sensor Measurement Voltage < 0.8V | | | ● |
| | 4 | 10 seconds continuous, Transmission Oil Press. Sensor Measurement Voltage < 0.3V | | | ● |
| | (Results / Symptoms) 1. Monitor – Transmission Oil Press. display failure, Transmission Oil low pressure warning failure (Checking list) 1. CD-5 (#B) – CN-54 (#27) Checking Open/Short 2. CD-5 (#A) – CN-54 (#3) Checking Open/Short 3. CD-5 (#C) – CN-54 (#13) Checking Open/Short | | | | |
| 503 (N.A) | 0 | 10 seconds continuous, Brake Oil Press. Sensor Measurement Voltage > 5.2V | | | ● |
| | 1 | 10 seconds continuous, 0.3V ≤ Brake Oil Press. Sensor Measurement Voltage < 0.8V | | | ● |
| | 4 | 10 seconds continuous, Brake Oil Press. Sensor Measurement Voltage < 0.3V | | | ● |
| | (Results / Symptoms) 1. Monitor – Brake Oil Press. display failure, Brake Oil low pressure warning failure (Checking list) 1. CD-3 (#B) – CN-54 (#4) Checking Open/Short 2. CD-3 (#A) – CN-54 (#3) Checking Open/Short 3. CD-3 (#C) – CN-54 (#13) Checking Open/Short | | | | |
| 505 (N.A) | 0 | 10 seconds continuous, Working Brake Press. Sensor Measurement Voltage > 5.2V | | | ● |
| | 1 | 10 seconds continuous, 0.3V ≤ Working Brake Press. Sensor Measurement Voltage < 0.8V | | | ● |
| | 4 | 10 seconds continuous, Working Brake Press. Sensor Measurement Voltage < 0.3V | | | ● |
| | (Results / Symptoms) 1. Monitor – Working Brake Oil Press. display failure, Working Brake Oil low pressure warning failure (Checking list) 1. CD-38 (#B) – CN-54 (#5) Checking Open/Short 2. CD-38 (#A) – CN-54 (#3) Checking Open/Short 3. CD-38 (#C) – CN-54 (#13) Checking Open/Short | | | | |

※ Some error codes are not applied to this machine.

G : General

C : Crawler Type

W : Wheel Type

| DTC | | Diagnostic Criteria | Application | | |
|---|-----|---|-------------|---|---|
| HCESPN | FMI | | G | C | W |
| 514 (N.A) | 4 | (Detection) (When Parking Relay is Off) 10 seconds continuous, Parking Relay drive unit Measurement Voltage $\leq 3.0V$ (Cancellation) (When Parking Relay is Off) 3 seconds continuous, Parking Relay drive unit Measurement Voltage $> 3.0V$ | | | ● |
| | 6 | (Detection) (When Parking Relay is On) 10 seconds continuous, Parking Relay drive current $> 6.5 A$ (Cancellation) (When Parking Relay is On) 3 seconds continuous, Parking Relay drive current $\leq 6.5 A$ | | | ● |
| (Results / Symptoms) 1. Control Function – Parking Relay operation failure (Checking list) 1. CR-66 (#1) – CN-54 (#20) Checking Open/Short 2. CR-66 (#2) – CN-45 (#B+ term) Checking Open/Short | | | | | |
| 517 (N.A) | 4 | (Detection) (When Traveling Cutoff Relay is Off) 10 seconds continuous, Traveling Cutoff Relay drive unit Measurement Voltage $\leq 3.0V$ (Cancellation) (When Traveling Cutoff Relay is Off) 3 seconds continuous, Traveling Cutoff Relay drive unit Measurement Voltage $> 3.0V$ | | | ● |
| | 6 | (Detection) (When Traveling Cutoff Relay is On) 10 seconds continuous, Traveling Cutoff Relay drive current $> 6.5 A$ (Cancellation) (When Traveling Cutoff Relay is On) 3 seconds continuous, Traveling Cutoff Relay drive current $\leq 6.5 A$ | | | ● |
| (Results / Symptoms) 1. Control Function – Traveling Cutoff Relay operation failure (Checking list) 1. CR-47 (#85) – CN-54 (#9) Checking Open/Short 2. CR-47 (#86) – CN-45 (#B+ term) Checking Open/Short | | | | | |

※ Some error codes are not applied to this machine.

G : General

C : Crawler Type

W : Wheel Type

| DTC | | Diagnostic Criteria | Application | | |
|---|-----|---|-------------|---|---|
| HCESPN | FMI | | G | C | W |
| 525 (N.A) | 4 | (Detection) (When Ram Lock Solenoid is Off) 10 seconds continuous, Ram Lock Solenoid drive unit Measurement Voltage $\leq 3.0V$ (Cancellation) (When Ram Lock Solenoid is Off) 3 seconds continuous, Ram Lock Solenoid drive unit Measurement Voltage $> 3.0V$ | | | ● |
| | 6 | (Detection) (When Ram Lock Solenoid is On) 10 seconds continuous, Ram Lock Solenoid drive current $> 6.5 A$ (Cancellation) (When Ram Lock Solenoid is On) 3 seconds continuous, Ram Lock Solenoid drive current $\leq 6.5 A$ | | | ● |
| (Results / Symptoms) 1. Control Function – Ram lock control operation failure (Checking list) 1. CN-69 (#1) – CN-54 (#8) Checking Open/Short 2. CN-69 (#2) – CN-45 (#B+ term) Checking Open/Short | | | | | |
| 527 (N.A) | 4 | (Detection) (When Creep Solenoid is Off) 10 seconds continuous, Creep Solenoid drive unit Measurement Voltage $\leq 3.0V$ (Cancellation) (When Creep Solenoid is Off) 3 seconds continuous, Creep Solenoid drive unit Measurement Voltage $> 3.0V$ | | | ● |
| | 6 | (Detection) (When Creep Solenoid is On) 10 seconds continuous, Creep Solenoid drive current $> 6.5 A$ (Cancellation) (When Creep Solenoid is On) 3 seconds continuous, Creep Solenoid drive current $\leq 6.5 A$ | | | ● |
| (Results / Symptoms) 1. Control Function – Creep mode operation failure (Checking list) 1. CN-206 (#1) – CN-54 (#7) Checking Open/Short 2. CN-206 (#2) – CN-45 (#B+ term) Checking Open/Short | | | | | |

※ Some error codes are not applied to this machine.

G : General

C : Crawler Type

W : Wheel Type

| DTC | | Diagnostic Criteria | Application | | |
|--------------|---|--|-------------|---|---|
| HCESPN | FMI | | G | C | W |
| 530 (N.A) | 0 | 10 seconds continuous, Travel Forward Press. Sensor Measurement Voltage > 5.2V | | | ● |
| | 1 | 10 seconds continuous, 0.3V ≤ Travel Forward Press. Sensor Measurement Voltage < 0.8V | | | ● |
| | 4 | 10 seconds continuous, Travel Forward Press. Sensor Measurement Voltage < 0.3V | | | ● |
| | (Results / Symptoms) 1. Monitor – Travel Forward Press. display failure 2. Control Function – Driving interoperability power control operation failure (Checking list) 1. CD-73 (#B) – CN-54 (#6) Checking Open/Short 2. CD-73 (#A) – CN-54 (#3) Checking Open/Short 3. CD-73 (#C) – CN-54 (#13) Checking Open/Short | | | | |
| 531 (N.A) | 1 | 10 seconds continuous, 0.3V ≤ Travel Reverse Press. Sensor Measurement Voltage < 0.8V | | | ● |
| | 4 | 10 seconds continuous, Travel Reverse Press. Sensor Measurement Voltage < 0.3V | | | ● |
| | (Results / Symptoms) 1. Monitor – Travel Reverse Press. display failure 2. Control Function – Driving interoperability power control operation failure (Checking list) 1. CD-74 (#B) – CN-54 (#23) Checking Open/Short 2. CD-74 (#A) – CN-54 (#3) Checking Open/Short 3. CD-74 (#C) – CN-54 (#13) Checking Open/Short | | | | |
| | | | | | |
| 705 | 0 | 10 seconds continuous, Battery input Voltage > 35V | ● | | |
| | 1 | 10 seconds continuous, Battery input Voltage < 18V | ● | | |
| | (Results / Symptoms) 1. Control Function – Startup impossibility (Checking list) 1. CS-74A (#1) – CN-51 (#1) Checking Open/Short | | | | |
| 707 | 1 | (When Engine is equal or more than 400 rpm) 10 seconds continuous, Alternator Node D ⁺ Measurement Voltage < 18V (In case 12v goods, Alternator Node I Measurement Voltage < 9V) | ● | | |
| | (Results / Symptoms) 1. Control Function – Battery charging circuit failure (Checking list) 1. CS-74A (#1) – CN-51 (#26) Checking Open/Short | | | | |

※ Some error codes are not applied to this machine.

G : General

C : Crawler Type

W : Wheel Type

| DTC | | Diagnostic Criteria | Application | | |
|--------------|--|--|-------------|---|---|
| HCESPN | FMI | | G | C | W |
| 714 | 3 | (Model Parameter) Mounting Acc. Dial 10 seconds continuous, Acc. Dial Measurement Voltage > 5.2V | ● | | |
| | 4 | (Model Parameter) Mounting Acc. Dial 10 seconds continuous, Acc. Dial Measurement Voltage < 0.3V | ● | | |
| | (Results / Symptoms) 1. Monitor – Acc. Dial Voltage display failure 2. Control Function – Engine rpm control failure (Checking list) 1. CN-7 (#15) – CN-52 (#33) Checking Open/Short | | | | |
| 722 | 4 | (Detection) (When Travel Alarm (Buzzer) Sound is Off) 10 seconds continuous, Travel Alarm (Buzzer) Sound Relay drive unit Measurement Voltage ≤ 3.0V (Cancellation) (When Travel Alarm (Buzzer) Sound Relay is Off) 3 seconds continuous, Travel Alarm (Buzzer) Sound Relay drive unit Measurement Voltage > 3.0V | | ● | |
| | 6 | (Detection) (When Travel Alarm (Buzzer) Sound is On) 10 seconds continuous, Travel Alarm (Buzzer) Sound Relay drive current > 4.5 A (Cancellation) (When Travel Alarm (Buzzer) Sound is On) 3 seconds continuous, Travel Alarm (Buzzer) Sound Relay drive current ≤ 4.5 A | | ● | |
| | (Results / Symptoms) 1. Control Function – Driving alarm operation failure (Checking list) 1. CN-81 (#1) – CN-52 (#9) Checking Open/Short 2. CN-81 (#2) – Fuse box (#24) Checking Open/Short | | | | |
| 831 (N.A) | 2 | (When mounting the A/C Controller) 60 seconds continuous, A/C Controller Communication Data Error | ● | | |
| | (Results / Symptoms) 1. Control Function – A/C Controller operation failure (Checking list) 1. CN-11 (#8) – CN-51 (#22) Checking Open/Short 2. CN-11 (#7) – CN-51 (#32) Checking Open/Short | | | | |
| 840 | 2 | 60 seconds continuous, Cluster Communication Data Error | ● | | |
| | (Results / Symptoms) 1. Control Function – Cluster operation failure (Checking list) 1. CN-56A (#5) – CN-52 (#1) Checking Open/Short 2. CN-56A (#4) – CN-52 (#2) Checking Open/Short | | | | |

※ Some error codes are not applied to this machine.

G : General

C : Crawler Type

W : Wheel Type

| DTC | | Diagnostic Criteria | Application | | |
|--------------|---|--|-------------|---|---|
| HCESPN | FMI | | G | C | W |
| 841 | 2 | 10 seconds continuous, ECM Communication Data Error | ● | | |
| | (Results / Symptoms) 1. Control Function – ECM operation failure (Checking list) 1. CN-93 (#22) – CN-52 (#2) Checking Open/Short 2. CN-93 (#46) – CN-52 (#1) Checking Open/Short | | | | |
| 845 (N.A) | 2 | (When mounting the I/O Controller 1) 60 seconds continuous, I/O Controller 1 Communication Data Error | ● | | |
| | (Results / Symptoms) 1. Control Function – I/O Controller 1 operation failure (Checking list) 1. CN-53 (#21) – CN-51 (#23) Checking Open/Short 2. CN-53 (#31) – CN-51 (#33) Checking Open/Short | | | | |
| 848 (N.A) | 2 | (When mounting the Haptic Controller) 60 seconds continuous, Haptic Controller Communication Data Error | ● | | |
| | (Results / Symptoms) 1. Control Function – Haptic Controller operation failure (Checking list) 1. CN-8 (#2) – CN-51 (#22) Checking Open/Short 2. CN-8 (#3) – CN-51 (#32) Checking Open/Short | | | | |
| 850 | 2 | (When mounting the RMCU) 60 seconds continuous, RMCU communication Data Error | ● | | |
| | (Results / Symptoms) 1. Control Function – RMCU operation failure (Checking list) 1. CN-125A (#3) – CN-51 (#9) Checking Open/Short 2. CN-125A (#11) – CN-51 (#8) Checking Open/Short | | | | |
| 861 (N.A) | 2 | (When mounting the I/O Controller 2) 60 seconds continuous, I/O Controller 2 communication Data Error | ● | | |
| | (Results / Symptoms) 1. Control Function – I/O Controller 2 operation failure (Checking list) 1. CN-54 (#21) – CN-51 (#23) Checking Open/Short 2. CN-54 (#31) – CN-51 (#33) Checking Open/Short | | | | |

※ Some error codes are not applied to this machine.

G : General

C : Crawler Type

W : Wheel Type

| DTC | | Diagnostic Criteria | Application | | |
|--------------|--|--|-------------|---|---|
| HCESPN | FMI | | G | C | W |
| 866 | 2 | (When mounting the AAVM) 60 seconds continuous, AAVM communication Data Error | ● | | |
| | (Results / Symptoms) 1. Control Function – AAVM operation failure (Checking list) 1. CN-401 (#15) – CN-51 (#9) Checking Open/Short 2. CN-401 (#3) – CN-51 (#8) Checking Open/Short | | | | |
| 867 | 2 | 60 seconds continuous, RDU communication Data Error | ● | | |
| | (Results / Symptoms) 1. Control Function – RDU operation failure (Checking list) 1. CN-376 (#10) – CN-51 (#9) Checking Open/Short 2. CN-376 (#18) – CN-51 (#8) Checking Open/Short | | | | |
| 868 | 2 | 60 seconds continuous, Switch Controller communication Data Error | ● | | |
| | (Results / Symptoms) 1. Control Function – Switch Controller operation failure (Checking list) 1. CN-56A (#7) – CN-51 (#9) Checking Open/Short 2. CN-56A (#6) – CN-51 (#8) Checking Open/Short | | | | |
| 869 (N.A) | 2 | (When mounting the BKCU) 60 seconds continuous, BKCU communication Data Error | ● | | |
| | (Results / Symptoms) 1. Control Function – BKCU operation failure (Checking list) 1. CS-2B (#A) – CN-51 (#22) Checking Open/Short 2. CS-2B (#B) – CN-51 (#32) Checking Open/Short | | | | |

※ Some error codes are not applied to this machine.

G : General

C : Crawler Type

W : Wheel Type

4. ENGINE FAULT CODE

| Fault code J1939 SPN J1939 FMI | Item | Description |
|--------------------------------------|--|---|
| 111 629 12 | Engine control module critical internal failure | Bad intelligent device or component |
| 122 102 3 | Intake manifold 1 pressure sensor circuit | Voltage above normal, or shorted to high source |
| 123 102 4 | Intake manifold 1 pressure sensor circuit | Voltage below normal, or shorted to low source |
| 124 102 16 | Intake manifold 1 pressure | Data valid but above normal operating range - moderately severe level |
| 125 102 18 | Intake manifold 1 pressure | Data valid but below normal operating range - moderately severe level |
| 133 974 3 | Remote accelerator pedal or lever position sensor 1 circuit | Voltage above normal, or shorted to high source |
| 134 974 4 | Remote accelerator pedal or lever position sensor 1 circuit | Voltage below normal, or shorted to low source |
| 135 100 3 | Engine oil rifle pressure 1 sensor circuit | Voltage above normal, or shorted to high source |
| 141 100 4 | Engine oil rifle pressure 1 sensor circuit | Voltage below normal, or shorted to low source |
| 143 100 18 | Engine oil rifle pressure | Data valid but below normal operating range - moderately severe level |
| 144 110 3 | Engine coolant temperature 1 sensor circuit | Voltage above normal, or shorted to high source |
| 145 110 4 | Engine coolant temperature 1 sensor circuit | Voltage below normal, or shorted to low source |
| 146 110 16 | Engine coolant temperature | Data valid but above normal operating range - moderately severe level |
| 147 91 1 | Accelerator pedal or lever position 1 sensor circuit frequency | Data valid but below normal operating range |
| 148 91 0 | Accelerator pedal or lever position sensor 1 | Data valid but above normal operational range - most severe level |
| 151 110 0 | Engine coolant temperature | Data valid but above normal operational range - most severe level |

※ Some fault codes are not applied to this machine.

| Fault code J1939 SPN J1939 FMI | Item | Description |
|--------------------------------------|---|---|
| 153 105 3 | Intake manifold 1 temperature sensor circuit | Voltage above normal, or shorted to high source |
| 154 105 4 | Intake manifold 1 temperature sensor circuit | Voltage below normal, or shorted to low source |
| 187 3510 4 | Sensor supply 2 circuit | Voltage below normal, or shorted to low source |
| 197 111 18 | Coolant level | Data valid but below normal operating range - moderately severe level |
| 227 3510 3 | Sensor supply 2 circuit | Voltage above normal, or shorted to high source |
| 234 190 0 | Engine crankshaft speed/position | Data valid but above normal operational range - most severe level |
| 235 111 1 | Coolant level | Data valid but below normal operational range - most severe level |
| 237 644 2 | External speed command input (Multiple unit synchronization) | Data erratic, intermittent or incorrect |
| 238 3511 4 | Sensor supply 3 circuit | Voltage below normal, or shorted to low source |
| 239 3511 3 | Sensor supply 3 circuit | Voltage above normal, or shorted to high source |
| 241 84 2 | Wheel-based vehicle speed | Data erratic, intermittent or incorrect |
| 242 84 10 | Wheel-based vehicle speed sensor circuit tampering has been detected | Abnormal rate of change |
| 271 1347 4 | Engine fuel pump pressurizing assembly 1 circuit | Voltage below normal, or shorted to low source |
| 272 1347 3 | Engine fuel pump pressurizing assembly 1 circuit | Voltage above normal, or shorted to high source |
| 285 639 9 | SAE J1939 multiplexing pgn timeout error | Abnormal update rate |
| 286 639 13 | SAE J1939 multiplexing configuration error | Out of calibration |

※ Some fault codes are not applied to this machine.

| Fault code J1939 SPN J1939 FMI | Item | Description |
|--------------------------------------|---|---|
| 288 974 19 | SAE J1939 multiplexing remote accelerator pedal or lever position sensor system | Received network data in error |
| 293 441 3 | Auxiliary temperature sensor input 1 circuit | Voltage above normal, or shorted to high source |
| 294 441 4 | Auxiliary temperature sensor input 1 circuit | Voltage below normal, or shorted to low source |
| 297 1388 3 | Auxiliary pressure sensor input 2 circuit | Voltage above normal, or shorted to high source |
| 298 1388 4 | Auxiliary pressure sensor input 2 circuit | Voltage below normal, or shorted to low source |
| 322 651 5 | Injector solenoid driver cylinder 1 circuit | Current below normal or open circuit |
| 324 653 5 | Injector solenoid driver cylinder 3 circuit | Current below normal or open circuit |
| 331 652 5 | Injector solenoid driver cylinder 2 circuit | Current below normal or open circuit |
| 332 654 5 | Injector solenoid driver cylinder 4 circuit | Current below normal or open circuit |
| 334 110 2 | Engine coolant temperature | Data erratic, intermittent or incorrect |
| 343 629 12 | Engine control module warning internal hardware failure | Bad intelligent device or component |
| 349 191 16 | Transmission output shaft speed | Data valid but above normal operating range - moderately severe level |
| 351 3597 12 | Injector power supply | Bad intelligent device or component |
| 352 3509 4 | Sensor supply 1 circuit | Voltage below normal, or shorted to low source |
| 386 3509 3 | Sensor supply 1 circuit | Voltage above normal, or shorted to high source |
| 415 100 1 | Engine oil rifle pressure | Data valid but below normal operational range - most severe level |

※ Some fault codes are not applied to this machine.

| Fault code J1939 SPN J1939 FMI | Item | Description |
|--------------------------------------|--|--|
| 418 97 15 | Water in fuel indicator | Data valid but above normal operating range - least severe level |
| 428 97 3 | Water in fuel indicator sensor circuit | Voltage above normal, or shorted to high source |
| 429 97 4 | Water in fuel indicator sensor circuit | Voltage below normal, or shorted to low source |
| 431 558 2 | Accelerator pedal or lever idle validation switch | Data erratic, intermittent or incorrect |
| 432 558 13 | Accelerator pedal or lever idle validation switch circuit | Out of calibration |
| 435 100 2 | Engine oil rifle pressure | Data erratic, intermittent or incorrect |
| 451 157 3 | Injector metering rail 1 pressure sensor circuit | Voltage above normal, or shorted to high source |
| 452 157 4 | Injector metering rail 1 pressure sensor circuit | Voltage below normal, or shorted to low source |
| 488 105 16 | Intake manifold 1 temperature | Data valid but above normal operating range - moderately severe level |
| 489 191 18 | Transmission output shaft speed | Data valid but below normal operating range - moderately severe level |
| 497 1377 2 | Multiple unit synchronization switch | Data erratic, intermittent or incorrect |
| 515 3514 3 | Sensor supply 6 circuit | Voltage above normal, or shorted to high source |
| 516 3514 4 | Sensor supply 6 circuit | Voltage below normal, or shorted to low source |
| 527 702 3 | Auxiliary input/output 2 circuit | Voltage above normal, or shorted to high source |
| 529 703 3 | Auxiliary input/output 3 circuit | Voltage above normal, or shorted to high source |
| 553 157 16 | Injector metering rail 1 pressure | Data valid but above normal operating range - moderately severe level |

※ Some fault codes are not applied to this machine.

| Fault code J1939 SPN J1939 FMI | Item | Description |
|--------------------------------------|--|---|
| 559 157 18 | Injector metering rail 1 pressure | Data valid but below normal operating range - moderately severe level |
| 584 677 3 | Starter relay driver circuit | Voltage above normal, or shorted to high source |
| 585 677 4 | Starter relay driver circuit | Voltage below normal, or shorted to low source |
| 599 640 14 | Auxiliary commanded dual output shutdown | Special instructions |
| 611 1383 31 | Engine shut down hot | Condition exists |
| 649 1378 31 | Engine oil change interval | Condition exists |
| 687 103 18 | Turbocharger 1 speed | Data valid but below normal operating range - moderately severe level |
| 689 190 2 | Engine crankshaft speed/position | Data erratic, intermittent or incorrect |
| 691 1172 3 | Turbocharger 1 compressor intake temperature circuit | Voltage above normal, or shorted to high source |
| 692 1172 4 | Turbocharger 1 compressor intake temperature circuit | Voltage below normal, or shorted to low source |
| 693 1172 7 | Turbocharger 1 compressor intake temperature | Data erratic, intermittent or incorrect |
| 731 723 7 | Engine speed / position camshaft and crankshaft misalignment | Mechanical system not responding or out of adjustment |
| 741 1176 3 | Turbocharger 1 compressor intake pressure circuit | Voltage above normal, or shorted to high source |
| 742 1176 4 | Turbocharger 1 compressor intake pressure circuit | Voltage below normal, or shorted to low source |
| 743 1176 2 | Turbocharger 1 compressor intake pressure | Data erratic, intermittent or incorrect |

※ Some fault codes are not applied to this machine.

| Fault code J1939 SPN J1939 FMI | Item | Description |
|--------------------------------------|---|---|
| 769 597 3 | Brake switch circuit | Voltage above normal, or shorted to high source |
| 771 597 4 | Brake switch circuit | Voltage below normal, or shorted to low source |
| 778 723 2 | Engine camshaft speed / position sensor | Data erratic, intermittent or incorrect |
| 1117 3597 2 | Power supply lost with ignition on | Data erratic, intermittent or incorrect |
| 1239 2623 3 | Accelerator pedal or lever position sensor 2 circuit | Voltage above normal, or shorted to high source |
| 1241 2623 4 | Accelerator pedal or lever position sensor 2 circuit | Voltage below normal, or shorted to low source |
| 1242 91 2 | Accelerator pedal or lever position sensor 1 | Data erratic, intermittent or incorrect |
| 1358 91 3 | Accelerator pedal or lever position sensor 1 circuit | Voltage above normal, or shorted to high source |
| 1359 91 4 | Accelerator pedal or lever position sensor 1 circuit | Voltage below normal, or shorted to low source |
| 1515 91 19 | SAE J1939 multiplexed accelerator pedal or lever sensor system | Received network data in error |
| 1539 1387 3 | Auxiliary pressure sensor input 1 circuit | Voltage above normal, or shorted to high source |
| 1621 1387 4 | Auxiliary pressure sensor input 1 circuit | Voltage below normal, or shorted to low source |
| 1668 1761 4 | Aftertreatment 1 diesel exhaust fluid tank level sensor circuit | Voltage below normal, or shorted to low source |
| 1669 1761 3 | Aftertreatment 1 diesel exhaust fluid tank level sensor circuit | Voltage above normal, or shorted to high source |
| 1673 1761 1 | Aftertreatment 1 diesel exhaust fluid tank level | Data valid but below normal operational range -most severe level |
| 1677 3031 4 | Aftertreatment 1 diesel exhaust fluid tank temperature sensor | Voltage below normal, or shorted to low source |

※ Some fault codes are not applied to this machine.

| Fault code J1939 SPN J1939 FMI | Item | Description |
|--------------------------------------|---|---|
| 1678 3031 3 | Aftertreatment 1 diesel exhaust fluid tank temperature sensor | Voltage above normal, or shorted to high source |
| 1679 3031 2 | Aftertreatment 1 diesel exhaust fluid tank temperature | Data erratic, intermittent or incorrect |
| 1682 3362 31 | Aftertreatment 1 diesel exhaust fluid dosing unit input lines | Condition exists |
| 1685 3364 4 | Aftertreatment diesel exhaust fluid quality sensor circuit | Voltage below normal, or shorted to low source |
| 1686 3364 3 | Aftertreatment diesel exhaust fluid quality sensor circuit | Voltage above normal, or shorted to high source |
| 1695 3513 3 | Sensor supply 5 | Voltage above normal, or shorted to high source |
| 1696 3513 4 | Sensor supply 5 | Voltage below normal, or shorted to low source |
| 1713 3363 16 | Aftertreatment 1 diesel exhaust fluid tank heater | Data valid but above normal operating range - moderately severe level |
| 1714 3364 13 | Aftertreatment diesel exhaust fluid quality | Out of calibration |
| 1715 3364 11 | Aftertreatment diesel exhaust fluid quality | Root cause not known |
| 1843 101 3 | Crankcase pressure circuit | Voltage above normal, or shorted to high source |
| 1844 101 4 | Crankcase pressure circuit | Voltage below normal, or shorted to low source |
| 1852 97 16 | Water in fuel indicator | Data valid but above normal operating range - moderately severe level |
| 1879 3251 3 | Aftertreatment diesel particulate filter differential pressure sensor circuit | Voltage above normal |
| 1881 3251 4 | Aftertreatment diesel particulate filter differential pressure sensor circuit | Voltage below normal |
| 1883 3251 2 | Aftertreatment diesel particulate filter differential pressure sensor | Data erratic, intermittent or incorrect |

※ Some fault codes are not applied to this machine.

| Fault code J1939 SPN J1939 FMI | Item | Description |
|--------------------------------------|--|--|
| 1885 3216 4 | Aftertreatment 1 intake NOx sensor circuit | Voltage below normal, or shorted to low source |
| 1887 3226 4 | Aftertreatment 1 outlet NOx sensor circuit | Voltage below normal, or shorted to low source |
| 1921 3251 16 | Aftertreatment diesel particulate filter differential pressure | Data valid but above normal operating range |
| 1922 3251 0 | Aftertreatment diesel particulate filter differential pressure | Data valid but above normal operating range |
| 1993 4795 31 | Aftertreatment 1 diesel particulate filter missing | Condition exists |
| 2185 3512 3 | Sensor supply 4 circuit | Voltage above normal, or shorted to high source |
| 2186 3512 4 | Sensor supply 4 circuit | Voltage below normal, or shorted to low source |
| 2311 633 31 | Electronic fuel injection control valve circuit | Condition exists |
| 2321 190 2 | Engine crankshaft speed/position | Data erratic, intermittent or incorrect |
| 2322 723 2 | Engine camshaft speed / position sensor | Data erratic, intermittent or incorrect |
| 2373 1209 3 | Exhaust gas pressure sensor 1 circuit | Voltage above normal, or shorted to high source |
| 2374 1209 4 | Exhaust gas pressure sensor 1 circuit | Voltage below normal, or shorted to low source |
| 2448 111 17 | Coolant level | Data valid but below normal operating range - least severe level |
| 2468 190 16 | Engine speed | Engine crankshaft speed/position - data valid but above normal operating range - moderately severe level |
| 2554 1209 2 | Exhaust gas pressure 1 | Data erratic, intermittent or incorrect |
| 2557 697 3 | Auxiliary PWM driver 1 circuit | Voltage above normal, or shorted to high source |

※ Some fault codes are not applied to this machine.

| Fault code J1939 SPN J1939 FMI | Item | Description |
|--------------------------------------|---|---|
| 2558 697 4 | AuxiliaryPWM driver 1 circuit | Voltage below normal, or shorted to low source |
| 2571 2630 3 | Engine charge air cooler outlet temperature | Voltage above normal, or shorted to high source |
| 2572 2630 4 | Engine charge air cooler outlet temperature | Voltage below normal, or shorted to low source |
| 2639 3251 15 | Aftertreatment diesel particulate filter differential pressure | Data valid but above normal operating range |
| 2765 1209 16 | Engine injector group 1 | Engine injector bank 1 barcodes - out of calibration |
| 2771 3226 9 | Aftertreatment 1 outlet NOx sensor | Abnormal update rate |
| 2778 3481 16 | Aftertreatment fuel rate | Data valid but above normal operating range - moderately severe level |
| 2973 102 2 | Intake manifold 1 pressure | Data erratic, intermittent or incorrect |
| 2976 3361 2 | Aftertreatment 1 diesel exhaust fluid dosing unit temperature | Data erratic, intermittent or incorrect |
| 3133 3610 3 | Aftertreatment 1 diesel particulate filter outlet pressure sensor circuit | Voltage above normal, or shorted to high source |
| 3134 3610 4 | Aftertreatment 1 diesel particulate filter outlet pressure sensor circuit | Voltage below normal, or shorted to low source |
| 3135 3610 2 | Aftertreatment 1 diesel particulate filter outlet pressure | Data erratic, intermittent or incorrect |
| 3139 3667 3 | Engine air shutoff circuit | Voltage above normal, or shorted to high source |
| 3141 3667 4 | Engine air shutoff circuit | Voltage below normal, or shorted to low source |
| 3142 4360 3 | Aftertreatment 1 SCR intake temperature sensor circuit | Voltage above normal, or shorted to high source |
| 3144 4360 2 | Aftertreatment 1 SCR intake temperature sensor | Data erratic, intermittent or incorrect |

※ Some fault codes are not applied to this machine.

| Fault code J1939 SPN J1939 FMI | Item | Description |
|--------------------------------------|--|---|
| 3146 4363 3 | Aftertreatment 1 SCR outlet temperature sensor circuit | Voltage above normal, or shorted to high source |
| 3147 4363 4 | Aftertreatment 1 SCR outlet temperature sensor circuit | Voltage below normal, or shorted to low source |
| 3148 4363 2 | Aftertreatment 1 SCR outlet temperature sensor | Data erratic, intermittent or incorrect |
| 3151 4974 31 | Aftertreatment 1 SCR catalyst system missing | Condition exists |
| 3165 4363 0 | Aftertreatment 1 SCR outlet temperature | Data valid but above normal operational range - most severe |
| 3232 3216 9 | Aftertreatment 1 intake NOx sensor | Abnormal update rate |
| 3235 4363 16 | Aftertreatment 1 SCR outlet temperature | Data valid but above normal operating range - moderately severe level |
| 3251 4765 16 | Aftertreatment 1 diesel oxidation catalyst intake temperature | Data valid but above normal operating range |
| 3253 3242 16 | Aftertreatment 1 diesel particulate filter intake temperature | Data valid but above normal operating range |
| 3254 3242 16 | Aftertreatment 1 diesel particulate filter intake temperature | Data valid but above normal operating range |
| 3255 3246 16 | Aftertreatment 1 diesel particulate filter outlet temperature | Data valid but above normal operating range |
| 3311 3242 0 | Aftertreatment 1 diesel particulate filter intake temperature | Data valid but above normal operation |
| 3312 3246 0 | Aftertreatment 1 diesel particulate filter outlet temperature | Data valid but above normal operation |
| 3313 4765 4 | Aftertreatment 1 diesel oxidation catalyst intake temperature sensor circuit | Voltage below normal, or shorted to low source |
| 3314 4765 3 | Aftertreatment 1 diesel oxidation catalyst intake temperature sensor circuit | Voltage above normal, or shorted to high source |
| 3315 4765 2 | Aftertreatment 1 diesel oxidation catalyst intake temperature | Data erratic, intermittent or incorrect |

※ Some fault codes are not applied to this machine.

| Fault code J1939 SPN J1939 FMI | Item | Description |
|--------------------------------------|---|---|
| 3316 3242 4 | Aftertreatment 1 diesel particulate filter intake temperature sensor circuit | Voltage below normal, or shorted to low source |
| 3317 3242 3 | Aftertreatment 1 diesel particulate filter intake temperature sensor circuit | Voltage above normal, or shorted to high source |
| 3318 3242 2 | Aftertreatment 1 diesel particulate filter intake temperature | Data erratic, intermittent or incorrect |
| 3319 3246 3 | Aftertreatment 1 diesel particulate filter outlet temperature sensor circuit | Voltage above normal, or shorted to high source |
| 3321 3246 4 | Aftertreatment 1 diesel particulate filter outlet temperature sensor circuit | Voltage below normal, or shorted to low source |
| 3322 3246 2 | Aftertreatment 1 diesel particulate filter outlet temperature | Data erratic, intermittent or incorrect |
| 3326 91 9 | SAE J1939 multiplexed accelerator pedal or lever sensor system | Abnormal update rate |
| 3341 107 16 | Engine air filter differential pressure - data valid but above normal operating range | Moderately severe level |
| 3375 5397 31 | Aftertreatment diesel particulate filter regeneration too frequent | Condition exists |
| 3376 5319 31 | Aftertreatment diesel particulate filter incomplete regeneration | Condition exists |
| 3497 1761 17 | Aftertreatment 1 diesel exhaust fluid tank level | Data valid but below normal operating range - least severe level |
| 3498 1761 18 | Aftertreatment 1 diesel exhaust fluid tank level | Data valid but below normal operating range - moderately severe level |
| 3527 558 19 | Accelerator pedal or lever idle validation switch | Received network data in error |
| 3528 558 9 | Accelerator pedal or lever idle validation switch | Abnormal update rate |
| 3545 3226 31 | Aftertreatment 1 outlet NOx sensor | Abnormal rate of change |
| 3547 4096 31 | Aftertreatment diesel exhaust fluid tank empty | Condition exists |

※ Some fault codes are not applied to this machine.

| Fault code J1939 SPN J1939 FMI | Item | Description |
|--------------------------------------|---|---|
| 3558 3361 3 | Aftertreatment 1 diesel exhaust fluid dosing unit | Voltage above normal, or shorted to high source |
| 3559 3361 4 | Aftertreatment 1 diesel exhaust fluid dosing unit | Voltage below normal, or shorted to low source |
| 3567 5394 5 | Aftertreatment diesel exhaust fluid dosing valve | Current below normal or open circuit |
| 3568 5394 7 | Aftertreatment diesel exhaust fluid dosing valve | Mechanical system not responding or out of adjustment |
| 3571 4334 3 | Aftertreatment 1 diesel exhaust fluid pressure sensor | Voltage above normal, or shorted to high source |
| 3572 4334 4 | Aftertreatment 1 diesel exhaust fluid pressure sensor | Voltage below normal, or shorted to low source |
| 3574 4334 18 | Aftertreatment 1 diesel exhaust fluid pressure sensor | Data valid but below normal operating range |
| 3575 4334 16 | Aftertreatment 1 diesel exhaust fluid pressure sensor | Data valid but above normal operating range |
| 3577 4376 3 | Aftertreatment diesel exhaust fluid return valve | Voltage above normal, or shorted to high source |
| 3578 4376 4 | Aftertreatment diesel exhaust fluid return valve | Voltage above normal, or shorted to low source |
| 3583 5031 10 | Aftertreatment 1 outlet nox sensor heater | Abnormal rate of change |
| 3596 4334 2 | Aftertreatment 1 diesel exhaust fluid pressure sensor | Data erratic, intermittent or incorrect |
| 3641 748 9 | Transmission output retarder | Abnormal update rate |
| 3649 5024 10 | Aftertreatment 1 intake NOx sensor heater | Abnormal rate of change |
| 3681 3228 2 | Aftertreatment 1 outlet NOx sensor power supply | Data erratic, intermittent or incorrect |
| 3682 3218 2 | Aftertreatment 1 intake NOx sensor power supply | Data erratic, intermittent or incorrect |

※ Some fault codes are not applied to this machine.

| Fault code J1939 SPN J1939 FMI | Item | Description |
|--------------------------------------|--|---|
| 3697 630 12 | Engine control module calibration memory | Bad intelligent device or component |
| 3712 5246 0 | Aftertreatment SCR operator inducement | Data valid but above normal operational range - most severe level |
| 3714 1569 31 | Engine protection torque derate | Condition exists |
| 3725 3216 10 | Aftertreatment 1 intake NOx sensor | Abnormal rate of change |
| 3727 5571 7 | High pressure common rail fuel pressure relief valve | Mechanical system not responding or out of adjustment |
| 3737 1675 31 | Engine starter mode overcrank protection | Condition exists |
| 3741 5571 0 | High pressure common rail fuel pressure relief valve | Data valid but above normal operational range |
| 3748 3216 20 | Aftertreatment 1 intake NOx sensor | Data not rational - drifted high |
| 3765 442 3 | Auxiliary temperature sensor input 2 circuit | Voltage above normal, or shorted to high source |
| 3766 442 4 | Auxiliary temperature sensor input 2 circuit | Voltage below normal, or shorted to low source |
| 3838 2978 9 | Estimated engine parasitic losses - percent torque | Abnormal update rate |
| 3841 596 2 | Cruise control enable switch | Data erratic, intermittent or incorrect |
| 3843 5603 9 | Cruise control disable command | Abnormal update rate |
| 3845 5603 31 | Cruise control disable command | Condition exists |
| 3866 3364 1 | Aftertreatment diesel exhaust fluid quality | Data valid but below normal operational range - most severe level |
| 3868 3364 9 | Aftertreatment diesel exhaust fluid quality | Abnormal update rate |

※ Some fault codes are not applied to this machine.

| Fault code J1939 SPN J1939 FMI | Item | Description |
|--------------------------------------|--|---|
| 3878 3364 2 | Aftertreatment diesel exhaust fluid quality | Data erratic, intermittent or incorrect |
| 4151 5742 9 | Aftertreatment diesel particulate filter temperature sensor module | Abnormal update rate |
| 4152 5743 9 | Aftertreatment selective catalytic reduction temperature sensor module | Abnormal update rate |
| 4156 5746 4 | Aftertreatment 1 diesel exhaust fluid dosing unit heater relay | Voltage below normal, or shorted to low source |
| 4158 5742 12 | Aftertreatment diesel particulate filter temperature sensor module | Bad intelligent device or component |
| 4159 5743 12 | Aftertreatment selective catalytic reduction temperature sensor module | Bad intelligent device or component |
| 4161 5742 3 | Aftertreatment diesel particulate filter temperature sensor module | Voltage above normal, or shorted to high source |
| 4162 5742 4 | Aftertreatment diesel particulate filter temperature sensor module | Voltage below normal, or shorted to low source |
| 4163 5742 16 | Aftertreatment diesel particulate filter temperature sensor module | Data valid but above normal operating range |
| 4164 5743 3 | Aftertreatment selective catalytic reduction temperature sensor module | Voltage above normal, or shorted to high source |
| 4165 5743 4 | Aftertreatment selective catalytic reduction temperature sensor module | Voltage below normal, or shorted to low source |
| 4166 5743 16 | Aftertreatment selective catalytic reduction temperature sensor module | Data valid but above normal |
| 4168 5745 3 | Aftertreatment 1 diesel exhaust fluid dosing unit heater | Voltage above normal, or shorted to high source |
| 4169 5745 4 | Aftertreatment 1 diesel exhaust fluid dosing unit heater | Voltage below normal, or shorted to low source |
| 4249 4337 10 | Aftertreatment 1 diesel exhaust fluid dosing temperature | Abnormal rate of change |
| 4251 5798 10 | Aftertreatment 1 diesel exhaust fluid dosing unit heater temperature | Abnormal rate of change |

※ Some fault codes are not applied to this machine.

| Fault code J1939 SPN J1939 FMI | Item | Description |
|--------------------------------------|--|---|
| 4259 5742 11 | Aftertreatment diesel particulate filter temperature sensor module | Root cause not known |
| 4261 5743 11 | Aftertreatment selective catalytic reduction temperature sensor module | Root cause not known |
| 4277 3364 10 | Aftertreatment diesel exhaust fluid quality | Abnormal rate of change |
| 4284 5793 9 | Desired engine fueling state | Abnormal update rate |
| 4452 3226 7 | Aftertreatment 1 outlet NOx sensor closed loop operation | Condition exists |
| 4484 3667 7 | Engine air shutoff | Mechanical system not responding or out of Adjustment |
| 4526 521 2 | Brake pedal position | Data erratic, intermittent or incorrect |
| 4572 3031 9 | Aftertreatment 1 diesel exhaust fluid tank temperature | Abnormal update rate |
| 4584 3936 14 | Aftertreatment diesel particulate filter system | Special instructions |
| 4585 4792 14 | Aftertreatment 1 SCR catalyst system | Special instructions |
| 4677 1761 9 | SAE J1939 multiplexing pgn timeout error | Abnormal update rate |
| 4724 702 5 | Auxiliary input/output 2 circuit | Current below normal or open circuit |
| 4725 702 6 | Auxiliary input/output 2 circuit | Current above normal or grounded circuit |
| 4731 3031 13 | Aftertreatment 1 diesel exhaust fluid tank temperature sensor | Out of calibration |
| 4734 701 14 | Auxiliary input/output 1 | Special instructions |
| 4737 3031 11 | Aftertreatment 1 diesel exhaust fluid tank temperature | Root cause not known |

※ Some fault codes are not applied to this machine.

| Fault code J1939 SPN J1939 FMI | Item | Description |
|--------------------------------------|--|---|
| 4739 1761 11 | Aftertreatment 1 diesel exhaust fluid tank level sensor | Root cause not known |
| 4747 3217 20 | Aftertreatment intake oxygen sensor | Data not rational - drifted high |
| 4748 3217 21 | Aftertreatment intake oxygen sensor | Data not rational - drifted low |
| 4749 3227 20 | Aftertreatment outlet oxygen | Data not rational - drifted high |
| 4751 3227 21 | Aftertreatment outlet oxygen | Data not rational - drifted low |
| 4768 3521 11 | Aftertreatment 1 diesel exhaust fluid property | Root cause not known |
| 4769 1761 10 | Aftertreatment 1 diesel exhaust fluid tank level sensor | Abnormal rate of change |
| 4842 3364 15 | Aftertreatment diesel exhaust fluid quality | Data valid but above normal operating range - Least severe level |
| 4863 5245 31 | Aftertreatment diesel exhaust fluid tank low level indicator | - |
| 4953 3353 3 | Alternator 1 status | Voltage above normal, or shorted to high source |
| 4954 3353 4 | Alternator 1 status | Voltage below normal, or shorted to low source |
| 5248 1623 13 | Tachograph output shaft speed | Out of calibration |
| 5272 649 4 | Engine exhaust back pressure regulator control circuit | Voltage below normal, or shorted to low source |
| 5273 649 5 | Engine exhaust back pressure regulator control circuit | Current below normal or open circuit |
| 5274 5625 2 | Engine exhaust back pressure regulator position | Data erratic, intermittent or incorrect |
| 5275 5625 3 | Engine exhaust back pressure regulator position sensor circuit | Voltage above normal, or shorted to high source |

※ Some fault codes are not applied to this machine.

| Fault code J1939 SPN J1939 FMI | Item | Description |
|--------------------------------------|--|--|
| 5276 5625 4 | Engine exhaust back pressure regulator position sensor circuit | Voltage above normal, or shorted to low source |
| 5292 520809 31 | Excessive time since last engine air shutoff maintenance test | Condition exists |
| 5383 3720 15 | Aftertreatment 1 diesel particulate filter ash load percent | Data valid but above normal operating range - least severe level |
| 5576 107 15 | Engine air filter differential pressure | Data valid but above normal operating range - least severe level |
| 5632 6918 31 | SCR system cleaning inhibited due to inhibit switch | Condition exists |
| 5652 1209 15 | Exhaust pressure 1 | Data valid but above normal operating range - least severe level |
| 5653 6881 9 | SCR operator inducement override switch | Abnormal update rate |
| 5654 6881 13 | SCR operator inducement override switch | Out of calibration |
| 5655 4364 31 | Aftertreatment 1 scr conversion efficiency | Condition exists |
| 5689 3226 11 | Aftertreatment 1 outlet nox sensor | Root cause not known |
| 5715 3521 10 | Aftertreatment 1 diesel particulate filter differential pressure | Abnormal rate of change |
| 5716 3610 10 | Aftertreatment 1 diesel particulate filter outlet pressure | Abnormal rate of change |
| 5864 4375 3 | Aftertreatment 1 diesel exhaust fluid pump command circuit | Voltage above normal or shorted to high source |
| 5865 4375 4 | Aftertreatment 1 diesel exhaust fluid pump command circuit | Voltage below normal or shorted to low source |
| 5868 4339 7 | Aftertreatment 1 scr feedback control status | Mechanical system not responding or out of adjustment |
| 5935 4334 7 | Aftertreatment 1 diesel exhaust fluid pressure | Mechanical system not responding or out of adjustment |

※ Some fault codes are not applied to this machine.

| Fault code J1939 SPN J1939 FMI | Item | Description |
|--------------------------------------|---|--|
| 5936 4334 15 | Aftertreatment 1 diesel exhaust fluid pressure | Data valid but above normal operating range - least severe level |
| 5938 3750 14 | Aftertreatment 1 diesel particulate filter conditions not met for active regeneration | Special instructions |
| 5939 520968 9 | Machine constrained operation | Abnormal update rate. No communication or an Invalid data transfer rate has been detected on the J1939 data link between the ECM and the machine |
| 5941 520968 19 | Machine constrained operation | Received network data in error. The received J1939 datalink message was not valid. |
| 6256 168 15 | Battery 1 voltage | Data valid but below normal operating range - moderately severe level |
| 6257 168 17 | Battery 1 voltage | Data valid but below normal operating range - moderately severe level |
| 6263 647 3 | Fan control circuit | Voltage above normal, or shorted to high source |
| 6264 647 4 | Fan control circuit | Voltage below normal, or shorted to low source |
| 6456 5484 3 | Engine fan clutch 2 control circuit | Voltage above normal, or shorted to high source |
| 6457 5484 4 | Engine fan clutch 2 control circuit | Voltage below normal, or shorted to low source |
| 6467 1639 15 | Fan speed | Data valid but above normal operational range - most severe level |
| 6468 1639 17 | Fan speed | Data valid but below normal operational range - most severe level |
| 6471 6799 3 | Fan blade pitch position sensor circuit | Voltage above normal, or shorted to high source |
| 6472 6799 4 | Fan blade pitch position sensor circuit | Voltage below normal, or shorted to low source |
| 6475 3363 7 | Aftertreatment 1 diesel exhaust fluid tank heater | Mechanical system not responding or out of adjustment |
| 6476 3363 18 | Aftertreatment 1 diesel exhaust fluid tank heater | Data valid but below normal operating range - moderately severe level |

※ Some fault codes are not applied to this machine.

| Fault code J1939 SPN J1939 FMI | Item | Description |
|--------------------------------------|--|---|
| 6477 5491 3 | Aftertreatment diesel exhaust fluid line heater relay | Voltage above normal, or shorted to high source |
| 6478 5491 4 | Aftertreatment diesel exhaust fluid line heater relay | Voltage below normal, or shorted to low source |
| 6479 3363 3 | Aftertreatment 1 diesel exhaust fluid tank heater | Voltage above normal, or shorted to high source |
| 6481 3363 4 | Aftertreatment 1 diesel exhaust fluid tank heater | Voltage below normal, or shorted to low source |
| 6511 6655 3 | Maintain ECM power lamp | Voltage above normal, or shorted to high source |
| 6512 6655 4 | Maintain ECM power lamp | Voltage below normal, or shorted to low source |
| 6513 5745 17 | Aftertreatment 1 diesel exhaust fluid dosing unit heater | Data valid but below normal operating range |
| 6522 111 3 | Coolant level sensor 1 circuit | Voltage above normal, or shorted to high source |
| 6523 111 4 | Coolant level sensor 1 circuit | Voltage below normal, or shorted to low source |
| 6526 1761 13 | Aftertreatment 1 diesel exhaust fluid tank level sensor | Out of calibration |
| 6527 4376 7 | Aftertreatment diesel exhaust fluid return valve | Mechanical system not responding or out of adjust |
| 6529 5746 3 | Aftertreatment 1 diesel exhaust fluid dosing unit heater relay | Voltage above normal, or shorted to high source |
| 6531 4340 3 | Aftertreatment 1 diesel exhaust fluid line heater 1 circuit | Voltage above normal, or shorted to high source |
| 6532 4340 4 | Aftertreatment 1 diesel exhaust fluid line heater 1 circuit | Voltage below normal, or shorted to low source |
| 6533 4342 3 | Aftertreatment 1 diesel exhaust fluid line heater 2 circuit | Voltage above normal, or shorted to high source |
| 6534 4342 4 | Aftertreatment 1 diesel exhaust fluid line heater 2 circuit | Voltage below normal, or shorted to low source |

※ Some fault codes are not applied to this machine.

| Fault code J1939 SPN J1939 FMI | Item | Description |
|--------------------------------------|---|---|
| 6535 4344 3 | Aftertreatment diesel exhaust fluid line heater 3 circuit | Voltage above normal, or shorted to high source |
| 6536 4344 4 | Aftertreatment diesel exhaust fluid line heater 3 circuit | Voltage below normal, or shorted to low source |
| 6556 729 3 | Engine intake air heater 1 circuit | Voltage above normal, or shorted to high source |
| 6557 729 4 | Engine intake air heater 1 circuit | Voltage below normal, or shorted to low source |
| 6563 976 2 | Auxiliary intermediate (PTO) speed switch validation | Data erratic, intermittent or incorrect |
| 6568 3695 2 | Aftertreatment regeneration inhibit switch | Data erratic, intermittent or incorrect |
| 6583 441 14 | Auxiliary temperature sensor input 1 | Special instructions |
| 6584 1388 14 | Auxiliary pressure sensor input 2 | Special instructions |
| 6595 190 11 | Engine speed | Root cause not known |
| 6596 3713 31 | Diesel particulate filter active regeneration inhibited due to system timeout | Condition exists |
| 6599 521002 31 | Engine cranks slowly | Condition exists |
| 6611 6385 3 | Engine starter motor relay control circuit | Voltage above normal or shorted to high source |
| 6612 6385 4 | Engine starter motor relay control circuit | Voltage below normal or shorted to low source |
| 6613 5842 14 | SCR monitoring system malfunction | Special instructions |
| 6618 70 2 | Parking brake switch | Data erratic, intermittent, or incorrect |
| 6619 3515 10 | Aftertreatment 1 diesel exhaust fluid temperature 2 | Abnormal rate of change |

※ Some fault codes are not applied to this machine.

| Fault code J1939 SPN J1939 FMI | Item | Description |
|--------------------------------------|---|---|
| 6654 5626 7 | Engine exhaust back pressure regulator | Mechanical system not responding or out of adjustment |
| 6726 4796 31 | Aftertreatment 1 diesel oxidation catalyst missing | Condition exists |
| 6752 3364 18 | Aftertreatment diesel exhaust fluid quality | Data valid but below normal operating range - moderately severe level |
| 6771 521032 14 | Aftertreatment system assembly | Special instructions |
| 6938 5793 9 | Desired engine fueling state | Abnormal update rate |
| 6939 7745 9 | Engine start request | Abnormal update rate |
| 7133 7745 13 | Engine start request | Out of calibration |
| 7134 7746 13 | Engine start consent | Out of calibration |
| 7135 103 15 | Engine turbocharger speed | Data valid but above normal operating range - least severe level |
| 7745 1569 14 | Engine protection torque derate | Special instructions |
| 7393 7745 9 | Engine start request | Abnormal update rate |
| 7453 3242 15 | Aftertreatment 1 diesel particulate filter intake temperature | Data valid but above normal operating range - least severe level |
| 7454 3246 15 | Aftertreatment 1 diesel particulate filter outlet temperature | Data valid but above normal operating range - least severe level |

※ Some fault codes are not applied to this machine.

5. AAVM FAULT CODE

| Fault Code | Description |
|------------|--|
| A01 | AAVM Communication Error -AAVM |
| A02 | AAVM Communication Error -Front Camera |
| A03 | AAVM Communication Error -Rear Camera |
| A04 | AAVM Communication Error -Left Camera |
| A05 | AAVM Communication Error -Right Camera |
| A06 | Manual Setting Fail |
| A07 | No MCU CID |
| A08 | MCU CID Format Error |
| A09 | AAVM Hardware Error -AAVM |
| A10 | AAVM Hardware Error -Front Camera |
| A11 | AAVM Hardware Error -Rear Camera |
| A12 | AAVM Hardware Error -Left Camera |
| A13 | AAVM Hardware Error -Right Camera |
| A14 | MCU CID Model is not registered |
| A15 | MCU CID Model can't be applied |

GROUP 13 ENGINE CONTROL SYSTEM

1. MCU and ECM (Engine Control Module)

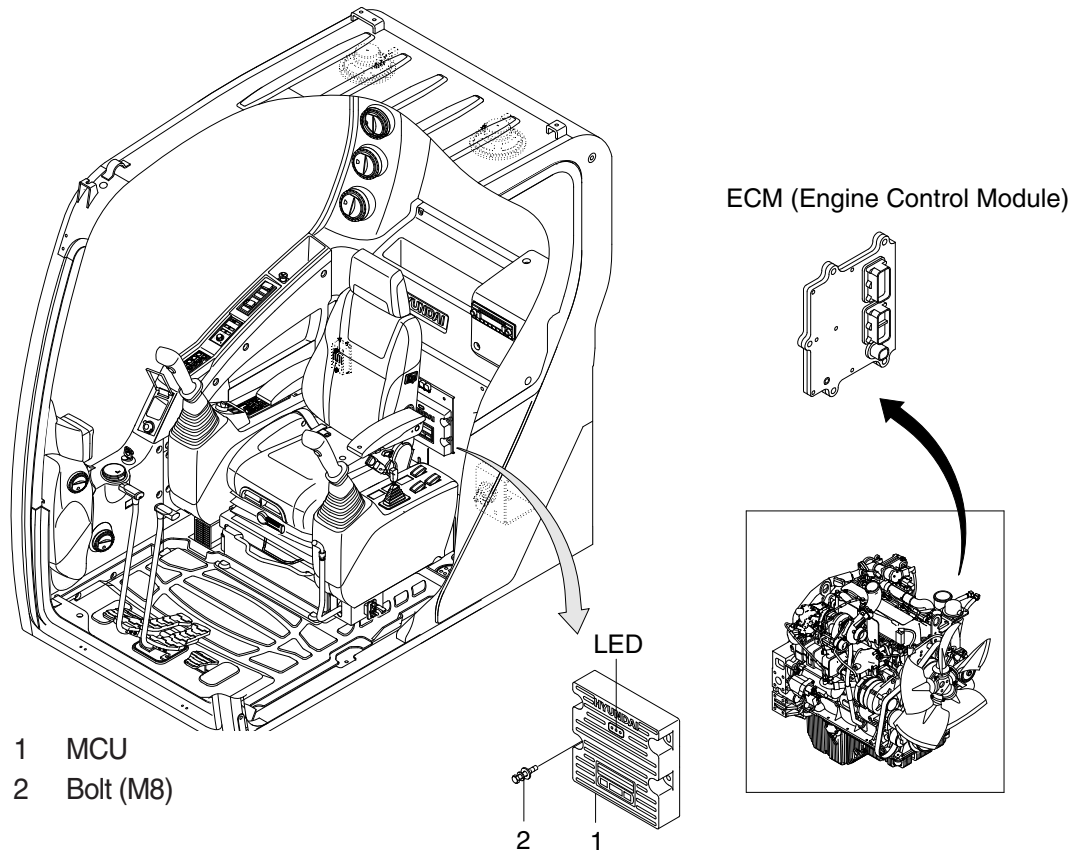

130A5MS30

2. MCU ASSEMBLY

1) To match the pump absorption torque with the engine torque, MCU varies EPPR valve output pressure, which control pump discharge amount whenever feedbacked engine speed drops under the reference rpm of each mode set.

2) Three LED lamps on the MCU display as below.

| LED lamp | Trouble | Service |
|--------------------------|--------------------------------------|--|
| G is turned ON | Normal | - |
| G and R are turned ON | Trouble on MCU | · Change the MCU |
| G and Y are turned ON | Trouble on serial communication line | · Check if serial communication lines between MCU and cluster are disconnected |
| Three LED are turned OFF | Trouble on MCU power | · Check if the input power wire (24 V, GND) of MCU is disconnected · Check the fuse |

G : green, R : red, Y : yellow

GROUP 14 EPPR VALVE

1. PUMP EPPR VALVE

1) COMPOSITION

EPPR (Electro Proportional Pressure Reducing) valve consists of electro magnet and spool valve installed at main pump.

(1) Electro magnet valve

Receive electric current from MCU and move the spool proportionally according to the specific amount of electric current value.

(2) Spool valve

Is the two way direction control valve for pilot pressure to reduce main pump flow.

When the electro magnet valve is activated, pilot pressure enters into flow regulator of main pump.

(3) Pressure and electric current value for each mode

| Mode | | Engine rpm | | Engine rpm (kgf/cm ²) | |
|----------|---|------------|------|-----------------------------------|------|
| | | No load | load | No load | load |
| Standard | P | 1900 | 1900 | 10 | 3 |
| | S | 1750 | 1850 | 12 | 5 |
| | E | 1650 | 1750 | 12 | 5 |
| Option | P | 1900 | 1900 | 8 | 3 |
| | S | 1850 | 1850 | 9 | 4 |
| | E | 1750 | 1750 | 10 | 5 |

2) HOW TO SWITCH THE POWER SHIFT (STANDARD ↔ OPTION) ON THE CLUSTER

You can switch the EPPR valve pressure set by selecting the power shift (standard ↔ option).

- Management
 - Service menu



Enter the password



- Power shift (standard/option) : Power shift pressure can be set by option menu.

3) OPERATING PRINCIPLE

(1) Structure

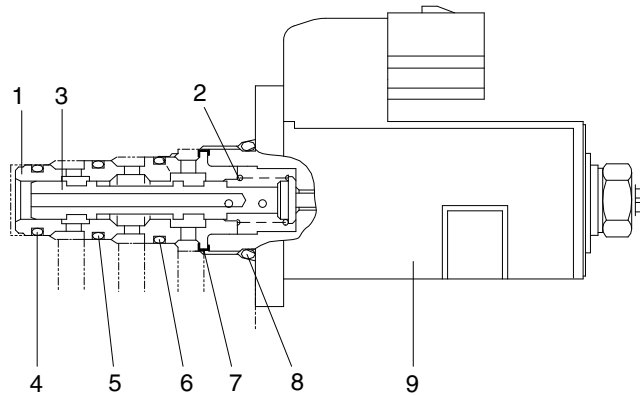

130A5MS31

- | | | |
|----------|----------|------------------|
| 1 Sleeve | 4 O-ring | 7 Retaining ring |
| 2 Spring | 5 O-ring | 8 O-ring |
| 3 Spool | 6 O-ring | 9 Solenoid valve |

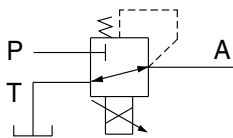

- P Pilot oil supply line (pilot pressure)
 T Return to tank
 A Secondary pressure to flow regulator at main pump

(2) Neutral

Pressure line is blocked and A oil returns to tank.

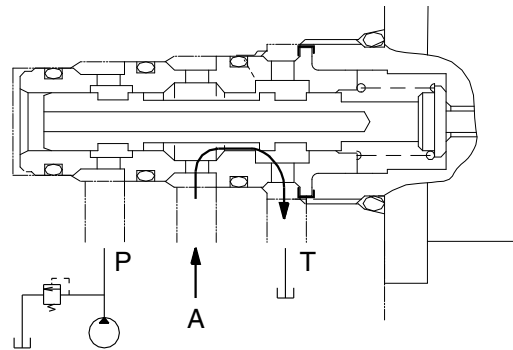
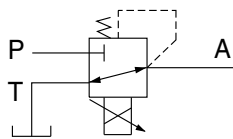

130A5MS32

(3) Operating

Secondary pressure enters into A.

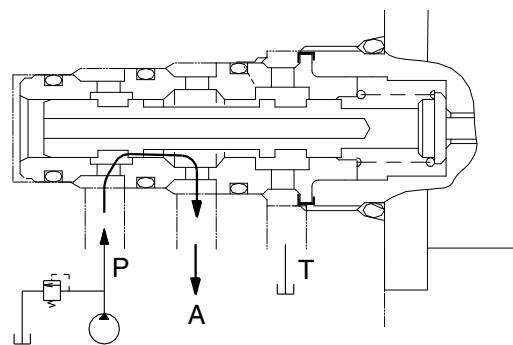
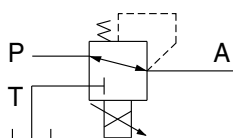

130A5MS33

4) EPPR VALVE CHECK PROCEDURE

(1) Check electric current value at EPPR valve

- ① Disconnect connector CN-75 from EPPR valve.
- ② Insert the adapter to CN-75 and install multimeter as figure.
- ③ Start engine.
- ④ Set S-mode and cancel auto decel mode.
- ⑤ Position the accel dial at 10.
- ⑥ If rpm display show approx 1750 ± 50 rpm check electric current at bucket circuit relief position.
- ⑦ Check electric current at bucket circuit relief position.

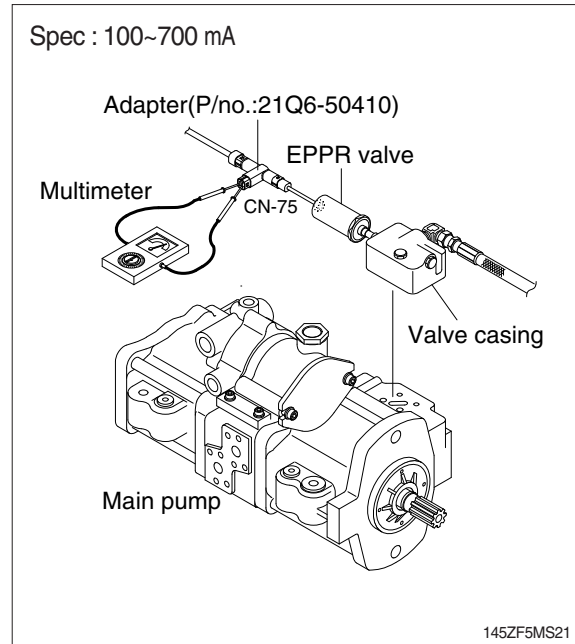

(2) Check pressure at EPPR valve

- ① Remove plug and connect pressure gauge as figure.
 - Gauge capacity : 0 to 50 kgf/cm²
(0 to 725 psi)
- ② Start engine.
- ③ Set S-mode and cancel auto decel mode.
- ④ Position the accel dial at 10.
- ⑤ Slowly operate control lever of bucket functions at full stroke over relief and measure the EPPR valve pressure by the the monitoring menu of the cluster.
- ⑥ If pressure is not correct, adjust it.
- ⑦ After adjust, test the machine.

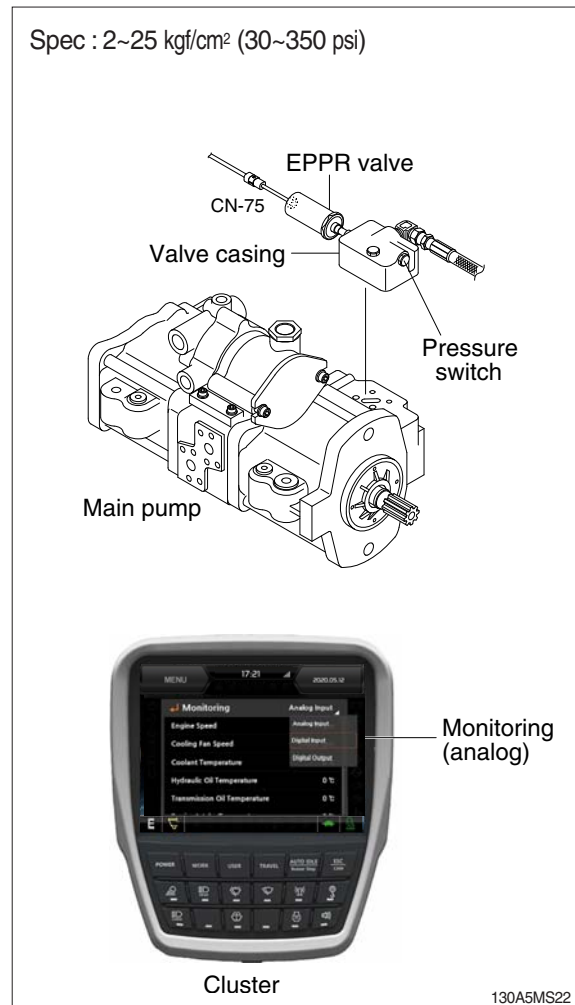

2. BOOM PRIORITY EPPR VALVE

1) COMPOSITION

The boom priority EPPR valve is built in a manifold and mainly consisting of valve body and coil. This EPPR valve installed under the solenoid valve.

2) CONTROL

The boom priority EPPR valve has to be controlled by a specific electronic amplifier card, which is supplying the coil with a current 580 mA at 30Ω and 24 V.

3) OPERATING PRINCIPLE

(1) Structure

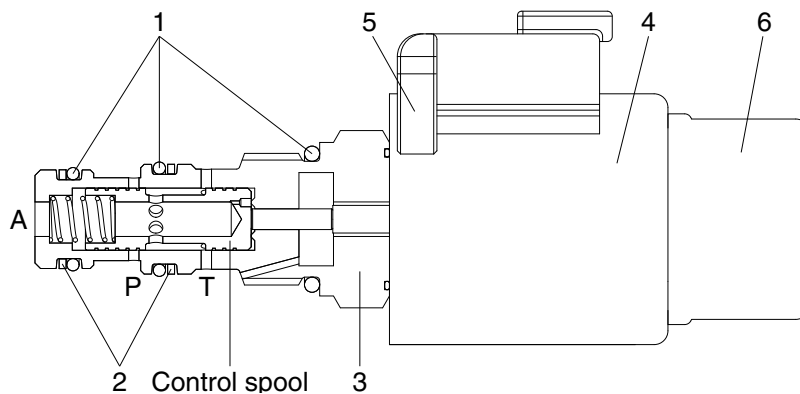

21095MS14

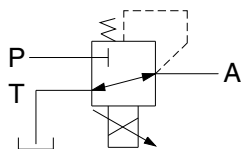

P : Pilot supply line
T : Return to tank
A : Secondary pressure to flow MCV

- | | | | | | |
|---|--------------|---|------------|---|-----------|
| 1 | O-ring | 3 | Valve body | 5 | Connector |
| 2 | Support ring | 4 | Coil | 6 | Cover cap |

(2) Operation

In de-energized mode the inlet port (P) is closed and the outlet port (A) is connected to tank port (T).

In energized mode the solenoid armature presses onto the control spool with a force corresponding to the amount of current. This will set a reduced pressure at port A. The setting is proportional to the amount of current applied.

(3) Maximum pressure relief

If a pressure from outside is applied on port A the valve may directly switch to tank port (T) and protect the system before overload.

2) EPPR VALVE CHECK PROCEDURE

(1) Check electric current value at EPPR valve

- ① Disconnect connector CN-133 from EPPR valve.
- ② Insert the adapter to CN-133 and install multimeter as figure.
- ③ Start engine.
- ④ Set S-mode and cancel auto decel mode.
- ⑤ If rpm display approx 1750 ± 50 rpm disconnect one wire harness from EPPR valve.
- ⑥ Check electric current in case of combined boom up and swing operation.

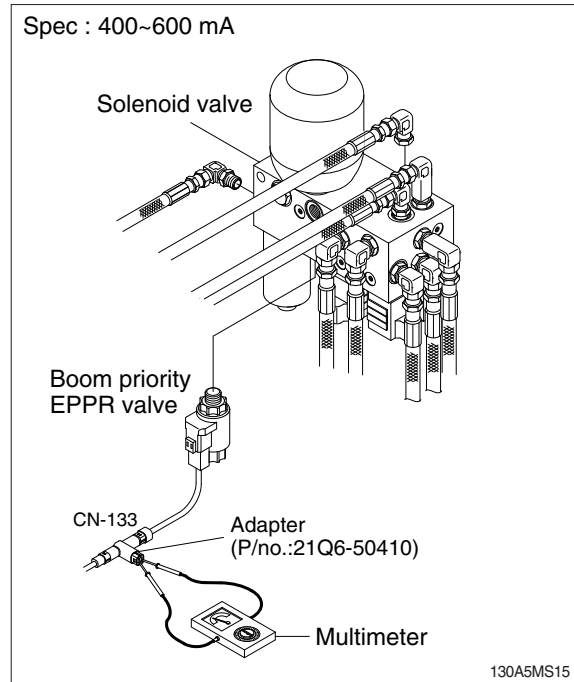

(2) Check pressure at EPPR valve

- ① Remove hose from A5 port and connect pressure gauge as figure.
 - Gauge capacity : 0 to 50 kgf/cm²
(0 to 725 psi)
- ② Start engine.
- ③ Set S-mode and cancel auto decel mode.
- ④ If rpm display approx 1750 ± 50 rpm check pressure (In case of combined boom up and swing operation).
- ⑤ If pressure is not correct, adjust it.
- ⑥ After adjust, test the machine.

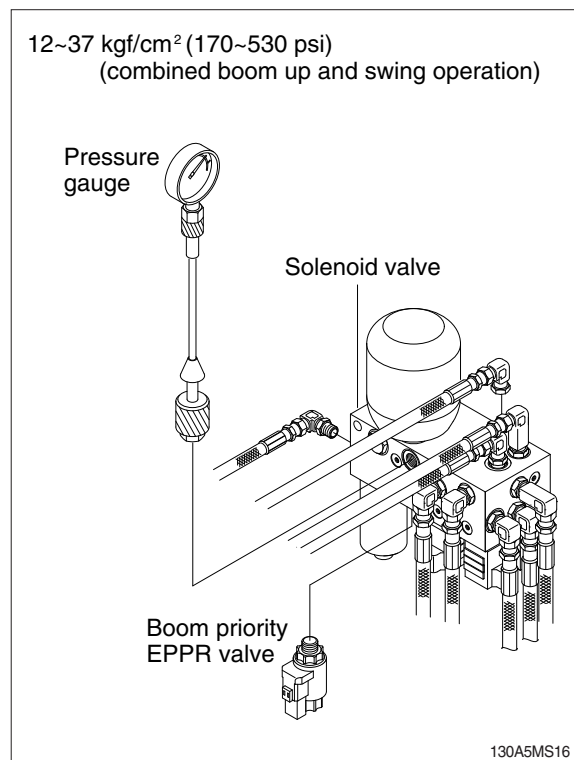

GROUP 15 MONITORING SYSTEM

1. STRUCTURE

The cluster consists of LCD and switches as shown below. The LCD is to warn the operator in case of abnormal machine operation or conditions for the appropriate operation and inspection.

Also, The LCD is to set and display for modes, monitoring and utilities with the switches.

The switches or touch screen are to set the machine operation modes.

- ※ The cluster installed on this machine does not entirely guarantee the condition of the machine. Daily inspection should be performed according to chapter 6, Maintenance.
- ※ When the cluster provides a warning immediately check the problem, and perform the required action.



130A5MS40

- ※ The warning lamp pops up and/or blinks and the buzzer sounds when the machine has a problem.

The warning lamp lights up or blinks until the problem is cleared. Refer to page 5-73 for details.

- ※ This cluster is adjustable.

- Vertical (forward/backward) : each 15°
- Horizontal (left only) : 8°

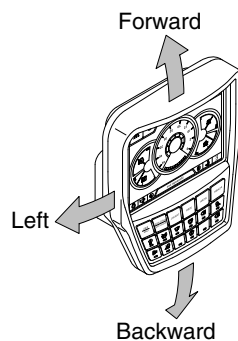

290F3CD47

2) CLUSTER CHECK PROCEDURE

(1) Start key : ON

① Check monitor

- a. Buzzer sounding for 4 seconds with HYUNDAI logo on cluster.
※ If the ESL mode is set to the enable, enter the password to start engine.

② After initialization of cluster, the operating screen is displayed on the LCD.

Also, self diagnostic function is carried out.

- a. Engine rpm display : 0 rpm
- b. Engine coolant temperature gauge : White range
- c. Hydraulic oil temperature gauge : White range
- d. Fuel level gauge : White range
- e. DEF/AdBlue® Level gauge : White range

③ Indicating lamp state

- a. Power mode pilot lamp : E mode or U mode
- b. Work mode pilot lamp : General operation mode (bucket)
- c. Travel speed pilot lamp : Low (turtle)

(2) Start of engine

① Check machine condition

- a. RPM display indicates at present rpm
- b. Gauge and warning lamp : Indicate at present condition.
※ When normal condition : All warning lamp OFF
- c. Work mode selection : General work
- d. Power mode selection : E mode or U mode
- e. Travel speed pilot lamp : Low (turtle)

② When warming up operation

- a. Warming up pilot lamp : ON
- b. After engine started, engine speed increases to 1200 rpm.
※ Others same as above.

③ When abnormal condition

- a. The warning lamp pops up and the buzzer sounds.
- b. If BUZZER STOP switch is pressed, buzzer sound is canceled but the warning lamp lights up or blinks until normal condition.
※ The pop-up warning lamp moves to the original position and warning lamp lights up or blinks when the buzzer stop switch is pushed. Also the buzzer stops.

3) CLUSTER CONNECTOR

(1) CN-56A

| No. | Name | Signal |
|-----|----------------|----------|
| 1 | Battery 24V | 20~32Vdc |
| 2 | Power IG (24V) | 20~32Vdc |
| 3 | GND | - |
| 4 | CAN 1 (H) | 0~5Vdc |
| 5 | CAN 1 (L) | 0~5Vdc |
| 6 | CAN 2 (H) | 0~5Vdc |
| 7 | CAN 2 (L) | 20~32Vdc |
| 8 | N.C. | - |
| 9 | N.C. | - |
| 10 | Aux left | 0~5Vdc |
| 11 | Aux right | 0~5Vdc |
| 12 | Aux GND | - |

(2) CN-56B

| No. | Name | Signal |
|-----|--------------|-------------|
| 1 | CAM 6.5V | 6.3~6.7Vdc |
| 2 | CAM GND | - |
| 3 | CAM DIFF (H) | 0~5Vdc |
| 4 | CAM DIFF (L) | 0~5Vdc |
| 5 | CAM 1 | NTSC signal |
| 6 | CAM 2 | NTSC signal |
| 7 | CAM 3 | NTSC signal |
| 8 | CAM shield | 0~5Vdc |

NTSC : National Television System Committee

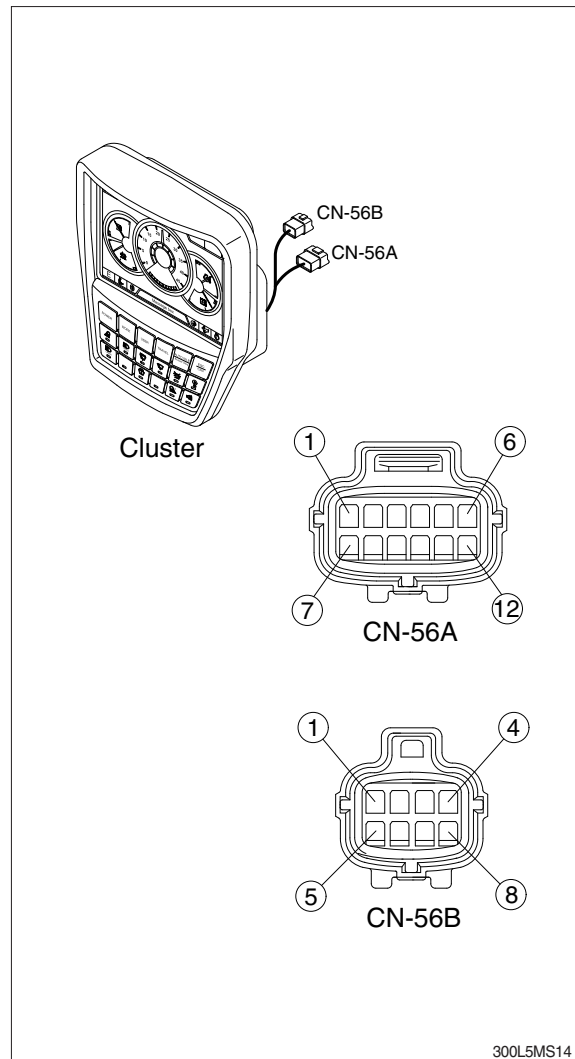

300L5MS14

4) GAUGE

(1) Operation screen

When you first turn starting switch ON, the operation screen will appear.



- | | | | |
|---|----------------------------------|---|-------------------|
| 1 | RPM / Speed gauge | 5 | Tripmeter display |
| 2 | Engine coolant temperature gauge | 6 | Eco gauge |
| 3 | Hydraulic oil temperature gauge | 7 | Accel dial gauge |
| 4 | Fuel level gauge | | |

130A3CD21

(2) RPM / Speed gauge





300A3CD22

- ① This displays the engine speed.

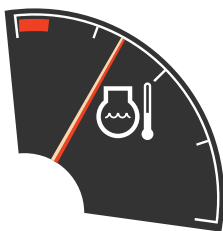
(3) Engine coolant temperature gauge





290F3CD53

- ① This gauge indicates the temperature of coolant.
- White range : 40-107°C (104-225°F)
 - Red range : Above 107°C (225°F)
- ② If the indicator is in the red range or  lamp pops up and the buzzer sounds, turn OFF the engine and check the engine cooling system.
- ※ If the gauge indicates the red range or  lamp blinks in red even though the machine is in the normal condition range, check the electric device as this can be caused by poor connection of sensor.

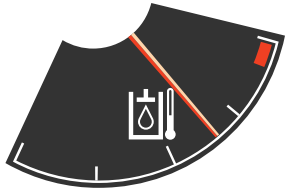
(4) Hydraulic oil temperature gauge





290F3CD54

- ① This gauge indicates the temperature of hydraulic oil.
 - White range : 40-105°C(104-221°F)
 - Red range : Above 105°C(221°F)
 - ② If the indicator is in the red range or  lamp pops up and the buzzer sounds reduce the load on the system. If the gauge stays in the red range, stop the machine and check the cause of the problem.
- ※ If the gauge indicates the red range or  lamp blinks in red even though the machine is in the normal condition range, check the electric device as this can be caused by poor connection of sensor.

(5) Fuel level gauge



130A3CD155

- ① This gauge indicates the amount of fuel in the fuel tank.
 - ② Fill the fuel when in the red range, or  lamp pops up and the buzzer sounds.
- ※ If the gauge indicates the red range or  lamp blinks in red even though the machine is in the normal condition range, check the electric device as this can be caused by poor connection of sensor.

(6) Tripmeter display

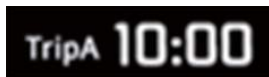

290F3CD56

- ① This displays the engine the tripmeter.
- ※ Refer to page 5-99 for details.

(7) Eco gauge



290F3CD58

- ① This gauge indicates the fuel consumption rate and machine load status so that the operators can operate the machine efficient in regards to fuel consumption.
- ② Fuel consumption rate or machine load is higher if the number of segments are increased.
- ③ The color of Eco gauge indicates operation status.
 - White : Idle operation
 - Green : Economy operation
 - Yellow : Non-economy operation at a medium level.
 - Red : Non-economy operation at a high level.

(8) Accel dial gauge



290F3CD59





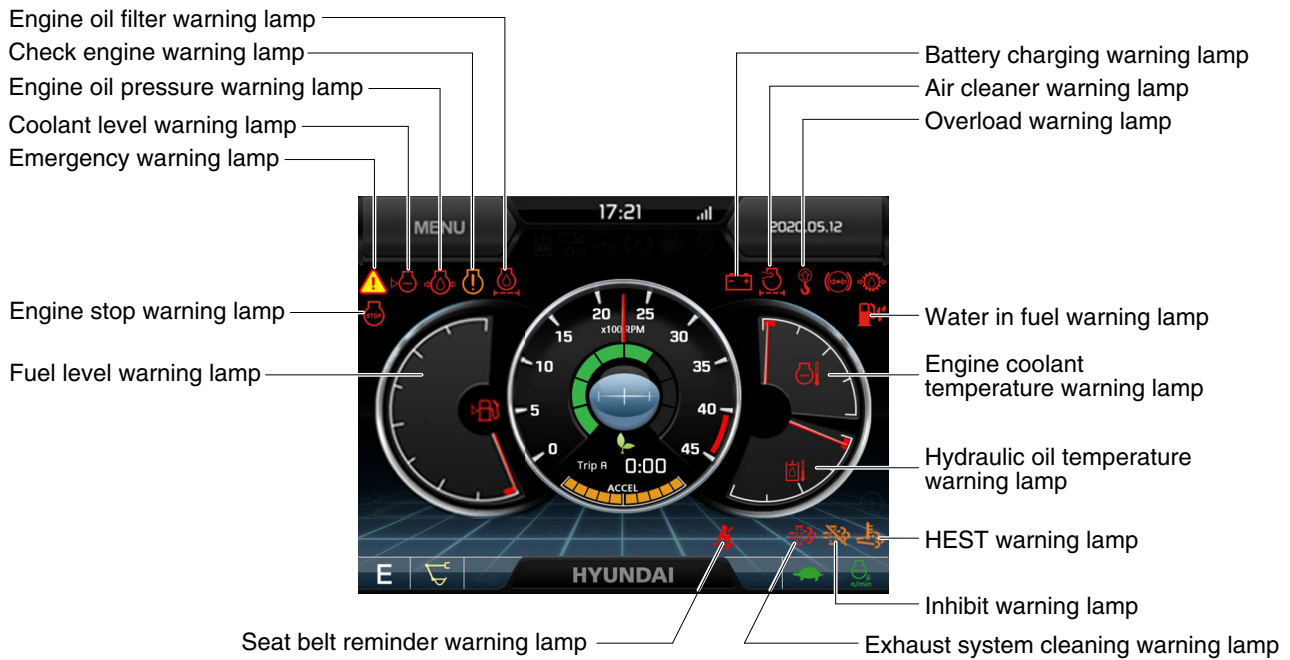

- ① This gauge indicates the level of accel dial.

5) WARNING LAMPS



130A3CD23A

※ Warning lamps and buzzer

| Warnings | When error happened | Lamps and buzzer |
|---|---|---|
| All warning lamps except below | Warning lamp pops up on the center of the LCD and the buzzer sounds | <ul style="list-style-type: none"> The pop-up warning lamp moves to the original position, blinks and the buzzer stops when; <ul style="list-style-type: none"> the buzzer stop switch  is pushed the lamp of the LCD is touched |
|  | Warning lamp pops up on the center of the LCD and the buzzer sounds | <ul style="list-style-type: none"> The pop-up warning lamp moves to the original position, lights up and the buzzer stops after 2 seconds elapses. |
|  | Warning lamp pops up on the center of the LCD and the buzzer sounds | <ul style="list-style-type: none"> The pop-up warning lamp moves to the original position, blinks and the buzzer stops after 2 seconds elapses. |
|  | Warning lamp pops up on the center of the LCD and the buzzer sounds | <ul style="list-style-type: none"> Cluster displays this pop-up when it has communication error with MCU. If communication with MCU become normal state, it will disappear automatically. |
|  | Warning lamp pops up on the center of the LCD and the buzzer sounds | ※ Refer to page 5-74 for details. |
|  | Warning lamp lights up and the buzzer sounds | ※ Refer to page 5-76 for details. |

※ Refer to the operator's manual page 3-14 for the buzzer stop switch  .

(5) Engine oil pressure warning lamp

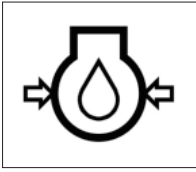

290F3CD65

- ① This warning lamp pops up and the buzzer sounds when the engine oil pressure is low.
- ② If the lamp lights up, shut OFF the engine immediately. Check oil level.

(6) Check engine warning lamp



290F3CD66

- ① This warning lamp pops up and the buzzer sounds when the communication between MCU and engine ECM is abnormal, or if the cluster received specific fault code from the engine ECM.
- ② Check the communication line between the two. If the communication line is OK, then check the fault codes on the cluster.

(7) Battery charging warning lamp

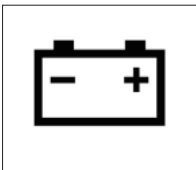

290F3CD67

- ① This warning lamp pops up and the buzzer sounds when the battery charging voltage is low.
- ② Check the battery charging circuit when this lamp blinks.

(8) Air cleaner warning lamp

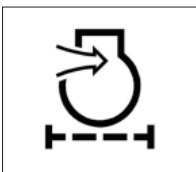

290F3CD68

- ① This warning lamp pops up and the buzzer sounds when the air cleaner is clogged.
- ② Check, clean or replace filter.

(9) Overload warning lamp (opt)



290F3CD69

- ① When the machine is overloaded, the overload warning lamp pops up and the buzzer sounds when the overload switch is ON. (if equipped)
- ② Reduce the machine load.

(10) Engine stop warning lamp



290F3CD252

- ① This lamp pops up and the buzzer sounds when the manual (stationary) exhaust system cleaning is not performed.
- ※ Refer to page 5-75-1.
- ※ Please contact your HD Hyundai Construction Equipment service center or local dealer.
- ※ "Engine shutdown" cluster message pops up when the exhaust gas temperature reaches above 800°C.

(11) Exhaust system cleaning warning lamp

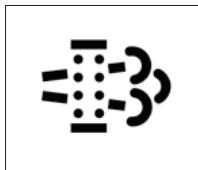

290F3CD70

- ① This warning lamp lights up or blinks when exhaust system cleaning is needed as seen in the table below.

| Warning lamp | | | | Description |
|--------------|------------|--------------|-------------|--|
| Exhaust | HEST | Check engine | Stop engine | |
| | | | | |
| Off | Off | Off | Off | · Normal operating mode |
| On (Amber) | Off | Off | Off | · Manual (stationary) exhaust system cleaning is recommended. ※ Refer to page 5-75-2. |
| On (Amber) | Off | On (Red) | Off | · Manual exhaust system cleaning must be conducted immediately. · Engine power will be reduced automatically if action is not taken. ※ Refer to page 5-75-2. |
| On (Amber) | Off | On (Red) | On (Red) | · These lamps will be ON if manual exhaust system cleaning is not conducted for a certain period of time. Stop the engine immediately. · Please contact HD Hyundai Construction Equipment service center or local dealer. |
| Blink (Red) | Off | Off | Off | · The exhaust system cleaning lamp will blink without HEST lamp while automatic exhaust system cleaning is being performed. · Low idle speed will increase to 1400 rpm. · The machine can be operated as normal operating mode. · Fuel consumption may slightly increase. |
| Blink (Red) | On (Amber) | Off | Off | · The exhaust system cleaning lamp will blink with HEST lamp while manual exhaust system cleaning is being performed. · The machine must remain stationary at low idle. ※ Refer to page 5-75-2. |

(12) Exhaust system cleaning inhibit warning lamp

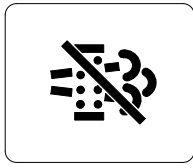

2609A3CD20

- ① This warning lamp indicates the exhaust system cleaning switch is pushed to the inhibit position, therefore automatic and manual exhaust system cleaning can not occur.
- ※ Refer to the operator's manual page 3-34-1 for the exhaust system cleaning switch.

※ Manual exhaust system cleaning



Safety button

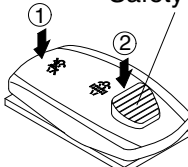

Exhaust warning lamp blink



HEST warning lamp ON

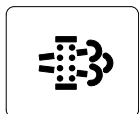

Exhaust warning lamp OFF



HEST warning lamp ON → OFF

235A3CD173A

- ※ Manual exhaust system cleaning must be operated in a fireproof area.
- ※ To stop a manual exhaust system cleaning before it has completed, set to the exhaust system cleaning switch to the inhibit position or turn OFF the engine.
- ① Stop and park the machine.

- ② Pull the safety button and push the switch to position ② to initiate the manual exhaust system cleaning.
- ※ Refer to the operator's manual page 3-34-1 for the exhaust system cleaning switch operation.
- ※ The engine speed may increase to 1400 rpm and exhaust system cleaning begins and it will take approximately 20~30 minutes.
- ③ The exhaust system cleaning warning lamp will blink and HEST warning lamp will light up during the exhaust system cleaning operation.
- ④ The exhaust system cleaning and/or HEST warning lamp light will go off when the exhaust system cleaning is completed.

(13) HEST (High exhaust system temperature) **warning lamp**

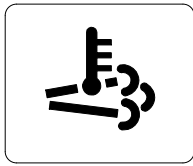

2609A3CD21

- ① This warning lamp indicates, when illuminated, that exhaust temperatures are high due to exhaust system cleaning.
- ② The lamp will also illuminate during a manual exhaust system cleaning.
- ③ When this lamp is illuminated, be sure the exhaust pipe outlet is not directed at any surface or material that can melt, burn, or explode.

▲ When this lamp is illuminated, the exhaust gas temperature could reach 800°C [1500°F], which is hot enough to ignite or melt common materials, and to burn people.

※ The lamp does not signify the need for any kind of equipment or engine service; It merely alerts the equipment operator to high exhaust temperatures. It is common for the lamp to illuminate on and off during normal equipment operation as the engine completes exhaust system cleaning cycles.

(14) Water in fuel warning lamp

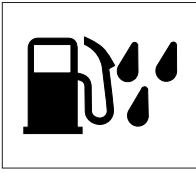

300A3CD24A

- ① This warning lamp lights up and the buzzer sounds when the water separator is full of water or malfunctioning.
- ※ **When this lamp lights up, stop the machine and drain water from the separator.**

(15) Seat belt reminder warning lamp



300A3CD25

- ① When operator does not fasten the operator's seat belt, the seat belt reminder warning lamp pops up and the buzzer sounds.
- ② Fasten the seat belt.

(16) Coolant level warning lamp

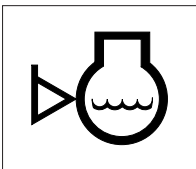

760F3CD58

- ① This warning lamp indicates lack of coolant.
- ② Check and refill coolant.

(17) Engine oil filter warning lamp

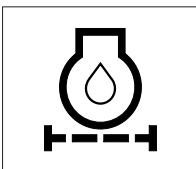

300A3CD306





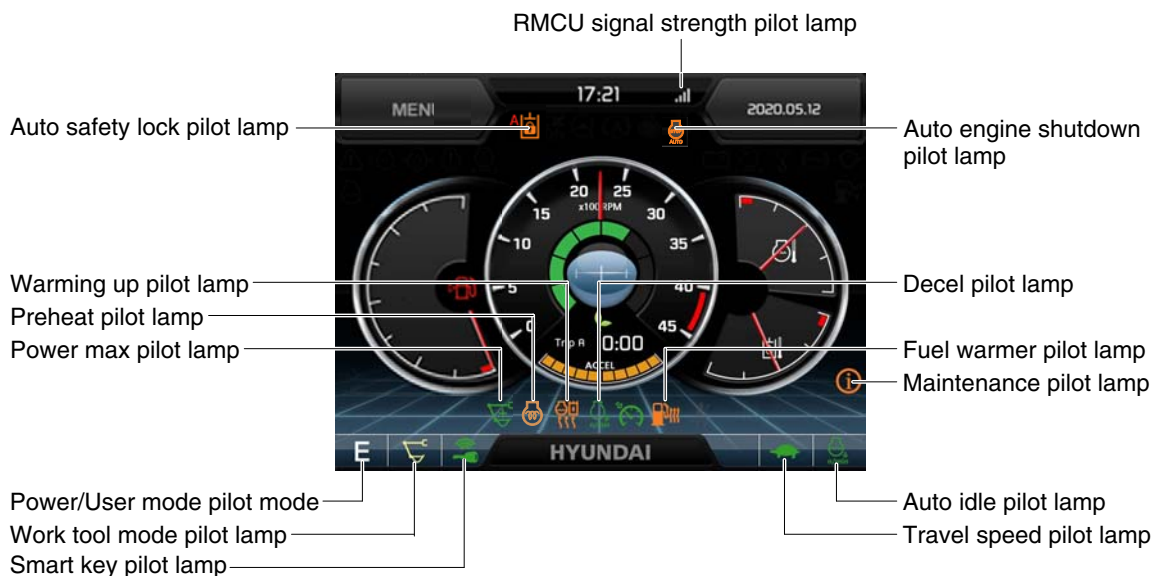







- ① This warning lamp pops up and the buzzer sounds when the engine oil filter is clogged.
- ② Check, clean or replace filter.

6) PILOT LAMPS



130A3CD26

(1) Mode pilot lamps

| No | Mode | Pilot lamp | Selected mode |
|----|----------------|---|---|
| 1 | Power mode |  | Heavy duty power work mode |
| | |  | Standard power mode |
| | |  | Economy power mode |
| 2 | User mode |  | User preferable power mode |
| 3 | Work tool mode |  | General operation - IPC speed mode |
| | |  | General operation - IPC balance mode |
| | |  | General operation - IPC efficiency mode |
| | |  | Breaker operation mode |
| | |  | Crusher operation mode |
| | |  | Lifting mode |
| 4 | Travel mode |  | Low speed traveling |
| | |  | High speed traveling |
| 5 | Auto idle mode |  | Auto idle |

(2) Power max pilot lamp



300A3CD32

- ① The lamp will be ON when pushing power max switch on the LH RCV lever.
 - ② The power max function operates for a max period of 8 seconds.
- ※ Refer to the operator's manual page 3-35 for power max function.

(3) Preheat pilot lamp

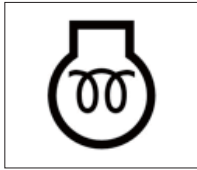

290F3CD79

- ① Turning the start key switch to the ON position starts preheating in cold weather.
- ② Start the engine after this lamp goes OFF.

(4) Warming up pilot lamp

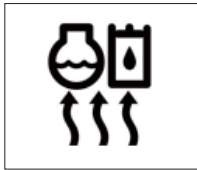

290F3CD80

- ① This lamp lights up when the coolant temperature is below 30°C (86°F).
- ② The automatic warming up is cancelled when the engine coolant temperature is above 30°C (86°F), or when 10 minutes have passed since starting the engine.

(5) Decel pilot lamp



300A3CD33

- ① Operating one touch decel switch on the RCV lever makes the lamp light up.
- ② Also, the lamp will light up and engine speed will be reduced automatically to save fuel when all levers and pedals are in the neutral position, and the auto idle function is selected.
- ③ If it follows the case below, decel goes off in the idle state.
 - Auto idle button off
 - Working/Travel
 - One touch decel button off
 - Safety lever unlock

※ Refer to the operator's manual page 3-35.

(6) Fuel warmer pilot lamp



300A3CD34

- ① This lamp lights up when the coolant temperature is below 10°C (50°F) or the hydraulic oil temperature is 20°C (68°F).
- ② The automatic fuel warming is cancelled when the engine coolant temperature is above 60°C (140°F), and the hydraulic oil temperature is above 45°C (113°F) since the start switch was ON position.

(7) Maintenance pilot lamp



300A3CD35

- ① This lamp lights up when consumable parts are in need of replacement. It means that the change or replacement interval of parts is 30 hours from the required change interval.
- ② Check the message in maintenance information of main menu. Also, this lamp lights up for 3 minutes when the start switch is switched to the ON position.



※ Refer to page 5-92.

(8) RMCU signal strength pilot lamp (mobile only)



220A3CD200

① This lamp indicates RMCU signal strength as below.

-  : Searching
-  : Bad
-  : Normal
-  : Good
-  : Excellent

(9) Smart key pilot lamp (opt)



300A3CD36A

① This lamp lights up when the engine is started by the start button.

② This lamp is red when the authentication fails, it will be green when authentication is successful.

※ Refer to the page 5-93.

(10) Auto safety lock pilot lamp



140WA3CD37

① Auto safety lock system prevents unintended operation of the machine in order to improve safety.

② Engine will only start if safety lever is locked.

③ If operator unlocks safety lever when RCV lever is pressed, machine is not controlled by RCV lever.

⚠ If operator unlocks safety lever while any control/function is being operated, the machine will move violently. This could cause serious injury, death or damage to property.

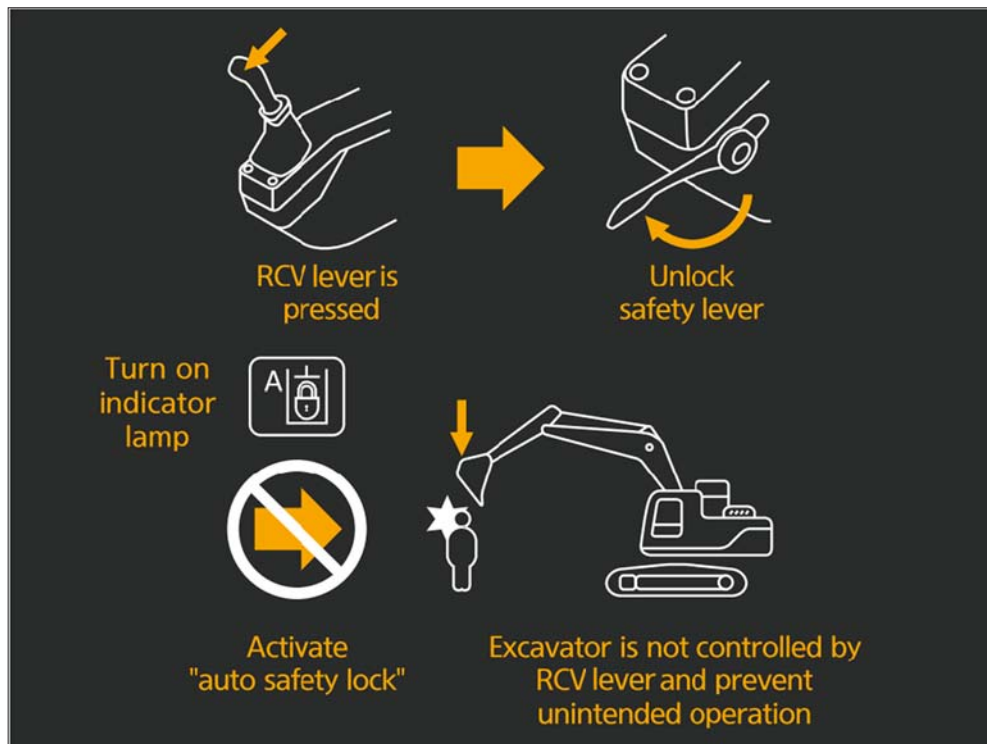

145A3CD38

(11) Auto engine shutdown pilot lamp



220A3CD202A

① This lamp lights up when the auto engine shutdown is activated.

※ Refer to page 5-88.

7) SWITCHES



130A3CD39

※ When some of the switches are selected, the pilot lamps are displayed on the LCD. Refer to page 5-77 for details.

(1) Power mode switch

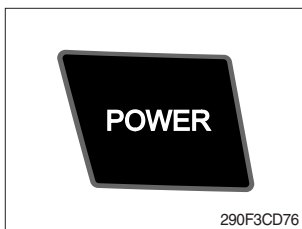

- This switch is to select the machine power mode and when pressed, the power mode pilot lamp will be displayed on the section of the monitor.
 - P : Heavy duty power work.
 - S : Standard power work.
 - E : Economy power work.
- The pilot lamp changes E → S → P → E in this order.

(2) Work mode switch

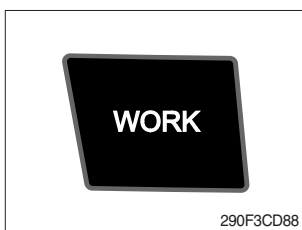

- This switch is to select the machine work mode, which shifts from general operation mode to optional attachment operation mode or lifting mode.
 - : General operation mode
 - : Breaker operation mode (if equipped)
 - : Crusher operation mode (if equipped)
 - : Lifting mode
 - Not installed : Breaker or crusher is not installed and lifting mode is not activated.

※ Refer to the operator's manual page 2-7 for details.

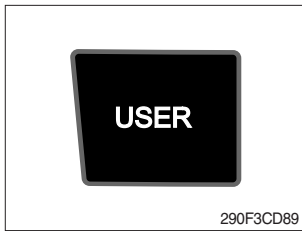

(3) User mode switch



- ① This switch is used to select the user mode.
- ② Refer to page 5-86 for another set of the user mode.

(4) Travel speed switch



- ① This switch is used to select the travel speed alternatively.
 -  : Low speed
 -  : High speed

※ Do not change the setting of the travel speed switch while machine is moving. Machine stability may be adversely affected.

▲ Serious injury or death can result from sudden changes in machine stability.

(5) Auto idle/ buzzer stop switch



- ① This switch is used to activate or cancel the auto idle function.
 - Pilot lamp ON : Auto idle function is activated.
 - Pilot lamp OFF : Auto idle function is cancelled.
- ② The buzzer sounds when the machine has a problem. In this case, push this switch and buzzer stops, but the warning lamp blinks until the problem is cleared.

(6) Escape/Camera switch

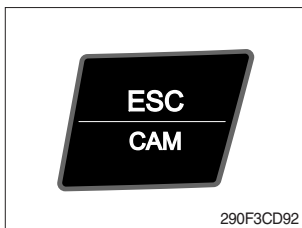

- ① This switch is used to return to the previous menu or parent menu.
- ② In the operation screen, pushing this switch will display the view of the camera on the machine (if equipped). Please refer to page 5-99 for the camera.
- ③ If the camera is not installed, this switch is used only ESC function.

(7) Work light switch

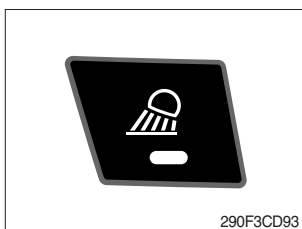

- ① This switch is used to operate the work light.
- ② The pilot lamp lights up when this switch is pressed.

(8) Head light switch



- ① This switch is used to operate the head light.
- ② The pilot lamp lights up when this switch is pressed.

(9) Intermittent wiper switch



- ① When this switch is pressed, wipers operate intermittently.
- ② The pilot lamp lights up when this switch is pressed.

(10) Wiper switch



- ① This switch is used to operate the wiper.
- ② Note that the wiper will self-park when switched off.
- ③ The pilot lamp lights up when this switch is pressed.
- △ **If the wiper does not operate with the switch in ON position, turn the switch OFF immediately. Check the cause. If the switch remains ON, motor failure can result.**

(11) Washer switch

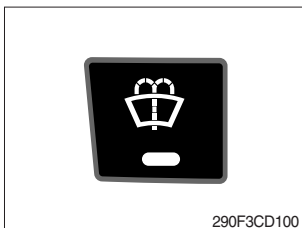

- ① Washer fluid is sprayed and the wiper is operated only when this switch is pressed.
- ② The pilot lamp lights up when this switch is pressed.

(12) Cab light switch

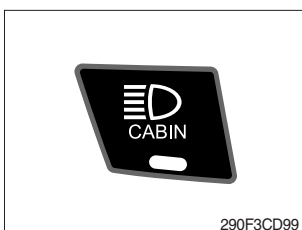

- ① This switch turns on the cab light.
- ② The pilot lamp lights up when this switch is pressed.

(13) Beacon switch (opt)

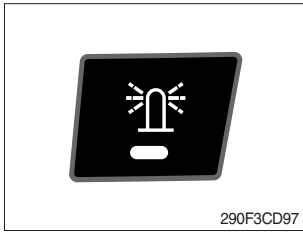

- ① This switch activates the rotary light on the cab.
- ② The pilot lamp lights up when this switch is pressed.

(14) Overload switch (opt)

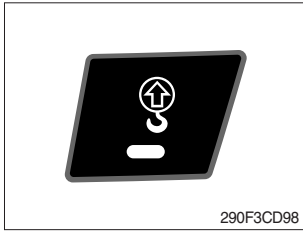

- ① When this switch is activated, buzzer makes sound and overload warning lamp lights up in the event that the machine is or becomes in an overloaded situation.
- ② When the switch is inactivated, buzzer stops and warning lamp goes off.

⚠ Overloading the machine could impact the machines stability which could result in tipover hazard. A tipover hazard could result in serious injury or death. Always activate the overload warning device before you handle or lift objects.

(15) Travel alarm switch

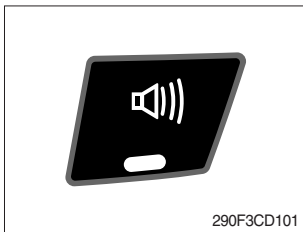

- ① This switch is to activate travel alarm function surrounding when the machine travels.
 - ON : The travel alarm function is activated.
 - OFF : The travel alarm function is not activated.

(16) Main menu quick touch switch



- ① This switch is to activate the main menu in the cluster.
 - ※ Refer to page 5-85.

8) MAIN MENU

※ You can select or set the menu by the touch screen.

On the operation screen, tap MENU to access the main menu screen.



On the sub menu screen, you can tap the menu bar to access functions or applications.

· Operation screen



130A3CD40

(1) Structure

| No | Main menu | Sub menu | Description |
|----|---|--|--|
| 1 |  Mode 290F3CD103 | Work mode U mode power Boom/Arm speed Auto power boost IPC mode Auto engine shutdown (option) Initial mode Emergency mode | Breaker, Crusher, Not installed User mode only Boom speed, Arm speed Enable, Disable Speed mode, Balance mode, Efficiency mode One time, Always, Disable Key on initial mode, Accel initial mode / step Switch function |
| 2 |  Monitoring 290F3CD104 | Active fault Logged fault Delete logged fault Monitoring | MCU, Engine ECM MCU, Engine ECM All logged fault delete, Initialization canceled Machine information, Switch status, Output status, |
| 3 |  Management 290F3CD105 | Fuel rate information Maintenance information Machine security Machine information Contact Update | General record, Hourly, Daily, Mode record Replacement, Change interval oils and filters ESL mode setting, Password change Model, MCU, Monitor, switch controller, RMCU, Relay drive unit, AAVM (opt) A/S phone number, A/S phone number change Cluster, ETC device |
| 4 |  Display 290F3CD106 | Display item Clock Brightness Unit setup Language selection Screen type | Engine speed, Tripmeter A, Tripmeter B, Tripmeter C Clock Manual, Auto Temperature, Pressure, Flow, Distance, Date format Korean, English, ETC A type, B type |
| 5 |  Utilities 290F3CD107 | Tripmeter Camera | 3 kinds (A, B, C) Number of active, Display order, AAVM (opt) |

(2) Mode setup

① Work mode



235A3CD41A



235A3CD42A

A



235A3CD43A

B

- Select installed optional attachment
 - A : It can set the user's attachment.
It is available in setting #1~#10.
 - B : Max flow - Set the maximum flow for the attachment.
Relief pressure - Set the relief pressure.

② U mode power



235A3CD44A



235A3CD45A

- Engine high idle rpm, auto idle rpm and pump torque (power shift) can be modulated and memorized separately in U-mode.
- U-mode can be activated by user mode switch.

| Step (■) | Engine speed (rpm) | Idle speed (rpm) | Power shift (bar) |
|----------|--------------------|-------------------|-------------------|
| 1 | 1300 | 750 | 0 |
| 2 | 1400 | 800 | 3 |
| 3 | 1500 | 850 | 6 |
| 4 | 1600 | 900 | 9 |
| 5 | 1700 | 950 | 12 |
| 6 | 1800 | 1000 | 16 |
| 7 | 1850 | 1050 | 20 |
| 8 | 1900 | 1100 | 26 |
| 9 | 1950 | 1150 | 32 |
| 10 | 2000 | 1200 (auto decel) | 38 |

※ One touch decel & low idle : 1100 rpm

③ Auto power boost



- The power boost function can be activated or cancelled.
 - Enable - The digging power is automatically increased as working conditions by the MCU. It is operated max seconds, then goes off for a period of 1 second and then activates again for 8 seconds and continues this cycle.
 - Disable - Not operated.

④ IPC mode



- The IPC mode can be selected by this menu.
 - Speed mode
 - Balance mode (default)
 - Efficiency mode
- ※ Please update the cluster programs if this mode is not displayed in the mode setup menu. Refer to the page 5-96.

⑤ Automatic engine shutdown



235A3CD58A



235A3CD59A



130A3CD60

- The automatic engine shutdown function can be set by this menu.
- One time
- Always
- Disable
- Wait time setting : Max 40 minutes, min 2 minutes

⑥ Initial mode



235A3CD61A



130A3CD62

- **Key on initial mode**
 - Selected the power mode is activated when the engine is started.
- **Key on initial work mode**
 - Not installed
 - Last setting
 - Work mode
- **Accel initial mode**
 - Last setting value
 - User setting value

⑦ Emergency mode



235A3CD63



235A3CD64A

- This mode can be used when the switches are abnormal on the cluster.
- The cluster switches can be selected by touching each icon.

(3) Monitoring

① Active fault



- The active faults of the MCU, ECM, AAVM (option) can be checked by this menu.

② Logged fault

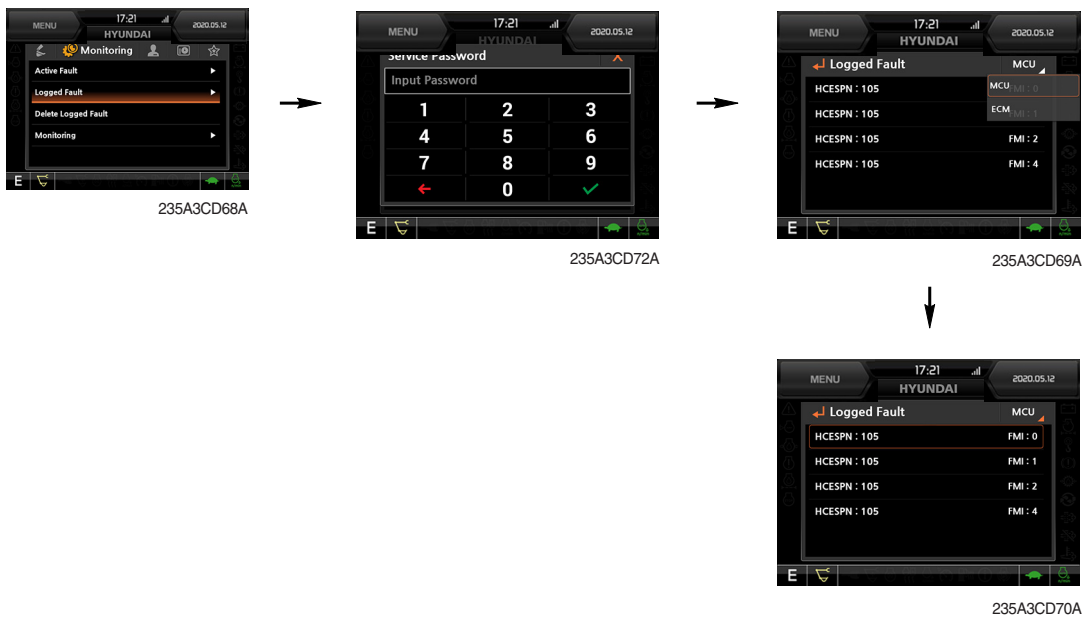

- The logged faults of the MCU, ECM, AAVM (option) can be checked by this menu.

③ Delete logged fault



- The logged faults of the MCU, ECM, AAVM (option) can be deleted by this menu.

④ Monitoring

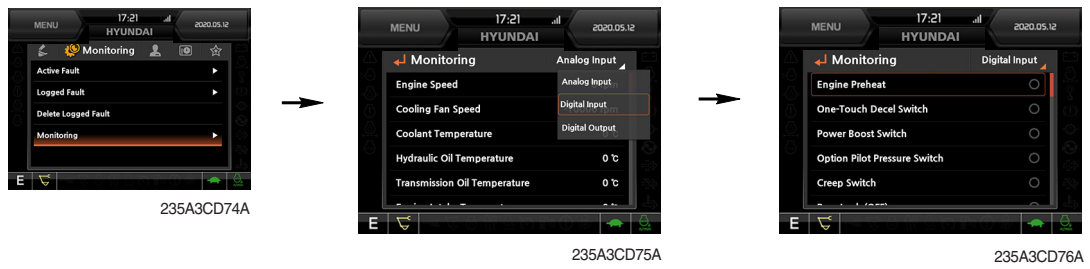

- The machine status such as the engine rpm, oil temperature, voltage and pressure etc. can be checked by this menu (Analog input).
- The switch status or output status can be confirmed by this menu (Digital input & Digital output).
- The activated switch or output pilot lamps ● will light up.

(4) Management

① ECO report

This reports the machine's inefficient operation status in order to improve operator's improper working habit.



High idle



Idle



- Shows a breakdown of high idle, idle and relief operation when monitor is on.
- Gives a daily usage breakdown record for a 7 day period and an overall accumulated record from the first operation.

Relief operation



② Fuel rate information



235A3CD81A



235A3CD82A

A



235A3CD83A

B



235A3CD84A

C



235A3CD85A

D



235A3CD86A

· General record (A)

- Average fuel rate (left) (from "Reset" to now)
Fuel consumption divided by engine run time (service meter time).
- A days fuel used (right)
Fuel consumption from 24:00 (or "Reset" time) to now (MCU real time).

· Hourly record (B)

- Hourly fuel rates for past 12 hours (service meter time).
- No record during key-off time.
- One step shift to the right for every one hour.
- Automatic deletion of data from 12 hours and earlier.
- "Reset" deletes all hourly records.

· Daily record (C)

- Daily fuel consumption for past seven days (MCU real time).
- No record during key-off time.
- One step shift to the right at 24:00 for every day.
- Automatically deletes data from 7 days and earlier.
- All daily records deletion by "Reset".

· Mode record (D)

- Average fuel rate for each power mode/accel dial (at least 7) from "Reset" till present.
- No record during idle.
- All records can be deleted by "Reset".

③ Maintenance information



235A3CD87A



235A3CD88A



235A3CD89A

- Alarm lamp (●) is ON when oil or filter needs to be changed or replaced.
- Replacement : The elapsed time will be reset to zero (0).
- Change interval : The change intervals can be changed in hour increments of 50.
- **Change or replace interval : Refer to maintenance.**

④ Machine security



235A3CD90A



235A3CD91A

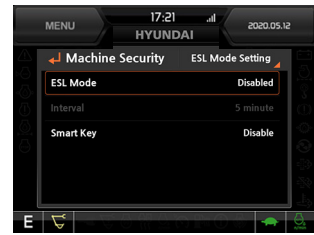

235A3CD92A

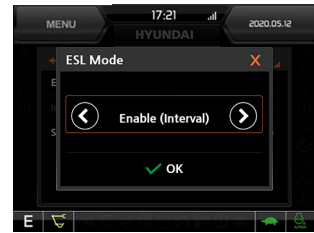

235A3CD93A

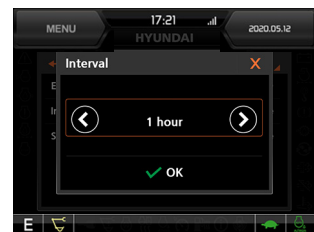

235A3CD94A

· ESL mode setting

- ESL : Engine Starting Limit
- ESL mode is designed to be a theft deterrent or will prevent the unauthorized operation of the machine.
- When you Enable the ESL mode, the password will be required when the starting switch is turned to the on position.

- Machine security

Disable : ESL function is disabled and password is not required to start engine.

Enable (always) : The password is required whenever the operator starts engine.

- **Interval** : The password is required when the operator starts engine first. But the operator can restart the engine within the interval time without inputting the password. The interval time can be set to a maximum 4 hours.

※ Default password : 00000 + ✓

※ Password length : (5~10 digits) + ✓

- Smart key (option) : Refer to next page.

· Password change

- The password is 5~10 digits.



235A3CD95A



235A3CD96A



130A3CD97

Enter the current password

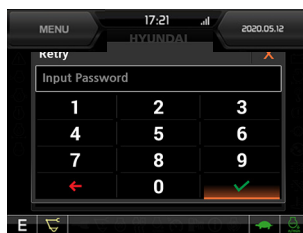

235A3CD98A

Enter the new password again



235A3CD99A

Enter the new password

※ Before first use, please set user password and owner password in advance for machine security.

- Smart key



- Smart key is registered when equipped with optional smart key. If smart key is not inside of the cabin, authentication process fails and the password is needed.
- Tag management menu is activated when the Smart key menu is Enabled.
You can register and delete the tags.

- Tag management

- When registering a tag : Only the tag you want to register must be in the cabin.
- When deleting a tag : All registered tags are deleted.

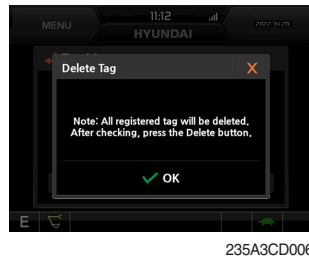
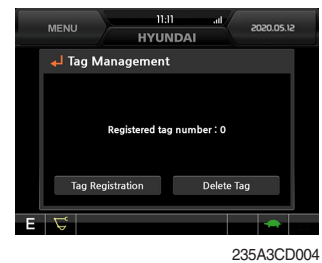
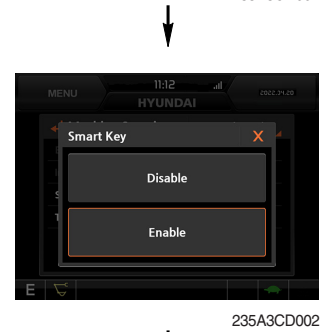

Deleting ←

Registering ↓

⑤ Machine Information



235A3CD100A



235A3CD101A

- This can confirm the identification of the model information (ECU), MCU, monitor, switch controller, RMCU, relay driver unit, AAVM (opt).

⑥ Contact (A/S phone number)



235A3CD102A



235A3CD103A



235A3CD104A

Enter the new A/S phone number

⑦ Clinometer



235A3CD108A



235A3CD109A

- When the machine is on the flatland, if you touch "initialization" on cluster, the values of X, Y will reset to "0".
- You can confirm tilt of machine in cluster's operating screen.

⑧ Update (cluster & ETC devices)

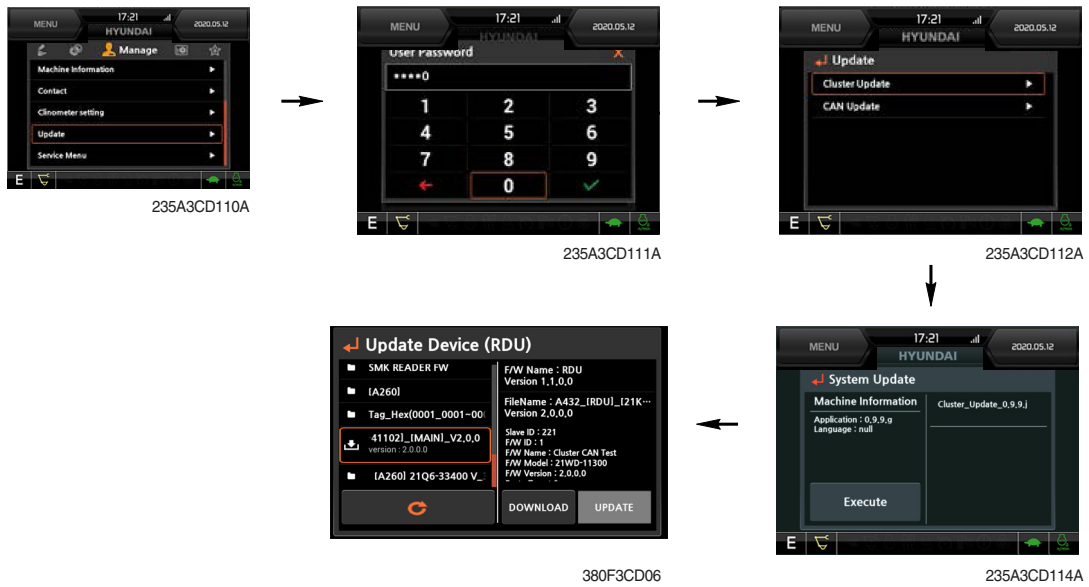

- ETC devices and cluster can be updated through CAN 2 network.
- Insert USB memory stick which includes program files, start download.

⑨ OME (owner menu editing)

The owner of machine can restrict operator access to set functions.

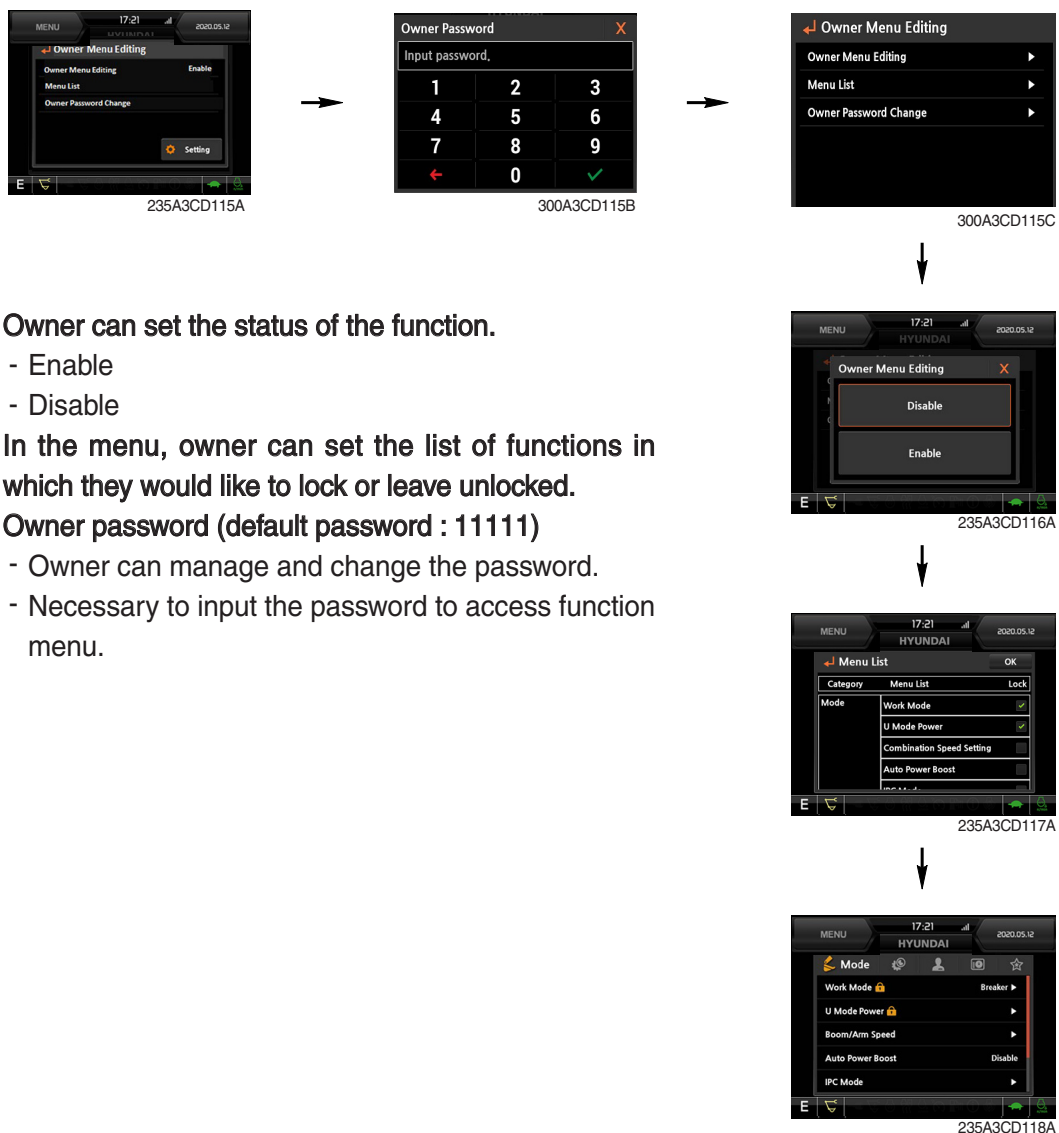

- **Owner can set the status of the function.**
 - Enable
 - Disable
- In the menu, owner can set the list of functions in which they would like to lock or leave unlocked.
- **Owner password (default password : 1111)**
 - Owner can manage and change the password.
 - Necessary to input the password to access function menu.

(5) Display

① Display item



- The center display type of the LCD can be selected by this menu.
- The engine speed or the tripmeter menu (A,B,C) is displayed on the center display.

② Clock



- The first row of boxes indicate Year/Month/Day.
- The second row shows the current time. (0:00~23:59)

③ Brightness



- If "Auto" is chosen, brightness for day and night can be set accordingly. Also by using the bar in lower side, users can define which an operation interval belongs to day and night. (in bar figure, white area represents night time while orange shows day time)

④ Unit



235A3CD130A

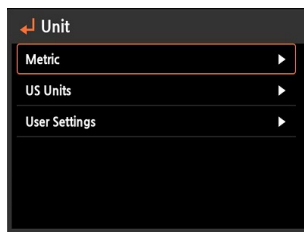

300A3CD130B



300A3CD130C

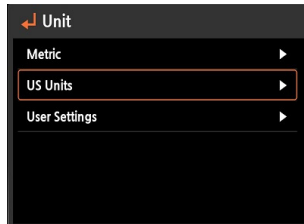

300A3CD130D

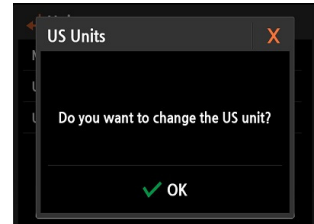

300A3CD130E

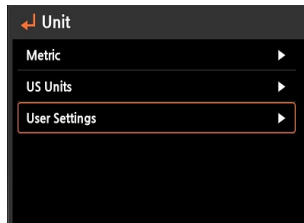

300A3CD130F

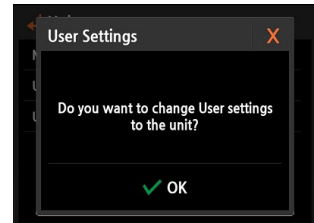

300A3CD130G



235A3CD131A



235A3CD132A

- Temperature : °C ↔ °F
- Pressure : bar ↔ MPa ↔ kgf/cm²
- Volume : l ↔ gal
- Flow : lpm ↔ gpm
- Distance : km ↔ mile
- Date format : yy/mm/dd ↔ mm/dd/yy ↔ dd-mm-yy

⑤ Language



- User can select preferable language and all displays are changed to the selected language.

(6) Utilities

① Tripmeter

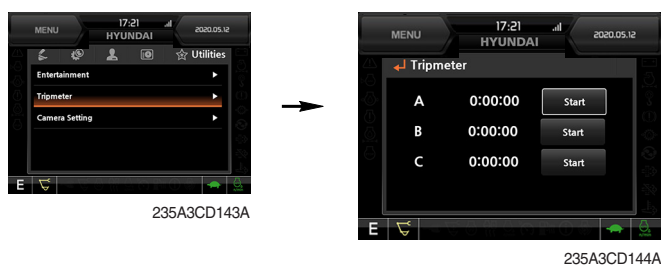

- A maximum of 3 types of tripmeters can be used at the same time.
- Each tripmeter can be turned on by choosing "Start" while it also can be turned off by choosing "Stop".
- If the tripmeter icon is activated in the operation screen, it can be controlled directly there.

② Camera setting

- If the rear camera is not installed on the machine, set disable.
- If the rear camera is installed on the machine, set enable.

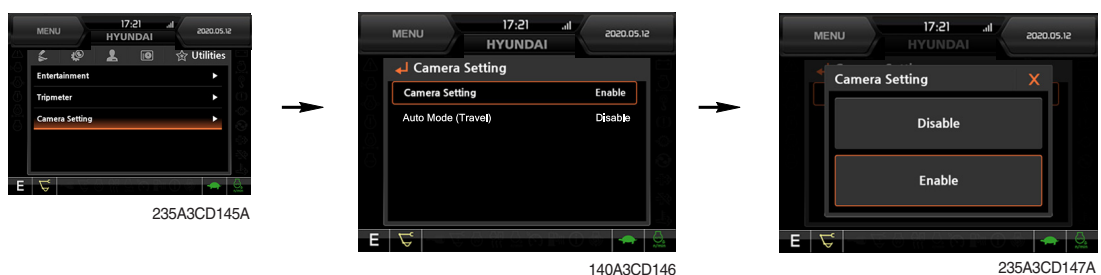

- In the operation screen, rear camera screen shows up when ESC/CAM switch is pushed.



③ **AAVM** (Advanced Around View Monitoring, option)

- The AAVM switches of the cluster consist of ESC/CAM and AUTO IDLE/Buzzer stop.



130A3CD149

- **Escape switch**

- Activates AAVM mode from the beginning if AAVM is installed.
- While in the AAVM mode, select the ESC switch to return to the home screen.



130A3CD97

Home screen



AAVM mode

235SA3CD222A

- **Buzzer stop switch**

- AAVM mode detects surrounding pedestrians or objects and the warning buzzer sounds.
- User can turn OFF the warning sound by pressing the buzzer stop switch.



220A3CD246

- When a worker/pedestrian reaches the green line, which is an external danger area equipped on the cluster, warning buzzer sounds and it displays a green rectangular box recognizing the worker/pedestrian. Stop work immediately. Stop the buzzer by pressing the buzzer stop switch. Then resume work after you confirm that the area is safe and clear of workers/objects.



220A3CD247

- When a worker/pedestrian reaches the red line, which is an internal danger area equipped on the cluster, warning buzzer sounds and it displays a red rectangular box recognizing the worker/pedestrian. Stop work immediately. Stop the buzzer by pressing the buzzer stop switch. Then resume work after you confirm that the area is safe and clear of workers/objects.

▲ Failure to comply may result in serious injury or death.

9) AIR CONDITIONER AND HEATER

Full auto air conditioner and heater system automatically keeps the optimum condition in accordance with operator's temperature configuration, sensing ambient and cabin inside temperature.

· Location of air flow ducts

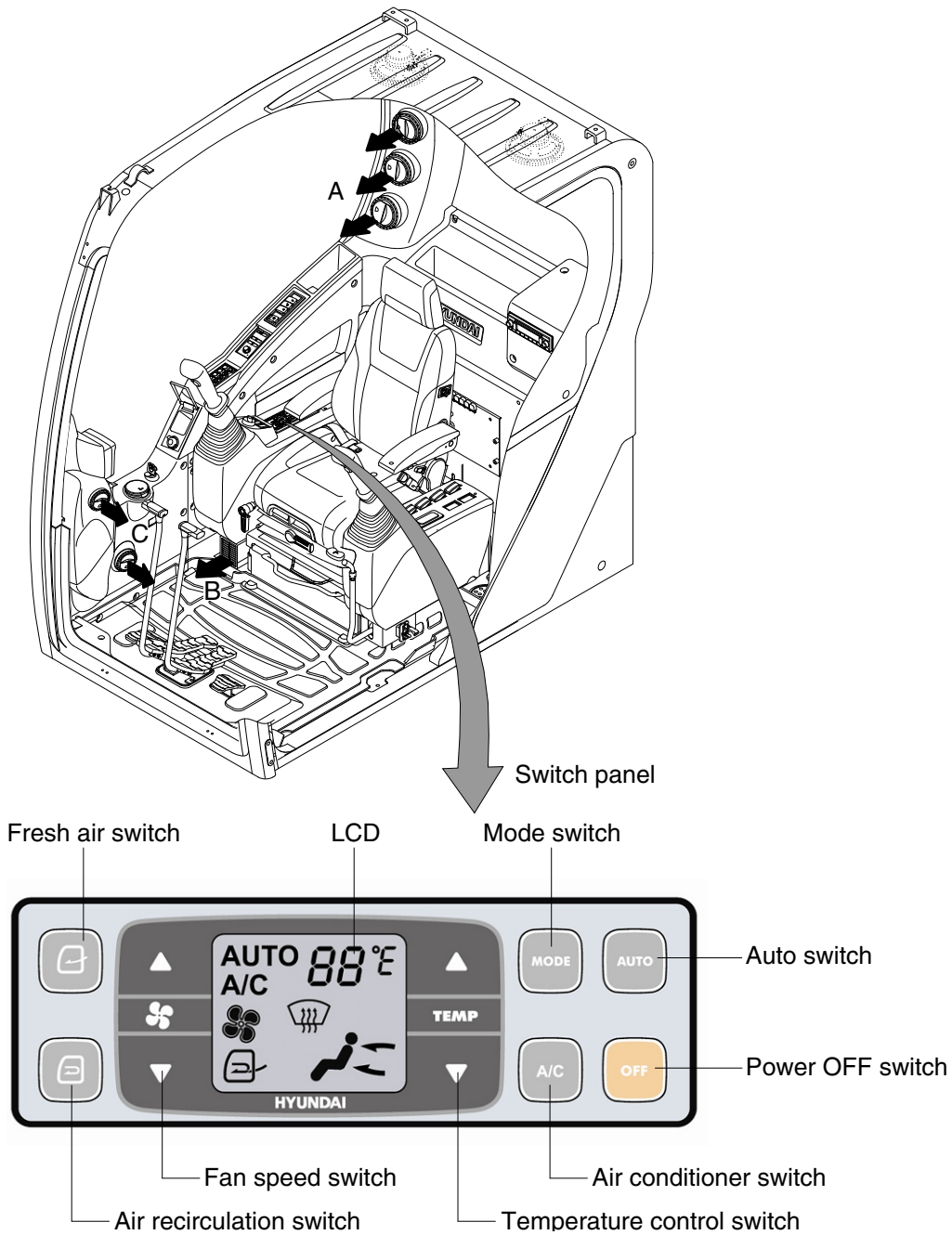

235F3CD06

(1) Power off switch

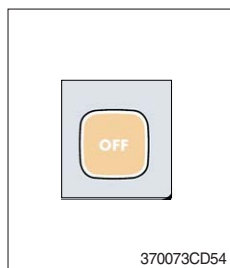

- ① This switch turns the system ON and OFF.
Just before powering OFF, set values are stored.

② Default setting values

| Function | Air conditioner | In/outlet | LCD | Temperature | Mode |
|----------|-----------------|-----------|-----|-----------------|-----------------|
| Value | OFF | Inlet | OFF | Previous sw OFF | Previous sw OFF |

(2) Auto switch

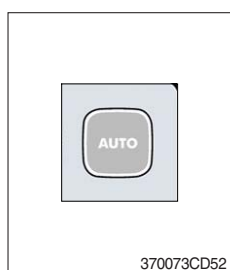

- ① Turn the starting switch to ON position, LCD lights ON.
Auto air conditioner and heater system automatically keeps the optimum condition in accordance with operator's temperature configuration sensing ambient and cabin inside temperature.
- ② This switch can restart system after system OFF.

(3) Air conditioner switch (compressor switch)

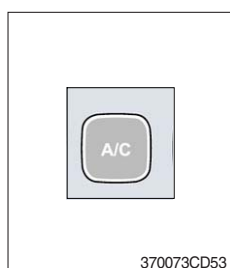

- ① This switch turns the compressor and the LCD ON.
 - ② In accordance with the temperature sensed by duct (evaporator) sensor, compressor turns ON or OFF automatically.
- ※ **Air conditioner operates to remove vapor and drains water through a drain hose. Water can be sprayed into the cab in case that the drain cock at the ending point of drain hose has a problem. In this case, exchange the drain cock.**

(4) Fan speed switch

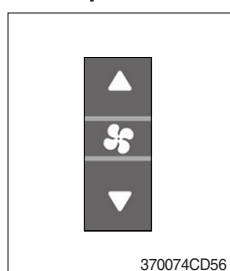

- ① Fan speed is controlled automatically by setted temperature.
- ② This switch controls fan speed manually.
 - There are 8 up/down steps to control fan speed.
 - The maximum step or the minimum step beeps 5 times.
- ③ This switch makes the system ON.

(5) Temperature control switch

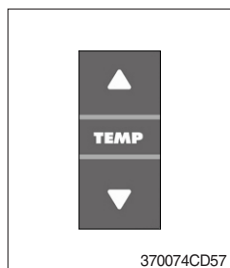

- ① Setting temperature indication
 - a. Type A : 17~32°C, scale : 1°C
 - b. Type B : Lo, 18~31°C, Hi, scale : 1°C
- ② Max cool and max warm beeps 5 times.
- ③ The max cool or the max warm position operates per the following table.

| Temperature | Compressor | Fan speed | In/Outlet | Mode |
|-------------|------------|-----------|---------------|------|
| Max cool | ON | Max (Hi) | Recirculation | Vent |
| Max warm | OFF | Max (Hi) | Fresh | Foot |

- ④ Temperature unit can be changed between celsius (°C) and fahrenheit (°F)
 - a. Default status (°C)
 - b. The temperature unit can be changed (°C ↔ °F) by pressing temperature switches (Up/Down) simultaneously for more than 5 seconds.

(6) Mode switch

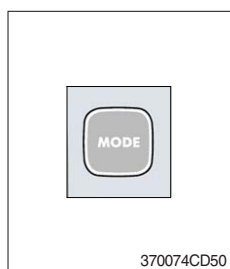

- ① Operating this switch, it beeps and displays symbol of each mode in the following order. (Vent → Vent/Foot → Def/Foot → Def/Vent → Def/Vent/Foot)

| Mode switch | | Vent | Vent/Foot | Def/Foot | Def/Vent | Def/Vent/Foot |
|-------------|---|------|-----------|----------|----------|---------------|
| | | | | | | |
| Outlet | A | ● | ● | | ● | ● |
| | B | | ● | ● | | ● |
| | C | | | ● | ● | ● |

- ② When operating defroster, FRESH AIR/AIR RECIRCULATION switch turns to FRESH AIR mode and air conditioner switch turns ON.

(7) FRESH AIR/AIR RECIRCULATION SWITCH

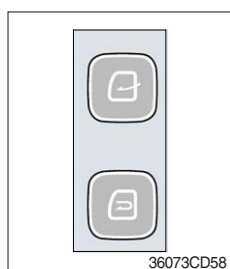

- ① It is possible to change the air-inlet method.
 - a. **Fresh air** ()
Inhaling air from the outside.
※ **Check out the fresh air filter periodically to keep a good efficiency.**
 - b. **Air recirculation** ()
It recycles the heated or cooled air to increase the energy efficiency.
※ **Change air occasionally when using recirculation for a long periods of time.**
※ **Check condition of fresh air filter and recirculation filter periodically to maintain good efficiency of the system.**

(8) Self diagnosis function

① Procedure

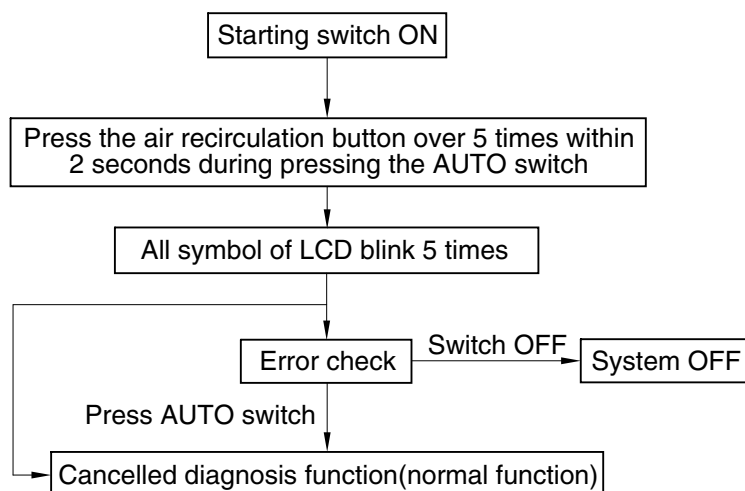

3607A3CD69

② Error check

- The corresponding error code flickers on the setup temperature display panel, the other symbol will turn OFF.
- Error code flickers every 0.5 second.
- If error code is more than two, each code flickers 2 times in sequence.
- Error code

| Error code | Description | Error code | Description |
|------------|--------------------------|------------|-----------------|
| 11 | Cabin inside sensor | 16 | Mode actuator 1 |
| 12 | Ambient sensor | 17 | Mode actuator 2 |
| 14 | Duct (evaporator) sensor | 18 | Intake actuator |
| 15 | Temp actuator | - | - |

③ Fail safe function

| Error description | Fail safe function |
|-------------------------------|--|
| Cabin inside sensor (11) | 25°C alternate value control |
| Ambient sensor (12) | 20°C alternate value control |
| Duct (evaporator) sensor (14) | 1°C alternate value control |
| Temp actuator (15) | If opening amount is 0 %, the alternate value is 0 % |
| | If not, the alternate value is 100 % |
| Mode actuator 1, 2 (16, 17) | The alternate value is vent |

GROUP 16 FUEL WARMER SYSTEM

1. SPECIFICATION

- 1) Operating voltage : 24±4 V
- 2) Power : 350±50 W
- 3) Current : 15 A

2. OPERATION

- 1) The current of fuel warmer system is automatically controlled without thermostat according to fuel temperature.
 - 2) At the first state, the 15 A current flows to the fuel warmer and engine may be started in 1~2 minutes.
 - 3) If the fuel starts to flow, ceramic-disk in the fuel warmer heater senses the fuel temperature to reduce the current as low as 1.5 A.
- So, fuel is protected from overheating by this mechanism.

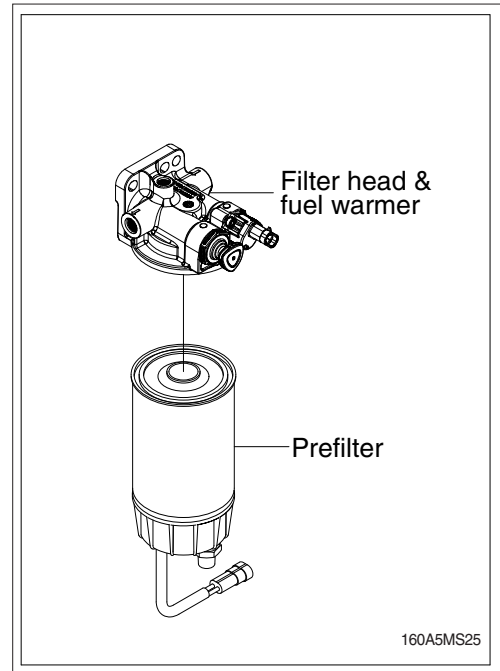

3. ELECTRIC CIRCUIT

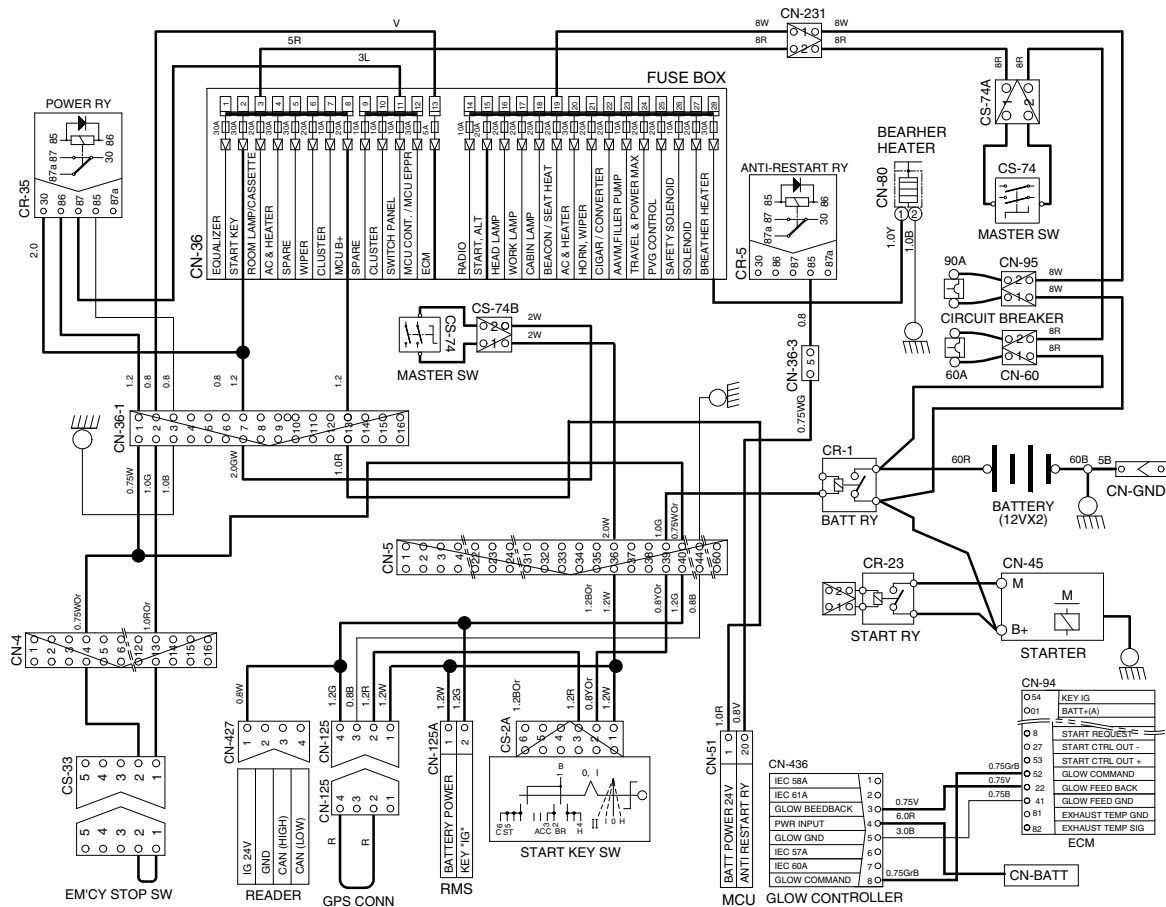

130ZF5MS103

GROUP 17 1 or 2-WAY OPTIONAL PIPING PRESSURE REMOVAL SYSTEM

■ Machine serial no. : #0213~

1. OUTLINE

This system can be removed the residual pressure of the optional attachment hydraulic piping when the quick coupler is operated by the switch of the RCV lever and then the oil quick function of the optional attachment is performed.

※ Oil quick function

In a convention work, the optional attachments such as breaker or grab are installed on the machine and needed to connect hydraulic piping additionally.

But currently, the hydraulic piping connection is not needed by the work man. The attachment is installed on the machine and the hydraulic pipings are connected by a coupler that is built in the quick coupler automatically and the attachment can be ready to operate immediately. This is called the oil quick function.

2. OPERATING PRINCIPLE

This is operated by controlling the setting pressure of the electric type relief valve when you operate the quick coupler with the switch of the RCV lever.

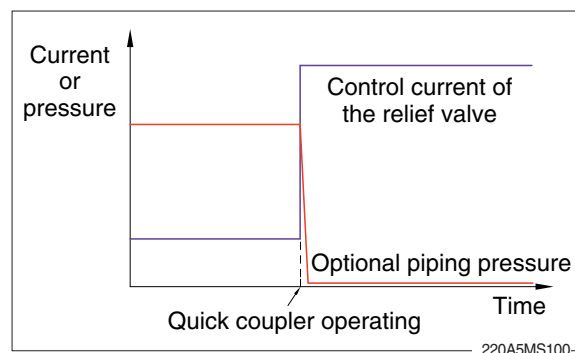

3. SETTING METHOD

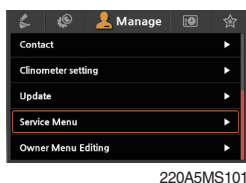

220A5MS101

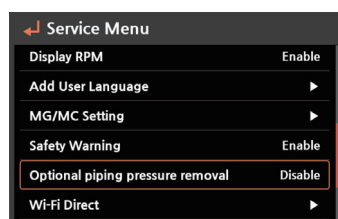

220A5MS102

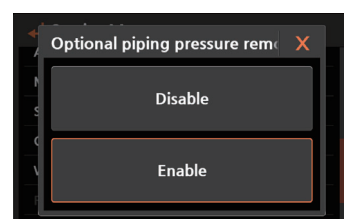

220A5MS103

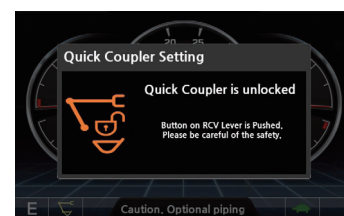

220A5MS104

- 1) Optional piping pressure removal is set to Disable in the factory.
- 2) Optional piping pressure removal is set to Enable then the oil quick function is operated. Also, the caution letter is display on the lower side of the cluster.
- 3) The setting condition is saved even if shut the engine off.

4. CAUTION

- 1) When the oil quick function is used, the hydraulic drift and etc can be occurred as the modified equipment specification.
- 2) The status of the cluster must be changed by a manager that is well-acquainted with the function and the operator must be well-informed of the oil quick function and safety work.