

# SECTION 1 GENERAL



Group 1 Safety Hints .....	1-1
Group 2 Specifications .....	1-9

# SECTION 1 GENERAL

## GROUP 1 SAFETY

### FOLLOW SAFE PROCEDURE

Unsafe work practices are dangerous.  
Understand service procedure before doing work; do not attempt shortcuts.

### WEAR PROTECTIVE CLOTHING

Wear close fitting clothing and safety equipment appropriate to the job.

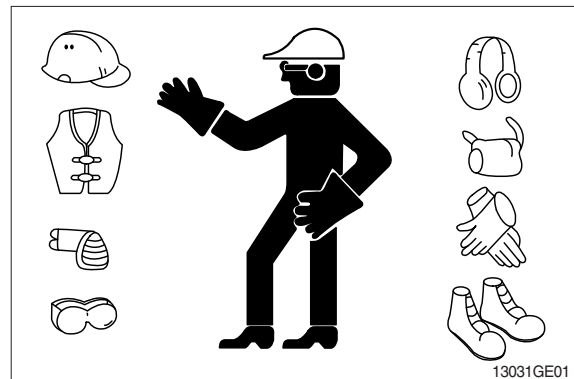

### WARN OTHERS OF SERVICE WORK

Unexpected machine movement can cause serious injury.  
Before performing any work on the excavator, attach a 「Do Not Operate」 tag on the right side control lever.

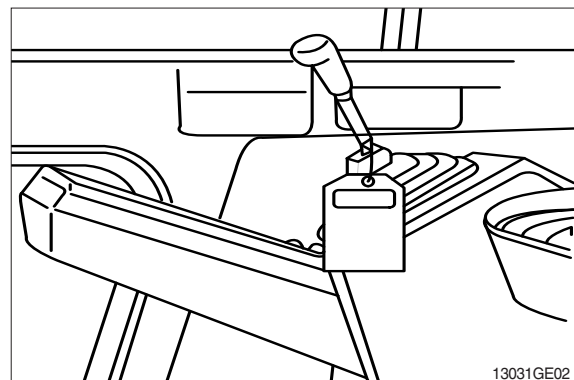

### USE HANDHOLDS AND STEPS

Falling is one of the major causes of personal injury.  
When you get on and off the machine, always maintain a three point contact with the steps and handrails and face the machine. Do not use any controls as handholds.  
Never jump on or off the machine. Never mount or dismount a moving machine.  
Be careful of slippery conditions on platforms, steps, and handrails when leaving the machine.

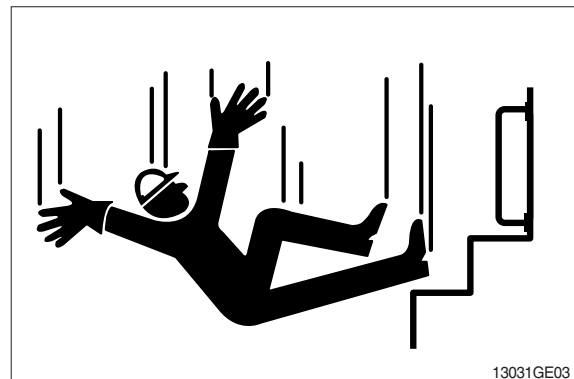

## PREPARE FOR EMERGENCIES

Be prepared if a fire starts.

Keep a first aid kit and fire extinguisher handy.

Keep emergency numbers for doctors, ambulance service, hospital, and fire department near your telephone.

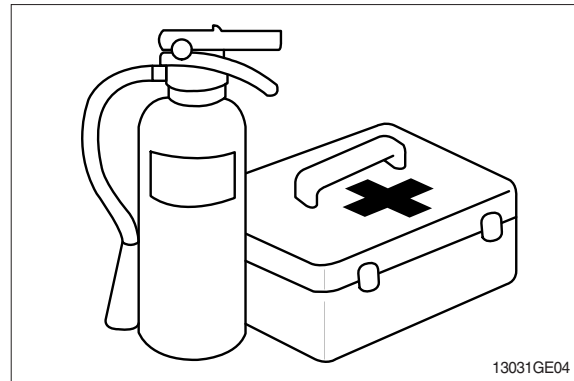

## PROTECT AGAINST FLYING DEBRIS

Guard against injury from flying pieces of metal or debris; wear goggles or safety glasses.

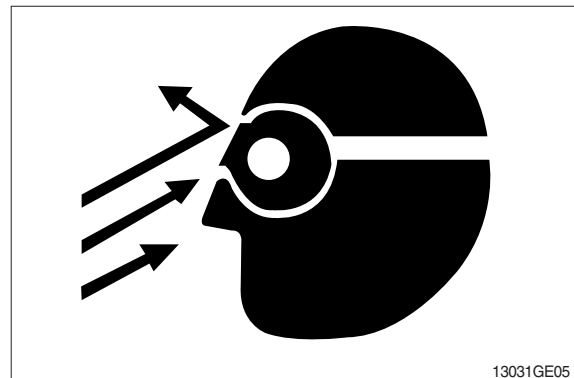

## PROTECT AGAINST NOISE

Prolonged exposure to loud noise can cause impairment or loss of hearing.

Wear a suitable hearing protective device such as ear-muffs or earplugs to protect against objectionable or uncomfortable loud noises.

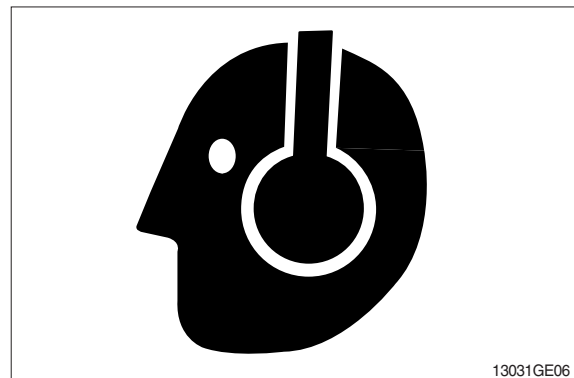

## AVOID POWER LINES

Serious injury or death can result from contact with electric lines.

Never move any part of the machine or load closer to electric line than 3m(10ft) plus twice the line insulator length.

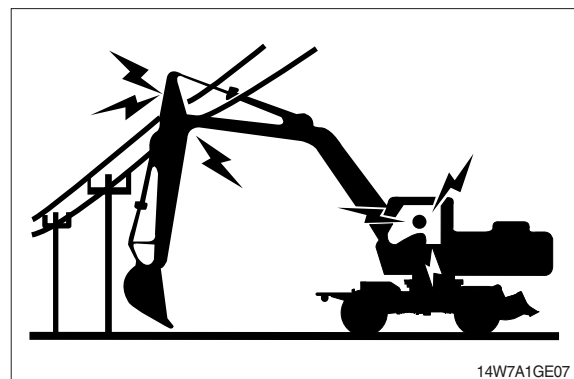

## KEEP RIDERS OFF EXCAVATOR

Only allow the operator on the excavator. Keep riders off.

Riders on excavator are subject to injury such as being struck by foreign objects and being thrown off the excavator. Riders also obstruct the operator's view resulting in the excavator being operated in an unsafe manner.

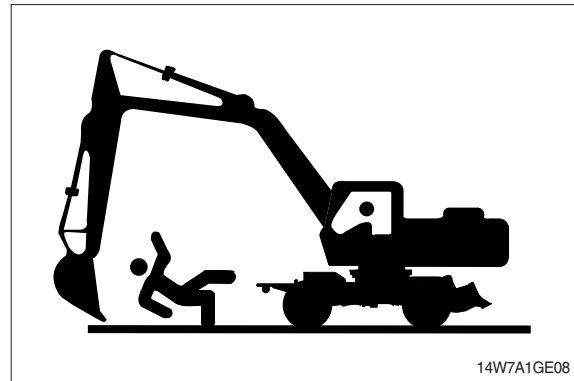

## MOVE AND OPERATE MACHINE SAFELY

Bystanders can be run over. Know the location of bystanders before moving, swinging, or operating the machine.

Always keep the travel alarm in working condition. It warns people when the excavator starts to move.

Use a signal person when moving, swinging, or operating the machine in congested areas. Coordinate hand signals before starting the excavator.

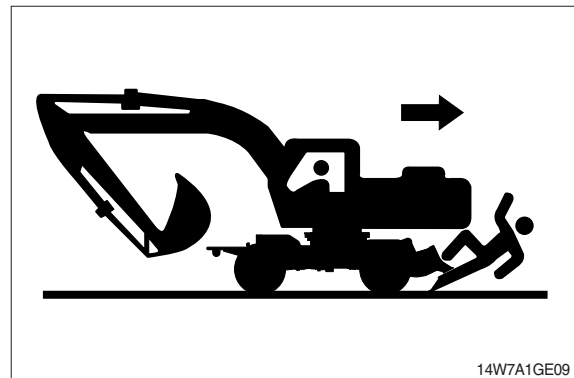

## OPERATE ONLY FROM OPERATOR'S SEAT

Avoid possible injury machine damage. Do not start engine by shorting across starter terminals.

NEVER start engine while standing on ground. Start engine only from operator's seat.



## PARK MACHINE SAFELY

Before working on the machine:

- Park machine on a level surface.
- Lower bucket to the ground.
- Turn auto idle switch off.
- Run engine at 1/2 speed without load for 2 minutes.
- Turn key switch to OFF to stop engine. Remove key from switch.
- Move pilot control shutoff lever to locked position.
- Allow engine to cool.

### SUPPORT MACHINE PROPERLY

Always lower the attachment or implement to the ground before you work on the machine. If you must work on a lifted machine or attachment, securely support the machine or attachment.

Do not support the machine on cinder blocks, hollow tiles, or props that may crumble under continuous load.

Do not work under a machine that is supported solely by a jack. Follow recommended procedures in this manual.

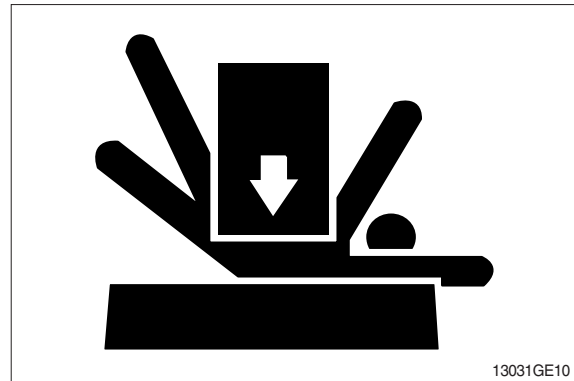

### SERVICE COOLING SYSTEM SAFELY

Explosive release of fluids from pressurized cooling system can cause serious burns.

Shut off engine. Only remove filler cap when cool enough to touch with bare hands.

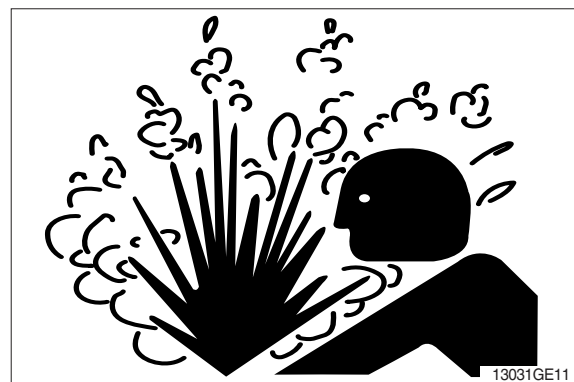

### HANDLE FLUIDS SAFELY-AVOID FIRES

Handle fuel with care; it is highly flammable. Do not refuel the machine while smoking or when near open flame or sparks. Always stop engine before refueling machine.

Fill fuel tank outdoors.

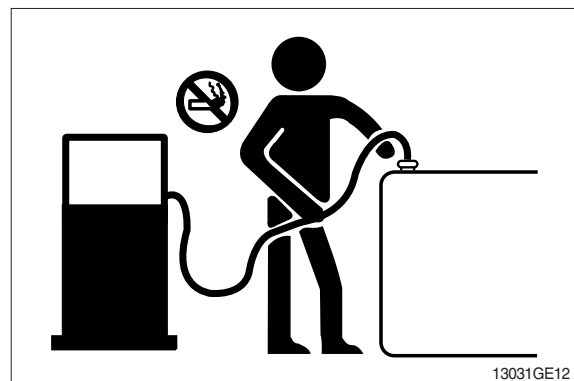

Store flammable fluids away from fire hazards. Do not incinerate or puncture pressurized containers.

Make sure machine is clean of trash, grease, and debris.

Do not store oily rags ; they can ignite and burn spontaneously.

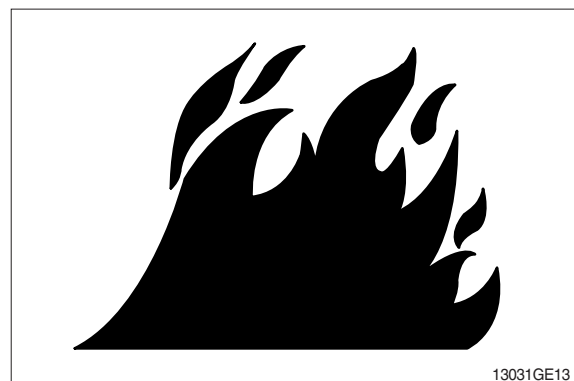

## BEWARE OF EXHAUST FUMES

Prevent asphyxiation. Engine exhaust fumes can cause sickness or death.

If you must operate in a building, be positive there is adequate ventilation. Either use an exhaust pipe extension to remove the exhaust fumes or open doors and windows to bring enough outside air into the area.

## REMOVE PAINT BEFORE WELDING OR HEATING

Avoid potentially toxic fumes and dust.

Hazardous fumes can be generated when paint is heated by welding, soldering, or using a torch.

Do all work outside or in a well ventilated area. Dispose of paint and solvent properly.

Remove paint before welding or heating:

- If you sand or grind paint, avoid breathing the dust.  
Wear an approved respirator.
- If you use solvent or paint stripper, remove stripper with soap and water before welding. Remove solvent or paint stripper containers and other flammable material from area. Allow fumes to disperse at least 15 minutes before welding or heating.

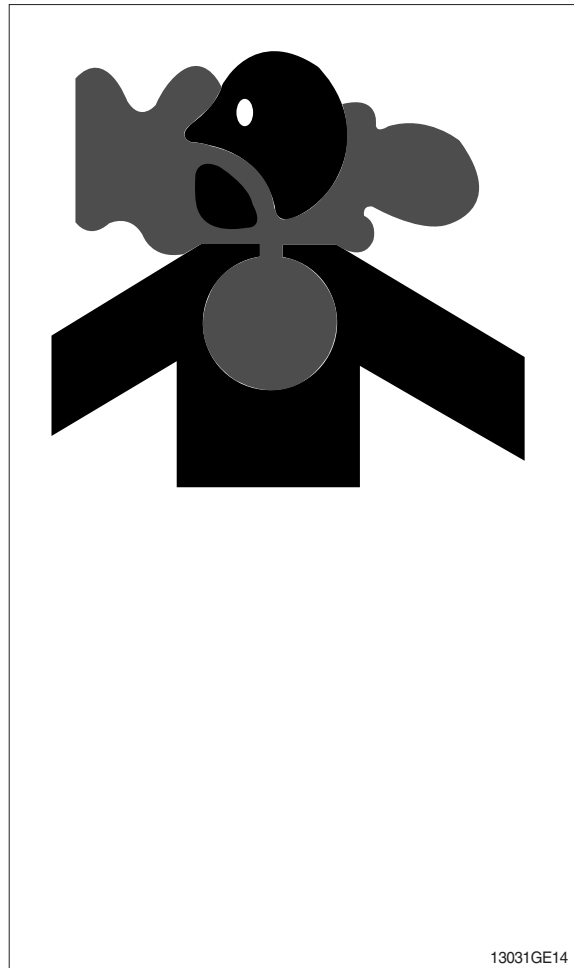

## ILLUMINATE WORK AREA SAFELY

Illuminate your work area adequately but safely. Use a portable safety light for working inside or under the machine. Make sure the bulb is enclosed by a wire cage. The hot filament of an accidentally broken bulb can ignite spilled fuel or oil.

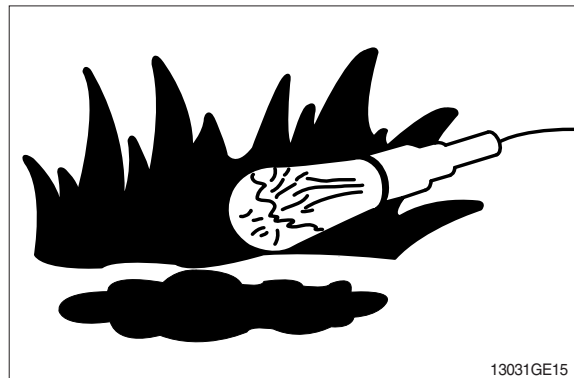

## SERVICE MACHINE SAFELY

Tie long hair behind your head. Do not wear a necktie, scarf, loose clothing or necklace when you work near machine tools or moving parts. If these items were to get caught, severe injury could result.

Remove rings and other jewelry to prevent electrical shorts and entanglement in moving parts.

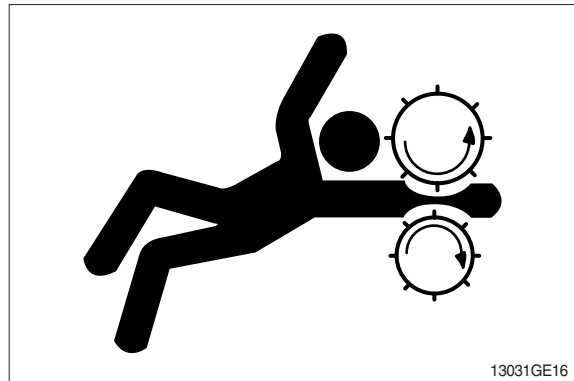

## STAY CLEAR OF MOVING PARTS

Entanglements in moving parts can cause serious injury.

To prevent accidents, use care when working around rotating parts.

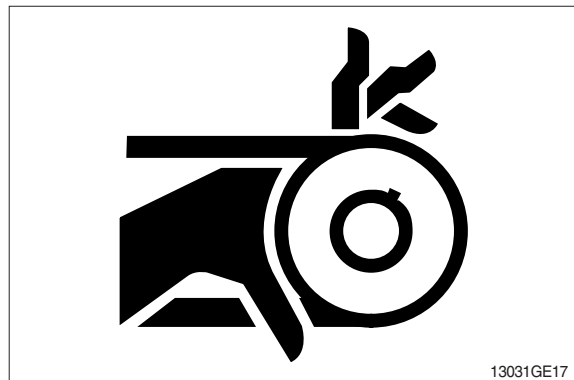

## AVOID HIGH PRESSURE FLUIDS

Escaping fluid under pressure can penetrate the skin causing serious injury.

Avoid the hazard by relieving pressure before disconnecting hydraulic or other lines. Tighten all connections before applying pressure.

Search for leaks with a piece of cardboard. Protect hands and body from high pressure fluids.

If an accident occurs, see a doctor immediately. Any fluid injected into the skin must be surgically removed within a few hours or gangrene may result.

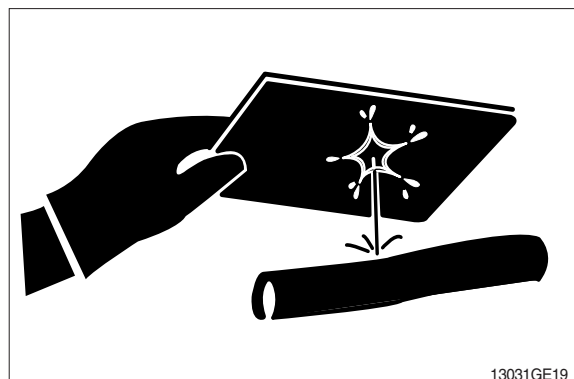

## AVOID HEATING NEAR PRESSURIZED FLUID LINES

Flammable spray can be generated by heating near pressurized fluid lines, resulting in severe burns to yourself and bystanders. Do not heat by welding, soldering, or using a torch near pressurized fluid lines or other flammable materials.

Pressurized lines can be accidentally cut when heat goes beyond the immediate flame area. Install fire resisting guards to protect hoses or other materials.



## PREVENT BATTERY EXPLOSIONS

Keep sparks, lighted matches, and flame away from the top of battery. Battery gas can explode.

Never check battery charge by placing a metal object across the posts. Use a volt-meter or hydrometer.

Do not charge a frozen battery; it may explode. Warm battery to 16°C (60°F).



## PREVENT ACID BURNS

Sulfuric acid in battery electrolyte is poisonous. It is strong enough to burn skin, eat holes in clothing, and cause blindness if splashed into eyes.

Avoid the hazard by:

1. Filling batteries in a well-ventilated area.
2. Wearing eye protection and rubber gloves.
3. Avoiding breathing fumes when electrolyte is added.
4. Avoiding spilling or dripping electrolyte.
5. Use proper jump start procedure.

If you spill acid on yourself:

1. Flush your skin with water.
2. Apply baking soda or lime to help neutralize the acid.
3. Flush your eyes with water for 10-15 minutes. Get medical attention immediately.

If acid is swallowed:

1. Drink large amounts of water or milk.
2. Then drink milk of magnesia, beaten eggs, or vegetable oil.
3. Get medical attention immediately.

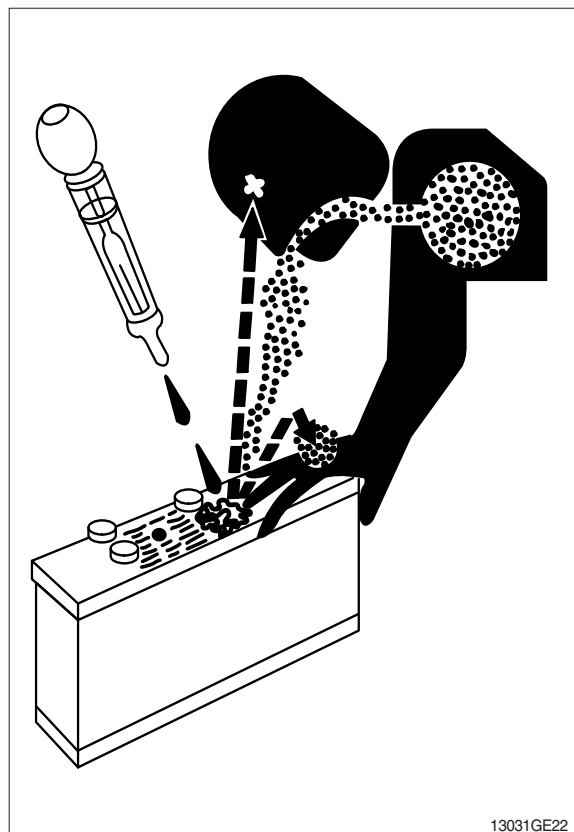



## USE TOOLS PROPERLY

Use tools appropriate to the work. Makeshift tools, parts, and procedures can create safety hazards.

Use power tools only to loosen threaded tools and fasteners.

For loosening and tightening hardware, use the correct size tools. DO NOT use U.S. measurement tools on metric fasteners. Avoid bodily injury caused by slipping wrenches.

Use only recommended replacement parts. (See Parts manual.)

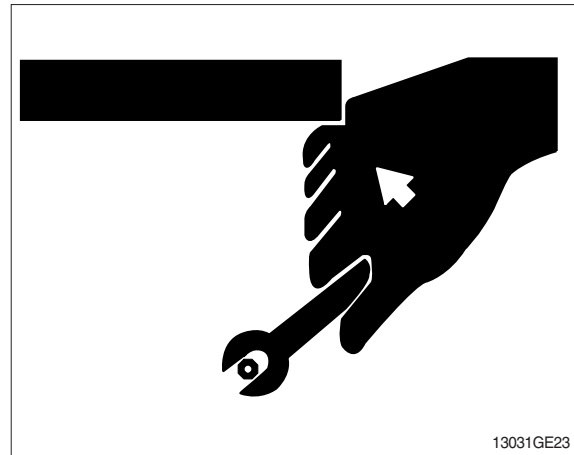

## DISPOSE OF FLUIDS PROPERLY

Improperly disposing of fluids can harm the environment and ecology. Before draining any fluids, find out the proper way to dispose of waste from your local environmental agency.

Use proper containers when draining fluids. Do not use food or beverage containers that may mislead someone into drinking from them.

DO NOT pour oil into the ground, down a drain, or into a stream, pond, or lake. Observe relevant environmental protection regulations when disposing of oil, fuel, coolant, brake fluid, filters, batteries, and other harmful waste.

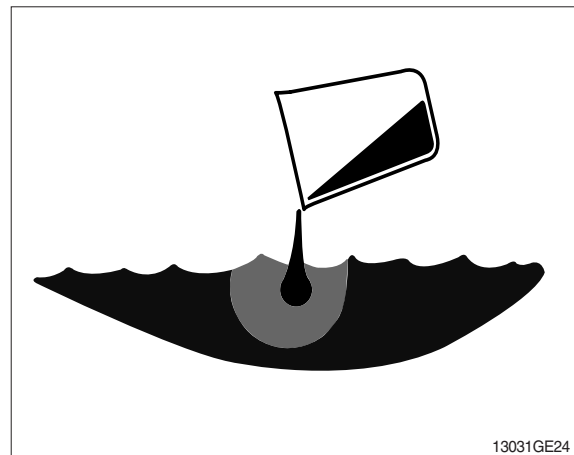

## REPLACE SAFETY SIGNS

Replace missing or damaged safety signs. See the machine operator's manual for correct safety sign placement.

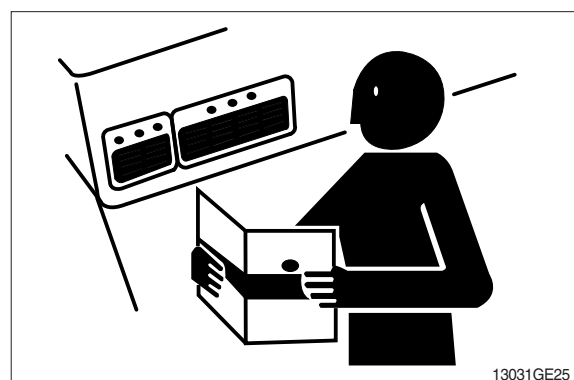

## LIVE WITH SAFETY

Before returning machine to customer, make sure machine is functioning properly, especially the safety systems. Install all guards and shields.

# GROUP 2 SPECIFICATIONS

## 1. MAJOR COMPONENT

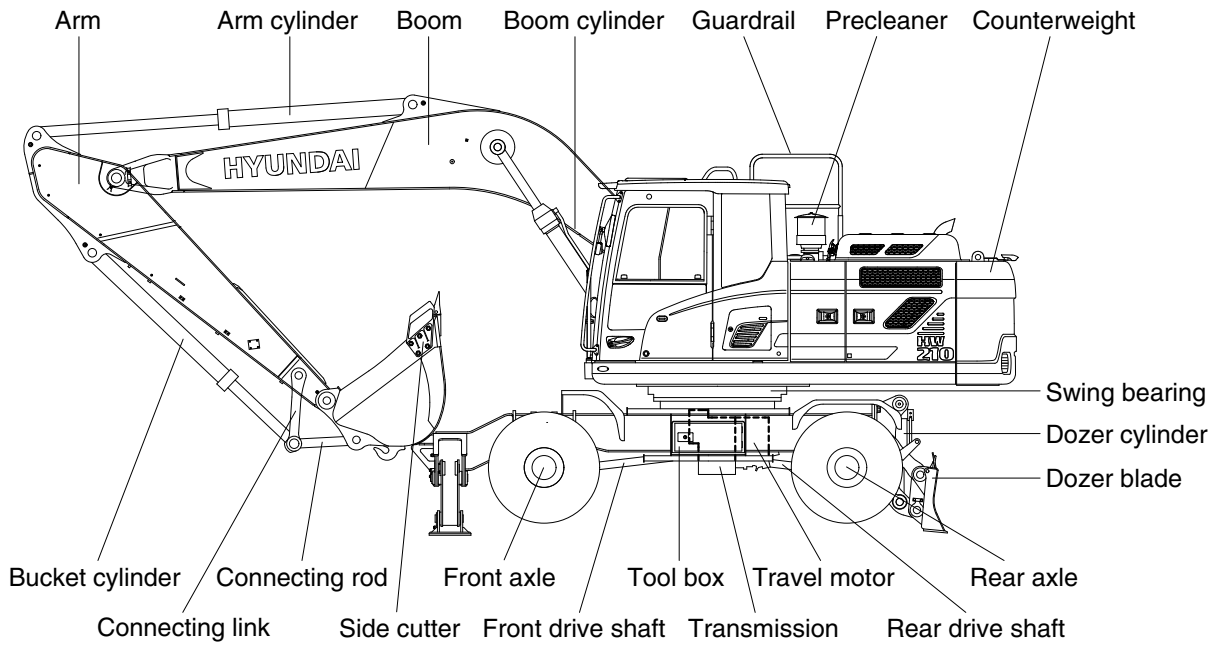
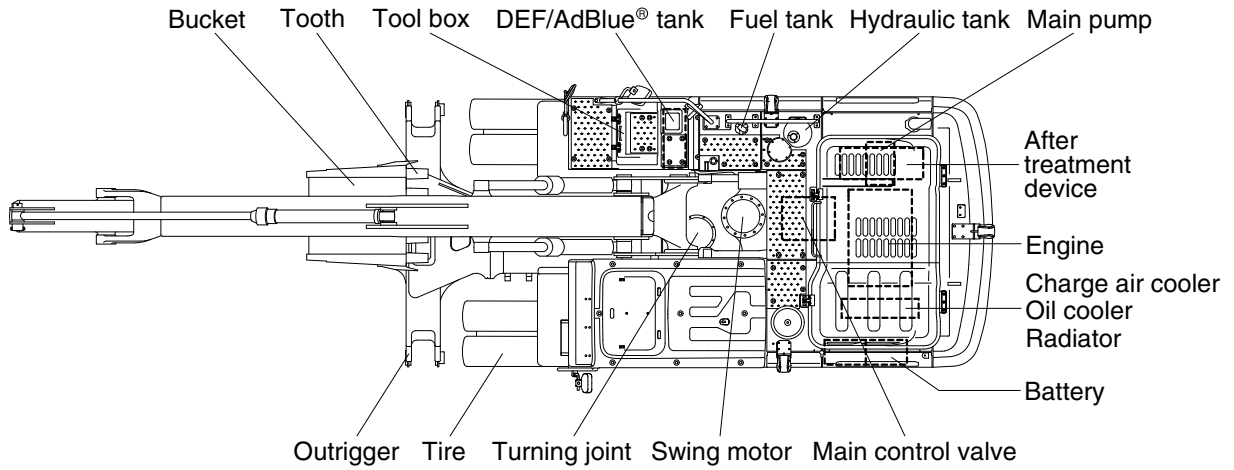

210WF2SP01

## 2. SPECIFICATIONS

### 1) 5.65 m (18' 6") MONO BOOM, 2.92 m (9' 7") ARM, FRONT OUTRIGGER AND REAR DOZER BLADE

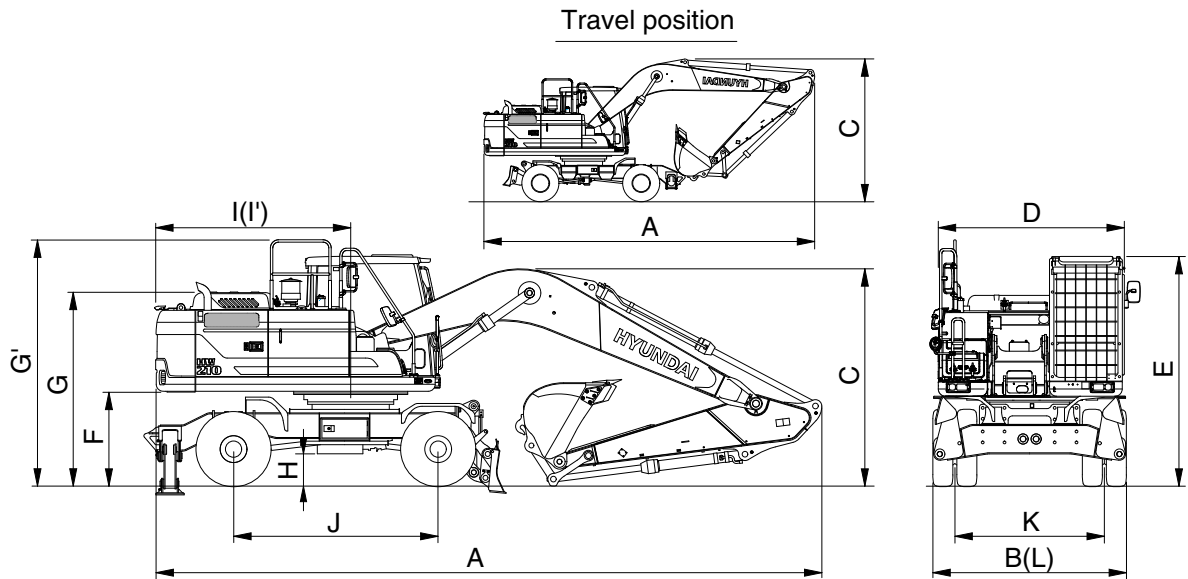

210WF2SP02

Description		Unit	Specification	
Operating weight		kg (lb)	21200 (46740)	
Bucket capacity (SAE heaped)		m <sup>3</sup> (yd <sup>3</sup> )	0.87 (1.14)	
Overall length (travel/shipping)	A	mm (ft-in)	9450 (31' 0")/9500 (31' 2")	
Overall width (axle / wide axle)	B		2530 (8' 4") / 2730 (8' 11")	
Overall height of boom (travel/shipping)	C		3950 (12' 9")/3130 (10' 3")	
Upperstructure width	D		2530 (8' 4")	
Cab height	E		3245 (10' 8")	
Ground clearance of counterweight	F		1300 (4' 3")	
Overall height of engine hood	G		2705 (8' 10")	
Overall height of guardrail	G'		3134 (10' 3")	
Ground to mission cover	H		353 (1' 2")	
Rear-end distance	I		2770 (9' 1")	
Rear-end swing radius	I'		2850 (9' 4")	
Wheel base	J		2800 (9' 2")	
Tread (axle / wide axle)	K		1914 (6' 3") / 2114 (6' 9")	
Dozer blade width	L		2490 (8' 2")	
Travel speed	Low		km/hr (mph)	9.1 (5.7)
	High			35 (21.7)
Swing speed		rpm	9.7	
Gradeability		Degree (%)	31.5 (61)	
Max traction force		kgf (lbf)	11600 (25570)	

2) 5.39 m (17' 8") 2-PIECE BOOM, 2.4 m (7' 10") ARM, FRONT OUTRIGGER AND REAR DOZER BLADE

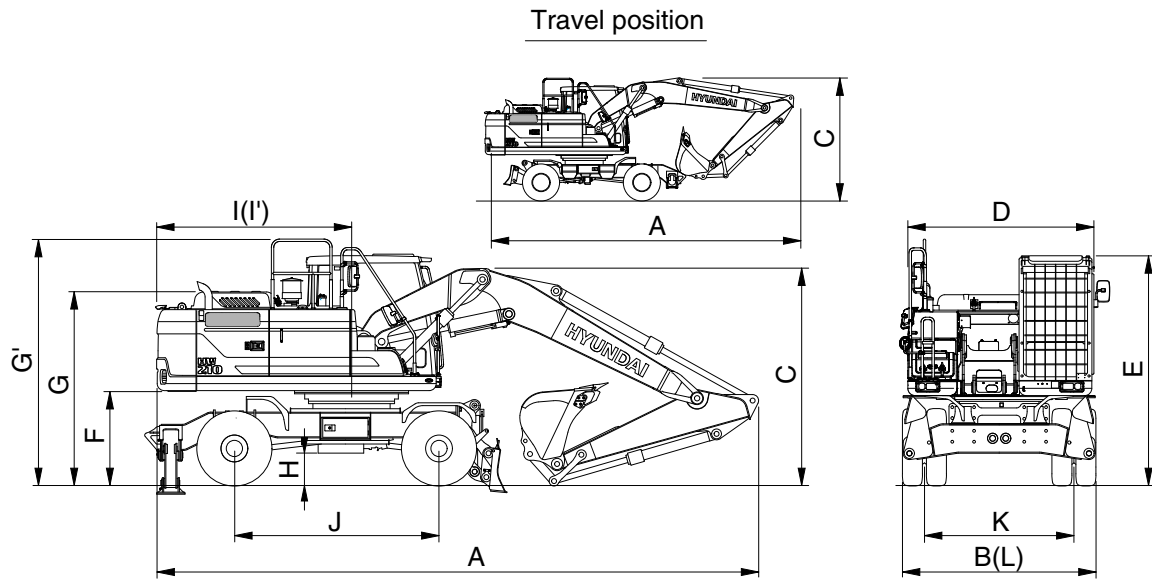

210WF2SP03

Description		Unit	Specification
Operating weight		kg (lb)	21450 (47290)
Bucket capacity (SAE heaped)		m <sup>3</sup> (yd <sup>3</sup> )	0.87 (1.14)
Overall length (travel/shipping)	A	mm (ft-in)	7130 (23' 5")/9350 (30' 7")
Overall width (axle / wide axle)	B		2530 (8' 4") / 2700 (8' 9")
Overall height of boom (travel/shipping)	C		4000 (13' 1")/3050 (10' 0")
Upperstructure width	D		2530 (8' 4")
Cab height	E		3245 (10' 8")
Ground clearance of counterweight	F		1300 (4' 3")
Overall height of engine hood	G		2705 (8' 10")
Overall height of guardrail	G'		3134 (10' 3")
Ground to mission cover	H		353 (1' 2")
Rear-end distance	I		2770 (9' 1")
Rear-end swing radius	I'		2850 (9' 4")
Wheel base	J		2800 (9' 2")
Tread (axle / wide axle)	K		1914 (6' 3") / 2114 (6' 9")
Dozer blade width	L		2490 (8' 2")
Travel speed	Low		km/hr (mph)
	High	35 (21.7)	
Swing speed		rpm	9.7
Gradeability		Degree (%)	31.5 (61)
Max traction force		kgf (lbf)	11600 (25570)

### 3. WORKING RANGE

#### 1) 5.65 m (18' 6") MONO BOOM

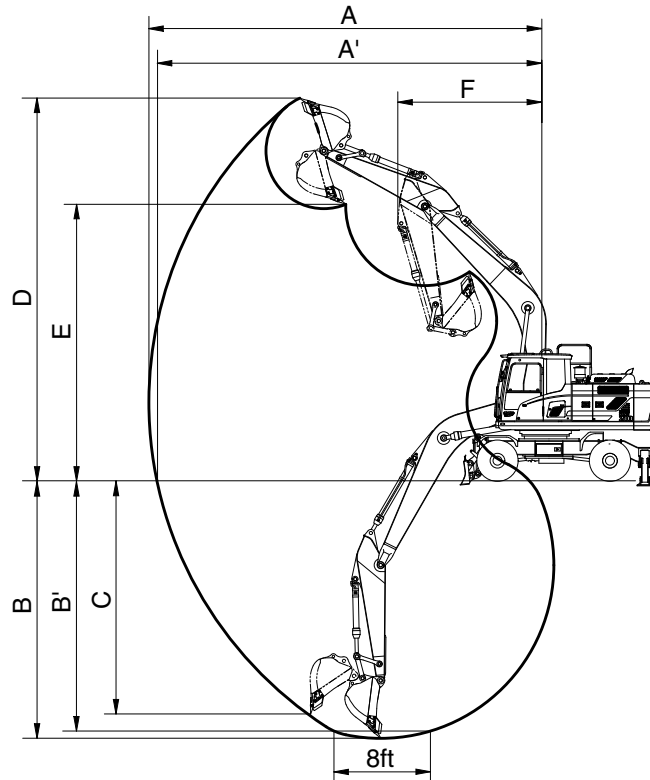

210WF2SP04

Description		2.0 m (6' 7") Arm	2.40 m (7' 10") Arm	2.92 m (9' 7") Arm
Max digging reach	A	9110 mm (29' 11")	9480 mm (31' 1")	9960 mm (32' 8")
Max digging reach on ground	A'	8870 mm (29' 1")	9260 mm (30' 5")	9750 mm (32' 0")
Max digging depth	B	5480 mm (18' 0")	5880 mm (19' 3")	6380 mm (20' 11")
Max digging depth (8ft level)	B'	5240 mm (17' 2")	5670 mm (18' 7")	6210 mm (20' 4")
Max vertical wall digging depth	C	4970 mm (16' 4")	5470 mm (17' 11")	5810 mm (19' 1")
Max digging height	D	9500 mm (31' 2")	9730 mm (31' 11")	10000 mm (32' 10")
Max dumping height	E	6670 mm (21' 11")	6900 mm (22' 8")	7160 mm (23' 6")
Min swing radius	F	3700 mm (12' 2")	3620 mm (11' 11")	3580 mm (11' 9")
Bucket digging force	SAE	133.4 [144.8] kN	133.4 [144.8] kN	133.4 [144.8] kN
		13600 [14770] kgf	13600 [14770] kgf	13600 [14770] kgf
		29980 [32550] lbf	29980 [32550] lbf	29980 [32550] lbf
	ISO	152.0 [165.0] kN	152.0 [165.0] kN	152.0 [165.0] kN
		15500 [16830] kgf	15500 [16830] kgf	15500 [16830] kgf
		34170 [37100] lbf	34170 [37100] lbf	34170 [37100] lbf
Arm digging force	SAE	144.2 [156.5] kN	119.6 [129.9] kN	102.0 [110.7] kN
		14700 [15960] kgf	12200 [13250] kgf	10400 [11290] kgf
		32410 [35190] lbf	26900 [29210] lbf	22930 [24900] lbf
	ISO	151.0 [164.0] kN	125.5 [136.3] kN	106.9 [116.1] kN
		15400 [16720] kgf	12800 [13900] kgf	10900 [11830] kgf
		33950 [36860] lbf	28220 [30640] lbf	24030 [26090] lbf

[ ] : Power boost

## 2) 5.39 m (17' 8") 2-PIECE BOOM

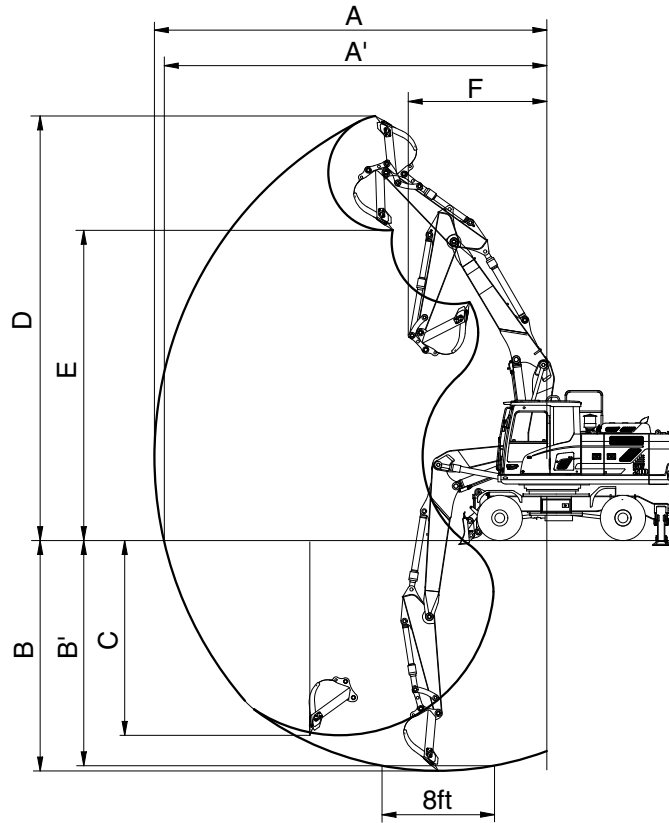

210WF2SP05

Description		2.0 m (6' 7") Arm	2.40 m (7' 10") Arm	2.92 m (9' 7") Arm
Max digging reach	A	8890 mm (29' 2")	9290 mm (30' 6")	9800 mm (32' 2")
Max digging reach on ground	A'	8670 mm (28' 5")	9080 mm (29' 9")	9600 mm (31' 6")
Max digging depth	B	5250 mm (17' 3")	5630 mm (18' 6")	6150 mm (20' 2")
Max digging depth (8ft level)	B'	5090 mm (16' 8")	5500 mm (18' 1")	6030 mm (19' 9")
Max vertical wall digging depth	C	4330 mm (14' 2")	4800 mm (15' 9")	5330 mm (17' 6")
Max digging height	D	9930 mm (32' 7")	10270 mm (33' 8")	10650 mm (34' 11")
Max dumping height	E	7020 mm (23' 0")	7350 mm (24' 1")	7730 mm (25' 4")
Min swing radius	F	3260 mm (10' 8")	2970 mm (9' 9")	2760 mm (9' 1")
Bucket digging force	SAE	133.4 [144.8] kN	133.4 [144.8] kN	133.4 [144.8] kN
		13600 [14770] kgf	13600 [14770] kgf	13600 [14770] kgf
		29980 [32550] lbf	29980 [32550] lbf	29980 [32550] lbf
	ISO	152.0 [165.0] kN	152.0 [165.0] kN	152.0 [165.0] kN
		15500 [16830] kgf	15500 [16830] kgf	15500 [16830] kgf
		34170 [37100] lbf	34170 [37100] lbf	34170 [37100] lbf
Arm digging force	SAE	144.2 [156.5] kN	119.6 [129.9] kN	102.0 [110.7] kN
		14700 [15960] kgf	12200 [13250] kgf	10400 [11290] kgf
		32410 [35190] lbf	26900 [29210] lbf	22930 [24900] lbf
	ISO	151.0 [164.0] kN	125.5 [136.3] kN	106.9 [116.1] kN
		15400 [16720] kgf	12800 [13900] kgf	10900 [11830] kgf
		33950 [36860] lbf	28220 [30640] lbf	24030 [26090] lbf

[ ] : Power boost











#### 4. WEIGHT

Item	kg	lb
Upperstructure assembly	8950	19730
Main frame weld assembly	1760	3880
Engine assembly	520	1150
Main pump assembly	136	300
Main control valve assembly	220	490
Swing motor assembly	254	560
Hydraulic oil tank weld assembly	165	360
Fuel tank weld assembly	170	375
Counterweight	3400	7500
Cab assembly	500	1100
Lower frame weld assembly	2450	5400
Swing bearing	285	630
Travel motor assembly	80	176
Turning joint	140	305
Transmission assembly	135	300
Front axle assembly	749	1651
Front wide axle assembly	770	1698
Rear axle assembly	592	1305
Rear wide axle assembly	623	1373
Front attachment assembly (5.65 m boom, 2.92 m arm, 0.87 m <sup>3</sup> SAE heaped bucket)	3895	8590
5.65 m boom assembly	1370	3020
2.7 m arm assembly	730	1609
0.87 m <sup>3</sup> SAE heaped bucket assembly	800	1764
Boom cylinder assembly	180/1EA	400/1EA
Arm cylinder assembly	290	640
Bucket cylinder assembly	175	390
Bucket control link assembly	170	370
Oscillating cylinder assembly	40/1EA	90/1EA
Dozer blade assembly	920	2030
Front outrigger assembly	390	860
Rear outrigger assembly	1020	2250
Outrigger cylinder assembly	100/1EA	220/1EA
Blade cylinder assembly	82/1EA	180/1EA

## 5. LIFTING CAPACITIES

### 1) MONO BOOM

(1) 5.65 m (18' 6") boom, 2.00 m (6' 7") arm equipped with 0.80 m<sup>3</sup> (SAE heaped) bucket and 4 outrigger down.

Load point height		Load radius								At max. reach		
		3.0 m (10 ft)		4.5 m (15 ft)		6.0 m (20 ft)		7.5 m (25 ft)		Capacity		Reach
												m (ft)
7.5 m (25 ft)	kg lb									*4060 *8950	*4060 *8950	6.85 (22.5)
6.0 m (20 ft)	kg lb					*4520 *9960	*4520 *9960			*4150 *9150	4120 9080	7.89 (25.9)
4.5 m (15 ft)	kg lb	*8830 *19470	*8830 *19470	*6030 *13290	*6030 *13290	*5030 *11090	*5030 *11090			*4300 *9480	3560 7850	8.48 (27.8)
3.0 m (10 ft)	kg lb			*7850 *17310	*7850 *17310	*5830 *12850	*5830 *12850	*4980 *10980	4260 9390	*4470 *9850	3330 7340	8.73 (28.6)
1.5 m (5 ft)	kg lb			*9310 *20530	*9310 *20530	*6610 *14570	5920 13050	*5330 *11750	4150 9150	*4680 *10320	3320 7320	8.67 (28.4)
Ground Line	kg lb			*9910 *21850	9210 20300	*7090 *15630	5770 12720			*4880 *10760	3550 7830	8.30 (27.2)
-1.5 m (-5 ft)	kg lb	*14170 *31240	*14170 *31240	*9750 *21500	9210 20300	*7100 *15650	5750 12680			*5040 *11110	4150 9150	7.57 (24.8)
-3.0 m (-10 ft)	kg lb	*12470 *27490	*12470 *27490	*8790 *19380	*8790 *19380					*4950 *10910	*4950 *10910	6.30 (20.7)

Note 1. Lifting capacity are based on SAE J1097 and ISO 10567.

2. Lifting capacity of the HX series does not exceed 75% of tipping load with the machine on firm, level ground or 87% of full hydraulic capacity.

3. The load point is a hook (standard equipment) located on the back of the bucket.

4. \*indicates load limited by hydraulic capacity.

※ Lifting capacities are based upon a standard machine conditions.

Lifting capacities will vary with different work tools, ground conditions and attachments.

The difference between the weight of a work tool attachment must be subtracted.











Consult your Hyundai dealer regarding the lifting capacities for specific work tools and attachments.

▲ Failure to comply to the rated load can cause possible personal injury or property damage.











Make adjustments to the rated load as necessary for non-standard configurations.















(2) 5.65 m (18' 6") boom, 2.00 m (6' 7") arm equipped with 0.80 m<sup>3</sup> (SAE heaped) bucket and 4 outrigger up.

Load point height		Load radius								At max. reach		
		3.0 m (10 ft)		4.5 m (15 ft)		6.0 m (20 ft)		7.5 m (25 ft)		Capacity		Reach
												m (ft)
7.5 m (25 ft)	kg lb									*4060 *8950	2680 5910	6.85 (22.5)
6.0 m (20 ft)	kg lb					*4520 *9960	3300 7280			3880 8550	1980 4370	7.89 (25.9)
4.5 m (15 ft)	kg lb	*8830 *19470	*8830 *19470	*6030 *13290	5030 11090	*5030 *11090	3140 6920			3360 7410	1640 3620	8.48 (27.8)
3.0 m (10 ft)	kg lb			*7850 *17310	4500 9920	5760 12700	2910 6420	4010 8840	1970 4340	3130 6900	1490 3280	8.73 (28.6)
1.5 m (5 ft)	kg lb			8670 19110	4110 9060	5530 12190	2710 5970	3900 8600	1880 4140	3120 6880	1470 3240	8.67 (28.4)
Ground Line	kg lb			8490 18720	3960 8730	5390 11880	2590 5710			3340 7360	1580 3480	8.30 (27.2)
-1.5 m (-5 ft)	kg lb	*14170 *31240	7580 16710	8490 18720	3960 8730	5370 11840	2570 5670			3900 8600	1900 4190	7.57 (24.8)
-3.0 m (-10 ft)	kg lb	*12470 *27490	7790 17170	8630 19030	4080 8990					*4950 *10910	2680 5910	6.30 (20.7)













(3) 5.65 m (18' 6") boom, 2.00 m (6' 7") arm equipped with 0.80 m<sup>3</sup> (SAE heaped) bucket, outrigger down and dozer blade down.

Load point height		Load radius								At max. reach		
		3.0 m (10 ft)		4.5 m (15 ft)		6.0 m (20 ft)		7.5 m (25 ft)		Capacity		Reach
												m (ft)
7.5 m (25 ft)	kg lb									*4090 *9020	*4090 *9020	6.85 (22.5)
6.0 m (20 ft)	kg lb					*4550 *10030	*4550 *10030			*4170 *9190	3400 7500	7.89 (25.9)
4.5 m (15 ft)	kg lb	*8890 *19600	*8890 *19600	*6070 *13380	*6070 *13380	*5060 *11160	*5060 *11160			*4310 *9500	2930 6460	8.48 (27.8)
3.0 m (10 ft)	kg lb			*7880 *17370	*7880 *17370	*5860 *12920	5040 11110	*4990 *11000	3490 7690	*4480 *9880	2720 6000	8.73 (28.6)
1.5 m (5 ft)	kg lb			*9330 *20570	7490 16510	*6630 *14620	4810 10600	*5340 *11770	3390 7470	*4680 *10320	2710 5970	8.67 (28.4)
Ground Line	kg lb			*9910 *21850	7310 16120	*7100 *15650	4680 10320			*4880 *10760	2890 6370	8.30 (27.2)
-1.5 m (-5 ft)	kg lb	*14120 *31130	*14120 *31130	*9740 *21470	7310 16120	*7090 *15630	4650 10250			*5020 *11070	3390 7470	7.57 (24.8)
-3.0 m (-10 ft)	kg lb	*12390 *27320	*12390 *27320	*8750 *19290	7450 16420					*4910 *10820	4650 10250	6.30 (20.7)













(4) 5.65 m (18' 6") boom, 2.00 m (6' 7") arm equipped with 0.80 m<sup>3</sup> (SAE heaped) bucket, outrigger up and dozer blade up.

Load point height		Load radius								At max. reach				
		3.0 m (10 ft)		4.5 m (15 ft)		6.0 m (20 ft)		7.5 m (25 ft)		Capacity		Reach		
														m (ft)
7.5 m (25 ft)	kg lb											*4090 *9020	2680 5910	6.85 (22.5)
6.0 m (20 ft)	kg lb					*4550 *10030	3300 7280					3880 8550	1980 4370	7.89 (25.9)
4.5 m (15 ft)	kg lb	*8890 *19600	*8890 *19600	*6070 *13380	5030 11090	*5060 *11160	3140 6920					3360 7410	1640 3620	8.48 (27.8)
3.0 m (10 ft)	kg lb			*7880 *17370	4500 9920	5760 12700	2910 6420	4010 8810	1970 4340			3130 6900	1490 3280	8.73 (28.6)
1.5 m (5 ft)	kg lb			8670 19110	4110 9060	5530 12190	2710 5970	3900 8600	1880 4140			3120 6880	1470 3240	8.67 (28.4)
Ground Line	kg lb			8490 18720	3960 8730	5390 11880	2590 5710					3340 7360	1580 3480	8.30 (27.2)
-1.5 m (-5 ft)	kg lb	*14120 *31130	7580 16710	8490 18720	3960 8730	5370 11840	2570 5670					3900 8600	1900 4190	7.57 (24.8)
-3.0 m (-10 ft)	kg lb	*12390 *27320	7790 17170	8630 19030	4080 8990							*4910 *10820	2680 5910	6.30 (20.7)













(5) 5.65 m (18' 6") boom, 2.40 m (7' 10") arm equipped with 0.80 m<sup>3</sup> (SAE heaped) bucket, 4-outrigger down.

Load point height		Load radius										At max. reach			
		1.5 m (5 ft)		3.0 m (10 ft)		4.5 m (15 ft)		6.0 m (20 ft)		7.5 m (25 ft)		Capacity		Reach	
														m (ft)	
7.5 m (25 ft)	kg lb												*3760 *8290	*3760 *8290	7.34 (24.1)
6.0 m (20 ft)	kg lb						*4100 *9040	*4100 *9040					*3860 *8510	3770 8310	8.31 (27.3)
4.5 m (15 ft)	kg lb					*5450 *12020	*5450 *12020	*4660 *10270	*4660 *10270	*4350 *9590	*4350 *9590	*4010 *8840	3290 7250	8.87 (29.1)	
3.0 m (10 ft)	kg lb					*7280 *16050	*7280 *16050	*5510 *12150	*5510 *12150	*4710 *10380	4260 9390	*4180 *9220	3090 6810	9.10 (29.9)	
1.5 m (5 ft)	kg lb					*8900 *19620	*8900 *19620	*6350 *14000	5920 13050	*5140 *11330	4140 9130	*4380 *9660	3070 6770	9.05 (29.7)	
Ground Line	kg lb			*9890 *21800	*9890 *21800	*9740 *21470	9180 20240	*6940 *15300	5740 12650	*5440 *11990	4050 8930	*4590 *10120	3260 7190	8.70 (28.5)	
-1.5 m (-5 ft)	kg lb	*10720 *23630	*10720 *23630	*14740 *32500	*14740 *32500	*9810 *21630	9130 20130	*7090 *15630	5690 12540			*4780 *10540	3750 8270	8.00 (26.2)	
-3.0 m (-10 ft)	kg lb	*15240 *33600	*15240 *33600	*13230 *29170	*13230 *29170	*9100 *20060	*9100 *20060	*6560 *14460	5760 12700			*4830 *10650	*4830 *10650	6.84 (22.4)	
-4.5 m (-15 ft)	kg lb			*10230 *22550	*10230 *22550	*7020 *15480	*7020 *15480								













(6) 5.65 m (18' 6") boom, 2.40 m (7' 10") arm equipped with 0.80 m<sup>3</sup> (SAE heaped) bucket, 4-outriger up.

Load point height		Load radius										At max. reach		
		1.5 m (5 ft)		3.0 m (10 ft)		4.5 m (15 ft)		6.0 m (20 ft)		7.5 m (25 ft)		Capacity		Reach
														m (ft)
7.5 m (25 ft)	kg lb											*3760 *8290	2360 5200	7.34 (24.1)
6.0 m (20 ft)	kg lb							*4100 *9040	3350 7390			3550 7830	1780 3920	8.31 (27.3)
4.5 m (15 ft)	kg lb					*5450 *12020	5130 11310	*4660 *10270	3170 6990	4120 9080	2080 4590	3100 6830	1490 3280	8.87 (29.1)
3.0 m (10 ft)	kg lb					*7280 *16050	4580 10100	*5510 *12150	2930 6460	4010 8840	1970 4340	2910 6420	1350 2980	9.10 (29.9)
1.5 m (5 ft)	kg lb					8710 19200	4140 9130	5530 12190	2710 5970	3890 8580	1860 4100	2890 6370	1330 2930	9.05 (29.7)
Ground Line	kg lb			*9890 *21800	7340 16180	8450 18630	3930 8660	5360 11820	2560 5640	3800 8380	1790 3950	3070 6770	1420 3130	8.70 (28.5)
-1.5 m (-5 ft)	kg lb	*10720 *23630	*10720 *23630	*14740 *32500	7410 16340	8410 18540	3890 8580	5310 11710	2510 5530			3530 7780	1680 3700	8.00 (26.2)
-3.0 m (-10 ft)	kg lb	*15240 *33600	*15240 *33600	*13230 *29170	7610 16780	8510 18760	3980 8770	5380 11860	2570 5670			4610 10160	2280 5030	6.84 (22.4)
-4.5 m (-15 ft)	kg lb			*10230 *22550	7990 17610	*7020 *15480	4240 9350							













(7) 5.65 m (18' 6") boom, 2.40 m (7' 10") arm equipped with 0.80 m<sup>3</sup> (SAE heaped) bucket, outrigger down and dozer blade down.

Load point height		Load radius										At max. reach		
		1.5 m (5 ft)		3.0 m (10 ft)		4.5 m (15 ft)		6.0 m (20 ft)		7.5 m (25 ft)		Capacity		Reach
														m (ft)
7.5 m (25 ft)	kg lb											*3760 *8290	*3760 *8290	7.34 (24.1)
6.0 m (20 ft)	kg lb							*4100 *9040	*4100 *9040			*3860 *8510	3110 6860	8.31 (27.3)
4.5 m (15 ft)	kg lb					*5450 *12020	*5450 *12070	*4660 *10270	*4660 *10270	*4350 *9590	3610 7960	*4010 *8840	2700 5950	8.87 (29.1)
3.0 m (10 ft)	kg lb					*7280 *16050	*7280 *16050	*5510 *12150	5060 11160	*4710 *10380	3490 7690	*4180 *9220	2520 5560	9.10 (29.9)
1.5 m (5 ft)	kg lb					*8900 *19620	7530 16600	*6350 *14000	4810 10600	*5140 *11330	3370 7430	*4380 *9660	2500 5510	9.05 (29.7)
Ground Line	kg lb			*9890 *21800	*9890 *21800	*9740 *21470	7280 16050	*6940 *15300	4650 10250	*5440 *11990	3290 7250	*4590 *10120	2650 5840	8.70 (28.5)
-1.5 m (-5 ft)	kg lb	*10720 *23630	*10720 *23630	*14740 *32500	*14740 *32500	*9810 *21630	7230 15940	*7090 *15630	4590 10120			*4780 *10540	3060 6750	8.00 (26.2)
-3.0 m (-10 ft)	kg lb	*15240 *33600	*15240 *33600	*13230 *29170	*13230 *29170	*9100 *20060	7340 16180	*6560 *14460	4670 10300			*4830 *10650	4020 8860	6.84 (22.4)
-4.5 m (-15 ft)	kg lb			*10230 *22550	*10230 *22550	*7020 *15480	*7020 *15480							













(8) 5.65 m (18' 6") boom, 2.40 m (7' 10") arm equipped with 0.80 m<sup>3</sup> (SAE heaped) bucket, outrigger up and dozer blade up.

Load point height		Load radius										At max. reach		
		1.5 m (5 ft)		3.0 m (10 ft)		4.5 m (15 ft)		6.0 m (20 ft)		7.5 m (25 ft)		Capacity		Reach
														m (ft)
7.5 m (25 ft)	kg lb											*3760 *8290	2360 5200	7.34 (24.1)
6.0 m (20 ft)	kg lb							*4100 *9040	3350 7390			3550 7830	1780 3920	8.31 (27.3)
4.5 m (15 ft)	kg lb					*5450 *12020	5130 11310	*4660 *10270	3170 6990	4120 9080	2080 4590	3100 6830	1490 3280	8.87 (29.1)
3.0 m (10 ft)	kg lb					*7280 *16050	4580 10100	*5510 *12150	2930 6460	4010 8840	1970 4340	2910 6420	1350 2980	9.10 (29.9)
1.5 m (5 ft)	kg lb					8710 19200	4140 9130	5530 12190	2710 5970	3890 8580	1860 4100	2890 6370	1330 2930	9.05 (29.7)
Ground Line	kg lb			*9890 *21800	7340 16180	8450 18630	3930 8660	5360 11820	2560 5640	3800 8380	1790 3950	3070 6770	1420 3130	8.70 (28.5)
-1.5 m (-5 ft)	kg lb	*10720 *23630	*10720 *23630	*14740 *32500	7410 16340	8410 18540	3890 8580	5310 11710	2510 5530			3530 7780	1680 3700	8.00 (26.2)
-3.0 m (-10 ft)	kg lb	*15240 *33600	*15240 *33600	*13230 *29170	7610 16780	8510 18760	3980 8770	5380 11860	2570 5670			4610 10160	2280 5030	6.84 (22.4)
-4.5 m (-15 ft)	kg lb			*10230 *22550	7990 17610	*7020 *15480	4240 9350							













(9) 5.65 m (18' 6") boom, 2.92 m (9' 7") arm equipped with 0.80 m<sup>3</sup> (SAE heaped) bucket, 4-outrigger down.

Load point height		Load radius										At max. reach		
		1.5 m (5 ft)		3.0 m (10 ft)		4.5 m (15 ft)		6.0 m (20 ft)		7.5 m (25 ft)		Capacity		Reach
														m (ft)
9.0m (30 ft)	kg lb											*3350 *7390	*3350 *7390	6.52 (21.4)
7.5 m (25 ft)	kg lb											*3400 *7500	*3400 *7500	7.96 (26.1)
6.0 m (20 ft)	kg lb									*2360 *5800	*2360 *5800	*3510 *7740	3370 7430	8.85 (29.0)
4.5 m (15 ft)	kg lb							*4140 *9130	*4140 *9130	*3920 *8640	*3920 *8640	*3650 *8050	2970 6550	9.37 (30.7)
3.0 m (10 ft)	kg lb			*10640 *23460	*10640 *23460	*6480 *14290	*6480 *14290	*5020 *11070	*5020 *11070	*4350 *9590	4260 9390	*3820 *8420	2790 6150	9.59 (31.5)
1.5 m (5 ft)	kg lb			*8960 *19750	*8960 *19750	*8280 *18250	*8280 *18250	*5950 *13120	5910 13030	*4840 *10670	4110 9060	*4010 *8840	2770 6110	9.54 (31.3)
Ground Line	kg lb			*10270 *22640	*10270 *22640	*9290 *20700	9130 20130	*6660 *14680	5690 12540	*5240 *11550	3990 8800	*4220 *9300	2920 6440	9.21 (30.2)
-1.5 m (-5 ft)	kg lb	*9530 *21010	*9530 *21010	*13530 *29830	*13530 *29830	*9740 *21470	9000 19840	*6990 *15410	5590 12320	*5370 *11840	3950 8710	*4430 *9770	3300 7280	8.56 (28.1)
-3.0 m (-10 ft)	kg lb	*12990 *28640	*12990 *28640	*13990 *30840	*13990 *30840	*9350 *20610	9050 19950	*6760 *14900	5620 12390			*4570 *10080	4140 9130	7.50 (24.6)
-4.5 m (-15 ft)	kg lb			*11590 *25550	*11590 *25550	*7910 *17440	*7910 *17440							













(10) 5.65 m (18' 6") boom, 2.92 m (9' 7") arm equipped with 0.80 m<sup>3</sup> (SAE heaped) bucket, 4-outtrigger up.

Load point height		Load radius										At max. reach		
		1.5 m (5 ft)		3.0 m (10 ft)		4.5 m (15 ft)		6.0 m (20 ft)		7.5 m (25 ft)		Capacity		Reach
														m (ft)
9.0 m (30 ft)	kg lb											*3350 *7390	3040 6700	6.52 (21.4)
7.5 m (25 ft)	kg lb											*3400 *7500	2010 4430	7.96 (26.1)
6.0 m (20 ft)	kg lb								*2630 *5800	2160 4760		3170 6990	1540 3400	8.85 (29.0)
4.5 m (15 ft)	kg lb						*4140 *9130	3210 7080	*3920 *8640	2090 4610		2800 6170	1300 2870	9.37 (30.7)
3.0 m (10 ft)	kg lb			*10640 *23460	8580 18920	*6480 *14290	4680 10320	*5020 *11070	2950 6500	4010 8840	1960 4320	2630 5800	1180 2600	9.59 (31.5)
1.5 m (5 ft)	kg lb			*8960 *19750	7420 16360	*8280 *18250	4170 9190	5520 12170	2690 5930	3860 8510	1830 4030	2610 5750	1150 2540	9.54 (31.3)
Ground Line	kg lb			*10270 *22640	7170 15810	8400 18520	3870 8530	5310 11710	2500 5510	3740 8250	1730 3810	2740 6040	1220 2690	9.21 (30.2)
-1.5 m (-5 ft)	kg lb	*9530 *21010	*9530 *21010	*13530 *29830	7180 15830	8280 18250	3770 8310	5210 11490	2420 5340	3700 8160	1680 3700	3100 6830	1410 3110	8.56 (28.1)
-3.0 m (-10 ft)	kg lb	*12990 *28640	*12990 *28640	*13990 *30840	7340 16180	8340 18390	3820 8420	5240 11550	2440 5380			3890 8580	1860 4100	7.50 (24.6)
-4.5 m (-15 ft)	kg lb			*11590 *25550	7660 16890	*7910 *17440	4000 8820							

(11) 5.65 m (18' 6") boom, 2.92 m (9' 7") arm equipped with 0.80 m<sup>3</sup> (SAE heaped) bucket, outrigger down and dozer blade down.











Load point height		Load radius										At max. reach		
		1.5 m (5 ft)		3.0 m (10 ft)		4.5 m (15 ft)		6.0 m (20 ft)		7.5 m (25 ft)		Capacity		Reach
														m (ft)
9.0 m (30 ft)	kg lb											*3350 *7390	*3350 *7390	6.52 (21.4)
7.5 m (25 ft)	kg lb											*3400 *7500	*3400 *7500	7.96 (26.1)
6.0 m (20 ft)	kg lb									*2630 *5800	*2630 *5800	*3510 *7740	2760 6080	8.85 (29.0)
4.5 m (15 ft)	kg lb							*4140 *9130	*4140 *9130	*3920 *8640	3630 8000	*3650 *8050	2420 5340	9.37 (30.7)
3.0 m (10 ft)	kg lb			*10640 *23460	*10640 *23460	*6480 *14290	*6480 *14290	*5020 *11070	*5020 *11070	*4350 *9590	3490 7690	*3820 *8420	2260 4980	9.59 (31.5)
1.5 m (5 ft)	kg lb			*8960 *19750	*8960 *19750	*8280 *18250	7570 16690	*5950 *13120	4800 10580	*4840 *10670	3340 7360	*4010 *8840	2240 4940	9.54 (31.3)
Ground Line	kg lb			*10270 *22640	*10270 *22640	*9390 *20700	7230 15940	*6660 *14680	4600 10140	*5240 *11550	3230 7120	*4220 *9300	2360 5200	9.21 (30.2)
-1.5 m (-5 ft)	kg lb	*9530 *21010	*9530 *21010	*13530 *29830	*13530 *29830	*9740 *21470	7110 15670	*6990 *15410	4500 9920	*5370 *14840	3190 7030	*4430 *9770	2670 5890	8.56 (28.1)
-3.0 m (-10 ft)	kg lb	*12990 *28640	*12990 *28640	*13990 *30840	*13990 *30840	*9350 *20610	7160 15790	*6760 *14900	4520 9960			*4570 *10080	3380 7450	7.50 (24.6)
-4.5 m (-15 ft)	kg lb			*11590 *25550	*11590 *25550	*7910 *17440	7380 16270							

(12) 5.65 m (18' 6") boom, 2.92 m (9' 7") arm equipped with 0.80 m<sup>3</sup> (SAE heaped) bucket, outrigger up and dozer blade up.











Load point height		Load radius										At max. reach		
		1.5 m (5 ft)		3.0 m (10 ft)		4.5 m (15 ft)		6.0 m (20 ft)		7.5 m (25 ft)		Capacity		Reach
														m (ft)
9.0 m (30 ft)	kg lb											*3350 *7390	3040 6700	6.52 (21.4)
7.5 m (25 ft)	kg lb											*3400 *7500	2010 4430	7.96 (26.1)
6.0 m (20 ft)	kg lb									*2630 *5800	2160 4760	3170 6990	1540 3400	8.85 (29.0)
4.5 m (15 ft)	kg lb							*4140 *9130	3210 7080	*3920 *8640	2090 4610	2800 6170	1300 2870	9.37 (30.7)
3.0 m (10 ft)	kg lb			*10640 *23460	8580 18920	*6480 *14290	4680 10320	*5020 *11070	2950 6500	4010 8840	1960 4320	2630 5800	1180 2600	9.59 (31.5)
1.5 m (5 ft)	kg lb			*8960 *19750	7420 16360	*8280 *18250	4170 9190	5520 12170	2690 5930	3860 8510	1830 4030	2610 5750	1150 2540	9.54 (31.3)
Ground Line	kg lb			*10270 *22640	7170 15810	8400 18520	3870 8530	5310 11710	2500 5510	3740 8250	1730 3810	2740 6040	1220 2690	9.21 (30.2)
-1.5 m (-5 ft)	kg lb	*9530 *21010	*9530 *21010	*13530 *29830	7180 15830	8280 18250	3770 8310	5210 11490	2420 5340	3700 8160	1680 3700	3100 6830	1410 3110	8.56 (28.1)
-3.0 m (-10 ft)	kg lb	*12990 *28640	*12990 *28640	*13990 *30840	7340 16180	8340 18390	3820 8420	5240 11550	2440 5380			3890 8580	1860 4100	7.50 (24.6)
-4.5 m (-15 ft)	kg lb			*11590 *25550	7660 16890	*7910 *17440	4000 8820							

## 2) ADJUST BOOM











(1) 5.39 m (17' 8") boom, 2.00 m (6' 7") arm equipped with 0.80 m<sup>3</sup> (SAE heaped) bucket, 4-outrigger down.

Load point height		Load radius								At max. reach		
		3.0 m (10 ft)		4.5 m (15 ft)		6.0 m (20 ft)		7.5 m (25 ft)		Capacity		Reach
												m (ft)
9.0m (30 ft)	kg lb									*3890 *8580	*3890 *8580	4.39 (14.4)
7.5 m (25 ft)	kg lb			*3980 *8770	*3980 *8770					*3660 *8070	*3660 *8070	6.49 (21.3)
6.0 m (20 ft)	kg lb			*4080 *8990	*4080 *8990	*4000 *8820	*4000 *8820			*3690 *8140	*3690 *8140	7.61 (25.0)
4.5 m (15 ft)	kg lb	*6860 *15120	*6860 *15120	*5020 *11070	*5020 *11070	*4320 *9520	*4320 *9520			*3800 *8380	3800 8380	8.25 (27.1)
3.0 m (10 ft)	kg lb			*6510 *14350	*6510 *14350	*4960 *10930	*4960 *10930	*4340 *9570	4330 9550	*3960 *8730	3520 7760	8.53 (28.0)
1.5 m (5 ft)	kg lb			*7880 *17370	*7880 *17370	*5650 *12460	*5650 *12460	*4640 *10230	4240 9350	*4160 *9170	3510 7740	8.49 (27.9)
Ground Line	kg lb			*8620 *19000	*8620 *19000	*6150 *13560	5910 13030			*4370 *9630	3740 8250	8.13 (26.7)
-1.5 m (-5 ft)	kg lb	*12970 *28590	*12970 *28590	*8660 *19090	*8660 *19090	*6230 *13730	5880 12960					











(2) 5.39 m (17' 8") boom, 2.00 m (6' 7") arm equipped with 0.80 m<sup>3</sup> (SAE heaped) bucket, 4-outrigger up.

Load point height		Load radius								At max. reach		
		3.0 m (10 ft)		4.5 m (15 ft)		6.0 m (20 ft)		7.5 m (25 ft)		Capacity		Reach
												m (ft)
9.0m (30 ft)	kg lb									*3890 *8580	*3890 *8580	4.39 (14.4)
7.5 m (25 ft)	kg lb			*3980 *8770	*3980 *8770					*3660 *8070	2990 6590	6.49 (21.3)
6.0 m (20 ft)	kg lb			*4080 *8990	*4080 *8990	*4000 *8820	3330 7340			*3690 *8140	2150 4740	7.61 (25.0)
4.5 m (15 ft)	kg lb	*6860 *15120	*6860 *15120	*5020 *11070	*5020 *11070	*4320 *9520	3210 7080			3580 7890	1770 3900	8.25 (27.1)
3.0 m (10 ft)	kg lb			*6510 *14350	4680 10320	*4960 *10930	3000 6610	4070 8970	2010 4430	3320 7320	1600 3530	8.53 (28.0)
1.5 m (5 ft)	kg lb			*7880 *17370	4270 9410	*5650 *12460	2800 6170	3980 8770	1930 4250	3300 7280	1570 3460	8.49 (27.9)
Ground Line	kg lb			*8620 *19000	4080 8990	5520 12170	2670 5890			3520 7760	1690 3730	8.13 (26.7)
-1.5 m (-5 ft)	kg lb	*12970 *28590	7700 16980	8650 19070	4060 8950	5490 12100	2640 5820					

(3) 5.39 m (17' 8") boom, 2.00 m (6' 7") arm equipped with 0.80 m<sup>3</sup> (SAE heaped) bucket, outrigger down and dozer blade down.











Load point height		Load radius								At max. reach		
		3.0 m (10 ft)		4.5 m (15 ft)		6.0 m (20 ft)		7.5 m (25 ft)		Capacity		Reach
												m (ft)
9.0m (30 ft)	kg lb									*3900 *8600	*3900 *8600	4.40 (14.4)
7.5 m (25 ft)	kg lb			*3980 *8770	*3980 *8770					*3660 *8070	*3660 *8070	6.49 (21.3)
6.0 m (20 ft)	kg lb			*4070 *8970	*4070 *8970	*4000 *8820	*4000 *8820			*3690 *8140	3670 8090	7.62 (25.0)
4.5 m (15 ft)	kg lb	*6850 *15100	*6850 *15100	*5020 *11070	*5020 *11070	*4320 *9520	*4320 *9520			*3800 *8380	3120 6880	8.25 (27.1)
3.0 m (10 ft)	kg lb			*6510 *14350	*6510 *14350	*4960 *10930	*4960 *10930	*4340 *9570	3550 7830	*3960 *8730	2880 6350	8.53 (28.0)
1.5 m (5 ft)	kg lb			*7880 *17370	7710 17000	*5650 *12460	4940 10890	*4640 *10230	3470 7650	*4160 *9170	2860 6310	8.50 (27.9)
Ground Line	kg lb			*8620 *19000	7490 16510	*6150 *13560	4790 10560			*4360 *9610	3060 6750	8.14 (26.7)
-1.5 m (-5 ft)	kg lb	*12970 *28590	*12970 *28590	*8660 *19000	7470 16470	*6240 *13760	4760 10490					

(4) 5.39 m (17' 8") boom, 2.00 m (6' 7") arm equipped with 0.80 m<sup>3</sup> (SAE heaped) bucket, outrigger up and dozer blade up.











Load point height		Load radius								At max. reach		
		3.0 m (10 ft)		4.5 m (15 ft)		6.0 m (20 ft)		7.5 m (25 ft)		Capacity		Reach
												m (ft)
9.0m (30 ft)	kg lb									*3890 *8580	*3890 *8580	4.39 (14.4)
7.5 m (25 ft)	kg lb			*3980 *8770	*3980 *8770					*3660 *8070	2990 6590	6.49 (21.3)
6.0 m (20 ft)	kg lb			*4080 *8990	*4080 *8990	*4000 *8820	3330 7340			*3690 *8140	2150 4740	7.61 (25.0)
4.5 m (15 ft)	kg lb	*6860 *15120	*6860 *15120	*5020 *11070	*5020 *11070	*4320 *9520	3210 7080			3580 7890	1770 3900	8.25 (27.1)
3.0 m (10 ft)	kg lb			*6510 *14350	4680 10320	*4960 *10930	3000 6610	4070 8970	2010 4430	3320 7320	1600 3530	8.53 (28.0)
1.5 m (5 ft)	kg lb			*7880 *17370	4270 9410	*5650 *12460	2800 6170	3980 8770	1930 4250	3300 7280	1570 3460	8.49 (27.9)
Ground Line	kg lb			*8620 *19000	4080 8990	5520 12170	2670 5890			3520 7760	1690 3730	8.13 (26.7)
-1.5 m (-5 ft)	kg lb	*12970 *28590	7700 16980	8650 19070	4060 8950	5490 12100	2640 5820					













(5) 5.39 m (17' 8") boom, 2.40 m (7' 10") arm equipped with 0.80 m<sup>3</sup> (SAE heaped) bucket, 4-outrigger down.

Load point height		Load radius								At max. reach		
		3.0 m (10 ft)		4.5 m (15 ft)		6.0 m (20 ft)		7.5 m (25 ft)		Capacity		Reach
												m (ft)
9.0 m (30 ft)	kg lb									*3480 *7670	*3480 *7670	5.19 (17.0)
7.5 m (25 ft)	kg lb									*3370 *7430	*3370 *7430	7.00 (23.0)
6.0 m (20 ft)	kg lb					*3600 *7940	*3600 *7940			*3420 *7540	*3420 *7540	8.04 (26.4)
4.5 m (15 ft)	kg lb			*4520 *9960	*4520 *9960	*3980 *8770	*3980 *8770	*3700 *8160	*3700 *8160	*3530 *7780	3500 7720	8.64 (28.3)
3.0 m (10 ft)	kg lb	*10000 *22050	*10000 *22050	*6010 *13250	*6010 *13250	*4660 *10270	*4660 *10270	*4070 *8970	*4070 *8970	*3690 *8140	3260 7190	8.91 (29.2)
1.5 m (5 ft)	kg lb			*7490 *16510	*7490 *16510	*5400 *11900	*5400 *11900	*4430 *9770	4230 9330	*3880 *8550	3240 7140	8.87 (29.1)
Ground Line	kg lb	*10060 *22180	*10060 *22180	*8410 *18540	*8410 *18540	*5980 *13180	*5880 12960	*4720 *10410	4140 9130	*4090 *9020	3440 7580	8.54 (28.0)
-1.5 m (-5 ft)	kg lb	*13330 *29390	*13330 *29390	*8650 *19070	*8650 *19070	*6200 *13670	5820 12830			*4270 *9410	3960 8730	7.85 (25.8)
-3.0 m (-10 ft)	kg lb			*8130 *17920	*8130 *17920	*5760 *12700	*5760 *12700					











(6) 5.39 m (17' 8") boom, 2.40 m (7' 10") arm equipped with 0.80 m<sup>3</sup> (SAE heaped) bucket, 4-outrigger up.

Load point height		Load radius								At max. reach		
		3.0 m (10 ft)		4.5 m (15 ft)		6.0 m (20 ft)		7.5 m (25 ft)		Capacity		Reach
												m (ft)
9.0 m (30 ft)	kg lb									*3480 *7670	*3480 *7670	5.19 (17.0)
7.5 m (25 ft)	kg lb									*3370 *7430	2600 5730	7.00 (23.0)
6.0 m (20 ft)	kg lb					*3600 *7940	3390 7470			*3420 *7540	1930 4250	8.04 (26.4)
4.5 m (15 ft)	kg lb			*4520 *9960	*4520 *9960	*3980 *8770	3240 7140	*3700 *8160	2100 4630	3300 7280	1600 3530	8.64 (28.3)
3.0 m (10 ft)	kg lb	*10000 *22050	8610 18980	*6010 *13250	4760 10490	*4660 *10270	3020 6660	*4070 *8970	2020 4450	3070 6770	1450 3200	8.91 (29.2)
1.5 m (5 ft)	kg lb			*7490 *16510	4300 9480	*5400 *11900	2800 6170	3970 8750	1920 4230	3050 6720	1420 3130	8.87 (29.1)
Ground Line	kg lb	*10060 *22180	7490 16510	*8410 *18540	4050 8930	5490 12100	2640 5820	3890 8580	1840 4060	3230 7120	1520 3350	8.54 (28.0)
-1.5 m (-5 ft)	kg lb	*13330 *29390	7550 16640	8580 18920	3990 8800	5430 11970	2580 5690			3720 8200	1790 3950	7.85 (25.8)
-3.0 m (-10 ft)	kg lb			*8130 *17920	4070 8970	5510 12150	2560 5860					











(7) 5.39 m (17' 8") boom, 2.40 m (7' 10") arm equipped with 0.80 m<sup>3</sup> (SAE heaped) bucket, outrigger down and dozer blade down.

Load point height		Load radius								At max. reach		
		3.0 m (10 ft)		4.5 m (15 ft)		6.0 m (20 ft)		7.5 m (25 ft)		Capacity		Reach
												m (ft)
9.0m (30 ft)	kg lb									*3480 *7670	*3480 *7670	5.19 (17.0)
7.5 m (25 ft)	kg lb									*3370 *7430	*3370 *7430	7.00 (23.0)
6.0 m (20 ft)	kg lb					*3600 *7940	*3600 *7940			*3420 *7540	3340 7360	8.04 (26.4)
4.5 m (15 ft)	kg lb			*4520 *9960	*4520 *9960	*3980 *8770	*3980 *8770	*3700 *8160	3650 8050	*3530 *7780	2870 6330	8.64 (28.3)
3.0 m (10 ft)	kg lb	*10000 *22050	*10000 *22050	*6010 *13250	*6010 *13250	*4660 *10270	*4660 *10270	*4070 *8970	3560 7850	*3690 *8140	2660 5860	8.91 (29.2)
1.5 m (5 ft)	kg lb			*7490 *16510	*7490 *16510	*5400 *11900	4940 10890	*4430 *9770	3450 7610	*3880 *8550	2640 5820	8.87 (29.1)
Ground Line	kg lb	*10060 *22180	*10060 *22180	*8410 *18540	7470 16470	*5980 *13180	4770 10520	*4720 *10410	3370 7430	*4090 *9020	2800 6170	8.54 (28.0)
-1.5 m (-5 ft)	kg lb	*13330 *29390	*13330 *29390	*8650 *19070	7390 16290	*6200 *13670	4700 10360			*4270 *9410	3230 7120	7.85 (25.8)
-3.0 m (-10 ft)	kg lb			*8130 *17920	7490 16510	*5760 *12700	4780 10540					











(8) 5.39 m (17' 8") boom, 2.40 m (7' 10") arm equipped with 0.80 m<sup>3</sup> (SAE heaped) bucket, outrigger up and dozer blade up.

Load point height		Load radius								At max. reach		
		3.0 m (10 ft)		4.5 m (15 ft)		6.0 m (20 ft)		7.5 m (25 ft)		Capacity		Reach
												m (ft)
9.0m (30 ft)	kg lb									*3480 *7670	*3480 *7670	5.19 (17.0)
7.5 m (25 ft)	kg lb									*3370 *7430	2600 5730	7.00 (23.0)
6.0 m (20 ft)	kg lb					*3600 *7940	3390 7470			*3420 *7540	1930 4250	8.04 (26.4)
4.5 m (15 ft)	kg lb			*4520 *9960	*4520 *9960	*3980 *8770	3240 7140	*3700 *8160	2100 4360	3300 7280	1600 3530	8.64 (28.3)
3.0 m (10 ft)	kg lb	*10000 *22050	8610 18980	*6010 *13250	4760 10490	*4660 *10270	3020 6660	*4070 *8970	2020 4450	3070 6770	1450 3200	8.91 (29.2)
1.5 m (5 ft)	kg lb			*7490 *16510	4300 9480	*5400 *11900	2800 6170	3970 8750	1920 4230	3050 6720	1420 3130	8.87 (29.1)
Ground Line	kg lb	*10060 *22180	7490 16510	*8410 *18540	4050 8930	5490 12100	2640 5820	*3890 *8580	1840 4060	3230 7120	1520 3350	8.54 (28.0)
-1.5 m (-5 ft)	kg lb	*13330 *29390	7550 16640	8580 18920	3990 8800	5430 11970	2580 5690			3720 8200	1790 3950	7.85 (25.8)
-3.0 m (-10 ft)	kg lb			*8130 *17920	4070 8970	5510 12150	2660 5860					











(9) 5.39 m (17' 8") boom, 2.92 m (9' 7") arm equipped with 0.80 m<sup>3</sup> (SAE heaped) bucket, 4-outrigger down.

Load point height		Load radius								At max. reach		
		3.0 m (10 ft)		4.5 m (15 ft)		6.0 m (20 ft)		7.5 m (25 ft)		Capacity		Reach
												m (ft)
9.0 m (30 ft)	kg lb									*3060 *6750	*3060 *6750	6.09 (20.0)
7.5 m (25 ft)	kg lb					*3150 *6940	*3150 *6940			*3030 *6680	*3030 *6680	7.65 (25.1)
6.0 m (20 ft)	kg lb					*3090 *6810	*3090 *6810			*3090 *6810	*3090 *6810	8.60 (28.2)
4.5 m (15 ft)	kg lb			*3820 *8420	*3820 *8420	*3500 *7720	*3500 *7720	*3390 *7470	*3390 *7470	*3200 *7050	3150 6940	9.15 (30.0)
3.0 m (10 ft)	kg lb	*8220 *18120	*8220 *18120	*5300 *11680	*5300 *11680	*4210 *9280	*4210 *9280	*3710 *8180	*3710 *8180	*3350 *7390	2950 6500	9.40 (30.8)
1.5 m (5 ft)	kg lb	*10330 *22770	*10330 *22770	*6890 *15190	*6890 *15190	*5020 *11070	*5020 *11070	*4140 *9130	*4140 *9130	*3530 *7780	2920 6440	9.37 (30.7)
Ground Line	kg lb	*10560 *23280	*10560 *23280	*8020 *17680	*8020 *17680	*5700 *12570	*5700 *12570	*4510 *9940	4090 9020	*3730 *8220	3070 6770	9.06 (29.7)
-1.5 m (-5 ft)	kg lb	*13510 *29780	*13510 *29780	*8510 *18760	*8510 *18760	*6070 *13380	5780 12630	*4670 *10300	4050 8930	*3930 *8660	3470 7650	8.42 (27.6)
-3.0 m (-10 ft)	kg lb	*12660 *27910	*12660 *27910	*8310 *18320	*8310 *18320	*5940 *13100	5750 12680					











(10) 5.39 m (17' 8") boom, 2.92 m (9' 7") arm equipped with 0.80 m<sup>3</sup> (SAE heaped) bucket, 4-outrigger up.

Load point height		Load radius								At max. reach		
		3.0 m (10 ft)		4.5 m (15 ft)		6.0 m (20 ft)		7.5 m (25 ft)		Capacity		Reach
												m (ft)
9.0 m (30 ft)	kg lb									*3060 *6750	*3060 *6750	6.09 (20.0)
7.5 m (25 ft)	kg lb					*3150 *6940	*3150 *6940			*3030 *6680	2200 4850	7.65 (25.1)
6.0 m (20 ft)	kg lb					*3090 *6810	*3090 *6810			*3090 *6810	1670 3680	8.60 (28.2)
4.5 m (15 ft)	kg lb			*3820 *8420	*3820 *8420	*3500 *7720	3290 7250	*3390 *7470	2130 4700	2960 6530	1390 3060	9.15 (30.0)
3.0 m (10 ft)	kg lb	*8220 *18120	*8220 *18120	*5300 *11680	4860 10710	*4210 *9280	3040 6700	*3710 *8180	2010 4430	2770 6110	1260 2780	9.40 (30.8)
1.5 m (5 ft)	kg lb	*10330 *22770	7790 17170	*6890 *15190	4340 9570	*5020 *11070	2780 6130	3940 8690	1890 4170	2740 6040	1230 2710	9.37 (30.7)
Ground Line	kg lb	*10560 *23280	7370 16250	*8020 *17680	4010 8840	5440 11990	2590 5710	3830 8440	1780 3920	2880 6350	1300 2870	9.06 (29.7)
-1.5 m (-5 ft)	kg lb	*13510 *29780	7340 16180	8470 18670	3880 8550	5340 11770	2500 5510	3790 8360	1750 3860	3260 7190	1510 3330	8.42 (27.6)
-3.0 m (-10 ft)	kg lb	*12660 *27910	7480 16490	*8310 *18320	3910 8620	5360 11820	2520 5560					

(11) 5.39 m (17' 8") boom, 2.92 m (9' 7") arm equipped with 0.80 m<sup>3</sup> (SAE heaped) bucket, outrigger down and dozer blade down.

Load point height		Load radius								At max. reach		
		3.0 m (10 ft)		4.5 m (15 ft)		6.0 m (20 ft)		7.5 m (25 ft)		Capacity		Reach
												m (ft)
9.0 m (30 ft)	kg lb									*3060 *6750	*3060 *6750	6.09 (20.0)
7.5 m (25 ft)	kg lb					*3150 *6940	*3150 *6940			*3030 *6680	*3030 *6680	7.65 (25.1)
6.0 m (20 ft)	kg lb					*3090 *6810	*3090 *6810			*3090 *6810	2950 6500	8.60 (28.2)
4.5 m (15 ft)	kg lb			*3820 *8420	*3820 *8420	*3500 *7720	*3500 *7720	*3390 *7470	*3390 *7470	*3200 *7050	2570 5670	9.15 (30.0)
3.0 m (10 ft)	kg lb	*8220 *18120	*8220 *18120	*5300 *11680	*5300 *11680	*4210 *9280	*4210 *9280	*3710 *8180	3570 7870	*3350 *7390	2390 5270	9.40 (30.8)
1.5 m (5 ft)	kg lb	*10330 *22770	*10330 *22770	*6890 *15190	*6890 *15190	*5020 *11070	4930 10870	*4140 *9130	3430 7560	*3530 *7780	2360 5200	9.37 (30.7)
Ground Line	kg lb	*10560 *23280	*10560 *23280	*8020 *17680	7430 16380	*5700 *12570	4720 10410	*4510 *9940	3320 7320	*3730 *8220	2490 5490	9.06 (29.7)
-1.5 m (-5 ft)	kg lb	*13510 *29780	*13510 *29780	*8510 *18760	7280 16050	*6070 *13380	4610 10160	*4670 *10300	3270 7210	*3930 *8660	2820 6220	8.42 (27.6)
-3.0 m (-10 ft)	kg lb	*12660 *27910	*12660 *27910	*8310 *18320	7320 16140	*5940 *13100	4640 10230					

(12) 5.39 m (17' 8") boom, 2.92 m (9' 7") arm equipped with 0.80 m<sup>3</sup> (SAE heaped) bucket, outrigger up and dozer blade up.

Load point height		Load radius								At max. reach		
		3.0 m (10 ft)		4.5 m (15 ft)		6.0 m (20 ft)		7.5 m (25 ft)		Capacity		Reach
												m (ft)
9.0 m (30 ft)	kg lb									*3060 *6750	*3060 *6750	6.09 (20.0)
7.5 m (25 ft)	kg lb					*3150 *6940	*3150 *6940			*3030 *6680	2200 4850	7.65 (25.1)
6.0 m (20 ft)	kg lb					*3090 *6810	*3090 *6810			*3090 *6810	1670 3680	8.60 (28.2)
4.5 m (15 ft)	kg lb			*3820 *8420	*3820 *8420	*3500 *7720	3290 7250	*3390 *7470	2130 4700	2960 6530	1390 3060	9.15 (30.0)
3.0 m (10 ft)	kg lb	*8220 *18120	*8220 *18120	*5300 *11680	4860 10710	*4210 *9280	3040 6700	*3710 *8180	2010 4430	2770 6110	1260 2780	9.40 (30.8)
1.5 m (5 ft)	kg lb	*10330 *22770	7790 17170	*6890 *15190	4340 9570	*5020 *11070	2780 6130	3940 8690	1890 4170	2740 6040	1230 2710	9.37 (30.7)
Ground Line	kg lb	*10560 *23280	7370 16250	*8020 *17680	4010 8840	5440 11990	2590 5710	3830 8440	1780 3920	2880 6350	1300 2870	9.06 (29.7)
-1.5 m (-5 ft)	kg lb	*13510 *29780	7340 16180	8470 18670	3880 8550	5340 11770	2500 5510	3790 8360	1750 3860	3260 7190	1510 3330	8.42 (27.6)
-3.0 m (-10 ft)	kg lb	*12660 *27910	7480 16490	*8310 *18320	3910 8620	5360 11820	2520 5560					

## 6. BUCKET SELECTION GUIDE

### 1) GENERAL BUCKET

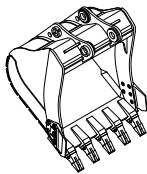
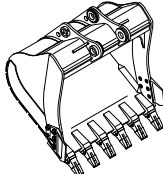
	
0.80, 0.87, 0.92, 1.10, 1.20 m <sup>3</sup> SAE heaped bucket	1.34 m <sup>3</sup> SAE heaped bucket

Capacity		Width		Weight	Recommendation					
					5.65 m (18' 6") Mono boom			5.39 m (17' 8") adjust boom		
SAE heaped	CECE heaped	Without side cutter	With side cutter		2.0 m arm (6' 7")	2.4 m arm (7' 10")	2.92 m arm (9' 7")	2.0 m arm (6' 7")	2.4 m arm (7' 10")	2.92 m arm (9' 7")
0.80 m <sup>3</sup> (1.05 yd <sup>3</sup> )	0.70 m <sup>3</sup> (0.92 yd <sup>3</sup> )	1070 mm (42.1")	1160 mm (45.7")	770 kg (1700 lb)	○	○	○	○	○	○
0.87 m <sup>3</sup> (1.14 yd <sup>3</sup> )	0.76 m <sup>3</sup> (0.99 yd <sup>3</sup> )	1140 mm (44.9")	1230 mm (48.4")	800 kg (1760 lb)	○	○	○	○	○	◐
0.92 m <sup>3</sup> (1.20 yd <sup>3</sup> )	0.80 m <sup>3</sup> (1.05 yd <sup>3</sup> )	1190 mm (46.9")	1280 mm (50.4")	820 kg (1810 lb)	○	○	◐	○	○	◐
1.10 m <sup>3</sup> (1.44 yd <sup>3</sup> )	0.96 m <sup>3</sup> (1.26 yd <sup>3</sup> )	1375 mm (54.1")	1465 mm (57.7")	890 kg (1960 lb)	○	◐	●	◐	◐	●
1.20 m <sup>3</sup> (1.57 yd <sup>3</sup> )	1.05 m <sup>3</sup> (1.37 yd <sup>3</sup> )	1390 mm (54.7")	1480 mm (58.3")	920 kg (2030 lb)	○	◐		◐	●	
1.34 m <sup>3</sup> (1.75 yd <sup>3</sup> )	1.17 m <sup>3</sup> (1.53 yd <sup>3</sup> )	1525 mm (60.0")	1615 mm (63.6")	990 kg (2180 lb)	◐	●		●		

○ Applicable for materials with density of 2000 kgf/m<sup>3</sup> (3370 lbf/yd<sup>3</sup>) or less

◐ Applicable for materials with density of 1600 kgf/m<sup>3</sup> (2700 lbf/yd<sup>3</sup>) or less

● Applicable for materials with density of 1100 kgf/m<sup>3</sup> (1850 lbf/yd<sup>3</sup>) or less

※ These recommendations are for general conditions and average use.

Work tools and ground conditions have effects on machine performance.

Select an optimum combination according to the working conditions and the type of work that is being done.

Consult your Hyundai dealer for information on selecting the correct boom-arm-bucket combination.

## 2) HEAVY DUTY AND ROCK-HEAVY DUTY BUCKET

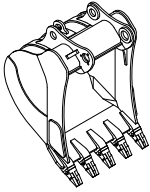
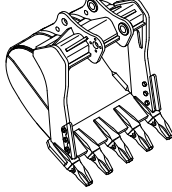
	
◆ 0.90, 1.05 m <sup>3</sup> SAE heaped bucket	◆ 0.87 m <sup>3</sup> SAE heaped bucket

Capacity		Width		Weight	Recommendation					
					5.65 m (18' 6") boom			5.39 m (17' 8") adjust boom		
SAE heaped	SAE heaped	Without side cutter	With side cutter		2.0 m arm (6' 7")	2.4 m arm (7' 10")	2.92 m arm (9' 7")	2.0 m arm (6' 7")	2.4 m arm (7' 10")	2.92 m arm (9' 7")
◆ 0.90 m <sup>3</sup> (1.18 yd <sup>3</sup> )	0.79 m <sup>3</sup> (1.03 yd <sup>3</sup> )	1210 mm (47.6")	-	880 kg (1940 lb)	○	○	◉	○	○	◉
◆ 1.05 m <sup>3</sup> (1.37 yd <sup>3</sup> )	0.92 m <sup>3</sup> (1.20 yd <sup>3</sup> )	1355 mm (53.3")	-	940 kg (2070 lb)	○	◉	●	◉	◉	●
◆ 0.87 m <sup>3</sup> (1.14 yd <sup>3</sup> )	0.77 m <sup>3</sup> (1.01 yd <sup>3</sup> )	1195 mm (47.0")	-	940 kg (2070 lb)	○	○	◉	○	○	◉

◆ : Heavy duty bucket    ◆ : Rock-Heavy duty bucket

- Applicable for materials with density of 2000 kgf/m<sup>3</sup> (3370 lbf/yd<sup>3</sup>) or less
- ◉ Applicable for materials with density of 1600 kgf/m<sup>3</sup> (2700 lbf/yd<sup>3</sup>) or less
- Applicable for materials with density of 1100 kgf/m<sup>3</sup> (1850 lbf/yd<sup>3</sup>) or less

## 7. SPECIFICATIONS FOR MAJOR COMPONENTS

### 1) ENGINE

Item	Specification
Model	Cummins QSB6.7
Type	4-cycle turbocharged charger air cooled diesel engine
Cooling method	Water cooling
Number of cylinders and arrangement	6 cylinders, in-line
Firing order	1-5-3-6-2-4
Combustion chamber type	Direct injection type
Cylinder borexstroke	107×124 mm (4.2"×4.9")
Piston displacement	6700 cc (409 cu in)
Compression ratio	17.3 : 1
Rated net horse power (SAE J1349)	174 Hp at 2000 rpm (130 kW at 2000 rpm)
Rated gross horse power (SAE J1995)	183 Hp at 2000 rpm (136 kW at 2000 rpm)
Maximum torque	85.7 kgf·m (620 lbf·ft at 1500 rpm)
Engine oil quantity	23.7 ℓ (6.2 U.S. gal)
Wet weight	520 kg (1150 lb)
High idling speed	2200 ± 50 rpm
Low idling speed	700 ± 100 rpm
Rated fuel consumption	158 g/Hp-hr at 2000 rpm
Starting motor	Denso (24 V-4.8 kW)
Alternator	Denso (24 V-95 A)
Battery	2 × 12 V × 100 Ah

### 2) MAIN PUMP

Item	Specification
Type	Variable displacement parallel axis piston pumps
Capacity	2 × 117 cc/rev
Maximum pressure	350 kgf/cm <sup>2</sup> (4980 psi) [380 kgf/cm <sup>2</sup> (5400 psi)]
Rated oil flow	2 × 234 ℓ /min (61.8 U.S. gpm / 51.5 U.K. gpm)
Rated speed	1700 rpm

[ ] : Power boost

### 3) GEAR PUMP

Item	Specification
Type	Fixed displacement gear pump single stage
Capacity	15cc/rev
Maximum pressure	40 kgf/cm <sup>2</sup> (570 psi)
Rated oil flow	25.5 ℓ /min (6.7 U.S. gpm/5.6 U.K. gpm)

### 4) MAIN CONTROL VALVE

Item	Specification
Type	9 spools
Operating method	Hydraulic pilot system
Main relief valve pressure	350 kgf/cm <sup>2</sup> (4980 psi) [380 kgf/cm <sup>2</sup> (5400 psi)]
Overload relief valve pressure	400 kgf/cm <sup>2</sup> (5690 psi)

[ ] : Power boost

### 5) SWING MOTOR

Item	Specification
Type	Fixed displacement axial piston motor
Capacity	142.8 cc/rev
Relief pressure	265 kgf/cm <sup>2</sup> (3770 psi)
Braking system	Automatic, spring applied hydraulic released
Braking torque	63.3 kgf · m (458 lbf · ft)
Brake release pressure	20.9~35.5 kgf/cm <sup>2</sup> (297~505 psi)
Reduction gear type	2 - stage planetary

### 6) TRAVEL MOTOR

Item	Specification
Type	Variable displacement bent-axis axial piston motor
Rated pressure	380 kgf/cm <sup>2</sup> (5400 psi)
Counter balance valve	Applied
Capacity	160/61 cc/rev



## 7) POWER TRAIN

Item	Description	Specification	
Transmission	Type	2 speed power shift transmission	
	Gear ratio	1st	4.87
		2nd	1.20
	Clutch pressure	30~32 kgf/cm <sup>2</sup> (427~455 psi)	
Parking brake	Type	Multi disc brake integrated in transmission	
	Maximum braking torque	2937 kgf · m (21240 lbf · ft)	
Axle / Wide axle	Type	4 wheel drive with differential	
	Gear ratio	16.0	
	Brake	Multi disc brake	
	Brake pressure	81.6 kgf/cm <sup>2</sup> (1160 psi)	
	Steering pressure	204 kgf/cm <sup>2</sup> (2900 psi)	

## 8) POWER TRAIN GEAR PUMP

Item	Description
Type	Fixed displacement gear pump (tanedm)
Capacity	19.4 / 8.2 cc / rev [22.4 / 8.2 cc / rev] (engine PTO)
Rated flow	36.2 / 15.3 l / min (9.6 / 4.0 U.S.gpm / 8.0 / 3.4 U.K.gpm) [41.8 / 15.3 l / min (9.6 / 4.0 U.S.gpm / 8.0 / 3.4 U.K.gpm)]

※ [ ] Rotating option

## 9) REMOTE CONTROL VALVE

Item	Description	Specification
Type		Pressure reducing
Operating pressure	Minimum	6.5 kgf / cm <sup>2</sup> (92 psi)
	Maximum	25 kgf / cm <sup>2</sup> (360 psi)
Single operation stroke	Lever (1, 3 port)	90 mm (3.5 in)
	Lever (2, 4 port)	130 mm (4.4 in)

## 10) CYLINDER

Item		Specification
Boom cylinder	Bore dia × Rod dia × Stroke	Ø120 × Ø85 × 1290 mm
	Cushion	Extend only
Arm cylinder	Bore dia × Rod dia × Stroke	Ø140 × Ø100 × 1510 mm
	Cushion	Extend and retract
Bucket cylinder	Bore dia × Rod dia × Stroke	Ø125 × Ø85 × 1055 mm
	Cushion	Extend only
Dozer cylinder	Bore dia × Rod dia × Stroke	Ø125 × Ø75 × 222 mm
	Cushion	Extend only
Outrigger cylinder	Bore dia × Rod dia × Stroke	Ø130 × Ø80 × 427 mm
	Cushion	-
Adjust boom cylinder	Bore dia × Rod dia × Stroke	Ø120 × Ø85 × 1010 mm
	Cushion	Extend only
Adjust cylinder	Bore dia × Rod dia × Stroke	Ø170 × Ø105 × 754 mm
	Cushion	-

※ Discoloration of cylinder rod can occur when the friction reduction additive of lubrication oil spreads on the rod surface.

※ Discoloration does not cause any harmful effect on the cylinder performance.

## 11) BUCKET

Item	Capacity		Tooth quantity	Width	
	SAE heaped	CECE heaped		Without side cutter	With side cutter
Standard	0.80 m <sup>3</sup> (1.05 yd <sup>3</sup> )	0.70 m <sup>3</sup> (0.92 yd <sup>3</sup> )	5	1070 mm (42.1")	1160 mm (45.7")
Option	0.87 m <sup>3</sup> (1.14 yd <sup>3</sup> )	0.76 m <sup>3</sup> (0.99 yd <sup>3</sup> )	5	1140 mm (44.9")	1230 mm (48.4")
	0.92 m <sup>3</sup> (1.20 yd <sup>3</sup> )	0.80 m <sup>3</sup> (1.05 yd <sup>3</sup> )	5	1190 mm (46.9")	1280 mm (50.4")
	1.10 m <sup>3</sup> (1.44 yd <sup>3</sup> )	0.96 m <sup>3</sup> (1.26 yd <sup>3</sup> )	5	1375 mm (54.1")	1465 mm (57.7")
	1.20 m <sup>3</sup> (1.57 yd <sup>3</sup> )	1.05 m <sup>3</sup> (1.37 yd <sup>3</sup> )	5	1390 mm (54.7")	1480 mm (58.3")
	1.34 m <sup>3</sup> (1.75 yd <sup>3</sup> )	1.17 m <sup>3</sup> (1.53 yd <sup>3</sup> )	6	1525 mm (60.0")	1615 mm (63.6")
	◆0.90 m <sup>3</sup> (1.18 yd <sup>3</sup> )	0.79 m <sup>3</sup> (1.03 yd <sup>3</sup> )	5	1210 mm (47.6")	-
	◆1.05 m <sup>3</sup> (1.37 yd <sup>3</sup> )	0.92 m <sup>3</sup> (1.20 yd <sup>3</sup> )	5	1355 mm (53.3")	-
	◆0.87 m <sup>3</sup> (1.14 yd <sup>3</sup> )	0.77 m <sup>3</sup> (1.01 yd <sup>3</sup> )	5	1195 mm (47.0")	-

◆ : Heavy duty bucket

◆ : Rock-Heavy duty bucket

## 8. RECOMMENDED OILS

HYUNDAI genuine lubricating oils have been developed to offer the best performance and service life for your equipment. These oils have been tested according to the specifications of HYUNDAI and, therefore, will meet the highest safety and quality requirements.

We recommend that you use only HYUNDAI genuine lubricating oils and grease officially approved by HYUNDAI.

Service point	Kind of fluid	Capacity ℓ (U.S. gal)	Ambient temperature °C( °F)							
			-50 (-58)	-30 (-22)	-20 (-4)	-10 (14)	0 (32)	10 (50)	20 (68)	30 (86)
Engine oil pan	Engine oil	23.7 (6.26)	★SAE 5W-40				SAE 30			
			SAE 10W				SAE 10W-30			
Transmission case		2.5 (0.66)	SAE 15W-40							
DEF/ AdBlue® tank	Mixture of urea and deionized water	27.0 (7.1)	ISO 22241, High-purity urea + deionized water (32.5:67.5)							
Swing drive	Gear oil	6.2 (1.6)	★SAE 75W-90				SAE 80W-90			
			SAE 85W-90 LSD or UTTO							
Front axle	Gear oil	Center : 9.6 (2.5) Hub : 2.5×2 (0.7×2)	SAE 85W-90 LSD or UTTO							
Rear axle		Center : 13.5 (3.6) Hub : 2.5×2 (0.7×2)								
Front wide axle	Gear oil	Center : 11.0 (2.9) Hub : 2.5×2 (0.7×2)	SAE 85W-90 LSD or UTTO							
Rear wide axle		Center : 15.0 (4.0) Hub : 2.5×2 (0.7×2)								
Hydraulic tank	Hydraulic oil	Tank: 165 (43.6)	★ISO VG 15				ISO VG 32			
		System: 340 (89.8)	ISO VG 46, HBHO VG 46★ <sup>3</sup>				ISO VG 68			
Fuel tank	Diesel fuel★ <sup>1</sup>	310 (81.9)	★ASTM D975 NO.1				ASTM D975 NO.2			
Fitting (Grease nipple)	Grease	As required	★NLGI NO.1				NLGI NO.2			
Radiator (Reservoir tank)	Mixture of antifreeze and soft water★ <sup>2</sup>	40 (10.6)	Ethylene glycol base permanent type (50 : 50)							
			★Ethylene glycol base permanent type (60 : 40)							

**SAE** : Society of Automotive Engineers

**API** : American Petroleum Institute

**ISO** : International Organization for Standardization

**NLGI** : National Lubricating Grease Institute

**ASTM** : American Society of Testing and Material

**UTTO** : Universal Tractor Transmission Oil

**DEF** : Diesel Exhaust Fluid, DEF compatible with AdBlue®

★ : Cold region

Russia, CIS, Mongolia

★<sup>1</sup> : Ultra low sulfur diesel

- sulfur content ≤ 15 ppm

★<sup>2</sup> : Soft water

City water or distilled water

★<sup>3</sup> : Hyundai Bio Hydraulic Oil

- For more information, contact HYUNDAI dealers.

※ Using any lubricating oils other than HYUNDAI genuine products may lead to a deterioration of performance and cause damage to major components.

※ Do not mix HYUNDAI genuine oil with any other lubricating oil as it may result in damage to the systems of major components.

※ Do not use any engine oil other than that specified above, as it may clog the diesel particulate filter(DPF).

※ For HYUNDAI genuine lubricating oils and grease for use in regions with extremely low temperatures, please contact HYUNDAI dealers.