

GROUP 2 FRONT AND REAR AXLE

1. PREPARATION

- 1) Clean the area of dirt and debris.
- 2) Block the loader securely with four wheels clear of the ground.
- 3) Remove the wheels on the side of the machine that the travel motor is to be removed on.
- 4) Remove the oil drain plug and allow oil to drain from the housing into a receptacle.
- 5) Remove the cover.

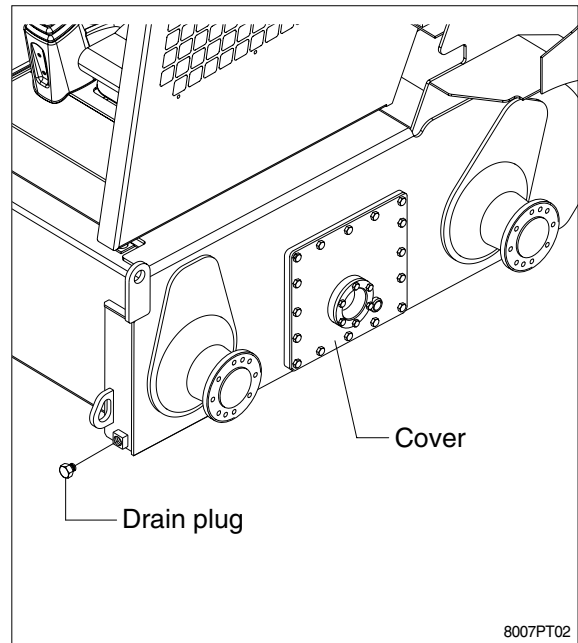

2. REMOVAL OF THE AXLE

- 1) Remove the front axle cover and gasket.
- 2) Remove the split pin, nut and washer from the axle.
- 3) Using a special axle puller tool, remove the axle and the outer bearing cone. The cone will come along with the axle. The outer bearing cup, inner bearing cup and cone and sprocket will remain inside the housing.

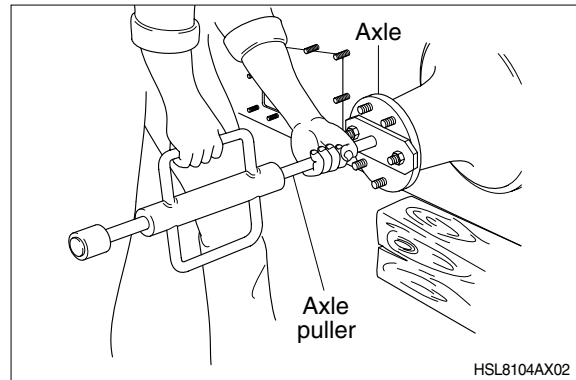

- 4) Remove sprocket and inner bearing cone through the inspection cover opening.
- 5) Remove the chain(Front, rear) through the inspection cover opening.
- 6) Remove the outer bearing cups with an inside bearing puller or brass punch. Use care if using the brass punch.
- 7) Carefully punch out the inner bearing cup.
- 8) Using a bearing puller, remove the outer bearing cone from the axle.
- 9) Remove and discard oil seal.

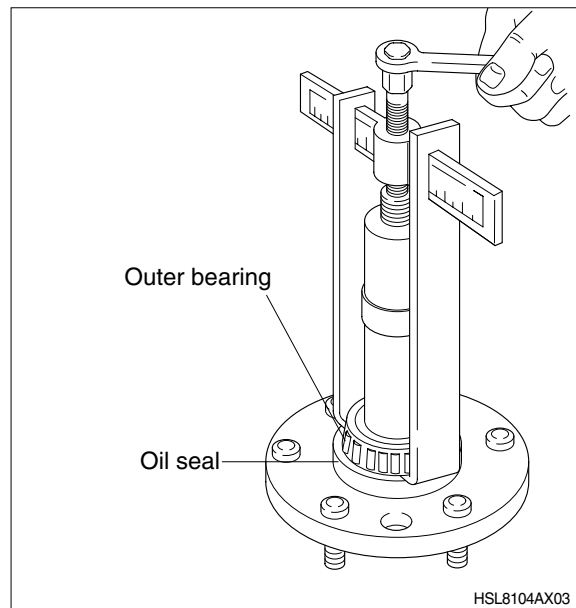

3. CLEANING AND INSPECTION

- 1) Clean the bearing cones and cups in a cleaning solvent.
- 2) Remove all grease from the bore in the axle housing.
- 3) Inspect the bearing cones and cups for flat areas, pitting, scoring and other damage.

4. REPAIR OR REPLACEMENT

- 1) Replace oil seal with a new one.
 - 2) Replace bearing cones and cups if they have flat areas, are pitted, scored or damaged.
- ※ **If a bearing cone or cup is damaged, both parts must be replaced at the same time.**

5. INSTALL OF THE AXLE

- 1) Shrink-fit bearing cups into the housing by refrigerating or cooling before pressing them into place.
- 2) Lubricate the new oil seal and install it, seal part number facing the flange end of the axle, on the seal surface of the axle.
- 3) Heat or press the outer axle bearing cone onto the axle. Be sure the bearing is fully seated.

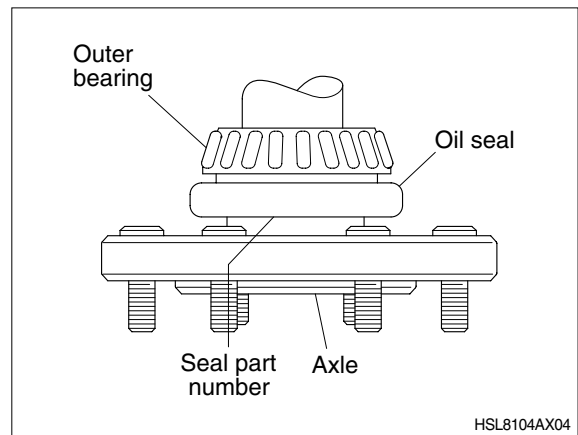

※ **If the bearing cone is heated, use an induction type heater(Hot plate).**

- 4) When the bearing has cooled, pack it with multi purpose lithium bass grease.
- 5) Fill oil into the front and rear axle housing.
(SAE 15W-40)
· Oil quantity : 9.2 l (2.4U.S.gal)
- 6) Install the axle assembly in the housing.
- 7) Pack the inner bearing cone with bearing grease.
- 8) Reach through the inspection cover opening and install the inner bearing cone on the axle. Be sure it is seated properly in the cup.

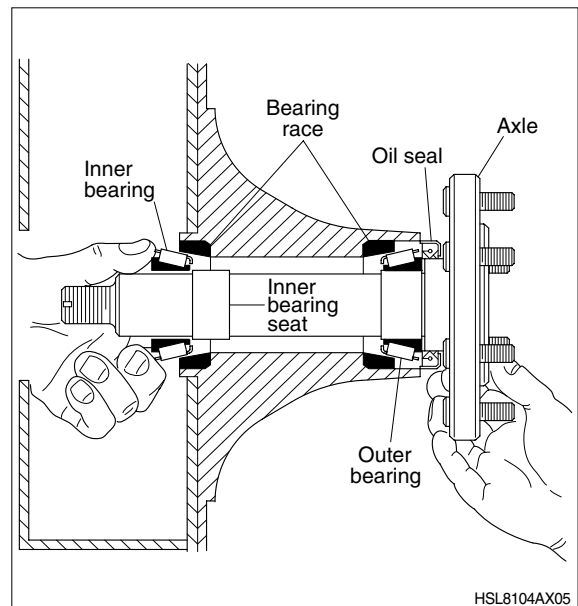

- 9) Reach through the inspection cover opening and install and sprocket on the axle. The hub end of the sprocket must face the flange end of the axle.
- 10) Place a bolt through the hole in the axle flange to prevent the axle from turning.
- 11) Apply a gasket sealer to the outside of seal.
- 12) Install washer and nut.
- 13) Torque nut as close to 76lb · ft(103Nm) possible without backing off the nut to align the split pin holes.
Do not back off the nut.
- 14) Install a split pin through torqued nut.
- 15) Secure the inspection cover and gasket to the final drive housing with four nuts.

