

SECTION 2

HYDROSTATIC DRIVE SYSTEM

Specifications	2.1
Chart	pg. 2-3
General Information	2.2
Introduction	pg. 2-4
Trouble Shooting	2.3
Chart	pg. 2-5 ~ 7
Diagnose Steps	pg. 2-8
Pressure Tests	2.4
Procedure	pg. 2-9
Towing Procedure	2.5
Procedure	pg. 2-10
Flushing The Hydraulic System	2.6
General Information	pg. 2-11
Cleaning	pg. 2-12 ~ 13
Start-up Procedure	2.7
Procedure	pg. 2-14
Gear Pump Replacement	2.8
Procedure	pg. 2-15
Tandem Pump Replacement	2.9
Procedure	pg. 2-16 ~19
Tandem Pump Parts Diagram	2.10
Parts Illustrations	pg. 2-20 ~ 23
Drive Motor	2.11
General Information	pg. 2-24 ~ 27
Removal	pg. 2-28 ~ 29
Replacement	pg. 2-30 ~ 31
Disassembly	pg. 2-32 ~ 39
Assembly	pg. 2-40 ~ 44
Torque Specifications	2.12
Torque Chart	pg. 2-45
Conversion Chart	2.13
Conversion Factors	pg. 2-46 ~ 47



HYDROSTATIC CIRCUIT 2.1

Hydrostatic Circuit and System Pressure Schematic

- A** High Pressure Relieved at 345 Bar (5000PSI)
- B** Aux. Press. Relief Set at 2400 PSI (207 Bar)
- C** System Charge Pressure 200 PSI Minimum (13.8 Bar)
- D** Return Pressure
- E** Suction Line (Vacuum) 4 - 6 Hg @ 160°F (71°C)

2

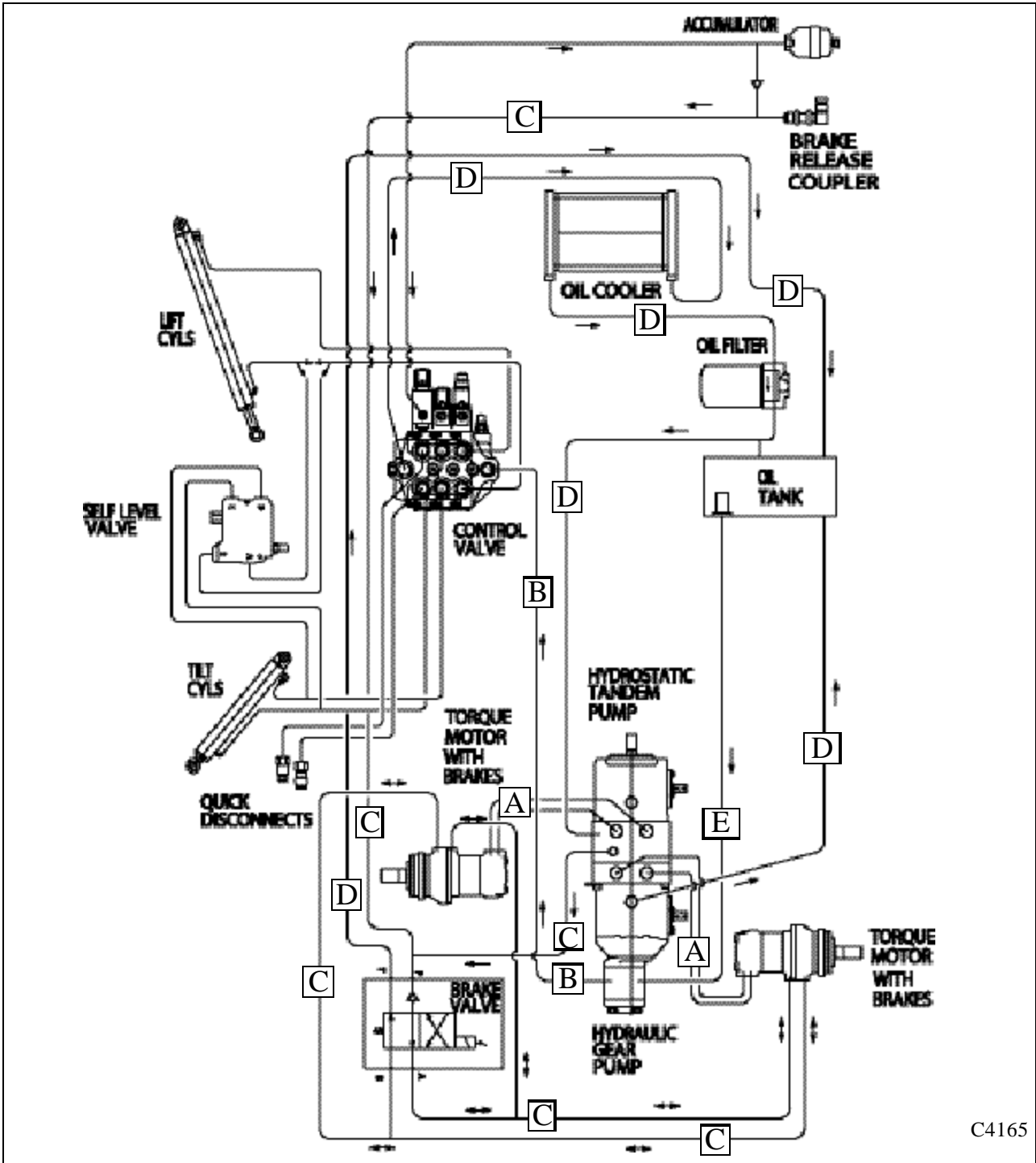

C4165

SPECIFICATIONS 2.1

Hydrostatic Tandem Pump

Pump Type	Variable Displacement, Reversible Piston
Brand Name of Pump	Sauer-Danfoss
Series Type	40 / M44
No. Of Drive Pumps	2 (TWO)
Mounting	Tandem
Rotation (viewed from shaft end)	Clockwise
Operating Speed	2800 RPM (+ / - 50 RPM)
Pump Displacement	2.65 cu. in. (44cc)
Minimum Pump Output (flow)	17.1 gal. (64.7L) / Minute @ 1800RPM @ 2000 PSI (136.1 Bar) Over Measured Charge Pressure
No. Of Relief Valves	2 (TWO)
Relief Valve Setting	345 Bar (5000 PSI)
Max. Allowable Case Pressure	25 PSI (1.7 Bar)
Charge Pump Type	14.6cc/rev. Geroter Style
Charge Pressure	200 PSI Min. (13.8 Bar)
Hydrostatic Repair Manual	Thomas P / N 44232 Sauer Sundstrand P / N BLN-9992



Hydraulic Drive Motor

Drive Motor Type	Geroter Torque Motor With Brake
Brand Name	Sauer-Danfoss
Series Type	TMT 500 FLV
Rotation	Dual
No. Of Drive Motors	2 (TWO)
Drive Motor Displacement	31.9 cu. in. (523cc)
Max. Case Pressure	250 PSI (17.3 Bar)

Reservoir

Fluid Type	10w30 API Class SJ Oil
Reservoir Filtration	One 100 Micron Screen Element
Hydraulic Oil Filtration	One 5 Micron Element
Hydraulic Element	P / N 35243

GENERAL INFORMATION 2.2

Introduction:

2

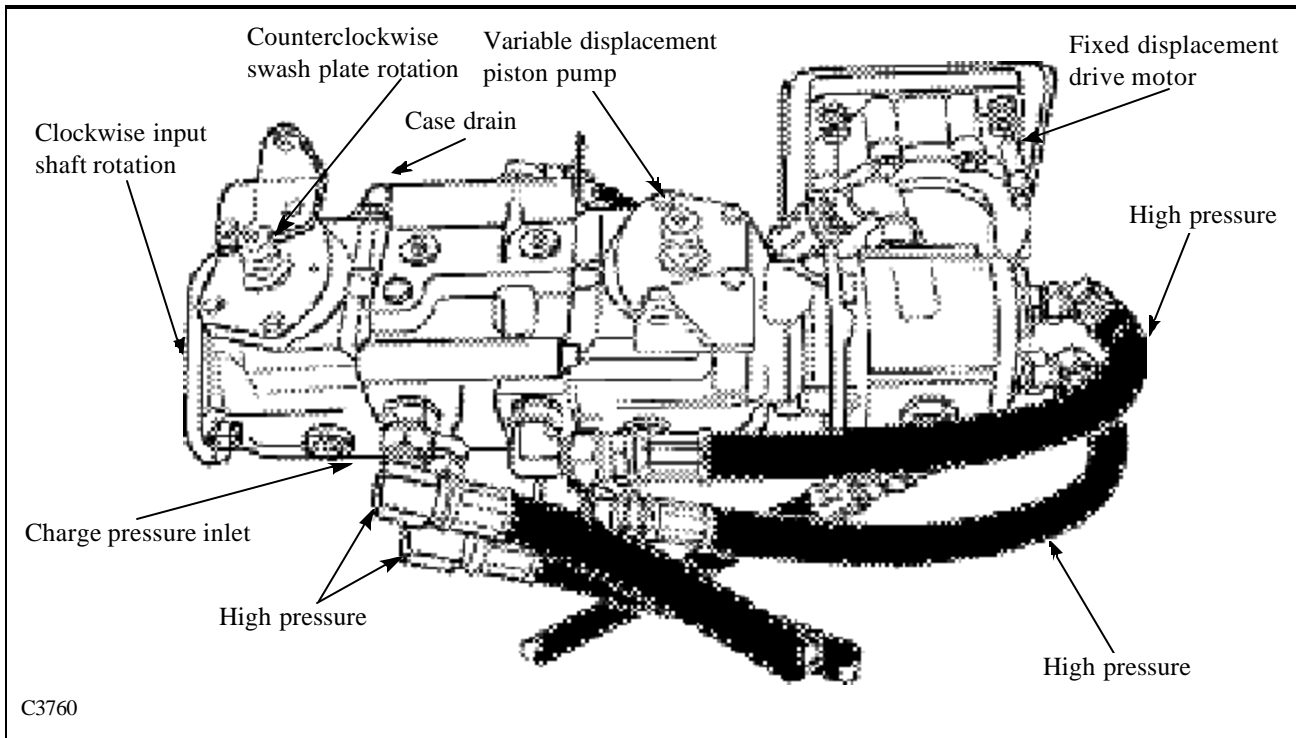

The driveshaft of the piston pump is rotated by the engine. The piston block which is splined to the driveshaft also turns. The piston block, rotating group, consists of 9 piston assemblies which have free swiveling shoes swagged on the ball end of each piston assembly. The shoe end of the piston rides against the smooth machined surface of the swashplate. With the swashplate in the neutral position, the piston assemblies do not reciprocate in the piston block, but are rotating. No oil is drawn into or discharged from the pump. The pump is in a zero displacement position and the loader remains stationary.

With the swashplate in the neutral position, the pressure of the charge oil, which ranges from 200 psi (13.8 Bar), is able to unseat both check valves and supply oil to both sides of the pump because of the balance in pressure. Very little charge oil volume is required in the neutral position so the excess oil is bypassed over the charge pressure relief valve and recirculated back to the reservoir. The oil that leaks internally in the pump and motor collects in their body housings and is returned to the reservoir by external case drain in the pump and motors. This leakage oil is the only oil the charge check replenishes. This makes the design a closed loop system.

As the steering lever is moved forward, or reverse, the loader starts a directional movement. As the swashplate begins to move, the piston assemblies start to reciprocate in the piston block. As the steering lever continues further movement the cam angle increases, the pistons reciprocate further, more oil is pumped and the speed of the loader is increased.

When the swashplate begins to move the check valve on the discharge, or pressure, side seats because of the higher pressure differential. The other check valve remains open on the intake or low pressure side to continue supplying the closed loop system with charge oil.

The drive motor, which is a fixed displacement type, delivers a constant output torque for a given pressure throughout the speed range of the motor.

The movement of the pump swashplate, forward or reverse, controls the direction of the drive motor rotation.

The function of the pressure relief valve is to relieve the pressure side of the system of excessive high pressure when the loader encounters a heavy load or stalls out.

When the relief valve senses an over load it unseats, allowing excess pressure and volume to flow into the low pressure side of the pump. A small volume of oil starts to flow across to the other relief valve. This relief valve is exposed to the low pressure on the intake side of the pump and is seated by the spring tension within the relief valve body.

The small volume of oil being bypassed is enough to unseat the relief valve and let it recirculate back into the inlet side of the pump. As the pressure continues to build on the pressure side, a larger volume of oil flows and at a greater speed through the drilled orifice in the relief valve cartridge, causing a pressure drop inside the relief valve. The surrounding pressure is now able to unseat the relief valve and bypass maximum volume of oil. The system reliefs function the same for both sides of the system.

TROUBLE SHOOTING 2.3

Symptom: Neutral Difficult Or Impossible To Find

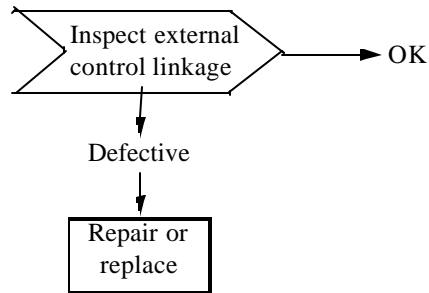

Symptom: System Operating Hot

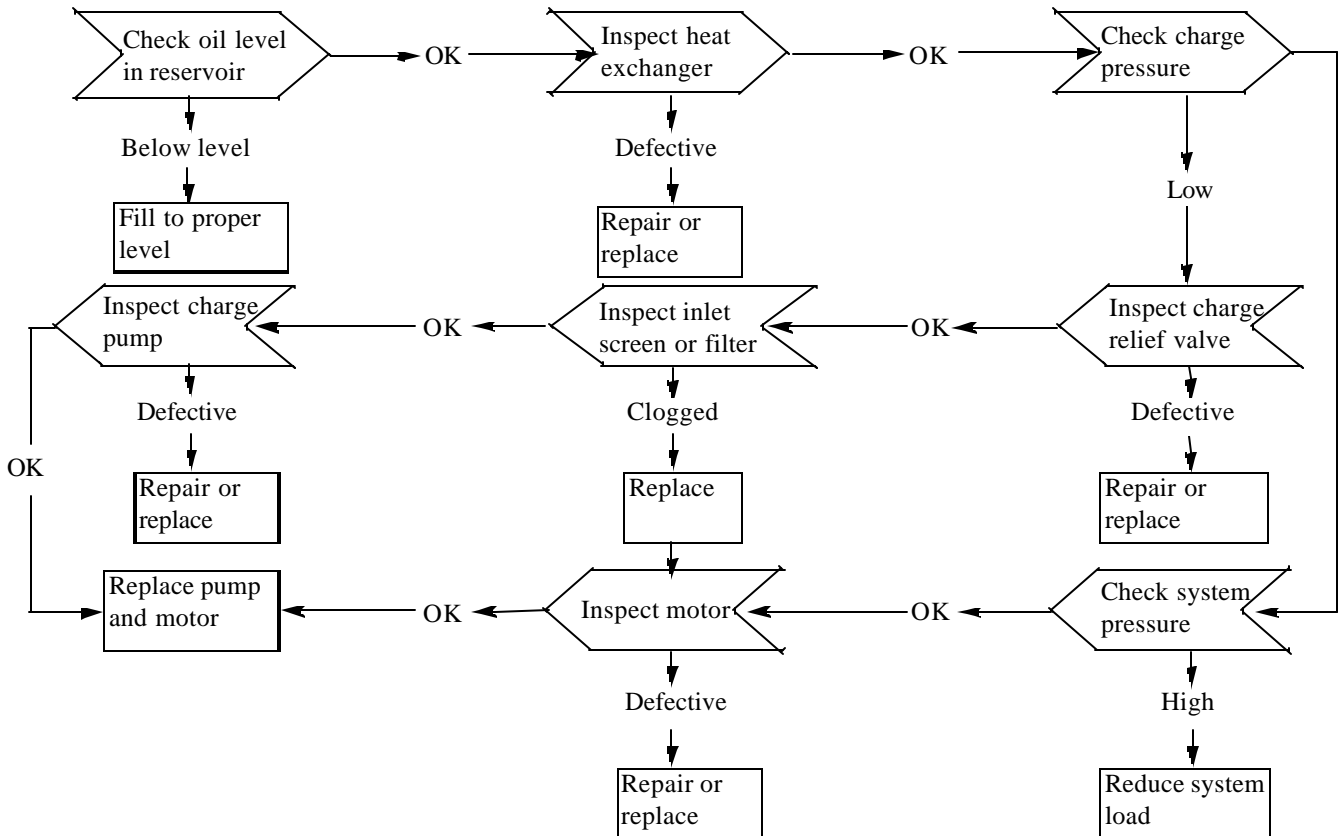

TROUBLE SHOOTING 2.3

Symptom: Operates In One Direction Only

2

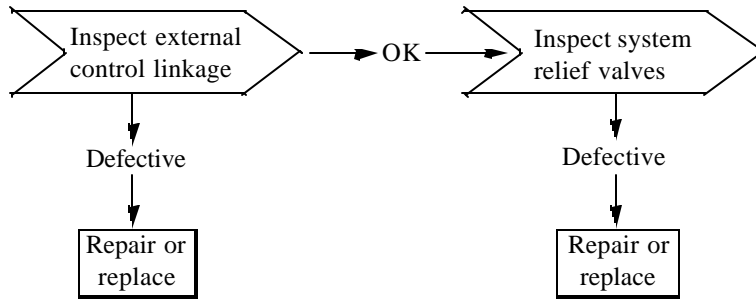

Symptom: System Response Sluggish

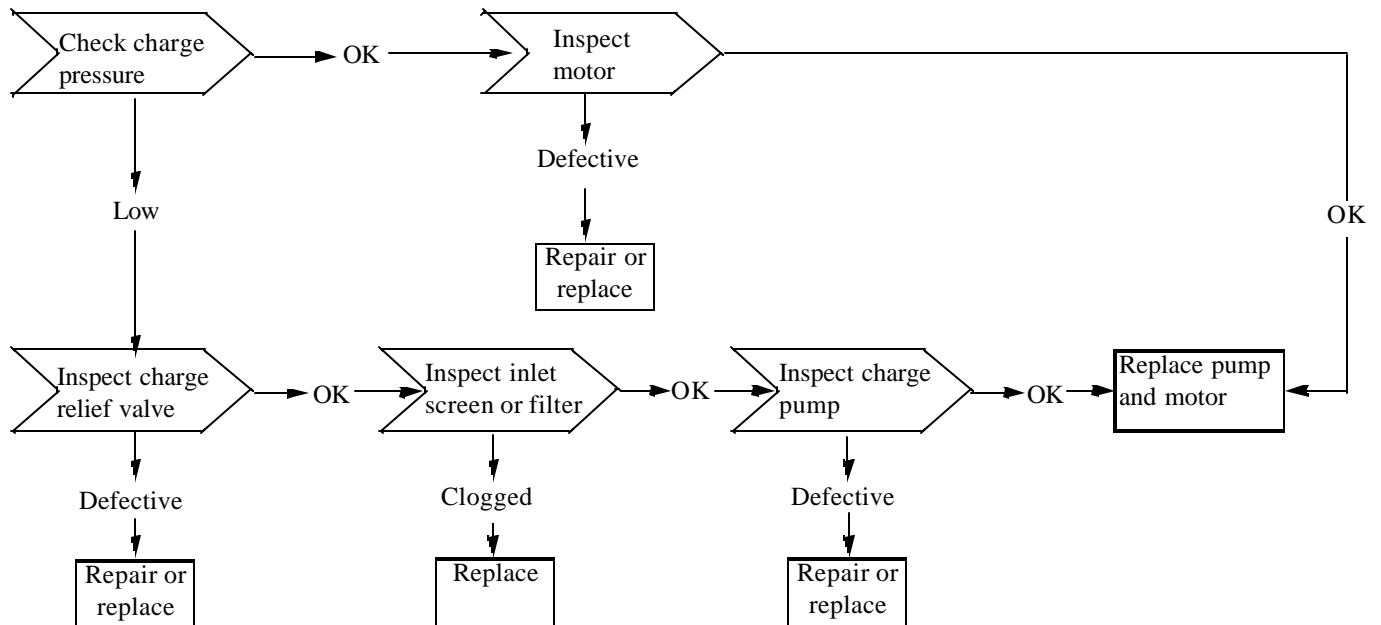

TROUBLE SHOOTING 2.3

Symptom: System Will Not Operate In Either Direction

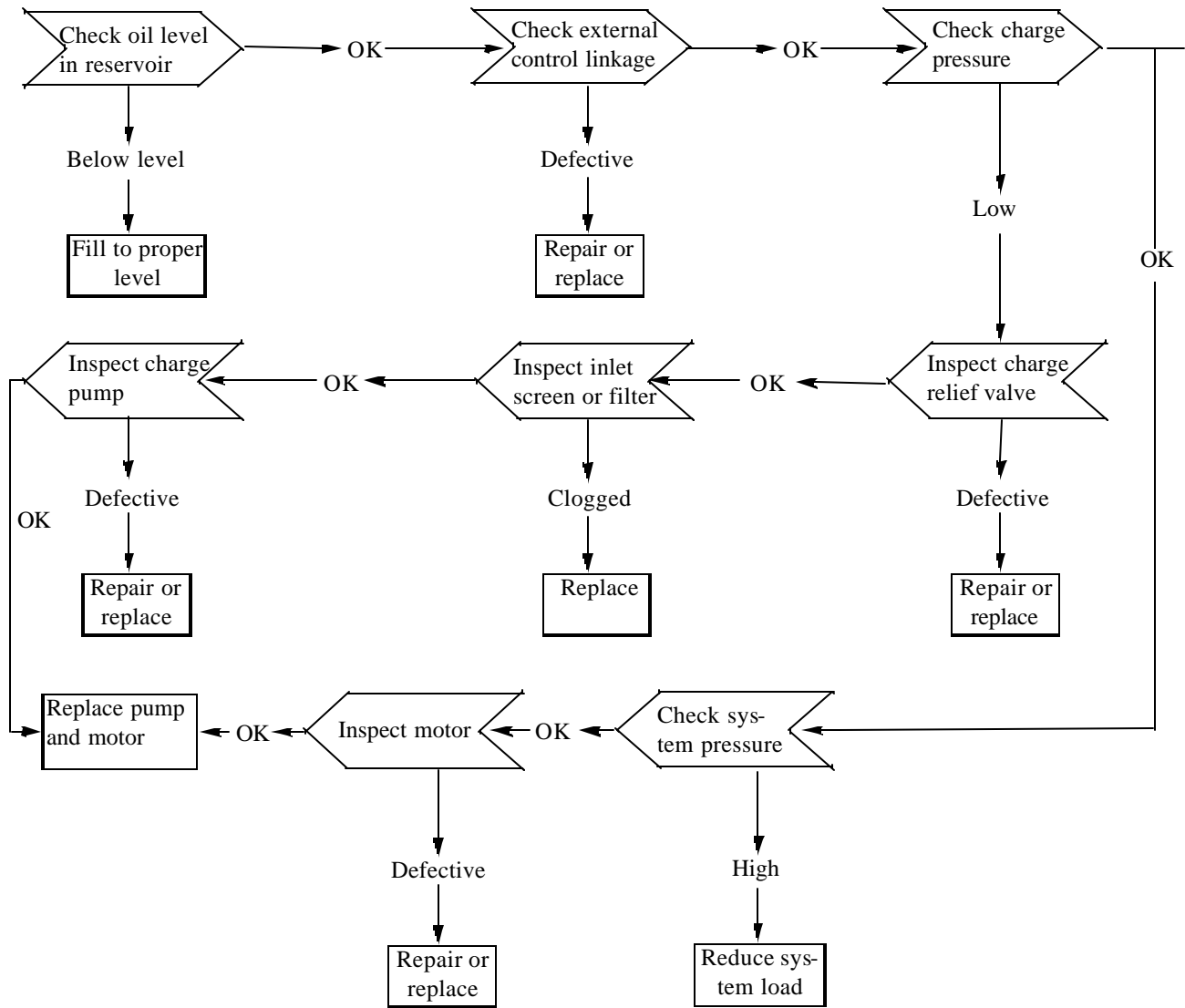

TRUBLE SHOOTING 2.3

System Diagnosing Steps And Special Tools

2

- 1 Check oil level in reservoir:**
 - a. fill to proper level as marked on site tube.
- 2 Inspect external control linkage for:**
 - a. misadjustment or disconnection
 - b. binding, bending or breakage
 - c. misadjusted, damaged or broken hydroback
- 3 Inspect servo control valve for: (if used)**
 - a. proper inlet pressure
 - b. misadjusted or damaged neutral return spring
 - c. galled or stuck control spool
 - d. galled or stuck servo piston
- 4 Inspect heat exchanger for:**
 - a. obstructed air flow
 - b. improper plumbing (inlet to outlet)
 - c. obstructed fluid flow
- 5 Inspect inlet filter or screen for:**
 - a. plugged or clogged screen or filter
 - b. obstructed inlet or outlet
 - c. open inlet to charge pump (open line)
- 6 Check charge pressure:**
 - a. follow test procedures section 2.5
- 7 Inspect charge relief valve for:**
 - a. poppet held of seat
 - b. damaged or broken spring
 - c. damaged valve seat
 - d. improper charge relief setting
- 8 Inspect charge pump for:**
 - a. broken or missing drive coupling
 - b. damaged or missing o-rings
 - c. galled or broken geroter set
- 9 Inspect system relief valves for:**
 - a. damaged or broken springs
 - b. valve held of seat
 - c. damaged valve seat
 - d. improper pressure relief settings
- 10 Check system pressure:**
 - a. follow test procedures section 2.5
- 11 Inspect hydraulic motor for:**
 - a. disconnected coupling

Photographs in the right hand column show some of the special tools that may be required to diagnose and repair the hydrostatic system.

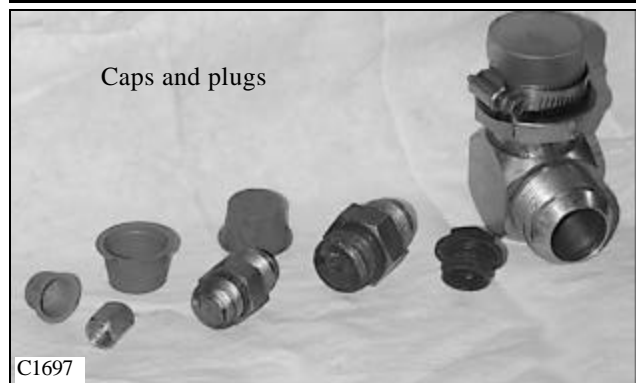
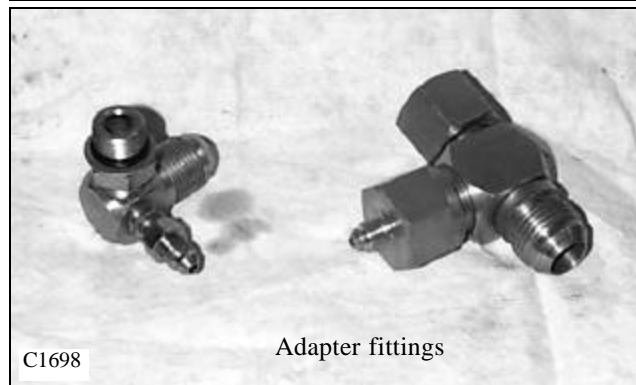
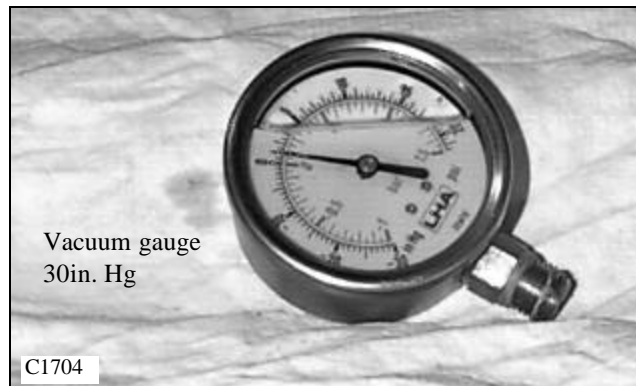
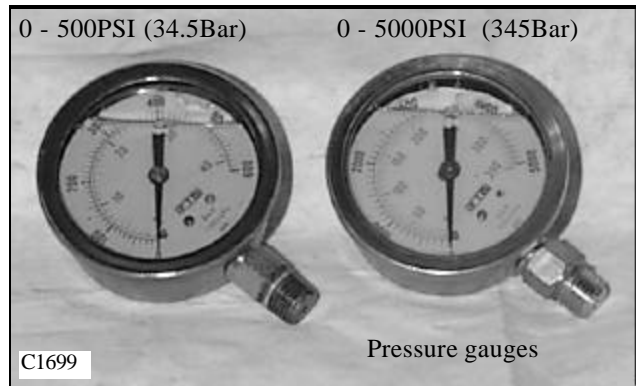

PRESSURE TESTS 2.4

The following photos show the various port locations available on the hydrostatic tandem pump for checking system pressure.

Completing these pressure test will diagnose any mechanical problem in the hydrostatic system.

WARNING

Use caution when dealing with hydraulic fluid under pressure. Escaping fluid under pressure can penetrate the skin and cause serious injury.

Installing a gauge into the high pressure gauge ports 'A', 'B', 'C', or 'D' will verify the status of the high pressure relief valves.

Checking the pressure at port 'E' will give accurate charge pressure reading.

Checking the pressure at port 'F' will verify case drain pressure.

Measuring the vacuum at the charge pump inlet can help locate the inlet lines and filters. It would be necessary to tee into the charge pump line fitting.

Snubbers are recommended to protect the gauges from pressure spikes. Frequent gauge calibration is necessary to insure accuracy.

Gauge Information		
A	System Pressure Gauge	10,000 PSI Gauge (690 Bar) 9/16 - 18 O-Ring Fitting
B	System Pressure Gauge	10,000 PSI Gauge (690 Bar) 9/16 - O-Ring Fitting
C	System Pressure Gauge	10,000 PSI Gauge (690 Bar) 9/16 - O-Ring Fitting
D	System Pressure Gauge	10,000 PSI Gauge (690 Bar) 9/16 - O-Ring Fitting
E	Charge Pressure Gauge Port	500 PSI Gauge (34.5 Bar) 7/8 - 14 O- Ring Fitting
F	Case Drain Port	500 PSI Gauge (34.5 Bar) 1 - 1/16 - 12 O-Ring Fitting
G	Charge Pump Inlet Vacuum	Vacuum Gauge (30 in. Hg) Tee Into Charge Pump Inlet

Tandem pump flow can also measure pump performance.

- 1 Connect a flow meter between the high pressure ports, one section at a time.
- 2 Start the engine and increase operating speed between 1775 ~ 1800 RPM.
- 3 Restrict the flow to show 2000 PSI (137.8 Bar) over charge inlet pressure.

Example: Charge pressure = 220 PSI (15.2 Bar) Gauge pressure reading would need to be 2220 PSI (153 Bar).

- 4 Minimum flow reading should be 17.1 gal / min. (64.7 L / min).

LH side and top view

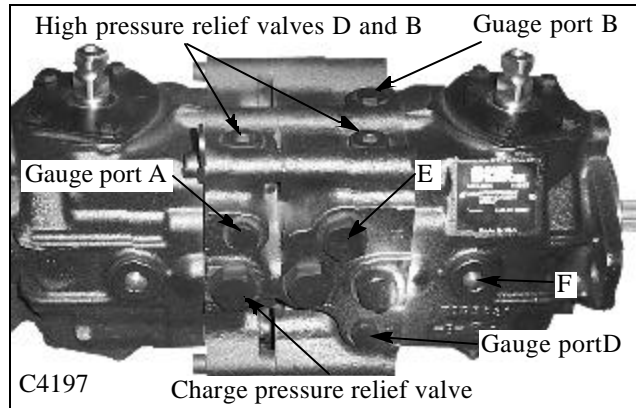

NOTE: Internal charge pump model shown

RH side and bottom view

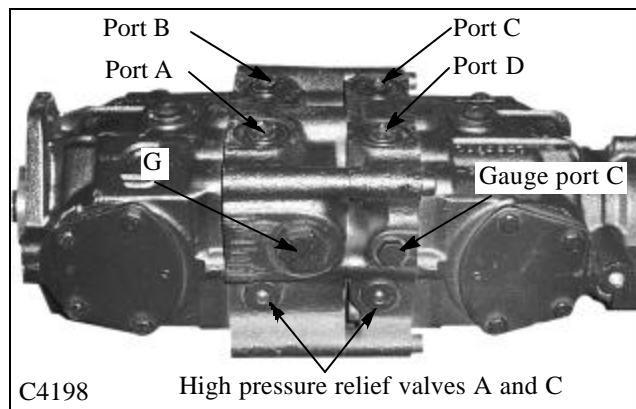

WARNING

Raise the machine securely from the ground before performing system checks to prevent sudden movement.

2

TOWING 2.5

Towing Procedure

In the event the loader has malfunctioned or failed, the loader may be moved a short distance by following the procedure below.

2



WARNING

Failure to follow the proper towing procedure may cause damage to the hydrostatic drive system.

- 1 Remove the seat and hydrostatic shield.
- 2 Loosen the high pressure relief valve caps 4 complete turns. There are 4 high pressure relief valves, 2 on the top side, and 2 on the bottom side of the tandem pump. Be sure to loosen all 4. (fig. C3665) Torque caps 30 to 50 ft / lbs (41 to 68 N.m.) upon reassembly.
- 3 The loader parking brake system is released by hydrostatic pressure. To release the parking brake when the unit has failed you must pressurize the brake system manually. A service override for the brake valve has been incorporated for use by Thomas Dealers. The normal position of the plunger is down and turned into the locked position. To release the brake, turn the release plunger counter clockwise. (fig. C3666) Access of the small quick connector for the 175 in the engine compartment. (fiq.C3870) Access the small quick connector for the 1700 in the tandem compartment (fiq. C3871) Use a port -a - power to pressurize this line to 200 psi (13.8 bar). The brakes are now released.



WARNING

Be sure to return the brake valve plunger to the normal position after servicing the loader.



CAUTION

To prevent damage to the drive motors, do not exceed speed of 1 MPH.

- 4 Use the front frame mounted tie downs to attach pulling devise. (fig. C3447) Use the rear tie downs to pull the loader backwards. (fig. C3446)



WARNING

Use chains or cables rated a minimum of 1 and 1/2 times the gross vehicle weight.

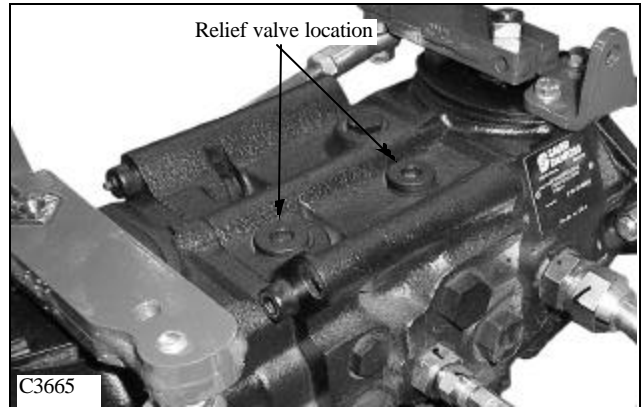

C3665

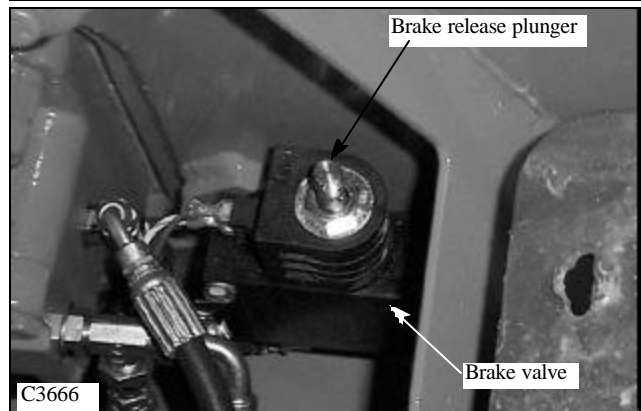

C3666

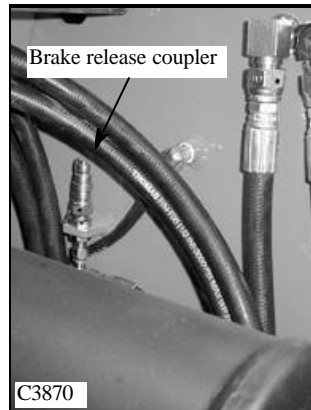

C3870

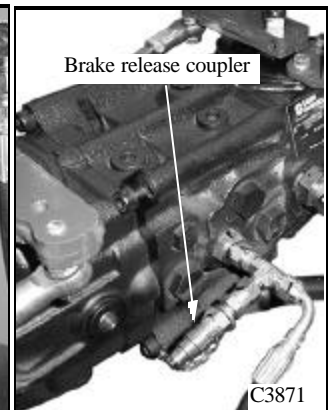

C3871

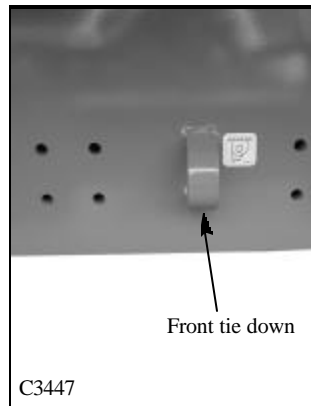

C3447

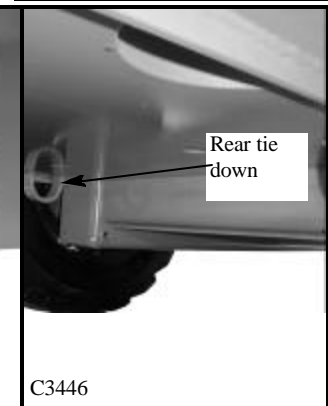

C3446

FLUSHING THE HYDRAULIC SYSTEM 2.6

General Information

Contamination in the hydraulic system is a major cause of component failure. Contamination can enter the hydraulic system in any of the following ways:

- 1 When draining the hydraulic system.
- 2 When disassembling components.
- 3 Making auxiliary connections with dirty couplers.
- 4 Normal component wear.
- 5 Component failure

The best way to remove contaminants from the hydrostatic drive system is to disassemble each component and flush and clean thoroughly.

The hydraulic control circuits may be cleaned by attaching a suitable hydraulic filter to the auxiliary couplings and circulating the fluid through it.



Contamination Types

There are 2 types of contamination, microscopic, or non visible, and visible. Microscopic contamination is suspended in the fluid and moves freely through the hydraulic circuits. Examples of problems caused by microscopic contaminants include the following:

- 1 Cylinder rod seal leaks.
- 2 Control valve spools do not return to neutral.
- 3 Hydraulic system has a high operating temperature.
- 4 Components wear rapidly.

Visible contamination is foreign material that can be found by sight, touch or odor. Some examples of visible contamination include the following:

- 1 Particles of metal or dirt in the oil.
- 2 Air in the oil.
- 3 Odor of burned oil.
- 4 Water in the oil.

FLUSHING THE HYDRAULIC SYSTEM 2.6

Cleaning The System

The first step in cleaning the hydraulic system is to determine if you have visible or microscopic contamination.

If the contamination is visible, do the following steps:

1 Change the hydraulic oil by removing the drain plug in the bottom of the hydraulic oil reservoir. (fig. C3661) Be prepared to contain approximately 56 litres(14.8 gal) of fluid.

2 Check the extent of the contamination by disassembling 1 each of the hydraulic cylinders. Check the cylinders for damage. Repair or replace the cylinders as required. If you determine the damage was caused by severe contamination and is not the result of normal wear, it will be necessary to remove, clean and repair all valves, pumps, lines, cylinders, etc.

3 Replace all hydraulic filters.

If the contamination is determined to be microscopic, perform the following steps:

1 Change the hydraulic oil by removing the plug in the bottom of the oil reservoir. (fig. C3661) Be prepared to contain approximately 56 litres (14.8 gal) of fluid.

2 Connect an external 5 micron filtering system, capable of sustaining minimum of 2000 PSI (138 Bar) and has a back pressure gauge, to the auxiliary couplings. (fig. C3646)

3 Start the engine and let it idle at approximately half throttle.



WARNING

Be sure to use a filtering system capable of handling the pressure of the hydraulic system.

4 Engage the auxiliary circuit. Check to make sure the filtering system is not over taxed by the loaders hydraulic system pressure. Adjust engine idle accordingly to match the filtering systems capacity. This may vary as the filter becomes dirty, you may need to decrease engine RPM. Circulate the oil through filter for 30 minutes.

5 As the oil is being circulated through the auxiliary circuit, raise the liftarms up and down in full stroke cycles. Repeat this exercise for 15 minutes.

6 Cycle the bucket tilt cylinders in the same manner as above. Repeat the exercise, in full extension and retraction, for 15 minutes.

7 Install new hydraulic oil filters. (fig. C3650)

8 Start the engine and check for leaks. Replenish the hydraulic oil reservoir as required. (fig. C3431)

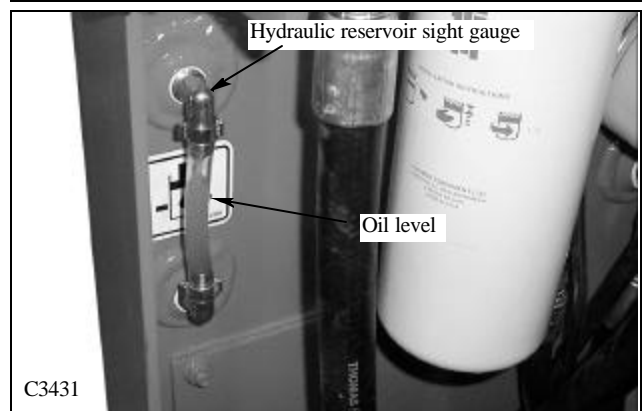
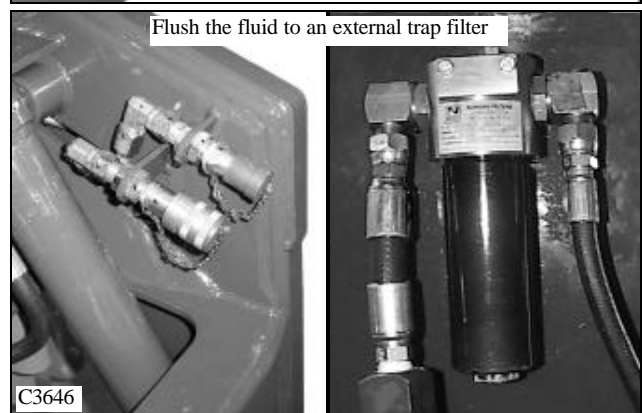
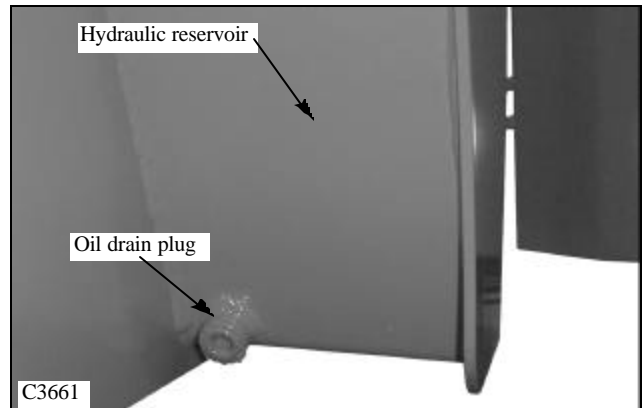

FLUSHING THE HYDRAULIC SYSTEM 2.6

For flushing water from the hydraulic system, perform the following procedures:

- 1 Remove any attachment.
- 2 Make sure all cylinders are fully retracted.

IMPORTANT

Be sure attachments are removed and liftarm are in the lowered position.

- 3 Change the hydraulic fluid. (fig. C3661)
- 4 Change the hydraulic filter. (fig. C3650)
- 5 Disconnect the hydraulic lines from one set of cylinders. (fig. C3601, C3441)
- 6 Start the engine and set to the lowest idle.
- 7 Have someone hold the open hydraulic lines into a container. Stroke the foot pedals, or hand operated, controls slowly. Continue to repeat this cycle until the oil comes out clear. Repeat for opposite set of cylinders.



WARNING

Use caution when dealing with hydraulic fluid under pressure. Escaping fluid under pressure can penetrate the skin and cause serious injury.

- 8 Attach a hose and couplings to the auxiliary circuit. Engage the auxiliary hydraulics, forward and reverse, until the oil flows clear.
- 9 Connect 1 hose each, on each cylinder, to the fixed end of the cylinder barrel.

IMPORTANT

Check the hydraulic oil frequently during this procedure. Replenish as required.

- 10 Move the foot pedal or control lever to extend the cylinder rods. This will flush the oil from inside the cylinder barrels. Be prepared to contain the waste oil.
- 11 Stop the engine.
- 12 Connect the hydraulic hoses to the rod end of the cylinder barrel.
- 13 Replenish the hydraulic oil as required.

IMPORTANT

Please contain and dispose of waste oil in an environmentally friendly manner.

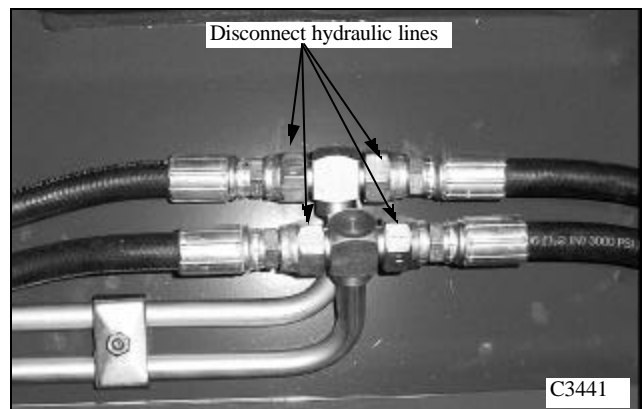
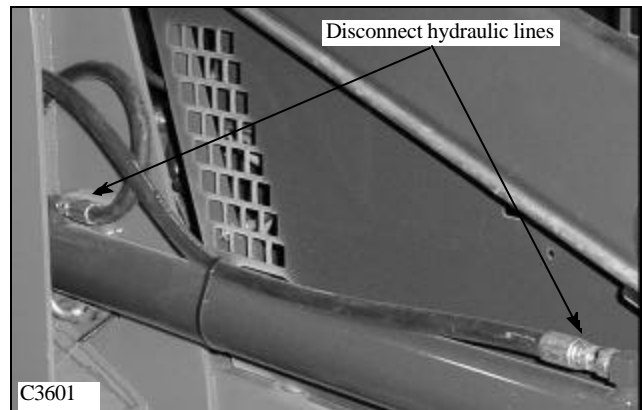
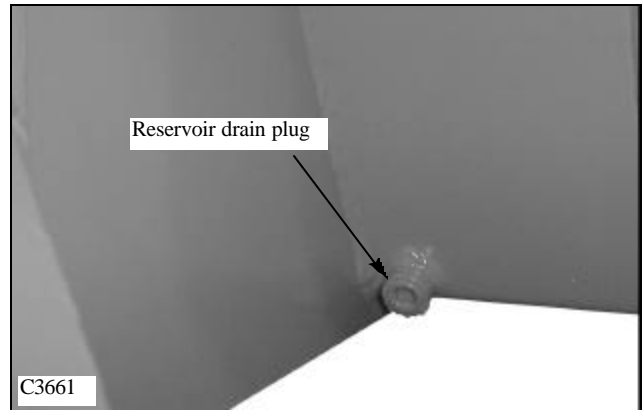

2

START-UP PROCEDURE 2.7

The following start-up procedure should always be adhered to when starting up a new installation or when restarting after pump repairs have been made.

- 1 Fill the hydraulic oil reservoir to the proper level. (fig. C3431)
- 2 The inlet hose from the oil reservoir to the charge should be filled with oil prior to starting.
- 3 Check inlet and pressure hose fittings for proper tightness prior to starting.
- 4 The pump must be filled prior to start-up with filtered oil. Fill the pump by pouring oil into the side case drain port. (fig. C4197 location “D”)



WARNING

This start-up procedure must be made with the loader securely raised off the ground.

- 5 Disconnect the engine stop solenoid wiring, or remove the fuse connected to the red wire. (fig. C3872)
- 6 Turn the engine over by engaging the starter. Repeat this step, turning the engine over in 15 second interval, 5 or 6 times. This will fill the rest of the hydraulic hoses.
- 7 Reconnect the engine stop solenoid or replace the fuse.
- 8 Start the engine and let idle at lowest possible setting.
- 9 Check for leaks and make adjustments as required. Do not use your hands to check for leaks while the engine is operating.
- 10 Replenish the hydraulic oil reservoir as required.
- 11 Start the engine and increase the RPM's to half throttle. Bring the hydraulic fluid up to operating temperature and make control adjustments as outline in Section 4.



WARNING

Use caution when dealing with hydraulic fluid under pressure. Escaping fluid under pressure can penetrate the skin and cause serious injury.

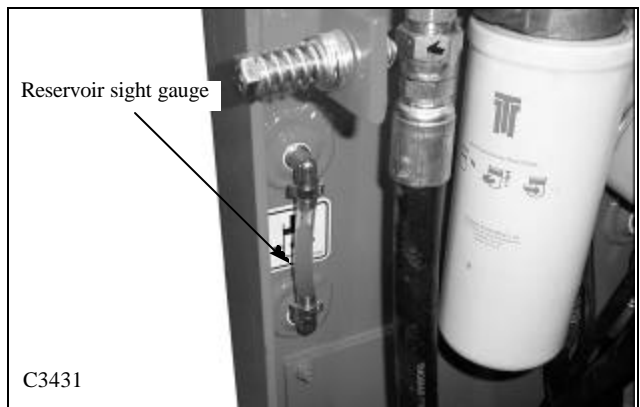
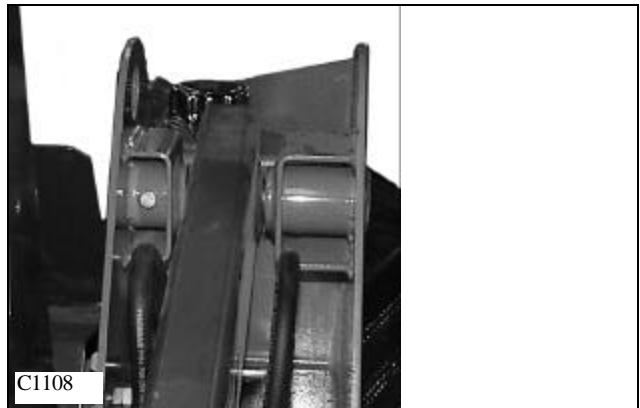
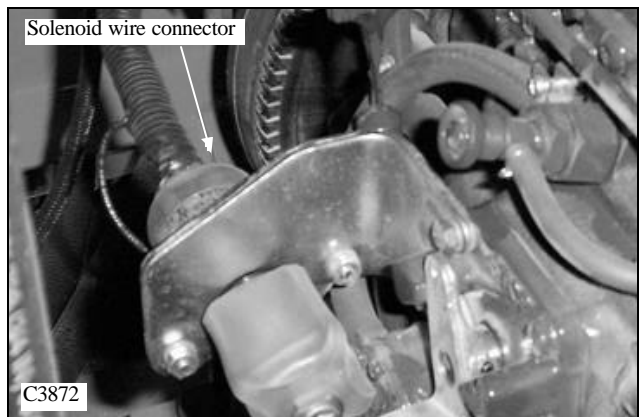
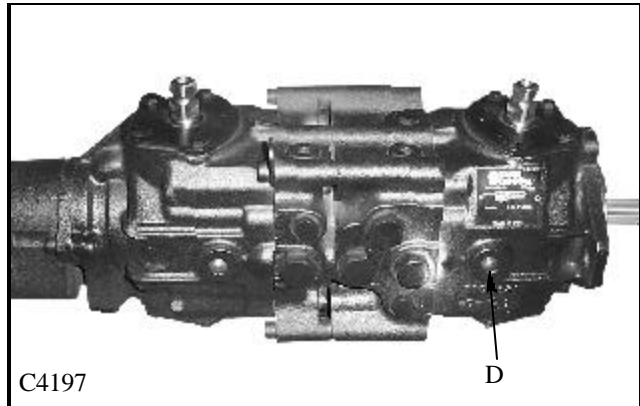

2

GEAR PUMP REPLACEMENT 2.8

Start the gear pump removal procedure by removing any attachment, raising the boom arms and engaging the boom support pins. Shut off the engine.

1 Remove the seat and hydrostatic shield.



WARNING

To prevent personal injury do not work under the boom arms without the boom supports engaged.

2 Attach a vacuum system to the hydraulic oil reservoir filler location. (fig. C3428) Or drain the oil reservoir. Seal the threads on the drain plug, if removed, with teflon tape or a liquid form of pipe sealant before reinstalling.

3 Disconnect the hydraulic hoses from the gear pump. (fig. C3448) Remove the pump fittings. Cap all open hoses to prevent contamination. After capping ends you may unhook vacuum system from oil reservoir.

4 Remove the 2 bolts holding the gear pump to the hydrostatic tandem section. (fig. C3449) Remove the gear pump.

5 Replace gear pump in reverse order.

IMPORTANT

If gear pump replacement is being done because of failure, the hydraulic system and oil should be checked for contamination.

6 If the hydraulic system has been contaminated by pump or other failure you must follow the cleaning procedure outlined in section 2.7.

7 Start the engine and check for leaks. Do not use your hands to find leaks.



WARNING

Use caution when dealing with hydraulic fluid under pressure. Escaping fluid under pressure can penetrate the skin and cause serious injury.

8 Check the fluid level in the hydraulic oil reservoir and replenish as required. (fig. C3431)

IMPORTANT

When making repairs to the hydraulic system, keep the work area and parts clean. Use caps and plugs on all open lines and ports.

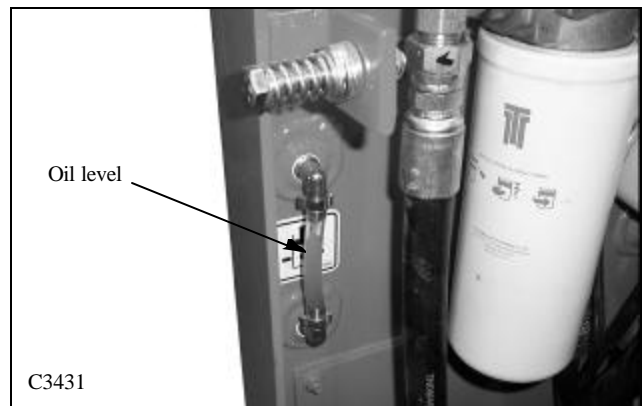
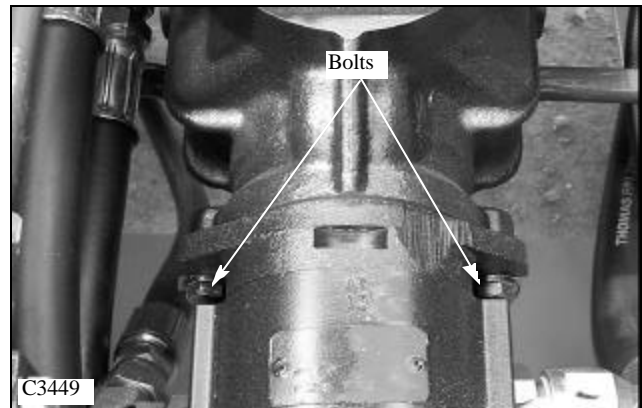
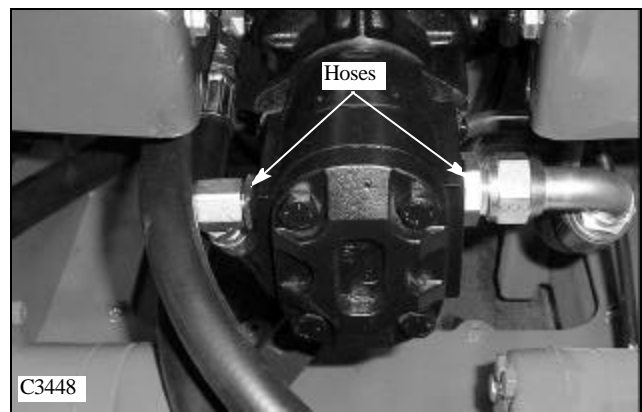

2

TANDEM PUMP REPLACEMENT 2.9

Begin the pump removal by removing any attachment, raise the boom arms and engage the boom support pins.



WARNING

To prevent personal injury do not work under the boom arms without the boom supports engaged.

2

Shut off the engine.

- 1 Remove the seat and hydrostatic shield.
- 2 Remove the steering lever linkage. Refer to section 4 for removal and replacement information.
- 3 Remove the gear pump as outlined in section 2.9.
- 4 Disconnect all the hydraulic hoses. (fig. C3450)

Mark hose and fitting location if necessary to ease re-assembly. Upon re-assembly, torque the hydraulic fittings and hoses as outlined in the Torque Chart in Section 2.13. Cap all open lines and ports.

5 Remove fittings from the tandem pump to prevent damage while removing pump. Plug all open ports and keep the fittings in a clean area. Inspect fittings and o-rings for damage, replace as required.

6 Loosen the forward lower mounting bolt on the tandem pump mounting bracket. (fig. C3451)

7 Remove the 2 bolts on the u-joint access panel (fig. C3453) to gain access to the rear mounting bolts for the tandem pump. Tip the top of the panel rearward and pull the panel forward to remove.

IMPORTANT

When making repairs to the hydraulic system, keep the work area and parts clean. Use caps and plugs on all open lines and ports.

8 Attach a lifting device to the tandem pump. The pump is fairly heavy, approximately 80 lbs. (36 Kg) It is highly recommended to use a mechanical lifting device to assist removal of the tandem pump.

9 Remove the 2 rear mounting bolts by access through the u-joint access panel and remove the front mounting bracket. Remove tandem pump from the loader. (fig. C3452)



CAUTION

To prevent possible personal injury, do not attempt to lift heavy objects without assistance.

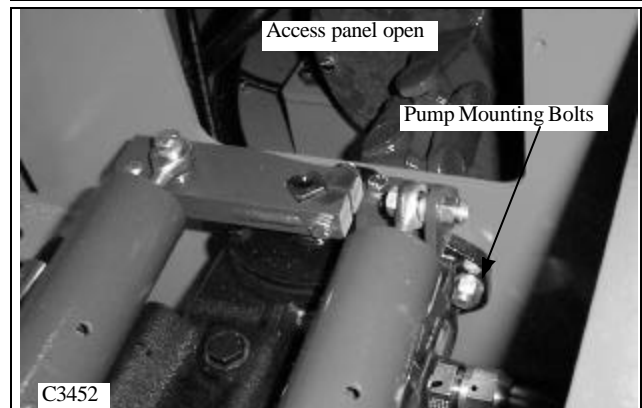
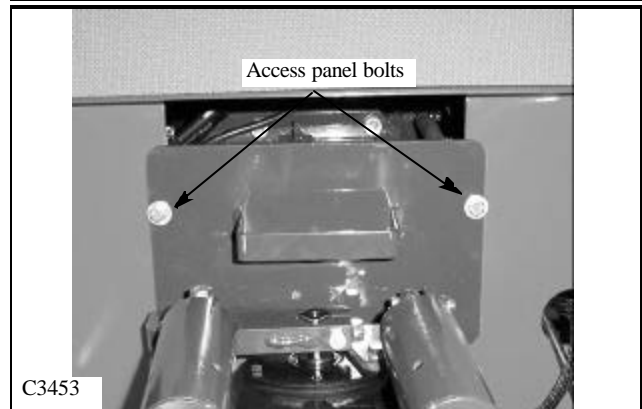
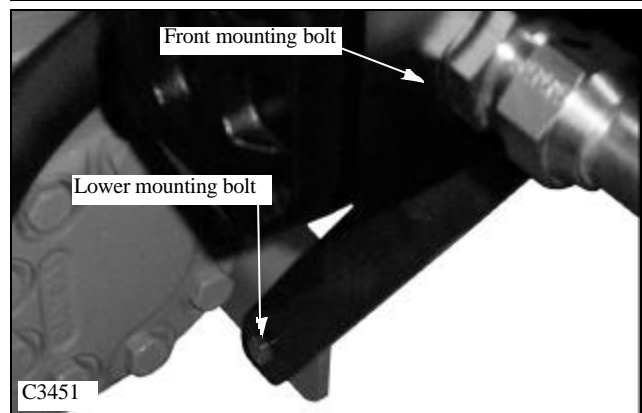
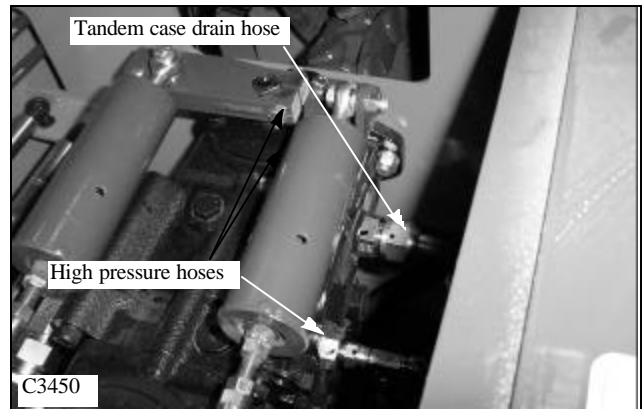

TANDEM PUMP REPLACEMENT 2.9

Upon reassembly, inspect the outside area of the tandem pump housing for damage that may have occurred in transit or handling.

- 1 Attach a lifting device to the tandem pump.
- 2 Install the lower charge pressure inlet fitting to the tandem pump and attach the brake valve hose. (fig. C3478) Follow the torque chart on page 2 - 43.
- 3 Install the tandem pump to the loader.



WARNING

To prevent personal injury, do not attempt to lift heavy objects without assistance.

- 4 Line up the u-joint to the tandem pump input splined shaft as you guide the pump into it's mounting location. (fig. C3479)
- 5 Install the 2 rear mounting bolts.
- 6 Line up the front mounting brace holes and install the bolt. (fig. C3451)
- 7 Torque the 2 rear mounting bolts to 60 ft/lbs. (82 N.m.) Torque the front pump bracket mounting bolt to 50. (68 N.m.) Torque the front lower mounting bracket bolt to 20 to 25 ft/lbs. (32 N.m.) Remove the lifting device.

8 Connecting the 4 high pressure drive hoses and fittings to the tandem pump can only be accomplished in a certain sequence. (fig. C3480) Follow the Torque Chart in Section 2.13, page 2 - 43 when tightening fittings and hoses. If you have removed the hoses completely use the following pattern to reconnect:

- A Hose no. 4 connects to the bottom port of the right hand drive motor.
- B Hose no. 1 connects to the bottom port of the left hand drive motor.
- C Hose no. 2 connects to the top port of the left hand drive motor.
- D. Hose no. 3 connects to the top port of the right hand drive motor.

9 Connect the charge inlet hose from the oil filter to the tandem pump. Torque the fittings and hoses according to the Torque Chart in Section 2.13 page 2 - 43.

IMPORTANT

When making repairs to the hydraulic system, keep the work area and parts clean. Use caps and plugs on all open line and ports

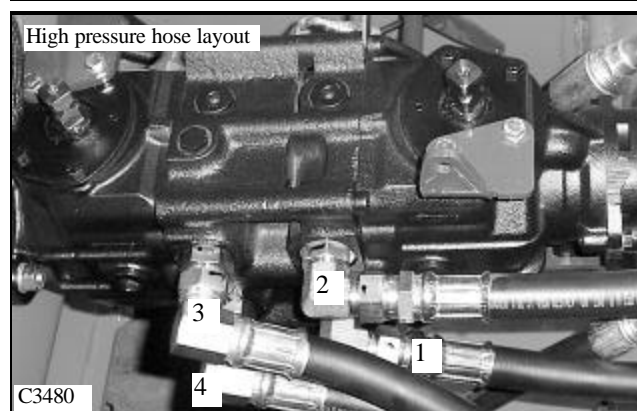
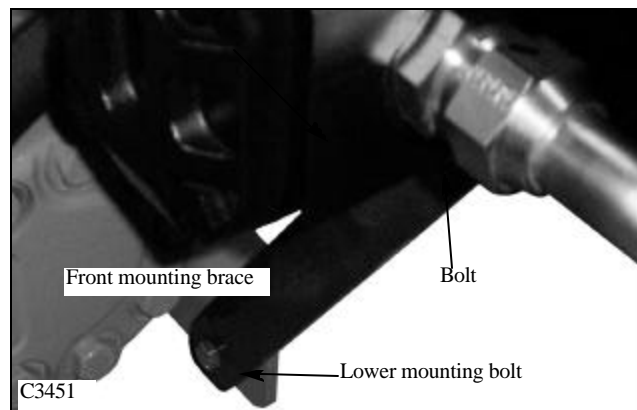
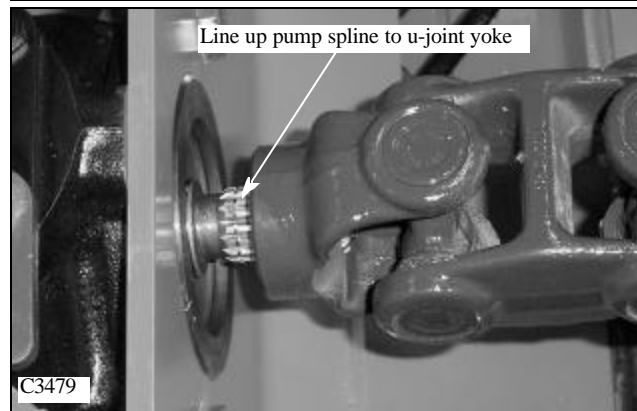
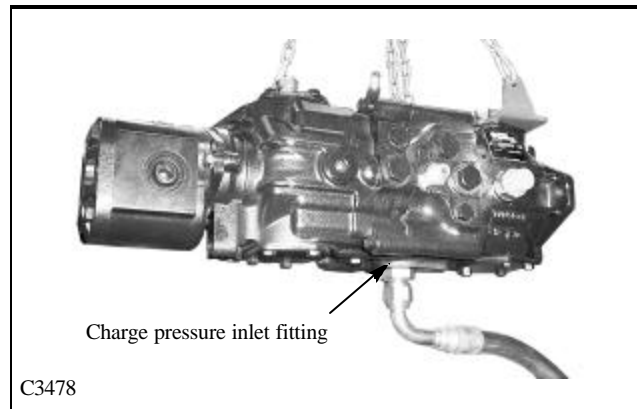

TANDEM PUMP REPLACEMENT 2.9

10 Connect the tandem pump case drain fitting and hose. Torque the fittings and hoses to the specifications listed in the Torque Chart in Section 2.13 page 2 - 43.

2

IMPORTANT

When making repairs to the hydraulic system, keep the work area and parts clean. Use caps and plugs on all open line and ports.

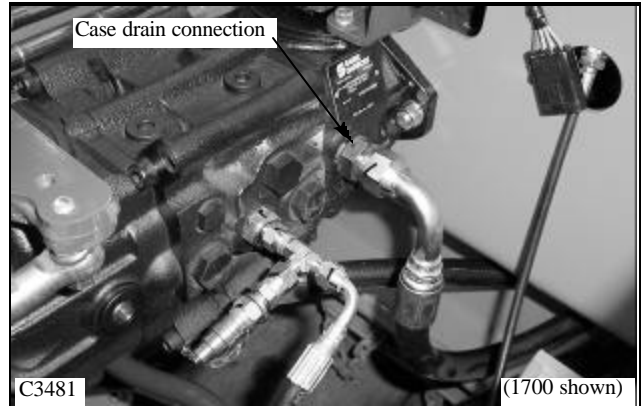

11 Connect the auxiliary gear pump outlet fittings and hoses to the gear pump. (fig. C3482) Follow the Torque Chart in Section 2.13 page 2 - 43 when tightening fittings and hoses.

IMPORTANT

Inspect fitting o-rings and flares for marks or damage. Replace if necessary.

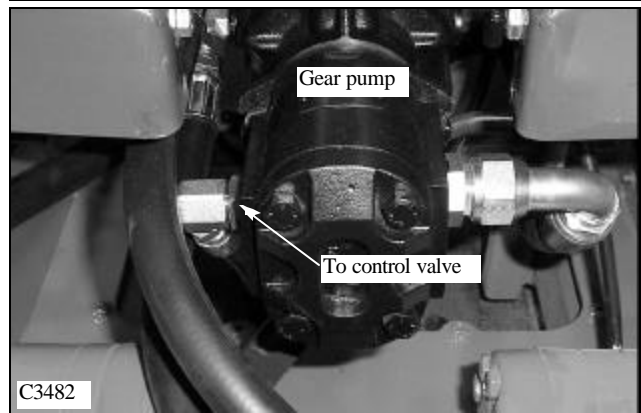

12 Connect the inlet fitting and hose to the auxiliary gear pump. (fig. C3482) Torque the fittings and hoses to the specifications listed in the Torque Chart Section 2.13.

IMPORTANT

Follow the Torque Chart In Section 2.13 when tightening fittings and hoses.

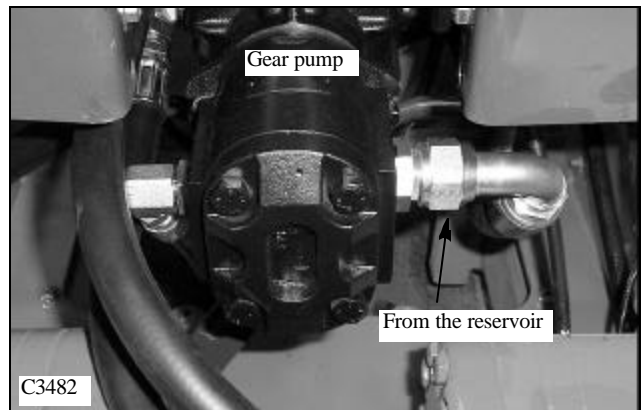

13 Connect the charge pressure outlet line from the tandem pump to the hydraulic brake valve. (fig. C3483)

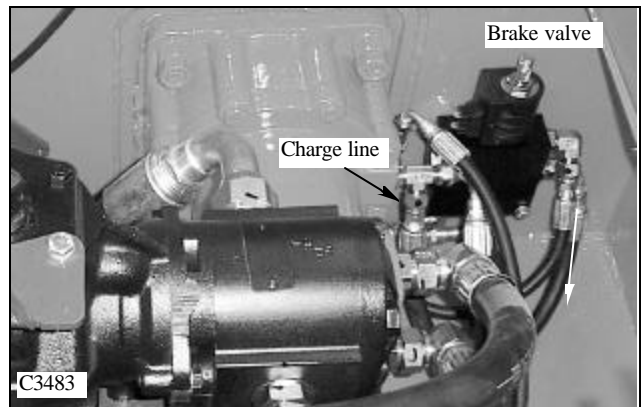

TANDEM PUMP REPLACEMENT 2.9

14 Reinstall the steering control linkages and locks as outlined in Section 4. and install access cover with 2 bolts. (fig. C3485)

IMPORTANT

Follow the start up procedure outlined in section 2.8 upon restarting after pump repairs or replacement.

- 15 Fill the hydraulic oil reservoir to the proper level.
16 Follow the start up procedure outlined in section 2.8 before attempting to start the loader.
17 The start up must be made with the loader raised securely from the ground. Changing the pumps and the steering control linkages has affected the neutral adjustment. Failure to raise the loader clear of the ground may result in the loader engaging in motion and possibly causing serious injury.



WARNING

This start-up procedure must be made with the loader securely raised off the ground.

18 Start the loader and check for leaks. Make repairs as necessary and replenish the hydraulic oil reservoir (fig. C1108, C3431). Never use your hands to check for hydraulic leaks.



WARNING

To prevent personal injury never make repairs to the hydraulic system while the engine is operating.

19 Make adjustments to the steering controls, steering locks, and restraint bar cables as required. Follow the procedures for control adjustments in Section 4



WARNING

Use caution when dealing with hydraulic fluid under pressure. Escaping fluid under pressure can penetrate the skin and cause serious injury.

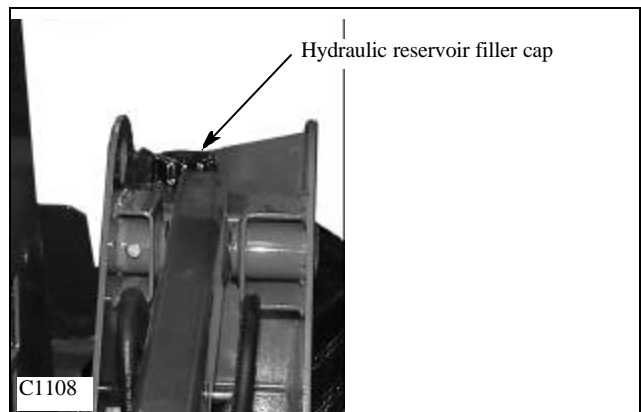
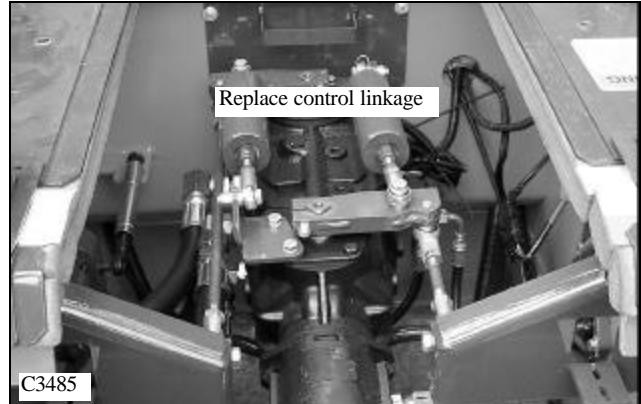

2

— TANDEM PUMP PARTS DIAGRAM 2.10 —

2

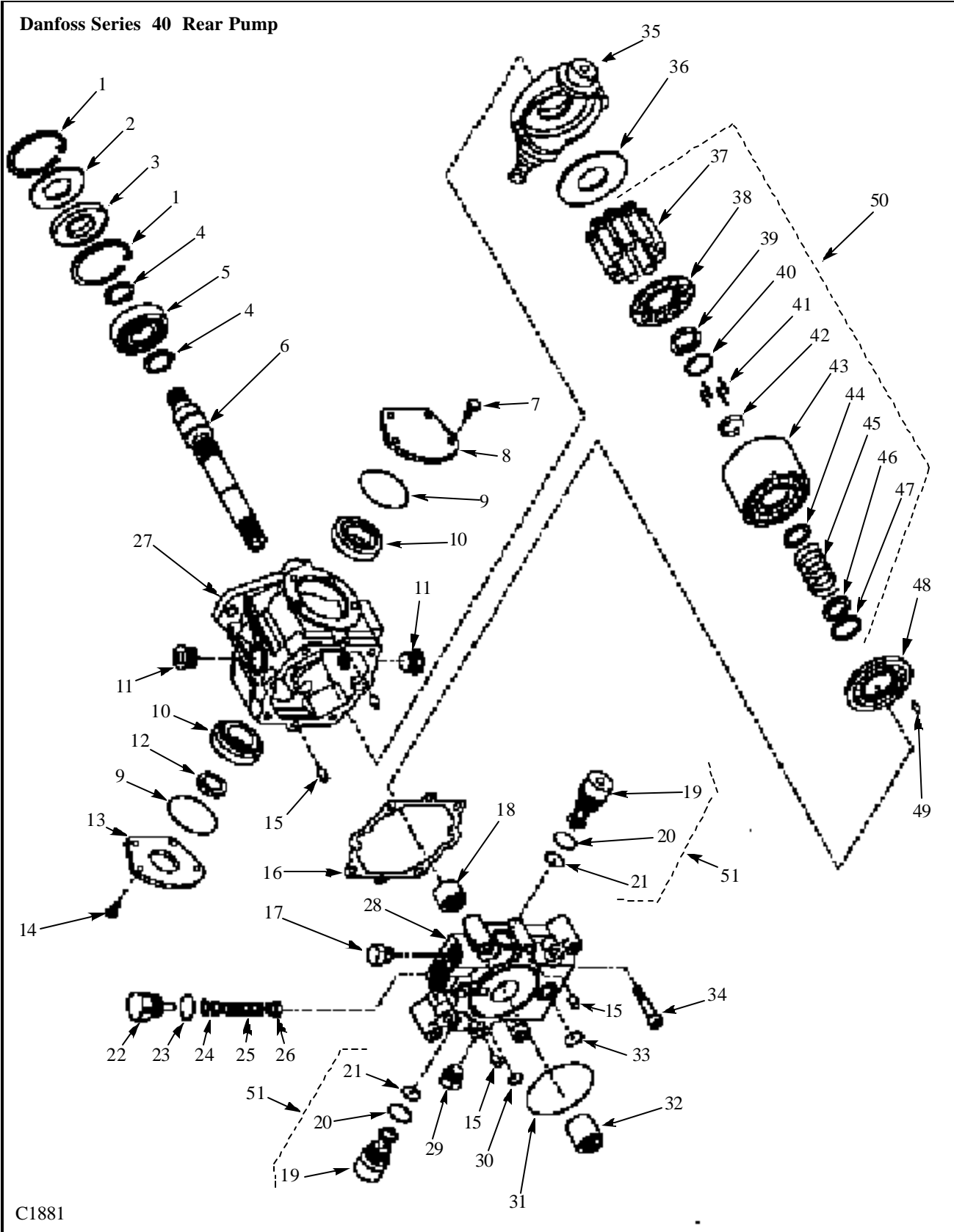

—TANDEM PUMP PARTS DIAGRAM 2.11—

Rear Pump Diagram C1881 Index

1. Retaining ring
2. Seal support washer
3. Input seal
4. Retaining ring
5. Bearing
6. Drive shaft
7. Bolt
8. Cover
9. O-ring seal
10. Bearing
11. Plug
12. Swashplate seal
13. Swashplate cover
14. Bolt
15. Dowel pin
16. Gasket
17. Plug
18. Bearing
19. Relief valve
20. O-ring seal
21. O-ring seal
22. Charge relief plug
23. O-ring seal
24. Charge relief shims
25. Charge relief spring
26. Charge relief poppet
27. Pump housing
28. End cap
29. Plug
30. O-ring seal
31. O-ring seal
32. Coupler
33. O-ring seal
34. Screw
35. Swashplate
36. Thrust plate
37. Piston assembly
38. Slipper retainer
39. Slipper retainer guide
40. Special washer
41. Slipper hold down pins
42. Hold down pin retainer
43. Cylinder block
44. Washer
45. Spring
46. Washer
47. Retaining ring
48. Valve plate
49. Spring pin
50. Cylinder block kit
51. Relief valve kit

**For further service instructions refer to a Sauer
Danfoss Dealer and request a Service / Repair Manual
#BLN 9992**



TANDEM PUMP PARTS DIAGRAM 2.10

2

Danfoss Series 40/ M44 Front Pump

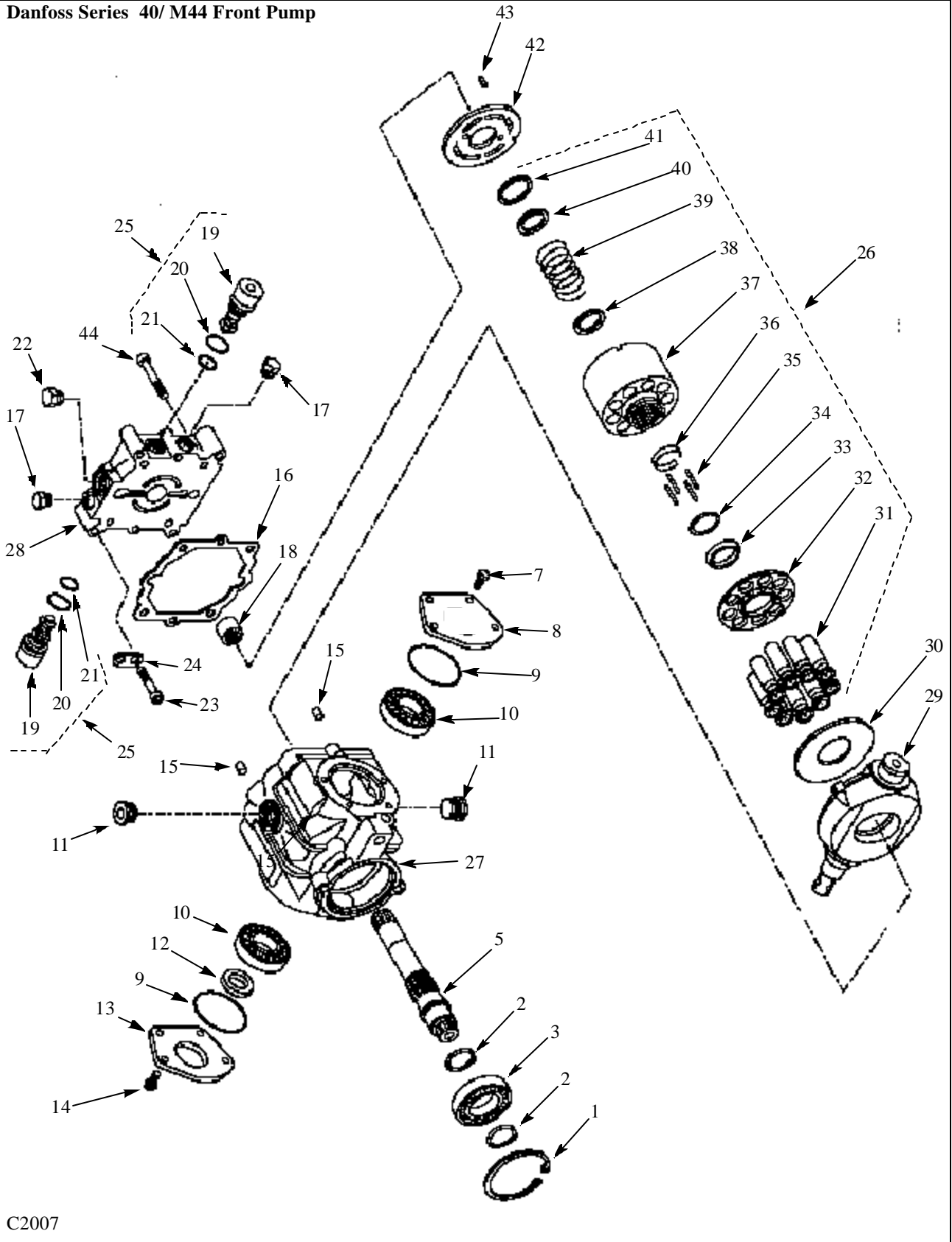

C2007

—TANDEM PUMP PARTS DIAGRAM 2.10—

Front Pump Diagram C2007 Index

1. Retaining ring
2. Seal support washer
3. Input seal
4. Retaining ring
5. Bearing
6. Drive shaft
7. Bolt
8. Cover
9. O-ring seal
10. Bearing
11. Plug
12. Swashplate seal
13. Swashplate cover
14. Bolt
15. Dowel pin
16. Gasket
17. Plug
18. Bearing
19. Relief valve
20. O-ring seal
21. O-ring seal
22. Plug
23. Screw
24. Bracket
25. Relief valve kit
26. Cylinder block kit
27. Pump housing
28. End cap
29. Swashplate
30. Thrust plate
31. Piston assembly
32. Slipper retainer
33. Slipper retainer guide
34. Special washer
35. Slipper hold down pins
36. Hold down pin retainer
37. Cylinder block
38. Washer
39. Spring
40. Washer
41. Retaining ring
42. Valve plate
43. Spring pin

**For further service instructions refer to a Sauer
Danfoss Dealer and request a Service / Repair Manual
#9992**



DRIVE MOTOR 2.11

General Information

2

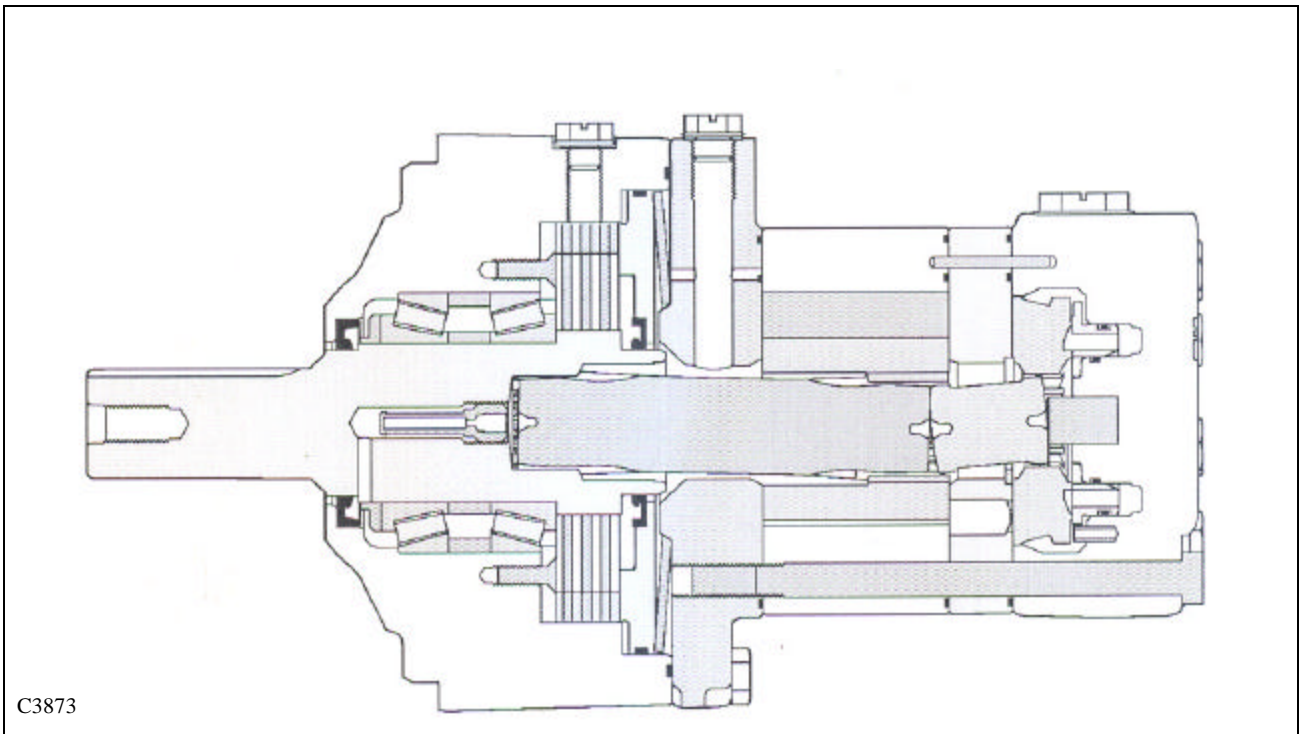

The basic gerotor design uses a combination of mechanical and hydraulic principles that are utilized in the high torque, low speed motors.

The outer ring (fig. C153) of the gerotor assembly is similar to an internal gear that is held in a fixed position by securing it to the motor housing. The rotating inner gear, called a star, orbits inside the secured outer ring.

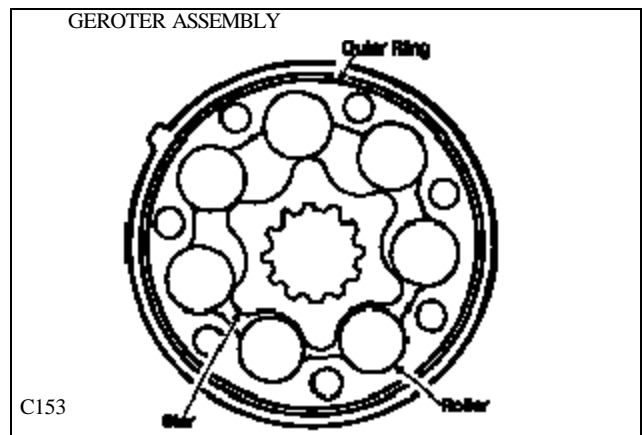

Because of the different number of teeth on the star and outer ring, the star rotates in an eccentric circular orbiting motion from the housing center line. (fig. C154)

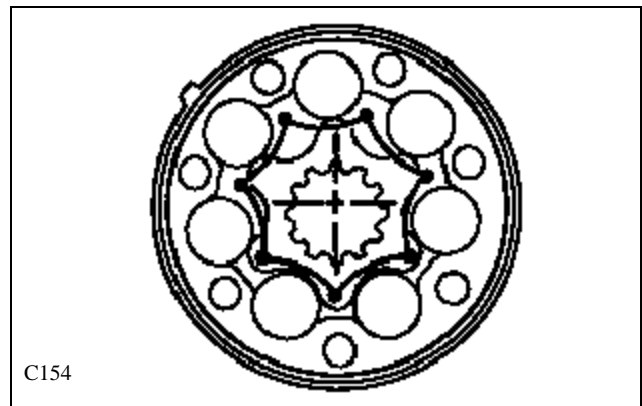

DRIVE MOTOR 2.11

A drive shaft is used to transmit the rotation of the star to the output shaft. The drive shaft has crowned external splines to match the internal splines in the star and output shaft. This type of drive is used because the star center line continuously changes during rotation.

As the star orbits, it causes a continuous opening and closing of the outer ring fluid pockets. Half of these fluid pockets are subject to fluid pressure, causing star rotation, and the opposing half are connected to the return line.

When pressure is introduced into the fluid pockets on the right side of the star (fig. C156) the output rotation will be counterclockwise. When the fluid pockets on the left side of the star are pressurized the output shaft rotation will be clockwise.

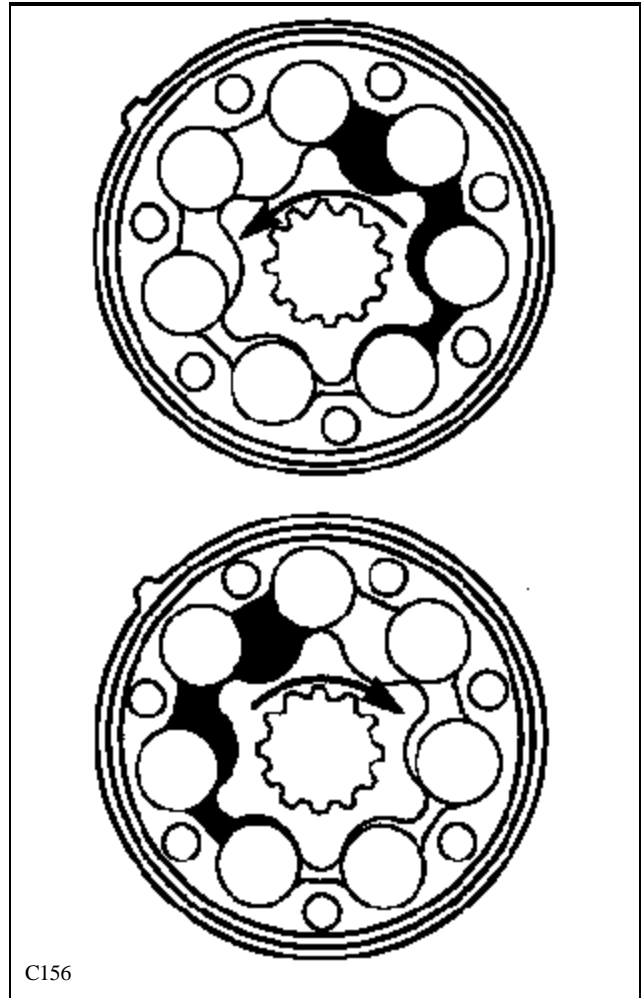

C156

To seal the fluid pockets the torque motor incorporates a rotating roller type seal. (fig. C157) This type of a rolling seal reduces friction at the star points providing increased efficiency and reduced component wear.

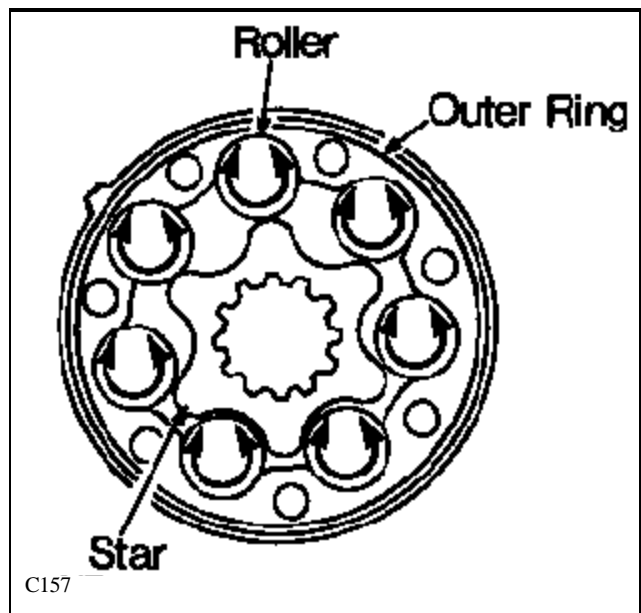

C157

2

DRIVE MOTOR 2.11

The geroter (fig. C3487), is both a fluid displacement motor and a gear reducer. It provides 8 times (the number of star points) greater power per revolution than a gear, vane or piston type motor. This means that 8 times the greater torque can be developed at one eighth the speed without further gear reduction.

2

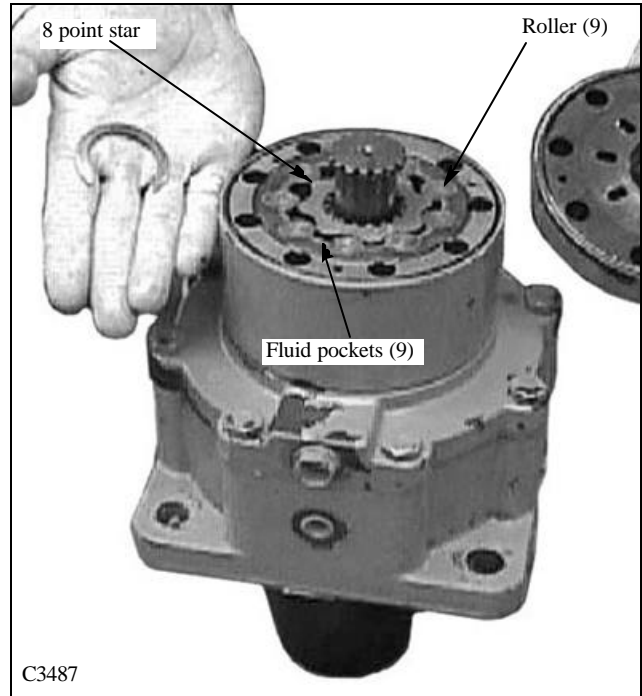

Example shown in fig. C166 is one complete star orbit, or one sixth of the output shaft rotation. The star must travel through 6 complete orbits for each single rotation of the output shaft creating a speed reduction of 6 to 1. The use of 7 fluid power pockets with the 6 to 1 ratio provides 42 fluid power cycles per each complete shaft revolution. **NOTE: Actual star point count is 8. This is only an example.**

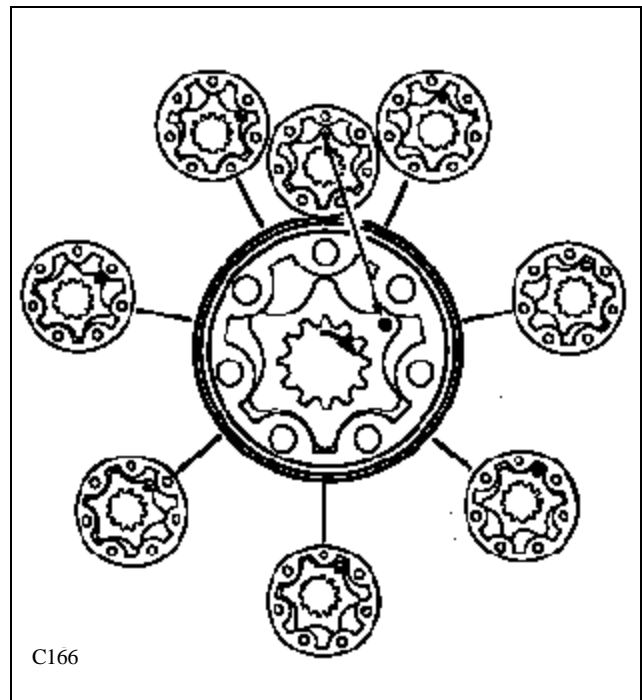

DRIVE MOTOR 2.11

For smooth and continuous motor output rotation, the torque motor utilizes a disc valve which operates in synchronization with the geroler star. The disc valve arrangement consist of a stationary balance plate, rotating disc valve and a stationary valve plate.

The disc valve contains an inlet fluid passage port for each star valley and a return fluid passage point.

A separate crowned driveshaft is used to synchronize the disc valve and the geroler star so that they turn as one. To accept fluid from the disc valve, the valve plate also contains internal porting passages to each outer ring pocket area.

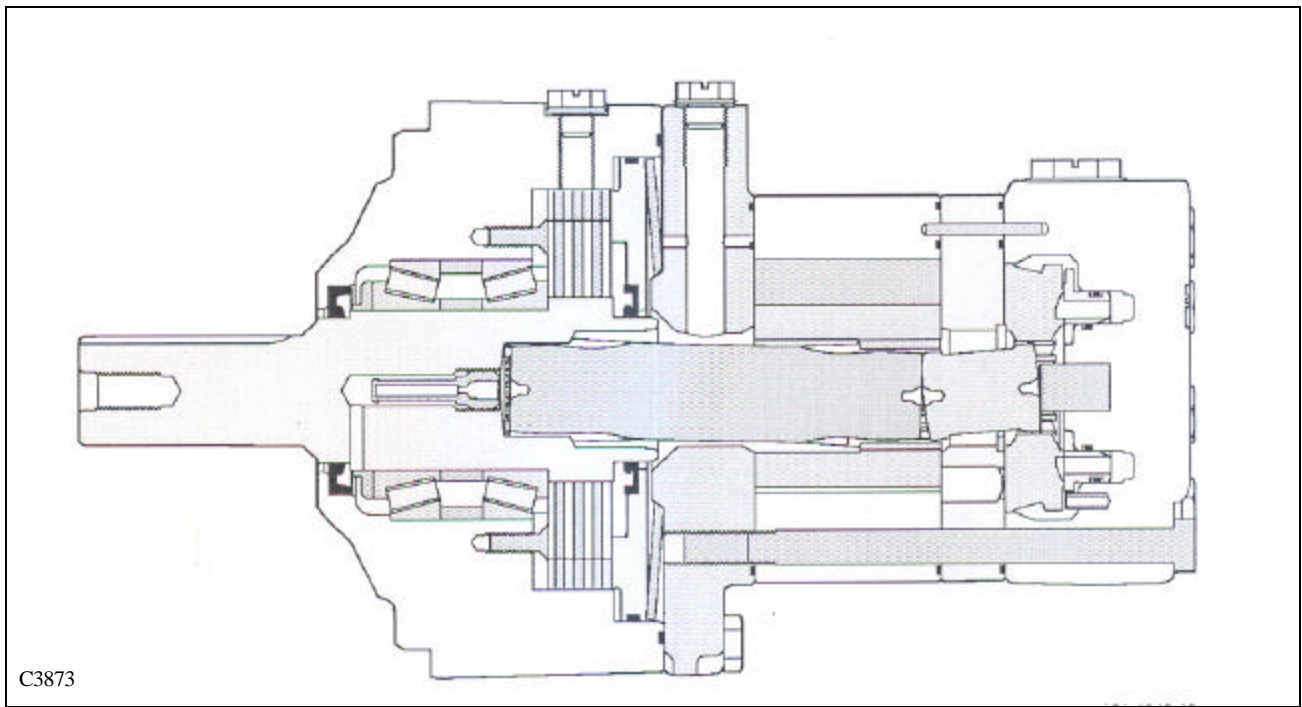
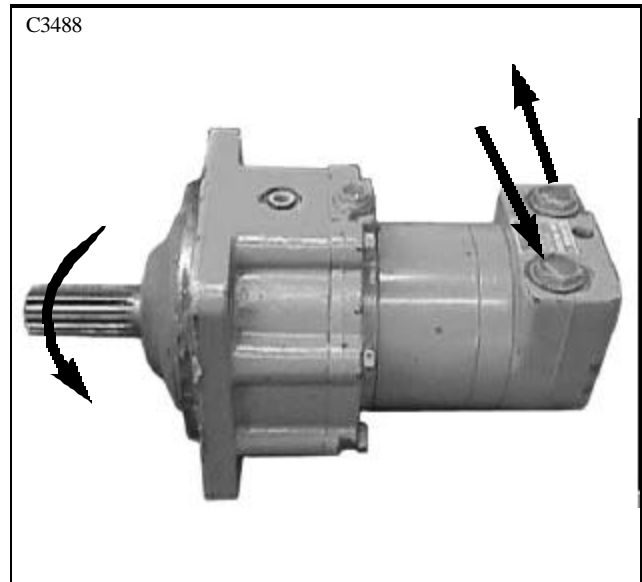

Fluid enters the housing through the inlet port and is directed to the balance plate. The balance ring contains an inner and outer seal to separate the high and low pressure fluid passages. Fluid passes through the stationary balance plate to the rotating disc valve. The rotating disc valve ports the fluid to the stationary valve plate and the proper side of the geroter pockets causing the rotor star to turn.

As the rotor star rotates, and each fluid pocket reaches its full open position, the return porting in the rotating disc

valve opens to allow the fluid in the pocket area to pass back through the valve plate, disc valve, balance plate and out through the housing return port, as the pocket closes.

The disc valve is timed to the gerotor rotor star to govern the the inlet fluid flow to the output shaft rotation. If the timing of the disc valve to the gerotor star is off one tooth, the relationship of input fluid flow to output motor shaft rotation will be reversed.

DRIVE MOTOR 2.11

Removal

2

- 1 Remove any attachment, raise the boom arms and engage the boom support pins.
- 2 Raise the loader securely off the ground.
- 3 Remove the wheels on the side to be repaired.
- 4 Drain the oil from the final drive housing. Be prepared to contain approximately 17 litres (4.5 gal) of fluid. (fig. C1888)



WARNING

To prevent personal injury do not work under the boom arms without the boom supports engaged.

- 5 Remove the seat and hydrostatic shield.
- 6 Remove the final drive inspection cover located between the axles of the final drive housing.(fig. C3489)
- 7 Disconnect the chain as outlined in Section 3.

- 8 Remove the 2 high pressure hoses from the drive motor. (fig. C3490) Cap the open hose ends and fittings to prevent contamination.

IMPORTANT

When making repairs to the hydraulic system, keep the work area and parts clean. Use caps and plugs on all open line and ports.

- 9 Disconnect the 2 brake line hoses and cap the hoses and adapter fittings in the drive motor. (fig. C3490)
- 10 Remove the adapter fittings from the drive motor. Plug the open ports in the drive motor to prevent contamination.

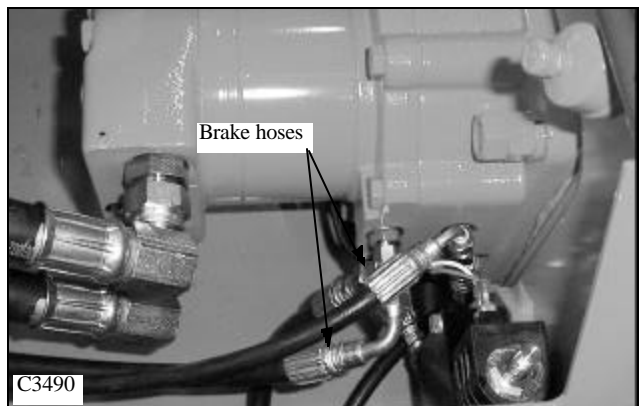
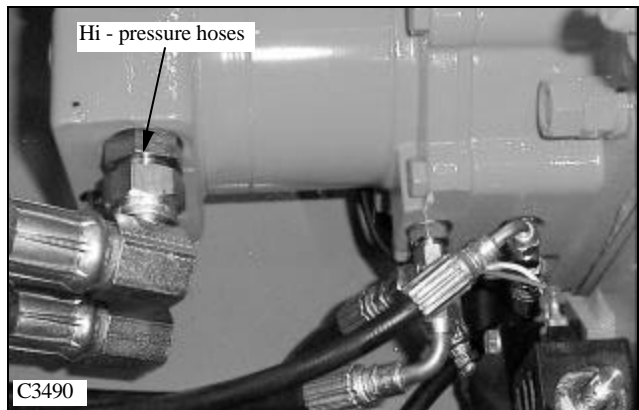
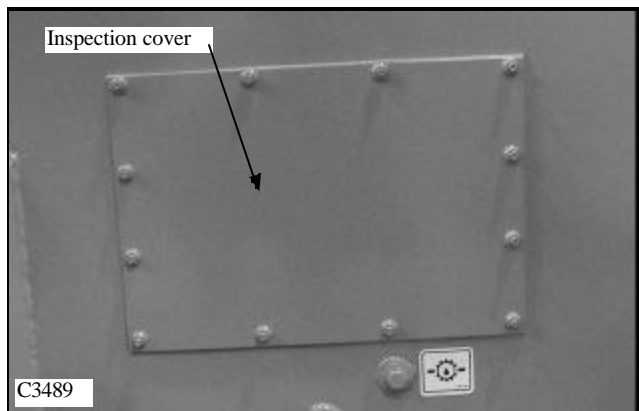
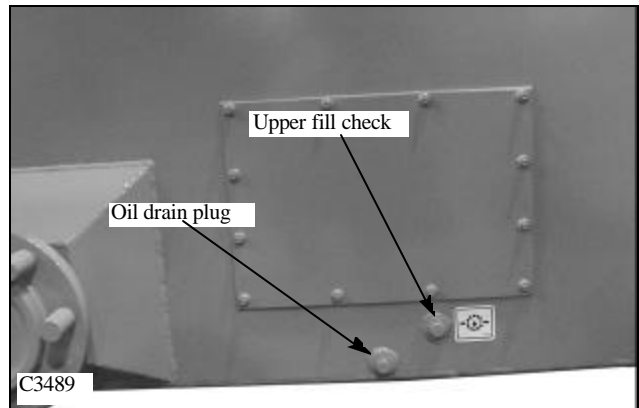

DRIVE MOTOR 2.11

Removal

12 Remove the jam nuts, mounting nuts and lock washers from the 4 mounting bolts retaining the drive motor to the final drive housing. (fig. C3491) Hold the head of the bolts from inside the final drive housing. (fig. C3492)

13 Remove the drive motor. Seal the drive motor with silicone upon reassembly.

14 Upon reassembly torque the 4 mounting nuts to 80 lbs / ft.

15 If the drive motor replacement is being performed because of major parts failure, such as geroter damage, the hydraulic system must be checked for contamination and flushed if necessary as outlined in Section 2.7.

16 If you are installing a new drive motor, remove the drive motor sprocket and bolt if you wish to reuse the sprocket. (fig. C3493)

17 Install the sprocket, machined washer, lock washer and bolt. Apply Loctite 242 (blue) to the threads of the bolt before torquing (fig. C3767) and torque the bolt to 40 lbs / ft. (54 nm).

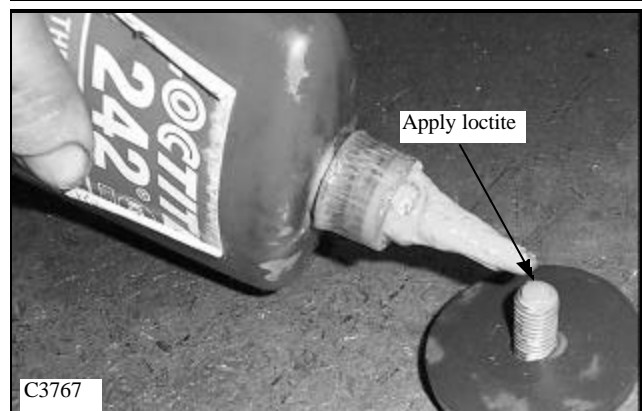
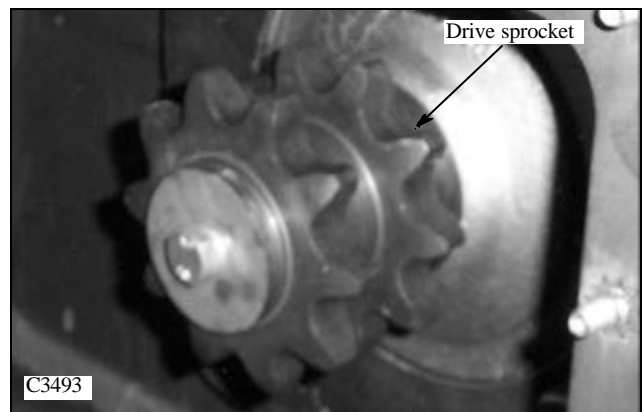
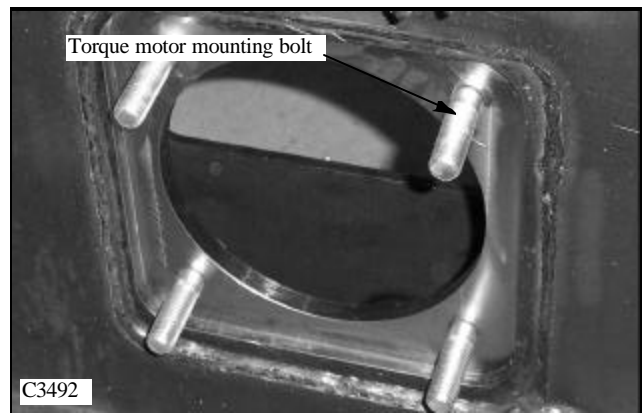
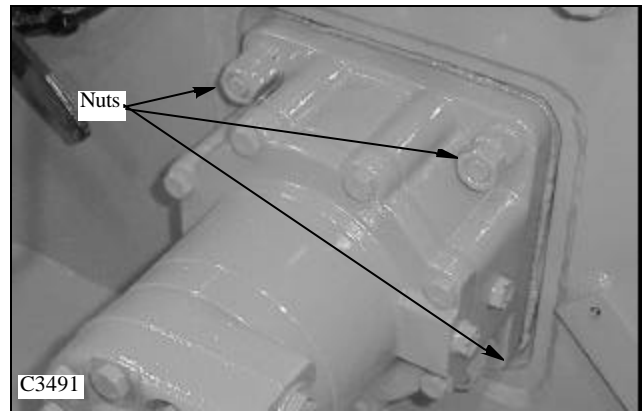

2

DRIVE MOTOR 2.11

Replacement

1 Clean the mounting areas thoroughly that need to be sealed with silicone. (fig. C3494, C3495)

2

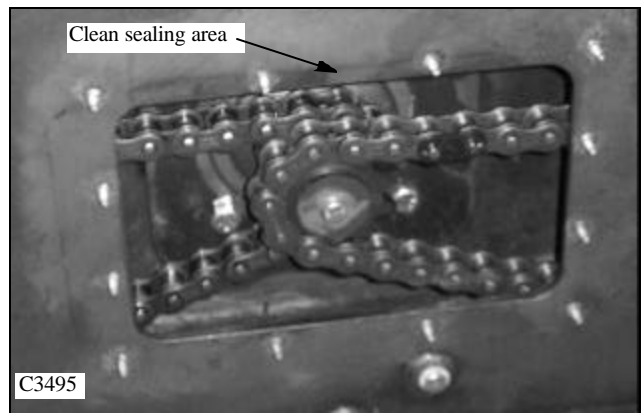
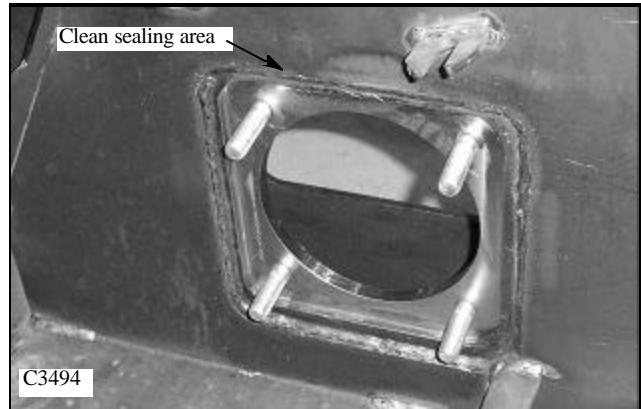

2 Apply a bead 1/4 of an inch thick around the drive motor bearing retainer and around each mounting hole. (fig. C3667)

3 Install the drive motor and sprocket assembly to the final drive housing.

4 Install the 4 bolts, lockwashers and mounting nuts and torque to 80 lbs / ft. (115 nm.)

5 Install the 4 jam nuts. Torque the jam nuts to 40 ~ 60 lbs / ft. (54 ~ 81 nm.)

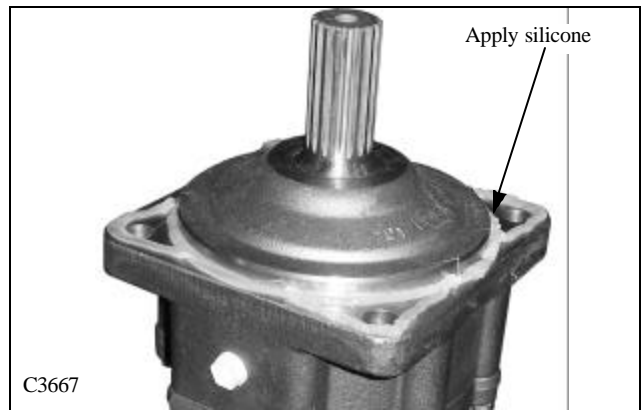

6 Replace the master link in the dive chain. Section 3. shows chain replacement procedure.

7 Add oil to the final drive housing until it trickles out the upper check plug hole. This will require approximately 17 litres (4.5 gal) of 10w30 API SJ (fig. C3496)

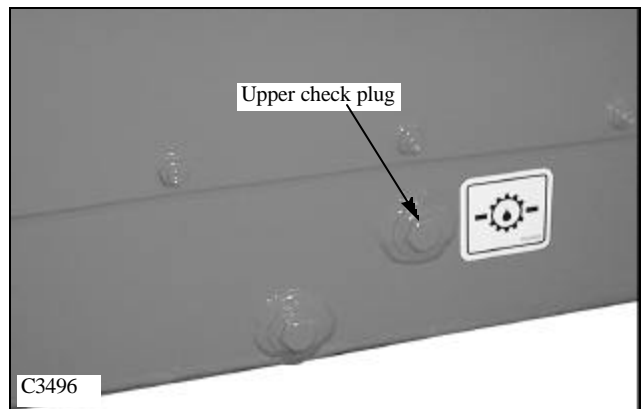

DRIVE MOTOR 2.11

IMPORTANT

Refer to the torque chart in Section 2.13 when tightening hydraulic hoses and fittings

IMPORTANT

Inspect fitting o-rings and flares for marks or damage. Replace if necessary.

- 8 Install the adapter fittings to the drive motor.
- 9 Install the brake lines to the drive motor. (fig. C3490)



WARNING

Use caution when dealing with hydraulic fluid under pressure. Escaping fluid under pressure can penetrate the skin and cause serious injury.

- 10 Install the high pressure drive hoses. (fig. C3490)
- 11 Clean the final drive housing and inspection cover thoroughly before applying silicone sealant. (fig. C3495)
- 12 Install the inspection cover. When installing the nuts, do not over tighten. The mounting torque should not exceed 11 lbs / ft. (15 N.m.)
- 14 Start the engine and check for hydraulic leaks. Do not use your hands to trace hydraulic leaks. Shut off the engine and inspect each fitting for proper torque.



WARNING

To prevent personal injury never make repairs to the hydraulic system while the engine is operating.

- 15 Install the wheels and torque the nuts at 100 to 110 lbs / ft. (136 to 149 nm.)(fig. C3497)
- 16 Install shields and seat, let loader down to ground and test drive to check performance.

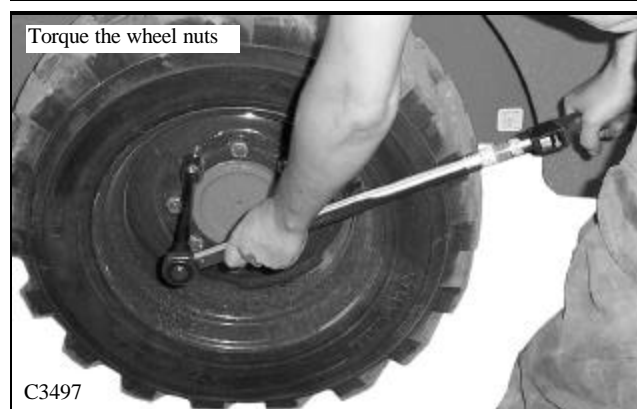
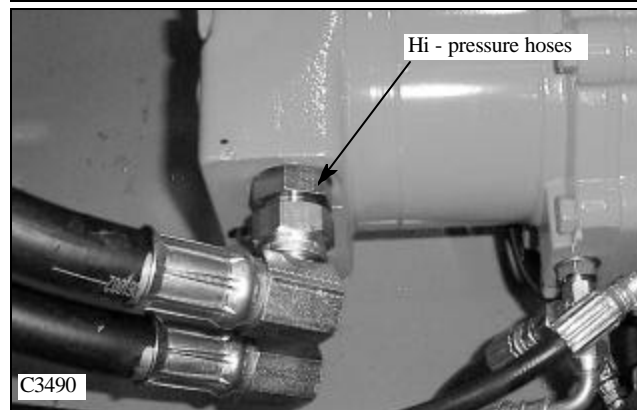
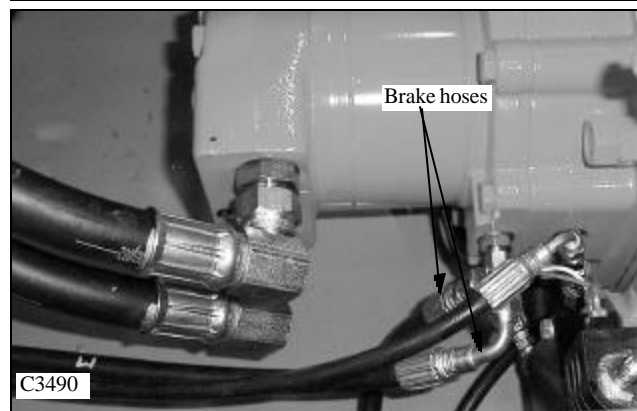
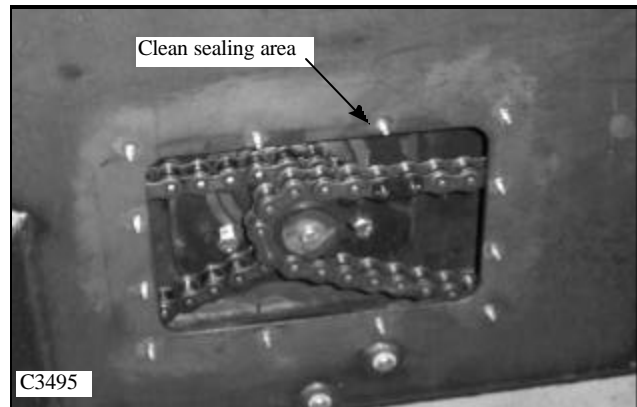

2

DRIVE MOTOR 2.12

Parts Illustration

2

TMT 500 FLV

C4168

1. Bolts
2. End Cover
3. Flushing Spool
4. Name Plate
5. Spacer
6. Springs
7. Restrictor
8. Spring Washer
9. O Ring
10. O Ring
11. Ring
12. Balance Plate
13. O Ring
14. Disk Valve
15. Retaining Ring
16. Valve Drive shaft
17. Channel Plate
18. Guide Pins
19. O Ring
20. Gear Wheel
21. Carbon Shaft

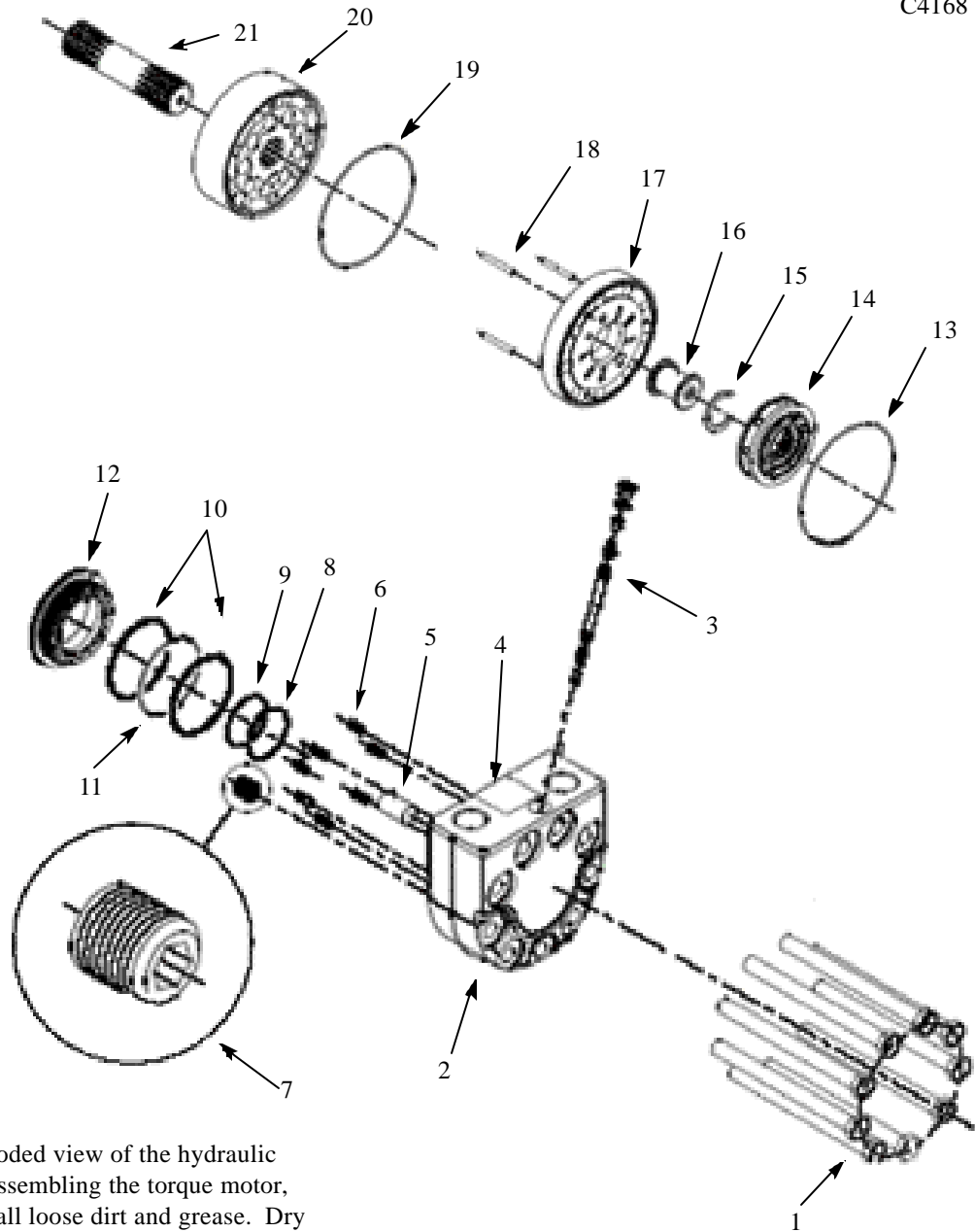

Fig. C4168 shows an exploded view of the hydraulic torque motor. Before disassembling the torque motor, clean the outer surface of all loose dirt and grease. Dry with compressed air. Be sure all openings are plugged to prevent dirt from entering the torque motor.



WARNING

To avoid eye injury, use safety goggles when cleaning with compressed air.

IMPORTANT

When making repairs to the hydraulic system, keep the work area and parts clean. Use caps and plugs on all open line and ports.

DRIVE MOTOR 2.12

Parts Illustration

C4169

TMT 500 FLV

1. Screws
2. O Ring
3. Bearing Housing
4. Spring Plate
5. Piston
6. O Ring
7. Spacer Disc
8. Shaft Bearing Retainer
9. Screws
10. Outer Brake Disc
11. Inner Brake Disc
12. Screw
13. Bearing
14. Splined shaft
15. O ring
16. Screws
17. Retaining ring
18. Shaft Seal
19. Bearing Housing

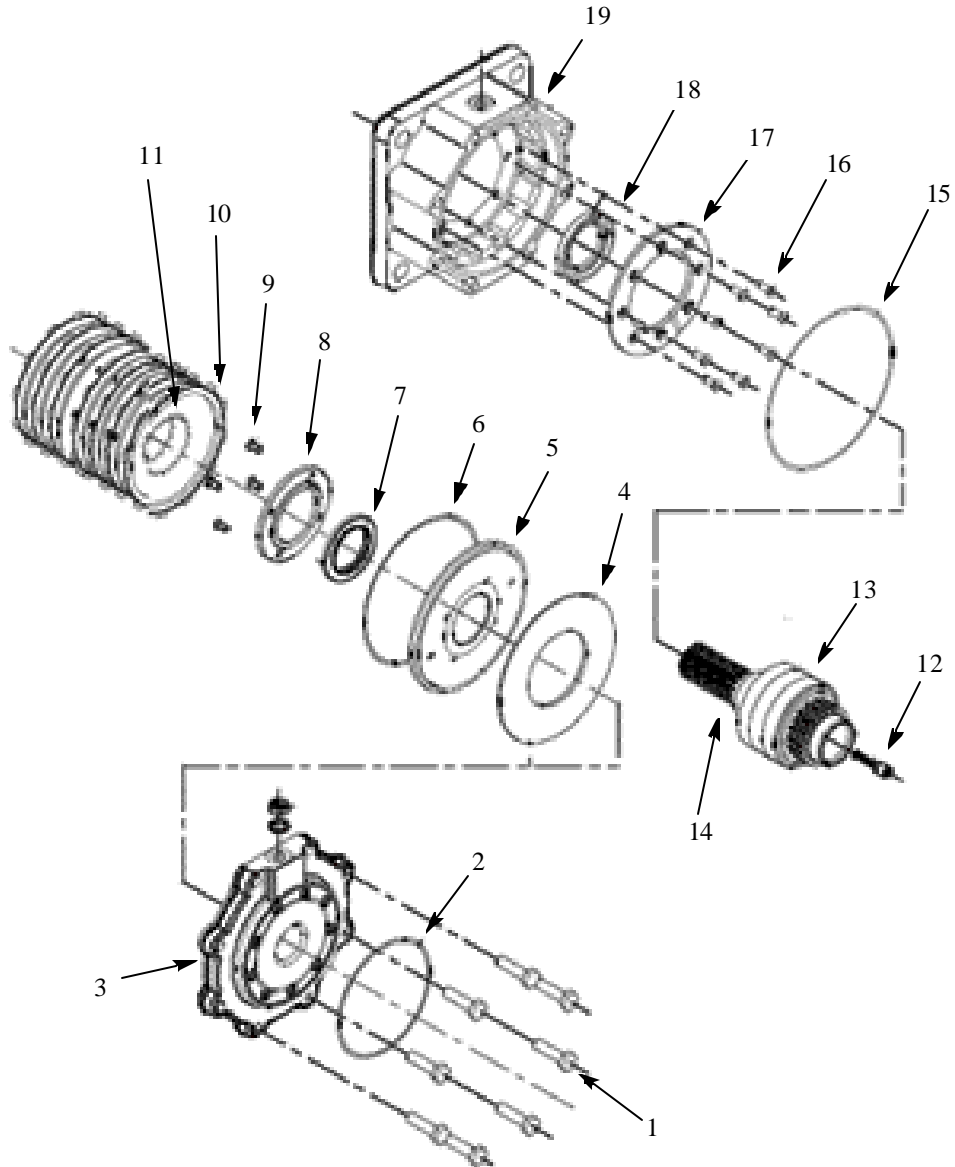

WARNING

To avoid eye injury, use safety goggles when cleaning with compressed air.

IMPORTANT

When making repairs to the hydraulic system, keep the work area and parts clean. Use caps and plugs on all open line and ports.

DRIVE MOTOR 2.11

Disassembly

1 Stand unit on end and use a collar or vice to support shaft. (fig. C3505)

2

2 Alternate the removal of each bolt (9) as the balance plate will un-spring when the final bolt is removed. (fig. C3506)

3 Lift off the end cover and note that the spacer may still be in the balance plate or on top of the drive shaft. (fig. C3507)

4 On a metal surface, hit the valve housing on the side to release the balance plate and springs. (fig. C3508)



C3505



C3506

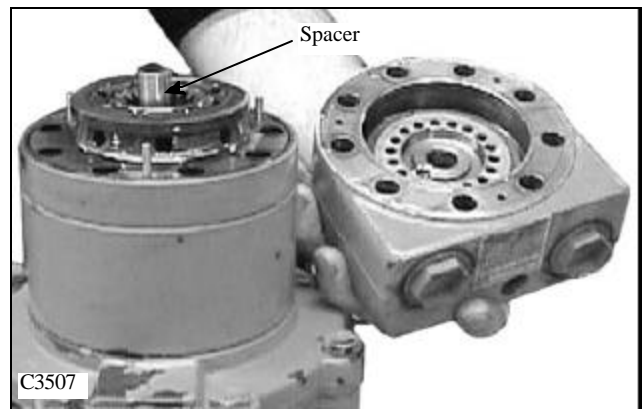

C3507



C3508

DRIVE MOTOR 2.11

Disassembly (cont'd)

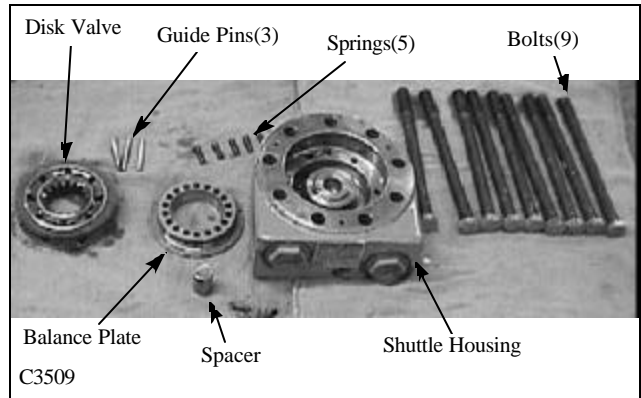

5 Use a 6mm Allen key to remove the flushing valve plug. (fig. C3510)

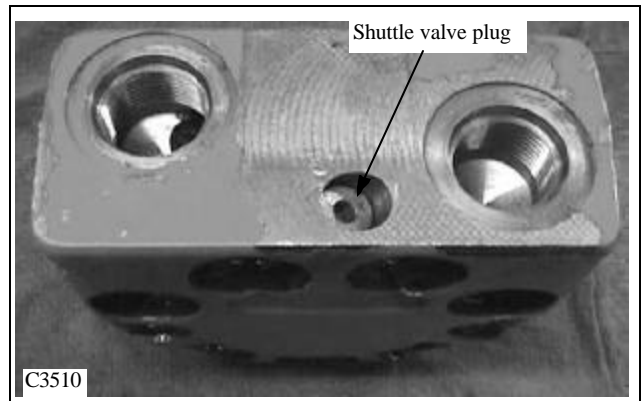

6 Below the plug, the spring guide and the spring are easily removed. (fig. C3511)

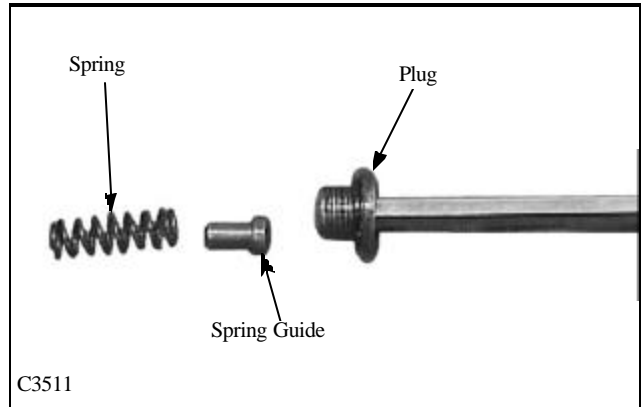

7 The flushing spool is deep within the housing and is very difficult to remove with a magnet. A pair of long thin pliers works much better. (fig. C3512)

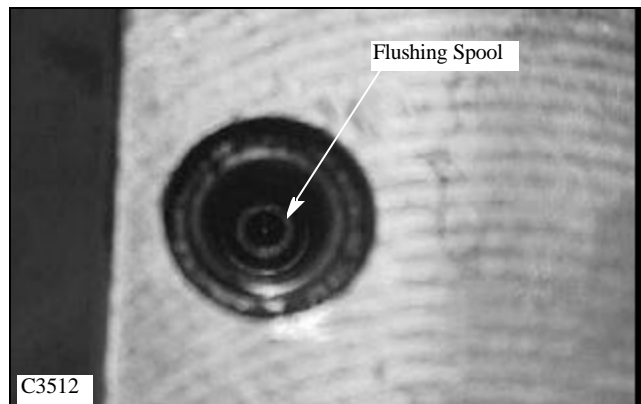

2

DRIVE MOTOR 2.11

Disassembly (cont'd)

8 Carefully remove spool from the housing to avoid scoring. (fig. C3513)

2

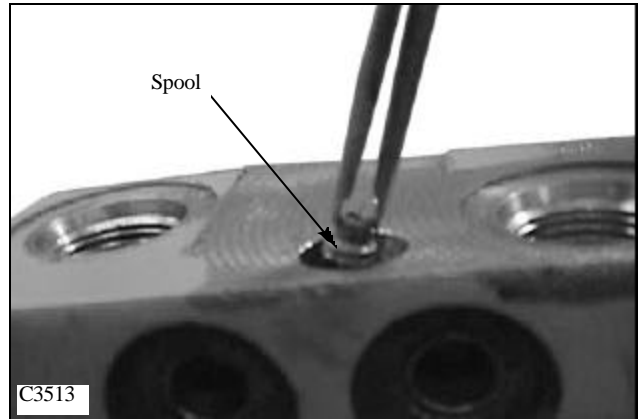

9 Remember that the spool is set at an angle within the housing. (fig. C3514)

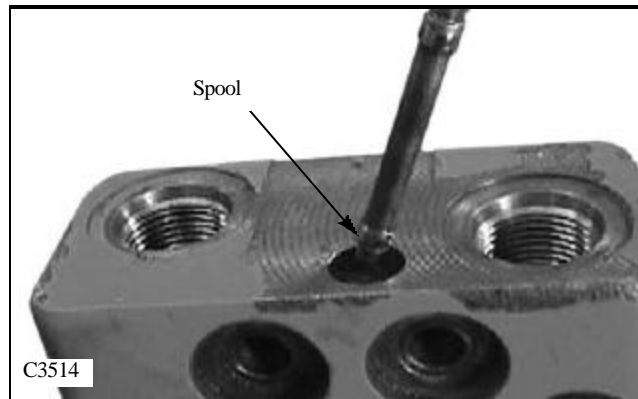

10 The second spring is deep within the housing. It is not necessary to remove this spring unless it is suspected of failure. (fig. C3515)

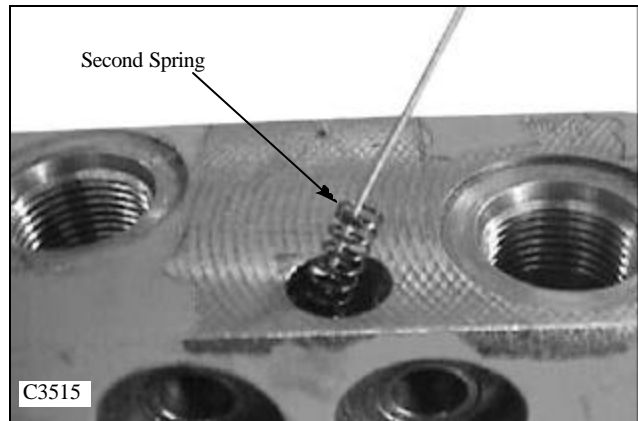

11 The complete flushing valve assembly. Carefully examine prior to reinstalling into housing. (fig. C3516)

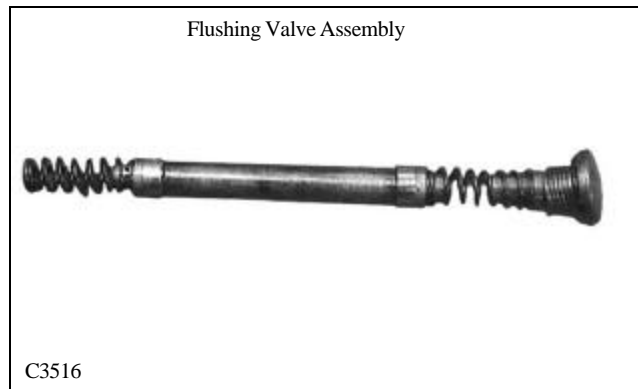

DRIVE MOTOR 2.11

Disassembly (cont'd)

12 Remove the retaining ring, then the channel plate, and then lift off the drive shaft which will then expose the gearwheel and the Cardon shaft. (fig. C3518)

13 With the drive section removed, loosen the eight (8) brake cover screws and lift off the housing to expose the "spring" plate. (fig. C3525, C3526)

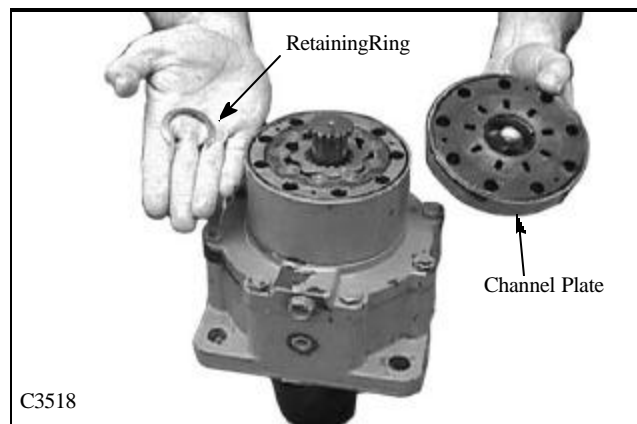
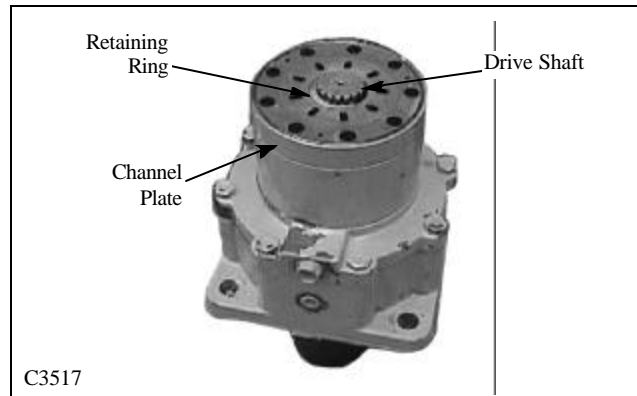

2

DRIVE MOTOR 2.11

Disassembly (cont'd)

14 With the piston removed, the unit can be turned upside-down to remove the excess oil and the brake disks (inner and outer). (fig. C3527)

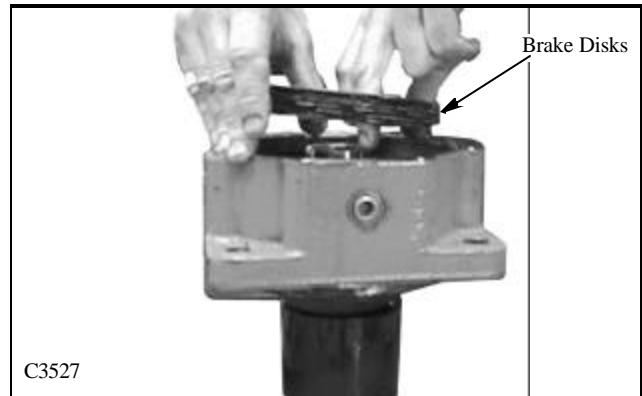

15 With the brake disks removed it exposes the shaft bearing retainer. Remove the eight (8) screws with a Torx driver. (fig. C3528)

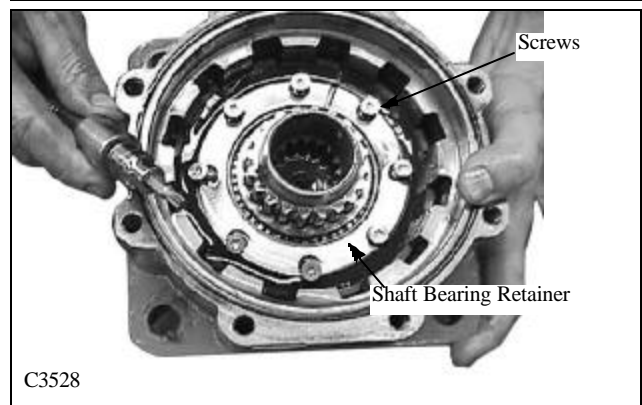

16 Turn the bearing housing and shaft upside-down and hammer out the output shaft. (fig. C3529)



17 At this point the shaft should drop straight downwards. The shaft seal can now be removed and replaced. It can not be removed in any other way. (fig. C3530)

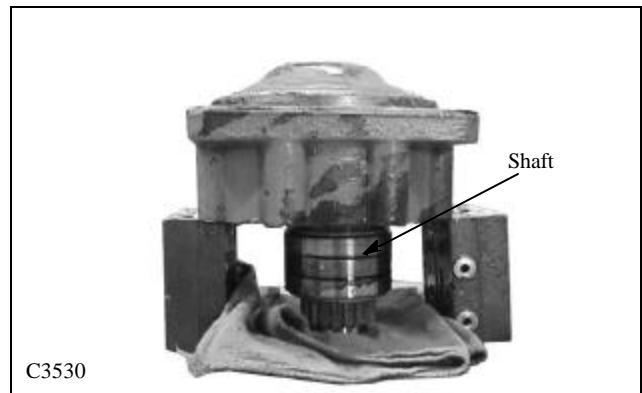

2

DRIVE MOTOR 2.11

Disassembly (cont'd)

18 Complete disassembled unit. (fig. C3531)

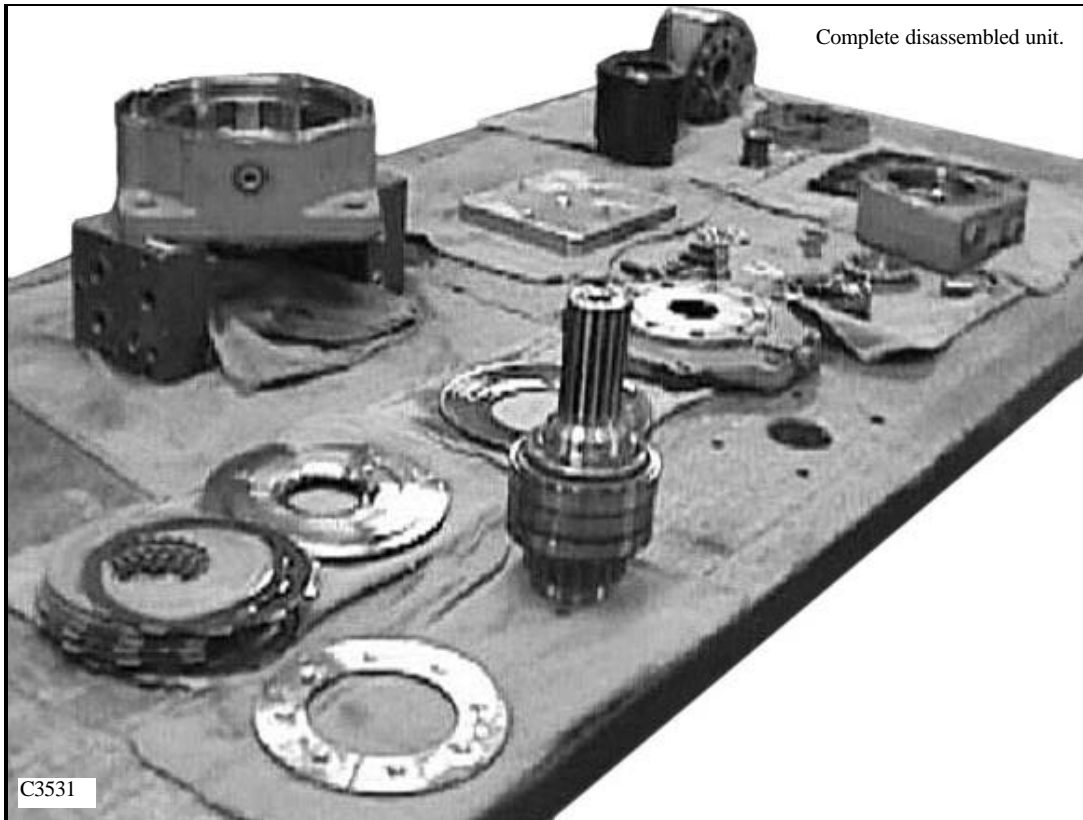

2

DRIVE MOTOR 2.11

Assembly

2

1 The re-assembly of the motor is done opposite of the disassembly. Support the housing and install the output shaft and bearing assembly. (fig. C3532).

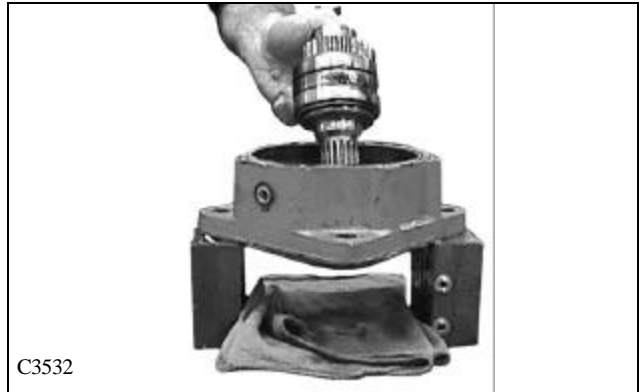

2 Install bearing retaining ring and tighten with Torx drive to 7ft/lbs. (fig. C3533)

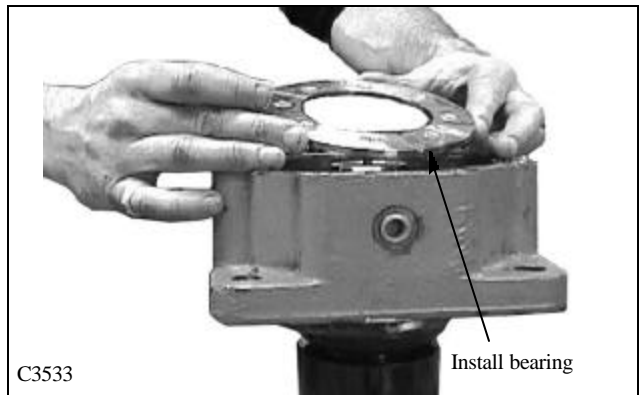

3 Alternate installation of brake disks, first putting in the outer disk (golden color) and then the inner disk (silver color). (fig. 3534)



4 Install the piston after all of the disks have been inserted. There will be air trapped, but this will escape when the spring and cover are installed. (fig. C3535)



DRIVE MOTOR 2.11

5 Install spring plate (fig. C3536)



6 Install brake cover and cross tighten all screws to final torque specification of 65ft/lbs. (fig. C3537)

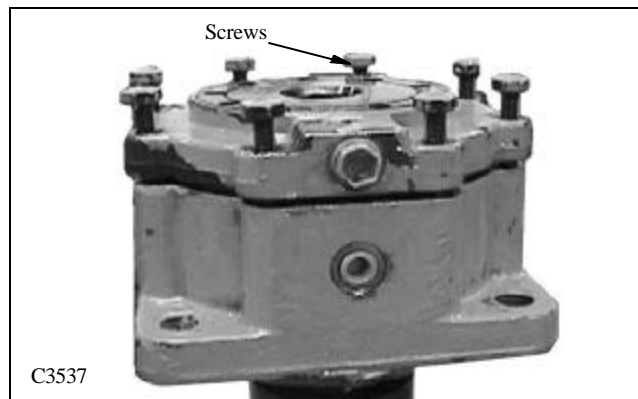

7 Install Cardon shaft and gearwheel. (fig. C3538)

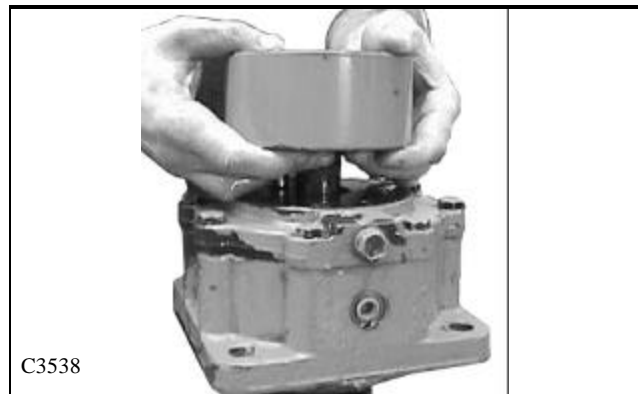

8 With the gearwheel mounted and the cardon shaft in place, place the drive gear valley to valley with the gear-wheel. Mount the channel plate (ensuring the drain holes are aligned) and then valve drive it 15° counter clockwise (one tooth). Then mount the valve housing and re-install the bolts. (fig. C3539).

Incorrect timing will result in the motor operating in reverse.

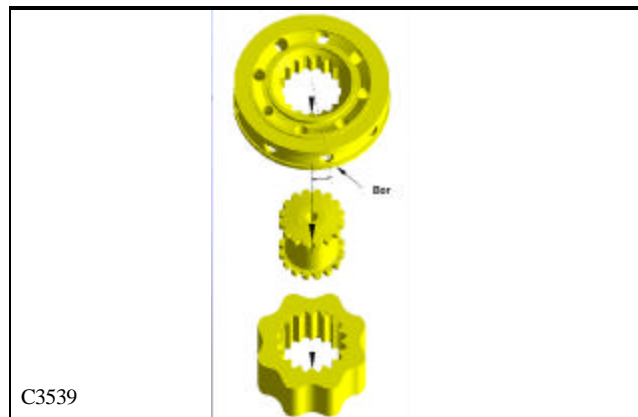

2

DRIVE MOTOR 2.11

Assembly

2

9 Gear-roller stage of motor.
Timing is important to ensure oil pressure/flow enters the correct chamber for proper drive/rotation. (fig. C3540)

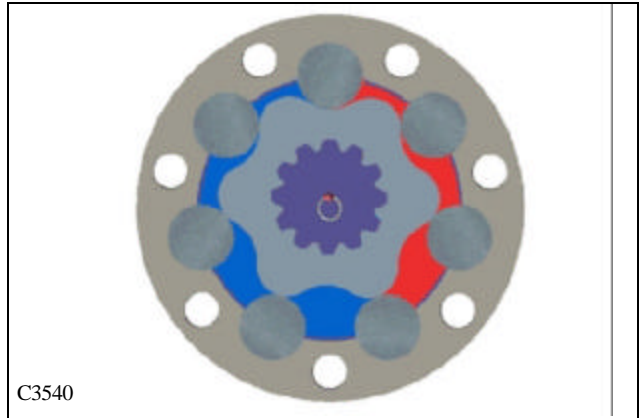

10 When preparing for timing, marker valley to valley in any location on shaft as shown (fig. C3541).



11 Install guide pins on gearwheel (3) and fix channel plate onto gearwheel (fig. C3542)

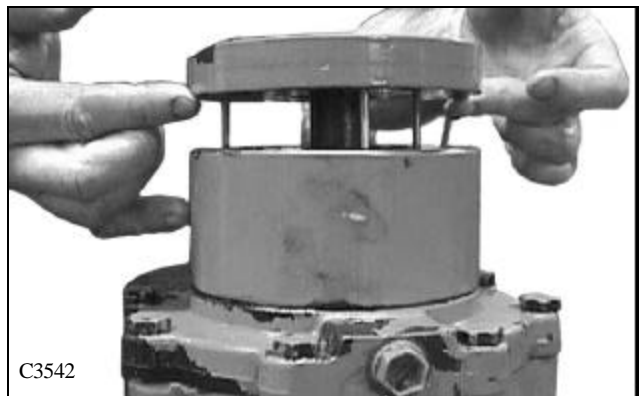

12 Use securing ring and install onto groove on channel plate (fig. C3543).



IMPORTANT

NOTE: The fibre plates are also called outer plates due to the "teeth" outside of the plate.

DRIVE MOTOR 2.11

13 The timing is critical as the gearwheel valley cannot be seen. Use a marker point as a guide to offset 1 tooth counter-clockwise to the disk valve (fig. C3544).

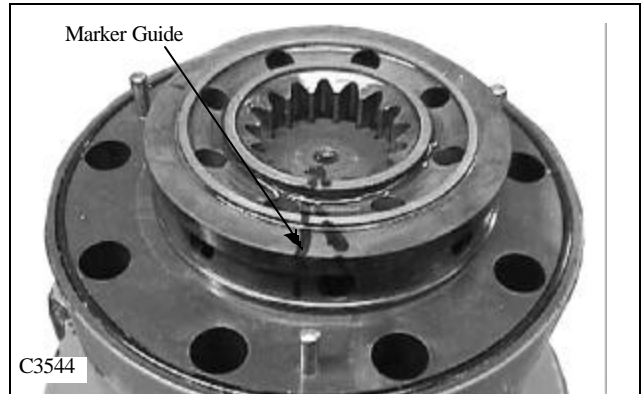

14 In the valve housing, install the 6 springs in the drilled holes (fig. C3545).

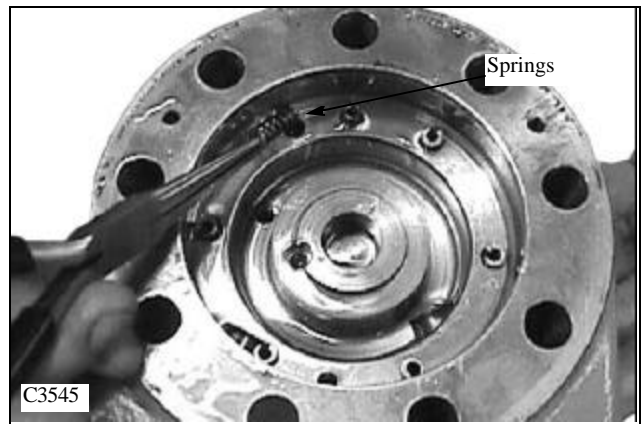

15 Inspect the O-ring seals, and if needed, replace. Install the balance plate and use guide pin for alignment (fig. C3546).

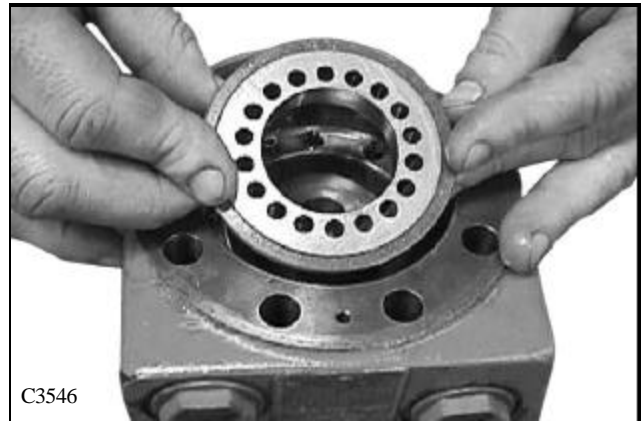

16 Example of an incorrectly installed balance plate. The guide pin becomes damaged and the balance plate is not locked into position. This can cause it to spin and render the motor non-functional (fig. C3547).

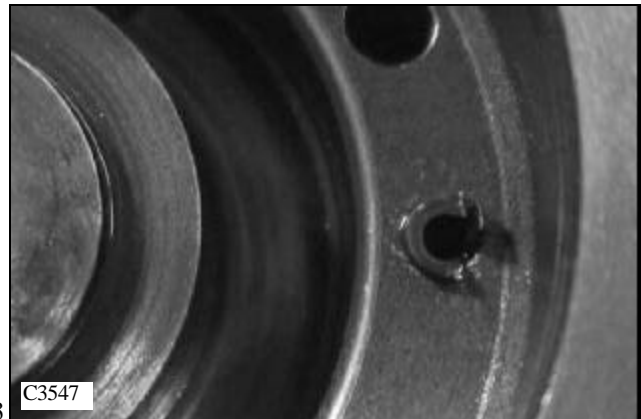

2

DRIVE MOTOR 2.11

17 With a balance plate incorrectly installed other problems such as a break in the valve housing may occur and damage other hydraulic components (fig. C3548).



18 With the balance plate in the proper position and tapped down to seat, apply some vaseline or grease to prevent the spacer from falling out when installed onto the motor (fig. C3549).



19 Since the motor has been disassembled, the guide pins will locate ports in the offset position. To align with the drain and brake ports, turn the section until correct port alignment is made (fig. C3550).

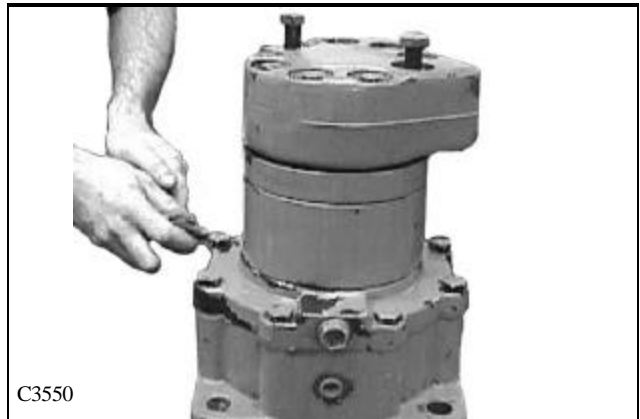

20 With ports all aligned, install balance of screws and tighten in a cross pattern, then final torque all bolts to 81 ft/lbs (fig. C3551).



2

TORQUE CHART 2.12

NOTE: all torque specifications are in ft / lbs. (Multiply by 1.36 = N.m.)

Hydraulic Fittings

HOSE SIZE	37° JIC FITTINGS	HOSE SIZE	ORB FITTINGS
1/4	9 to 10	1/4	14 to 16
5/16	15 to 16	5/16	18 to 20
3/8	20 to 22	3/8	24 to 26
1/2	30 to 33	1/2	50 to 60
5/8	40 to 44	5/8	72 to 80
3/4	70 to 77	3/4	125 to 135
7/8	82 to 90	7/8	160 to 180
1	55 to 60	1	200 to 220
1 1/4	120 to 132	1 1/4	210 to 280
1 1/2	131 to 144	1 1/2	270 to 360
2	300 to 330		

The following torque specifications are for steel ORB fittings into aluminum.

HOSE SIZE	ORB FITTINGS	HOSE SIZE	ORB FITTINGS
1/4	5 to 7	3/4	40 to 45
5/16	8 to 10	7/8	50 to 55
3/8	10 to 12	1	90 to 99
1/2	21 to 24	1 1/4	80to 90
5/8	27 to 30		

Tandem Pump

Description	Qty.	Specification
Front Support	1	50 (+/- 2)
Rear Mounting	2	60 (+/- 2)
Trunion Seal Carrier	4	20 (+/- 2)
Trunion Seal Cover	4	20 (+/- 2)
Relief Valve	4	40 (+/- 10)
Charge Relief Cap	1	40 ~ 100
Tandem Section	4	40 (+/- 5)
Gear Pump	2	25 (+/- 2)

Torque Motor

Description	Qty.	Specification
Valve Housing	8	81 ft/lb
Bearing Housing	8	65 ft/lb
Bearing, Retaining Ring	8 bolts	7 ft/lb
Mounting	4	80ft/lb



CONVERSION CHART 2.13

CONVERSION FACTORS Metric To U.S.

2

	MULTIPLY	BY	TO OBTAIN
Area:	sq. meter	10.763 91	square foot
	hectare	2.471 05	acre
Force:	newton	3.596 942	ounce force
	newton	0.224 809	pound force
Length:	millimeter	0.039 370	inch
	meter	3.280 840	foot
	kilometer	0.621 371	mile
Mass:	kilogram	2.204 622	pound
Mass/Area:	kilogram/hectare	0.000466	ton/acre
Mass/Energy:	gr/kW/hr.	0.001 644	lbs/hp/hr.
Mass/Volume:	kg/cubic meter	1.685 555	lb/cubic yd.
Power:	kilowatt	1.341 02	horsepower
Pressure:	kilopascal	0.145 038	lb/sq.inch
	bar	14.50385	lb/sq.inch
Temperature:	degree C	1.8 x C + 32	degree F
Torque:	newton meter	8.850 748	lb/inch
	newton meter	0.737 562	lb/foot
Velocity:	kilometer/hr.	0.621 371	miles/hr.
Volume:	cubic centimeter	0.061 024	cubic inch
	cubic meter	35.314 66	cubic foot
	cubic meter	1.307 950	cubic yd.
	millimeter	0.033 814	ounce (US fluid)
	litre	1.056 814	quart (US liquid)
	litre	0.879 877	quart (Imperial)
	litre	0.264 172	gallon (US liquid)
	litre	0.219 969	gallon (Imperial)
Volume/Time:	litre/min.	0.264 172	gallon/min. (US liquid)
	litre/min.	0.219 969	gallon/min. (Imperial)

CONVERSION CHART 2.13

CONVERSION FACTORS

U.S. To Metric

	MULTIPLY	BY	TO OBTAIN
Area:	sq. foot	0.092 903	square meter
	acre	0.404 686	hectare
Force:	ounce force	0.278 014	newton
	pound force	4.448 222	newton
Length:	inch	25.4	millimeter
	foot	0.304 8	meter
	mile	1.609 344	kilometer
Mass:	pound	0.453 592	kilogram
	ounce	28.35	gram
Mass/Area:	ton/acre	2241 702	kilogram/hectare
Mass/Energy:	lb/hp/hr	608.277 4	gr/kW/hr
Mass/Volume:	lb/cubic yd.	0.5930276	kg/cubic meter
Power:	horsepower	0.745 700	kilowatt
Pressure:	lbs/sq.in.	6.894 757	kilopascal
	lbs/sq.in.	0.069	bar
	lbs/sq.in.	0.070 303	kg/sq.cm
Temperature:	degree F	1.8 F - 32	degree C
Torque:	pound/inch	0.112 985	newton meter
	pound/foot	1.355 818	newton meter
Velocity:	miles/hr.	1.609 344	kilometer/hr.
Volume:	cubic inch	16.387 06	cubic centimeter
	cubic foot	0.028 317	cubic meter
	cubic yard	0.764 555	cubic meter
	ounce (U.S. fluid)	29.573 53	milliliter
	quart (U.S. liquid)	0.946 353	litre
	quart (Imperial)	1.136 523	litre
	gallon (U.S.)	3.785 412	litre
	gallons (Imperial)	4.546 092	litre
Volume/Time:	gallon/min.	3.785 412	litre/min.

