

# SECTION 5 ELECTRICAL

Specifications	5.1
General Information.....	pg. 5-2
Wiring Schematic	5.2
ROPS Harness .....	pg. 5-3, 5-5
Engine Harness.....	pg. 5-6, 5-8
Instrumentation	5.3
Left Hand Dash Panel.....	pg. 5-9
Switch and Bulb Replacement.....	pg. 5-9
Right Hand Dash Panel .....	pg. 5-10
Fuel Gauge.....	pg. 5-10
Fuel Sender .....	pg. 5-11
Hour Meter.....	pg. 5-11
Ignition Switch	5.4
Ignition Switch Test .....	pg. 5-12
Engine Glow Plugs	5.5
Glow Plug Test.....	pg. 5-13
Indicator Test .....	pg. 5-13
Ignition Switch Test .....	pg. 5-13
Battery (dual optional)	5.6
Removal & Inspection .....	pg. 5-14
Boosting .....	pg. 5-15
Circuit Breaker.....	pg. 5-15
Electrical Panel	5.7
Fuse & Relay Replacement .....	pg. 5-16
Starter Circuit	5.8
Schematic .....	pg. 5-17
Charging Circuit	5.9
Schematic .....	pg. 5-18
Safety Circuit	5.10
Schematic .....	pg. 5-19
General Information.....	pg. 5-20
Auxiliary Circuit	5.11
Schematic .....	pg. 5-21
Auxiliary Control Handle .....	pg. 5-22
Accessory Circuit	5.12
Schematic .....	pg. 5-23
Trouble Shooting	5.13
Guide .....	pg. 5-24, 5-25



---

## SPECIFICATIONS 5.1

---

Ignition .....	12 Volts
Grounding .....	Negative
Alternator Brand .....	Nippondenso
Alternator Rating .....	40 Amp
Alternator Type .....	Internal Regulator
Battery (std) .....	One (1)
Battery Rating .....	730 CCA, ..... 125 Reserve Minutes (each)
Battery Type .....	SERV 3478
Starter Brand .....	Nippondenso
Pre - Heater .....	Four (4) Glow plugs
Glow Plug Location .....	Cylinder Head ..... (Pre - combustion chamber)
Circuit Breaker .....	40 Amp
Fuse Rating:	
Engine Shut Off Solenoid .....	15 Amp
Alternator .....	10 Amp
Safety Circuit .....	10 Amp
Horn .....	10 Amp
Aux. Hydraulics .....	10 Amp
Cab Heater .....	10 Amp
Back up Alarm .....	10 Amp
Dome Light .....	10 Amp
Starter .....	40 Amp Relay
Glow Plugs .....	40 Amp Relay



# WIRING SCHEMATIC 5.2

## ROPS Harness Connector

Diagram C1741 Legend. Shown is the wire color and function of each pin terminal in the connector plug.

PIN	WIRE COLOR	FUNCTION
1	Purple	Eng. oil press. indicator
2	White	Ignition (30)
3	Red / Wht	Ignition (19)
4	Blk / Wht	Ignition (acc)
5	Tan	Ignition (50)
6	Grey	Seat belt indicator
7	Grey / Wht	Charge (L) indicator
8	Blue / Wht	Hyd. temp. indicator
9	Org / Blue	Fuel level (+) gauge
10	Red / Org	Headlight
11	Brn / Wht	Brake light
12	Wht / Brn	Horn
13	Pple / Wht	Coolant temp. indicator
14	Pink	Air filter indicator

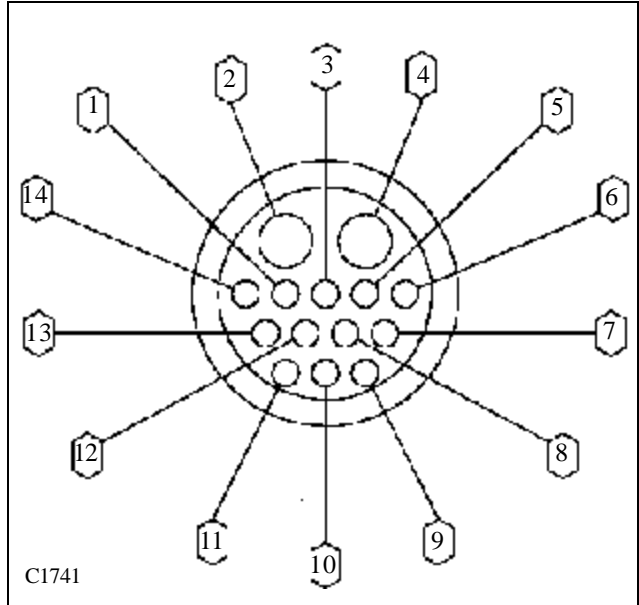

The photographs below and at right show the actual ROPS harness plug connection.

To separate the main electrical harness connection, push the locking tab in the direction of the arrow (fig. C2066) and twist the collar clockwise to release.

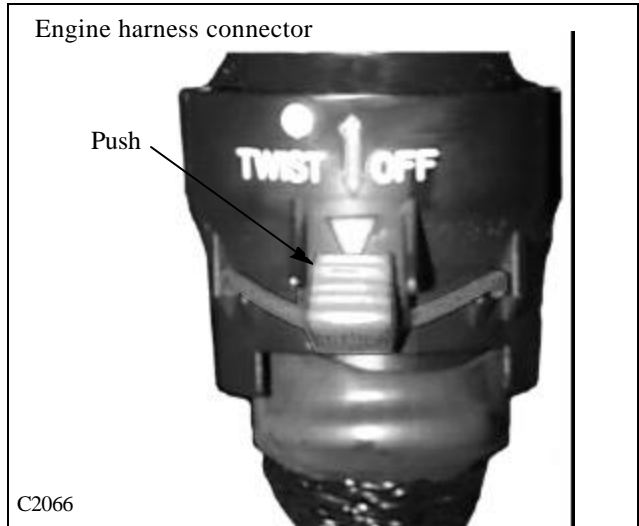
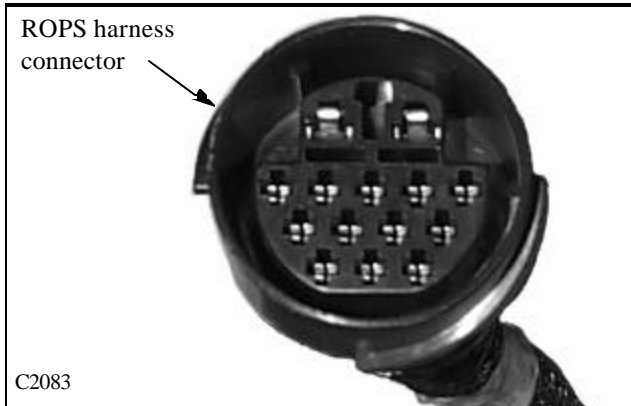
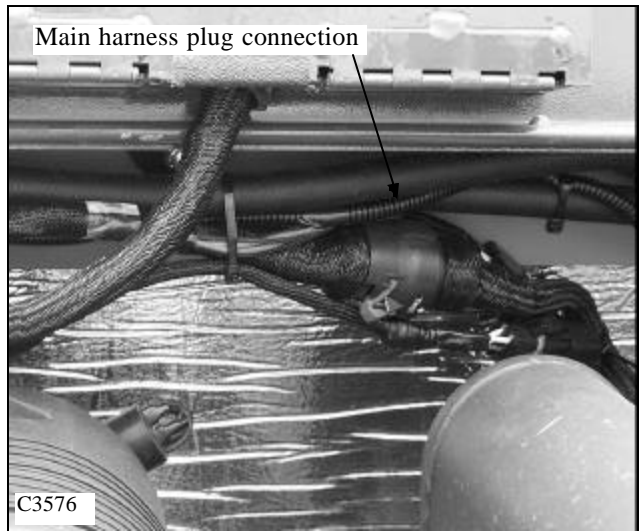

5

# WIRING SCHEMATIC 5.2

ROPS Electrical Wiring 175

C4187

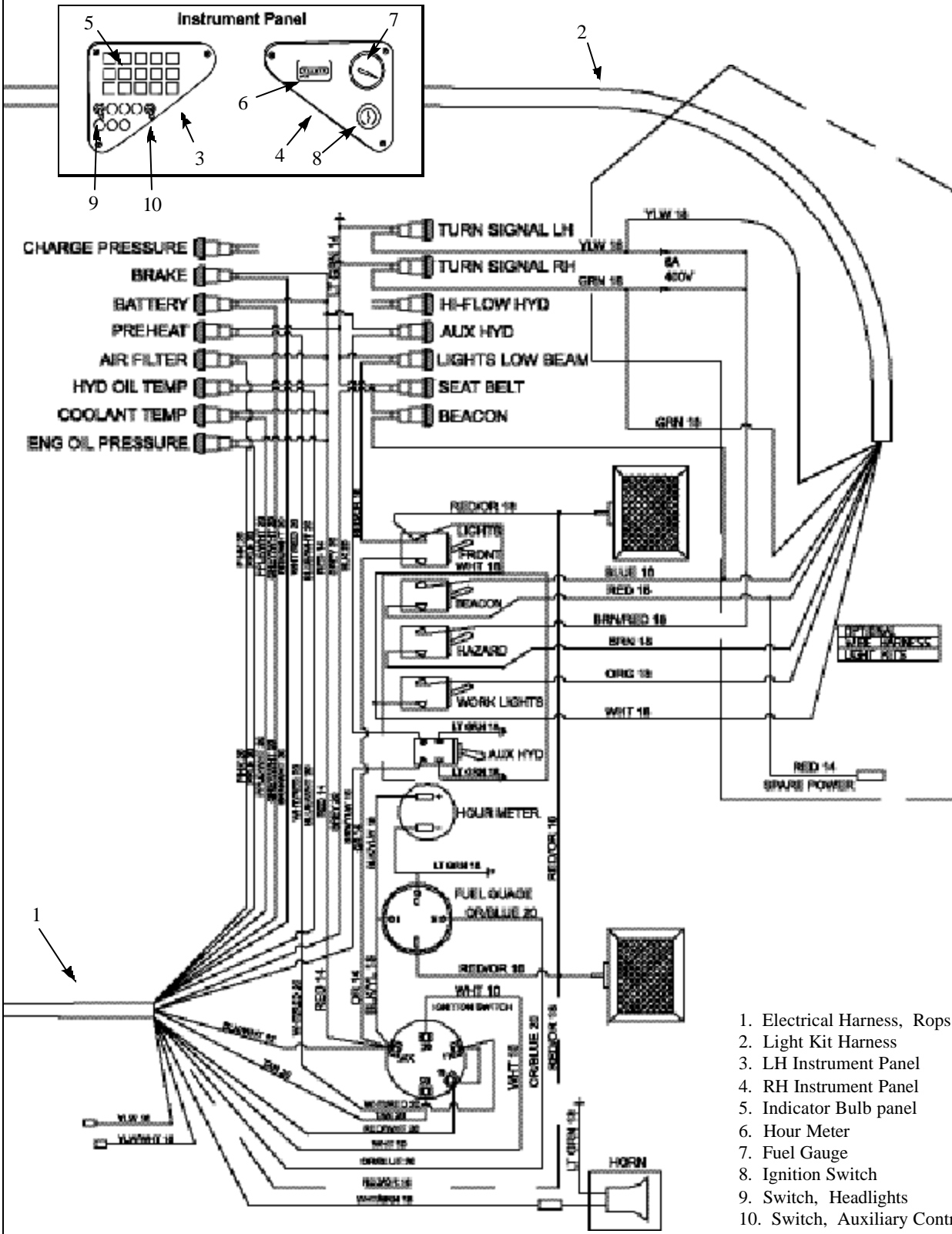

5

# WIRING SCHEMATIC 5.2

ROPS Electrical Wiring 1700

C3688

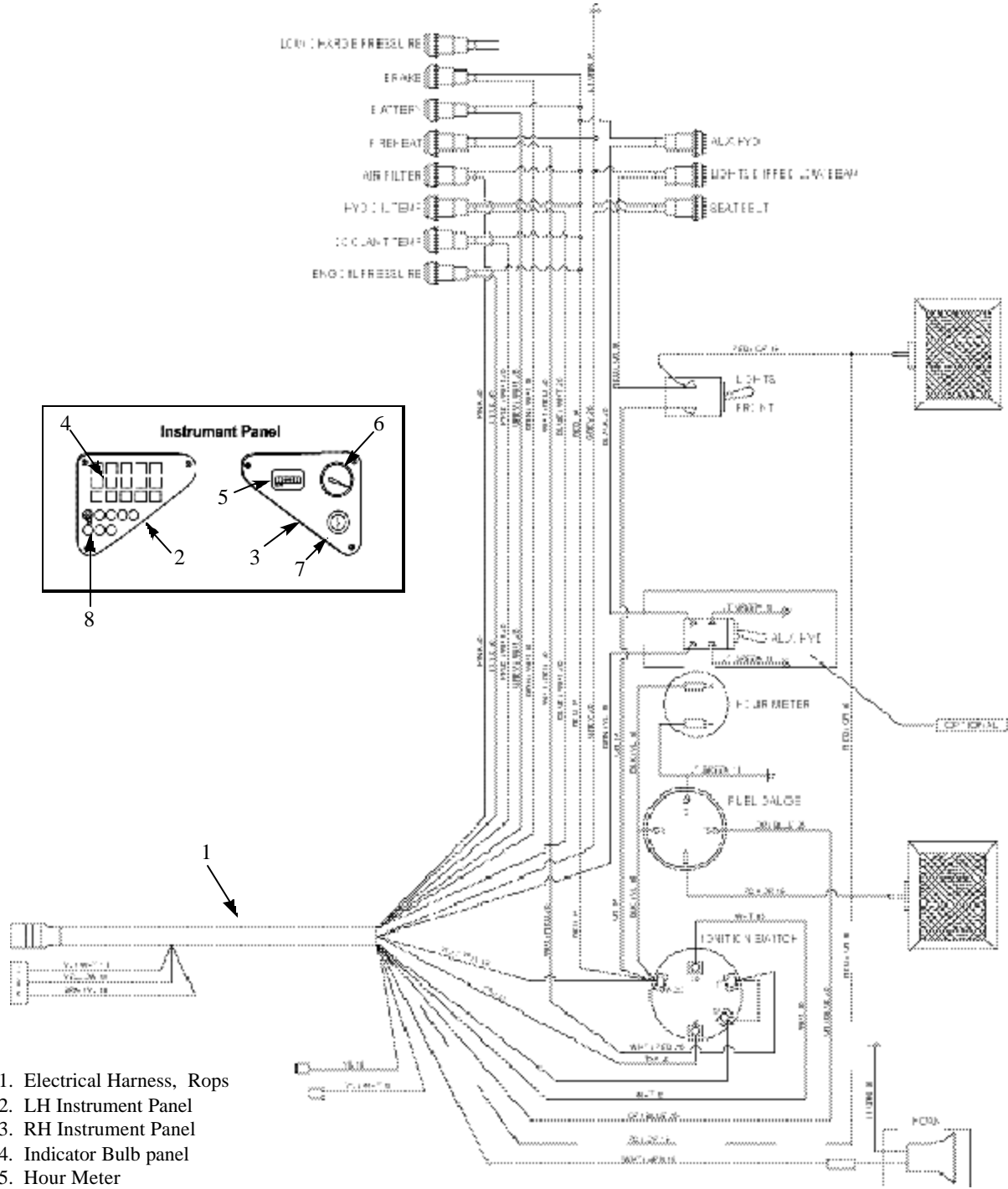

1. Electrical Harness, Rops
2. LH Instrument Panel
3. RH Instrument Panel
4. Indicator Bulb panel
5. Hour Meter
6. Fuel Gauge
7. Ignition Switch
8. Switch, Headlights



# WIRING SCHEMATIC 5.2

## Engine Harness Connector

Diagram C1741a Legend. Shown is the wire color and function of each pin terminal in the connector plug.

PIN	WIRE COLOR	FUNCTION
1	Tan	Starter relay
2	Blk / Wht	Fuse block
3	Red / Wht	Glow plug relay
4	White	Circuit breaker
5	Purple	Engine oil pressure
6	Pink	Air filter
7	Pple / Wht	Coolant temperature
8	Wht / Brn	Horn button
9	Brn / Wht	Brake light switch
10	Red / Org	Rear light
11	Org / Blue	Fuel level (+)
12	Blue / Wht	Hydraulic temperature
13	Grey / Wht	Alternator (L)
14	Grey	Seat Belt

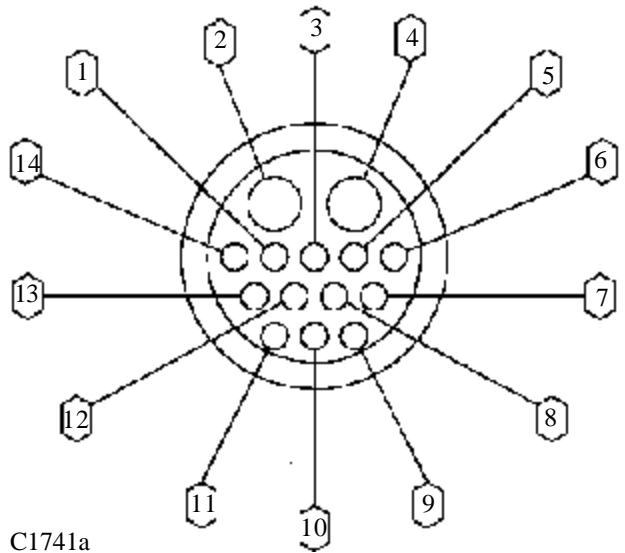

5

The photographs below and at right show the actual Engine harness plug connection. To separate the main electrical harness connection, push the locking tab in the direction of the arrow (fig. C2066) and twist the collar clockwise to release.

Engine plug



Main harness plug connection

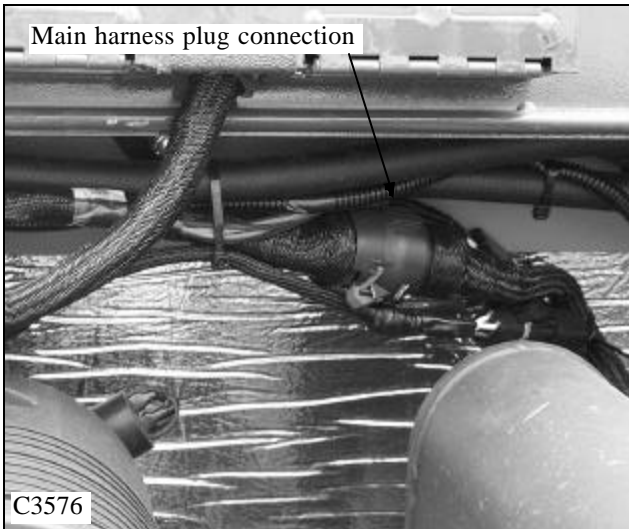

Engine plug

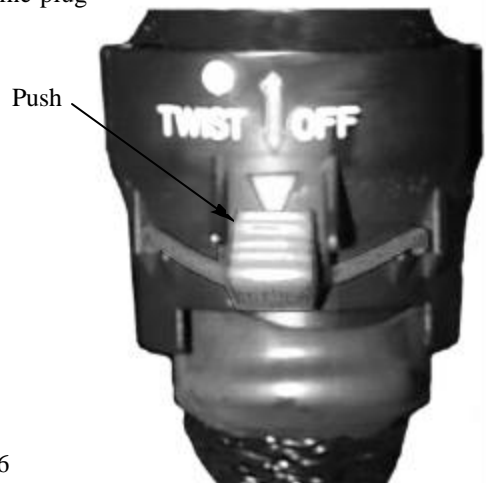

# WIRING SCHEMATIC 5.2

Engine Electrical Wiring 175

C4188

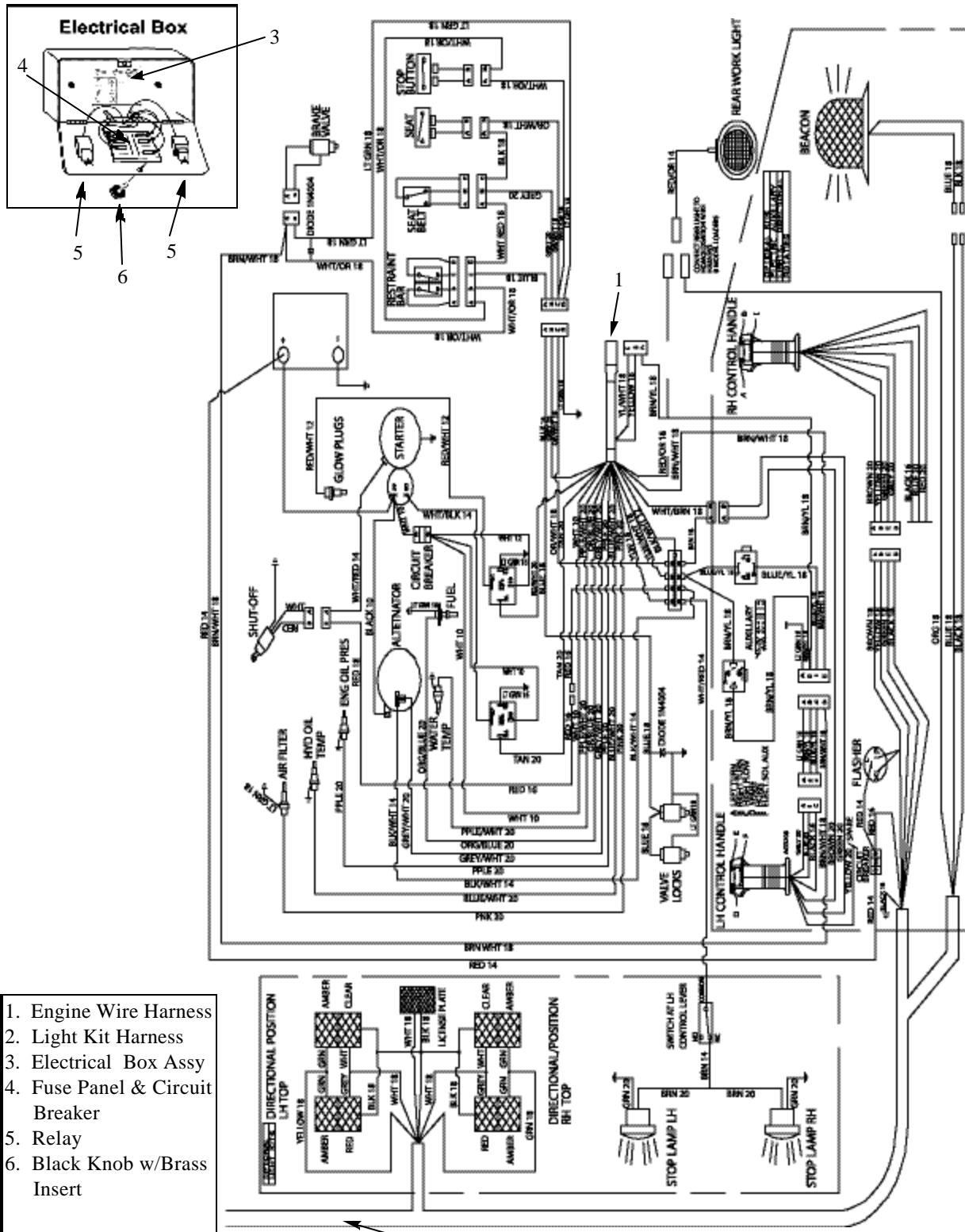

1. Engine Wire Harness
2. Light Kit Harness
3. Electrical Box Assy
4. Fuse Panel & Circuit Breaker
5. Relay
6. Black Knob w/Brass Insert



# WIRING SCHEMATIC 5.2

Engine Electrical Wiring 175

C3690

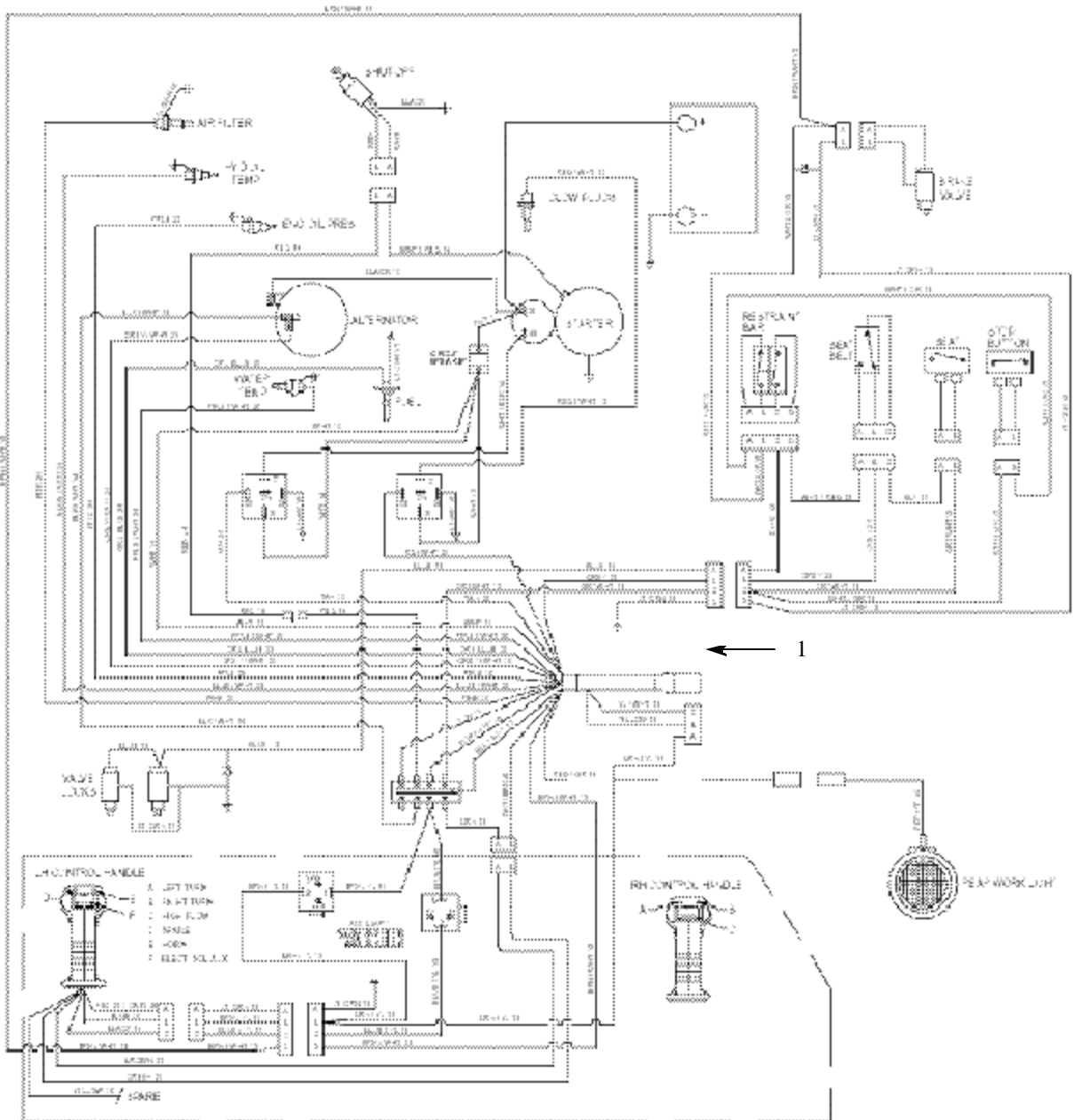

1. Engine Wire Harness
2. Electrical Box Assy & Circuit Breaker
3. Fuse Panel
4. Relay
5. Black Knob w/Brass Insert

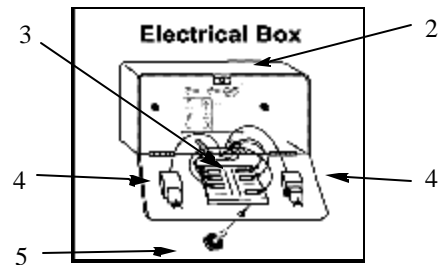



# INSTRUMENTATION 5.3

## Legend for fig. C3577

- 1 LH Turn Signal
- 2 Aux. Hydraulic Indicator
- 3 Hi-Flow Hydraulic Indicator
- 4 Headlight Indicator
- 5 RH Turn Signal
- 6 Hyd. Oil Temperature Indicator
- 7 Parking Brake Indicator
- 8 Seat Belt Indicator
- 9 Hyd. Charge Pressure Indicator
- 10 Strobe Light Indicator
- 11 Engine Oil Pressure
- 12 Engine Coolant Temperature
- 13 Alternator Indicator
- 14 Air Filter Restriction Indicator
- 15 Engine Preheat Indicator
- 16 Headlight Switch
- 17 Strobe Light Switch
- 18 Four Way Flasher Switch
- 19 Work light Switch
- 20 Aux. Hydraulics Switch
- 21 Hi-Flow Hydraulic Switch
- 22 Spare Switch Hole
- 23 Spare Switch Hole

## Switch & Bulb Replacement

To replace a malfunctioning switch or indicator light:

- 1 Remove the 3 screws retaining the electrical panel to the dash pod. (fig. C3577, C3578)
- 2 Disconnect the spade terminals on the rear of the switch. (fig. C3578)
- 3 Remove the switch by loosening the hex nut on the back, then unscrewing the knurled nut on the front of the electrical panel.
- 4 Replace an indicator bulb by turning out the socket and pull bulb out.
- 5 Replace the switch, indicator light and panel in the reverse order.

If the dash pod is damaged, remove the 2 mounting bolts and slip over the dash panel. (fig. C3579)

Disconnect all panel wiring if replacing the complete unit. Replace the parts in reverse order. Follow the wiring schematic to properly locate the switches and wiring in position.

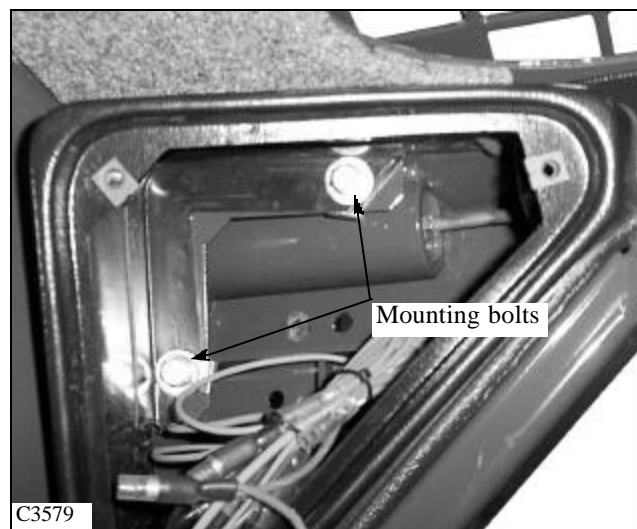
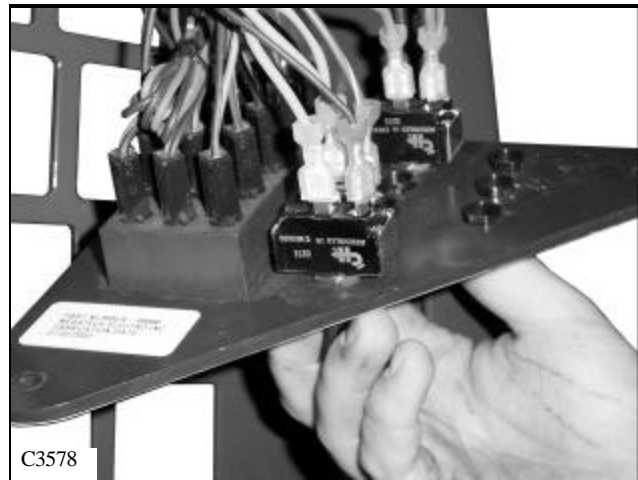
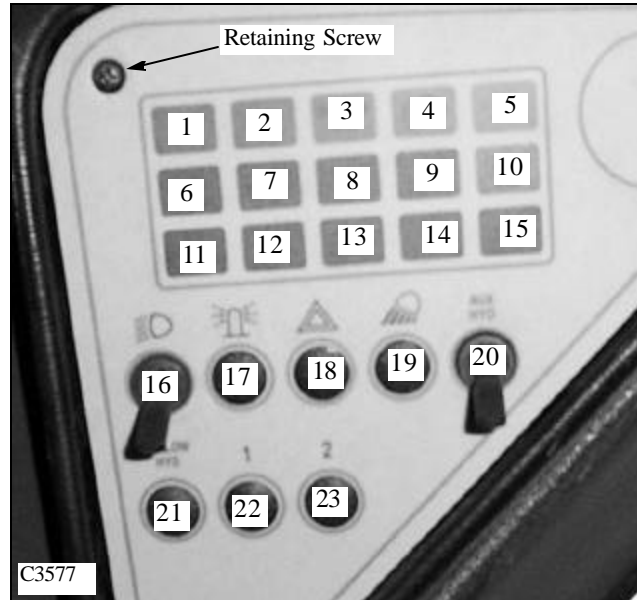

# INSTRUMENTATION 5.3

## Replacement

To replace a faulty gauge, meter or switch in the right hand dash panel:

- 1 Disconnect the battery cable connection.
- 2 Remove the 3 screws retaining the dash panel to the dash pod. (fig. C3580)
- 3 Access the rear of the dash panel.
- 4 Remove the wiring from the effected part.
- 5 The fuel gauge is retained by a bracket and 2 mounting nuts. Remove the nuts and the gauge can be replaced.
- 6 The ignition switch is retained by the knurled nut on the outside of the dash panel. Remove the nut and the switch can be replaced.
- 7 The hour meter is retained in the dash panel with molded in tabs. Pull the tabs outward and the hour meter can be replaced.

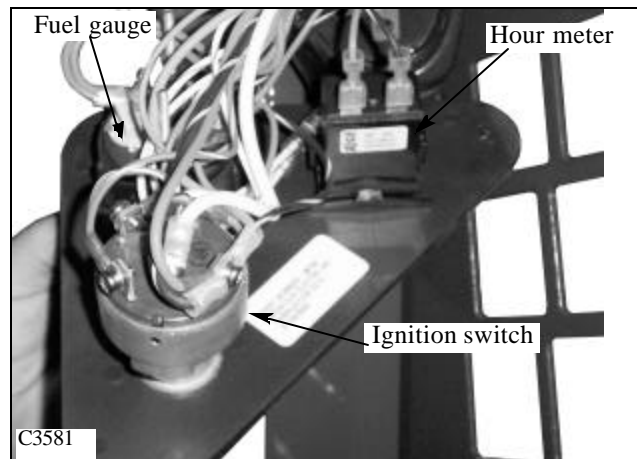
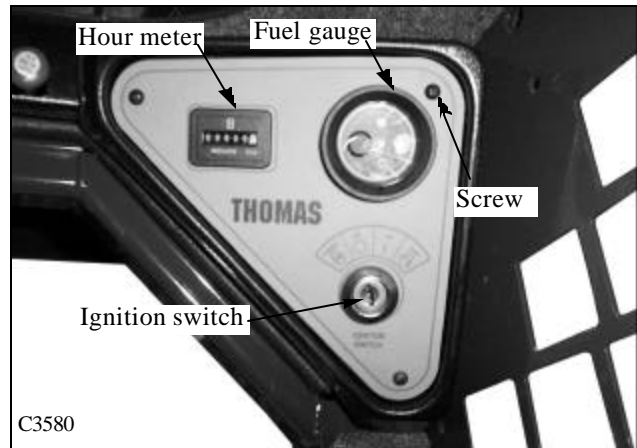

## Testing the Fuel Gauge

- 1 Remove the right hand dash panel to access the gauge. (fig. C3581)

- 2 With the ignition switch off, connect an ohmmeter between the “S” terminal and the “I” terminal. (fig. C307)
  - 3 An ohmmeter reading of 150 to 250 ohms is normal. A higher or lower reading means the gauge is faulty and needs to be replaced.
- NOTE: If the fuel gauge test results were good and the gauge still fails to function do the following test.

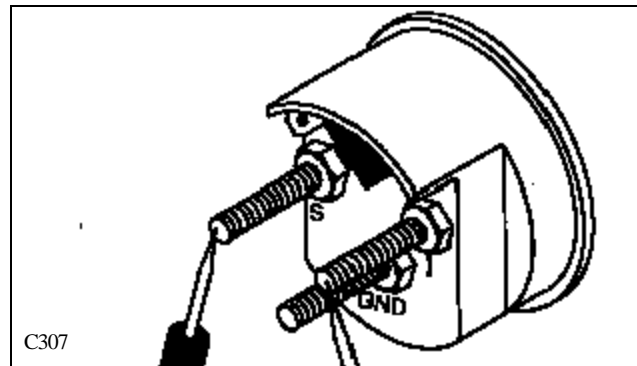

- 1 With the ignition switch off, connect an ohmmeter between the “S” terminal and the other end to ground.
  - 2 An ohmmeter reading of 50 to 500 ohms is normal. A higher or lower reading means the wire going to the “S” terminal is faulty.
- NOTE: If the test is good, check the fuel sending unit in the fuel tank for failure.

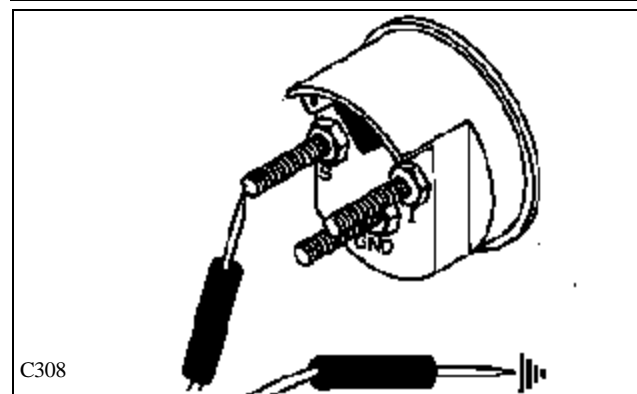

# INSTRUMENTATION 5.3

## Testing the Fuel Sender

- 1 With the ignition switch off, connect an ohmmeter between the positive and negative terminals of the fuel sending unit. (fig. C306)
- 2 An ohmmeter reading of 50 to 500 is normal. A reading higher or lower means a faulty sender and will need replaced.

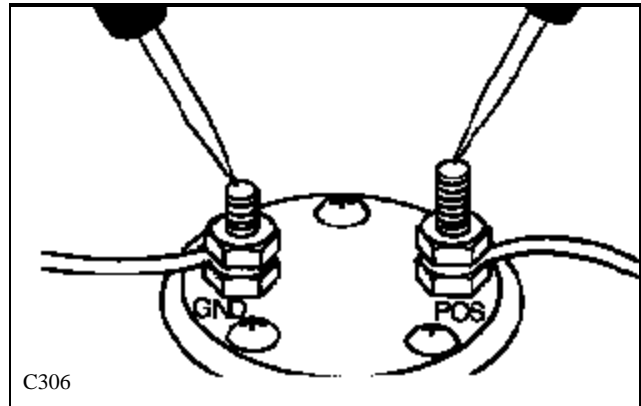

## Replacement

- 1 Remove any attachment, raise the boom arms and engage the boom support pins. Shut off the engine and engage the parking brake.
- 2 Remove the 2 wires connected to the fuel sending unit. The fuel sender is located just below the lift cylinder, right hand side, on the fuel tank.
- 3 Remove the 5 screws retaining the sender to the fuel tank.
- 4 Remove the sending unit and discard the gasket.
- 5 Install a new sending unit and gasket. Use gasket sealant on both sides of the gasket.
- 6 Use thread sealant on the screws and torque the screws to 20 inch / lbs. (fig. C3582)
- 7 Connect the sender wires taking care not to over tighten the nuts and stripping the studs. Green wire is ground.

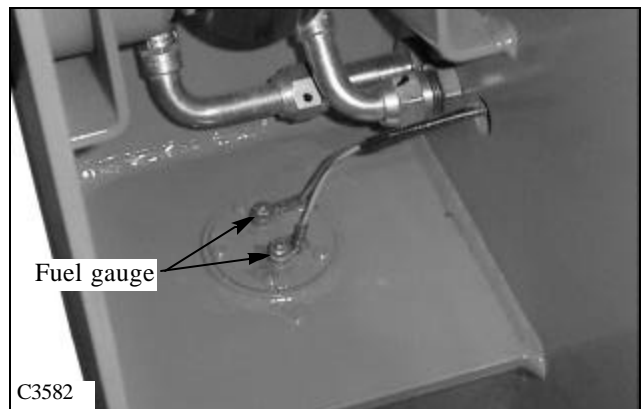

## Testing the Hour Meter

The hour meter records the number of engine operating hours.

To check the hour meter, remove the 3 screws retaining the right hand dash panel to the dash pod. (fig. C3580, C3581)

Using a 12 volt test meter, connect the positive lead to the positive terminal of the hour meter and the ground lead of the tester to a good ground. Turn the ignition switch to the "RUN" position.

A reading of 12 volts means the hour meter is operating properly.

No voltage reading means there could be a problem in the wire running from the "ACC" terminal on the ignition switch to the positive side of the hour meter or a defective ignition switch.

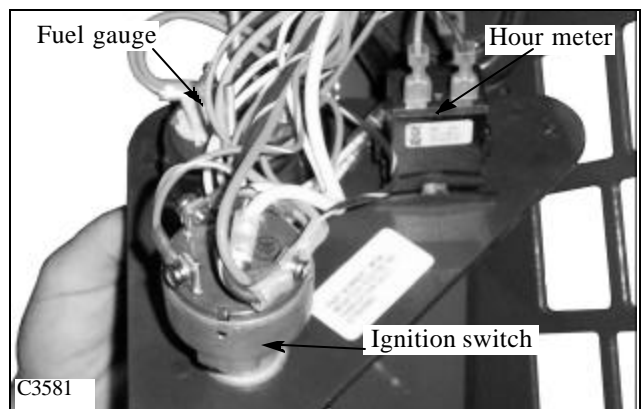
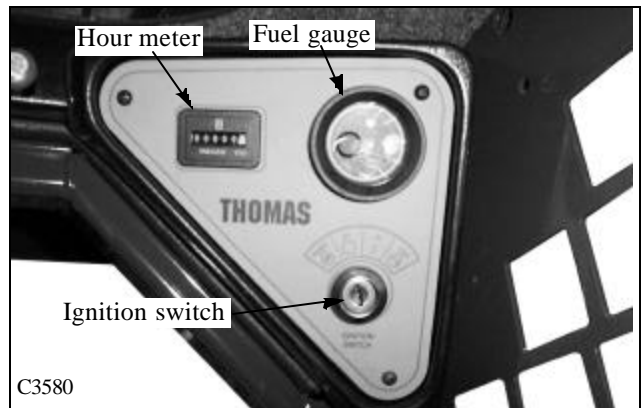

5

# IGNITION SWITCH 5.4

## Ignition Switch Testing

The ignition switch is a 4 position switch. OFF, PRE-HEAT, RUN and START. Turning the key counterclockwise will engage the PREHEAT. To activate the starter, turn the key clockwise. When the key is released it will return to the RUN position.

Before performing any test to the ignition switch, disconnect the negative or ground wire from the battery terminal. Remove the 3 screws retaining the right hand dash panel to the dash pod to access the ignition switch.

### TEST 1: "RUN" POSITION.

Connect an ohmmeter across the terminals marked 30 and ACC. (fig. C297) Turn the ignition switch to the run position.

A low resistance reading is normal. High resistance reading means you will have to replace the ignition switch.

### TEST 2: "START" POSITION.

(a) Connect an ohmmeter between the terminals marked 30 and 50 on the ignition switch. (fig. C298) Turn the ignition switch to the "START" position and observe the ohm readings.

(b) Connect the ohmmeter leads across terminals marked 30 and 17 on the ignition switch. (fig. C299) Turn the ignition switch to the "START" position and observe the ohmmeter reading.

Low resistance reading is normal.

High resistance reading means the ignition switch needs replacement.

### TEST 3: "HEAT" POSITION.

Connect the ohmmeter leads between the terminals marked 30 and 19 on the ignition switch. (fig. C300) Turn the ignition switch to the "HEAT" position and observe the ohmmeter readings.

Low resistance reading normal.

High resistance reading, replace the ignition switch.

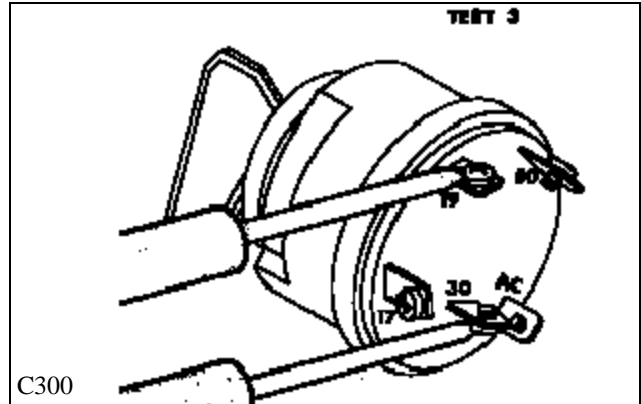
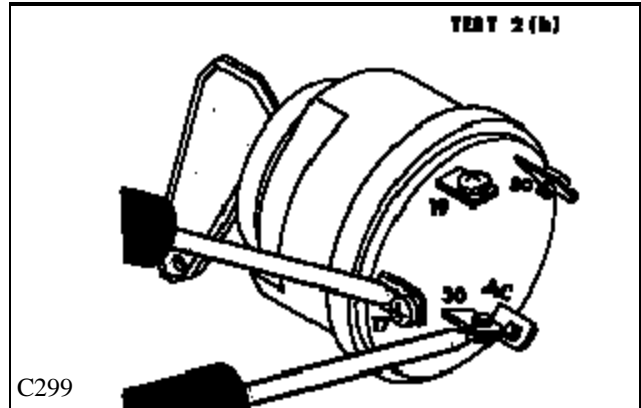
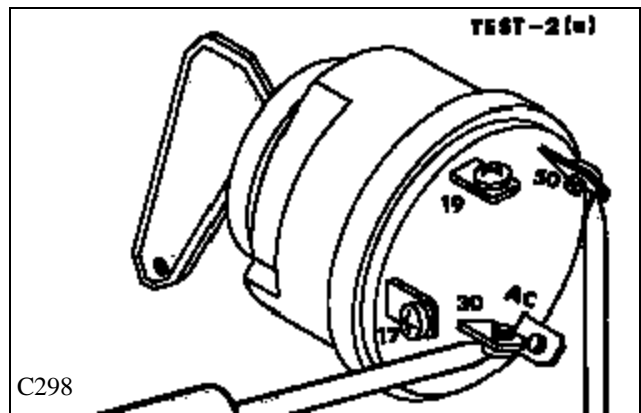
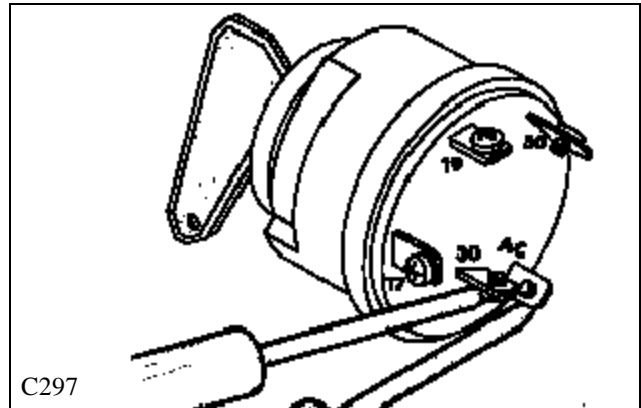

# ENGINE GLOW PLUGS 5.5

## Testing the Glow Plugs

Before performing any test on the glow plugs, disconnect the ground wire from the battery.

### TEST 1: GLOW PLUGS.

With the ignition switch off, connect one end of the ohmmeter lead to the manifold heater terminal and the other lead end to a clean ground.

A reading of 1.5 ohms is normal.

An infinite or 0 reading means the heater is defective.

### TEST 2: IGNITION SWITCH to GLOW PLUGS.

Remove the 3 screws retaining the right hand dash panel to the dash pod. (fig. C3580, C3581) With the ignition switch off, disconnect the red / white wire from ignition terminal 19. Connect one ohmmeter lead to the terminal marked 19 on the ignition switch and the other lead to the red / white wire.

Low to 0 reading means good continuity.

High reading means the red / white wire from the ignition switch to the manifold heater is defective.

### TEST 3 IGNITION SWITCH "HEAT" POSITION.

Connect the ohmmeter leads between the terminals marked 30 and 19 on the ignition switch. (fig. C300) Turn the ignition switch to the "HEAT" position and observe the ohmmeter readings.

Low resistance reading normal.

High resistance reading, replace the ignition switch.

## Pre-Heat Indicator

Check the ignition switch terminals 17 and 19 with an ohmmeter. If there is good continuity between the two terminals the bulb or wiring is bad on the pre-heat indicator light.

To change the indicator bulb, remove the 3 screws retaining the left hand dash panel to the dash pod. Select the proper bulb, twist and pull the bulb from the dash panel. Disconnect the wires and replace the bulb in reverse order.

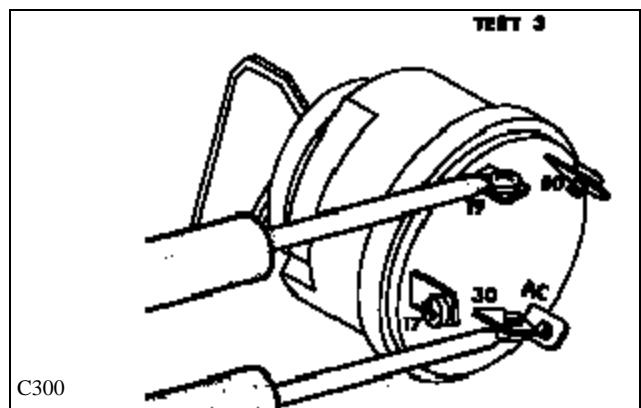
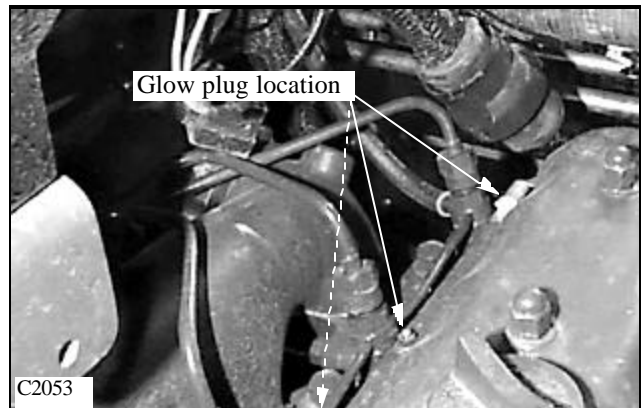

# BATTERY 5.6

## Removal and Inspection

The batteries are located in the ROPS behind the operators seat. To remove the battery:

- 1 Remove the seat mount retaining bolts and disconnect the seat switch wiring harness. (fig. C3557)
- 2 Pull up and toward the front of the loader and remove the seat. Be careful to not catch any electrical wiring while removing.

- 3 Remove the access bolt from the battery compartment cover. (fig. C3583)

**5**

**WARNING**

**Batteries contain sulfuric acid which can harm the eyes and skin on contact. Always wear goggles and protective clothing while servicing the battery. Flush skin or eyes with water upon contact. Consult a physician.**

- 4 Raise the battery compartment cover and latch the prop bar in place. (fig. C3584)
- 5 Disconnect both battery ground terminals first. Then disconnect the positive cables from the battery. (fig. C3585)

- 6 Remove the bolt securing the battery hold down bracket. (fig. C3585)
- 7 Carefully remove the battery from the compartment.
- 8 Inspect the battery cables for corrosion and damage. Remove any corrosion using a wire brush and a soda solution. Replace the cables having damaged or deformed ends.
- 9 Clean the outside of the battery case if the battery is to be reused. Flush the terminal areas with a soda solution taking care not to allow the solution into the battery cells. Remove corrosion from the battery terminals with a wire brush..

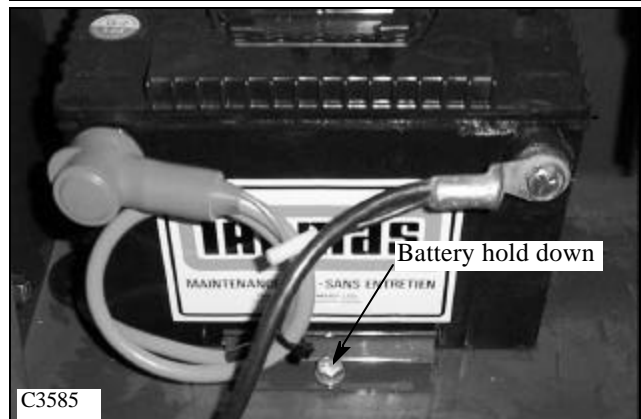
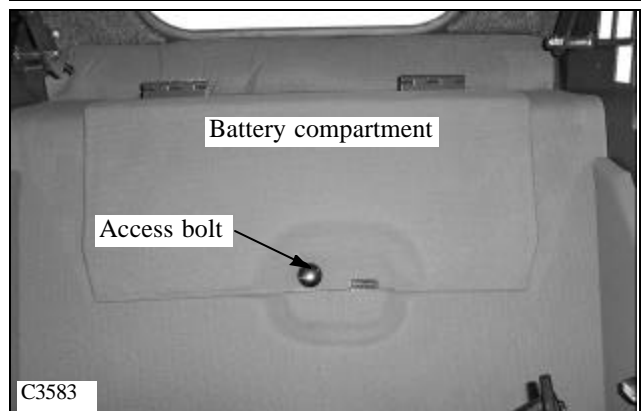

# BATTERY 5.6

## Removal and Inspection

10 Inspect the battery case for cracks that may allow electrolyte to leak into the environment. Inspect the batteries on a regular basis for damage such as cracks or a broken case. Inspect the battery cables for tightness and corrosion. Remove any corrosion and coat the terminals with a dielectric grease. Check the battery hold downs to be sure they are properly retaining the battery in the compartment. (fig. C3585)

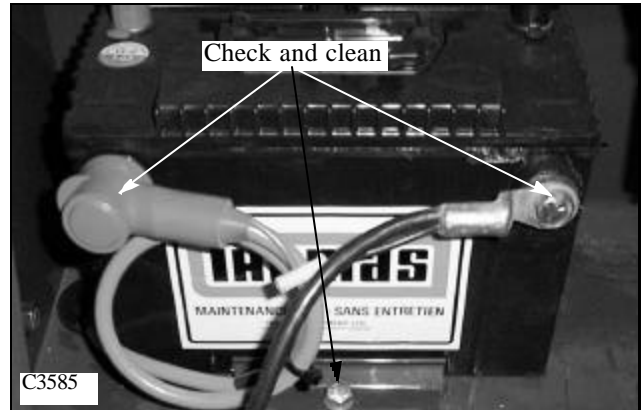

## Boosting

In the event the loader has failed to start and requires boosting, a boosting lug or post is located in the engine compartment. (fig. C3586)

- 1 Open the rear door and raise the engine compartment cover.
- 2 Remove the red rubber protective cover from the boosting lug. (fig. C1029)
- 3 The ignition must be in the off position.
- 4 Connect the positive cable from the 12 volt boosting supply to the boosting lug on the loader.
- 5 Connect the negative ground cable to the boosting supply first, and then to a clean ground on the loader engine. Keep the cables away from any moving parts.
- 6 Start the engine.
- 7 Remove the negative ground cable from the engine first and then the boosting supply. Remove the positive cable from the boosting lug.

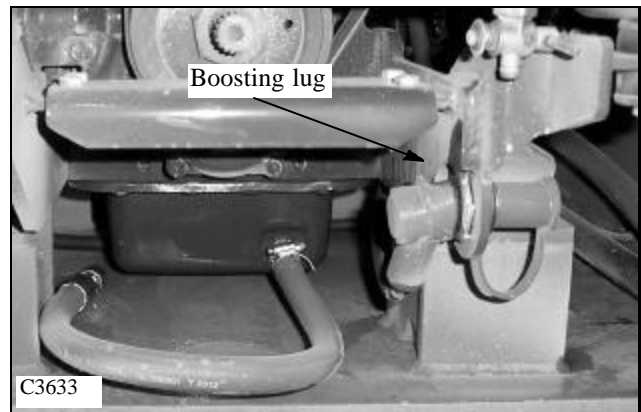
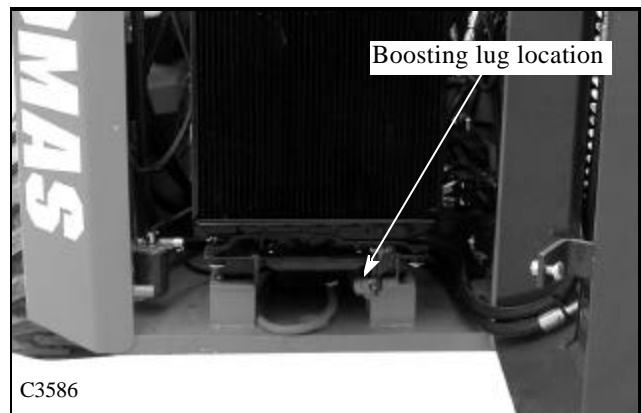

## Circuit Breaker

The circuit breaker is located in the engine harness, right hand side of engine. (fig. C3587) The circuit breaker is covered by loom and is not immediately visible to the eye.

- 1 Disconnect the battery grounds before testing or replacing the circuit breaker.
- 2 Strip the loom covering back to access the circuit breaker.
- 3 Remove the 2 nuts retaining the wires to the circuit breaker.
- 4 Using an ohmmeter, connect a lead to each of the stud terminals and take a reading. Low resistance is normal. High resistance means the circuit breaker is defective and must be replaced.

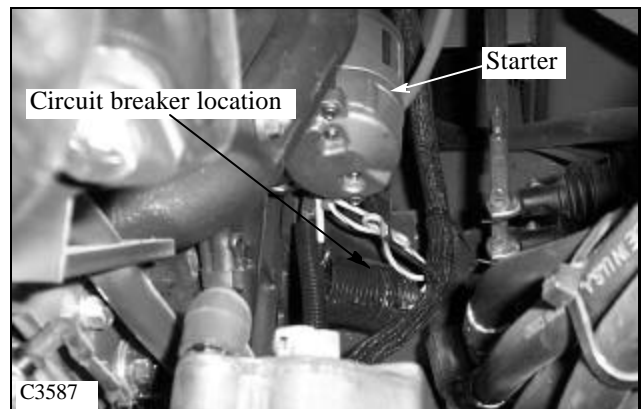

# ELECTRICAL PANEL 5.7

The loader is equipped with a 12 volt, negative ground electrical system. The fuse and relay panels are located in the engine compartment, attached to the underneath of the engine cover. (fig. C3588)

To access the electrical panel:

- 1 Open the rear door and raise the engine cover.
- 2 Remove the bolt holding the electrical panel cover closed. (fig. C3588)
- 3 Open the cover and all fuses and relays will be exposed. (fig. C3589)

Visually check the fuses for burnt contacts.

The relays are identical and may be checked by swapping one for the other to trace a malfunction. If changing the relays around does not repair the problem, the problem is somewhere else.

The ground bolt should be checked occasionally for corrosion and cleaned if necessary. Use a dielectric grease to protect the ground point from the elements.

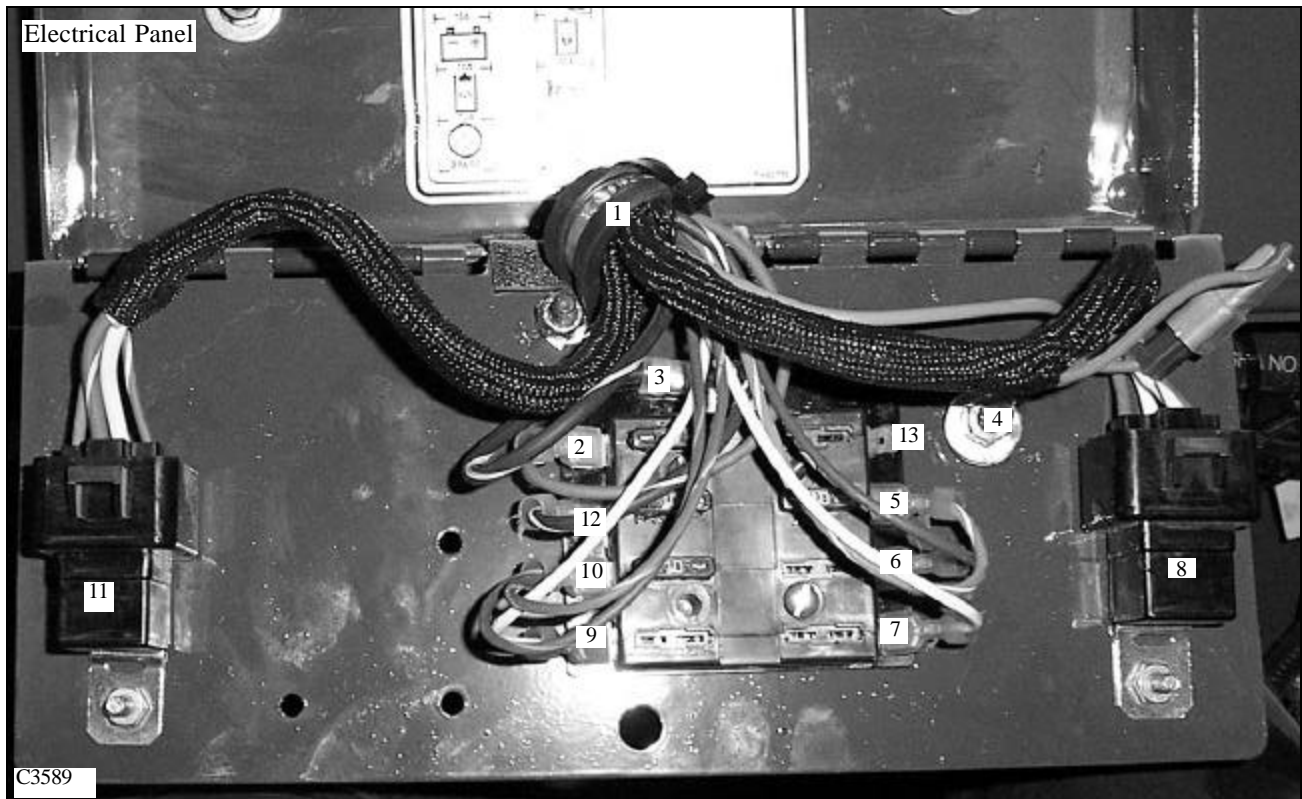
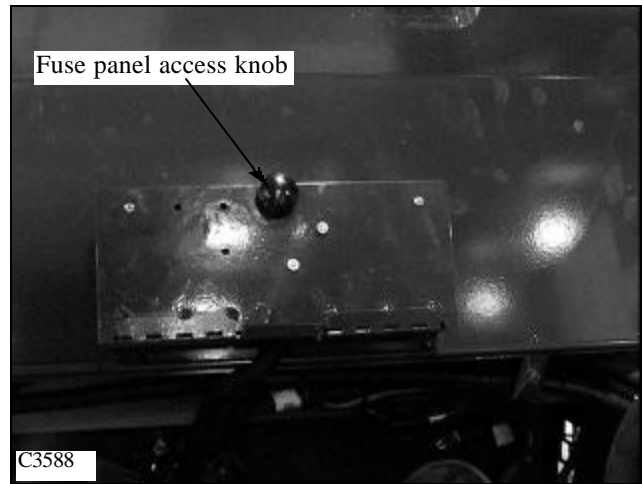

ELECTRICAL PANEL LEGEND.(fig. C2052)

- |   |  |
|---|--|
| 1 Engine harness                                  | 7 Option (10Amp, YL / WH)                |
| 2 Engine Shut Off (15 Amp, RED)                   | 8 Manifold Heater Relay (40 Amp)         |
| 3 Power Inlet From Ignition Switch Acc (BLK / WH) | 9 Option (10 Amp YL)                     |
| 4 Grounding Point (LT GRN)                        | 10 Auxiliary Solenoid (10 Amp, RED / YL) |
| 5 Safety Switches (15 Amp, OR / WH)               | 11 Starter Relay (40 Amp)                |
| 6 Horn / Option (10 Amp, BRN)                     | 12 Alternator (10Amp, BLK / WH)          |
|   | 13 Option (10Amp)                        |



# STARTING CIRCUIT 5.8

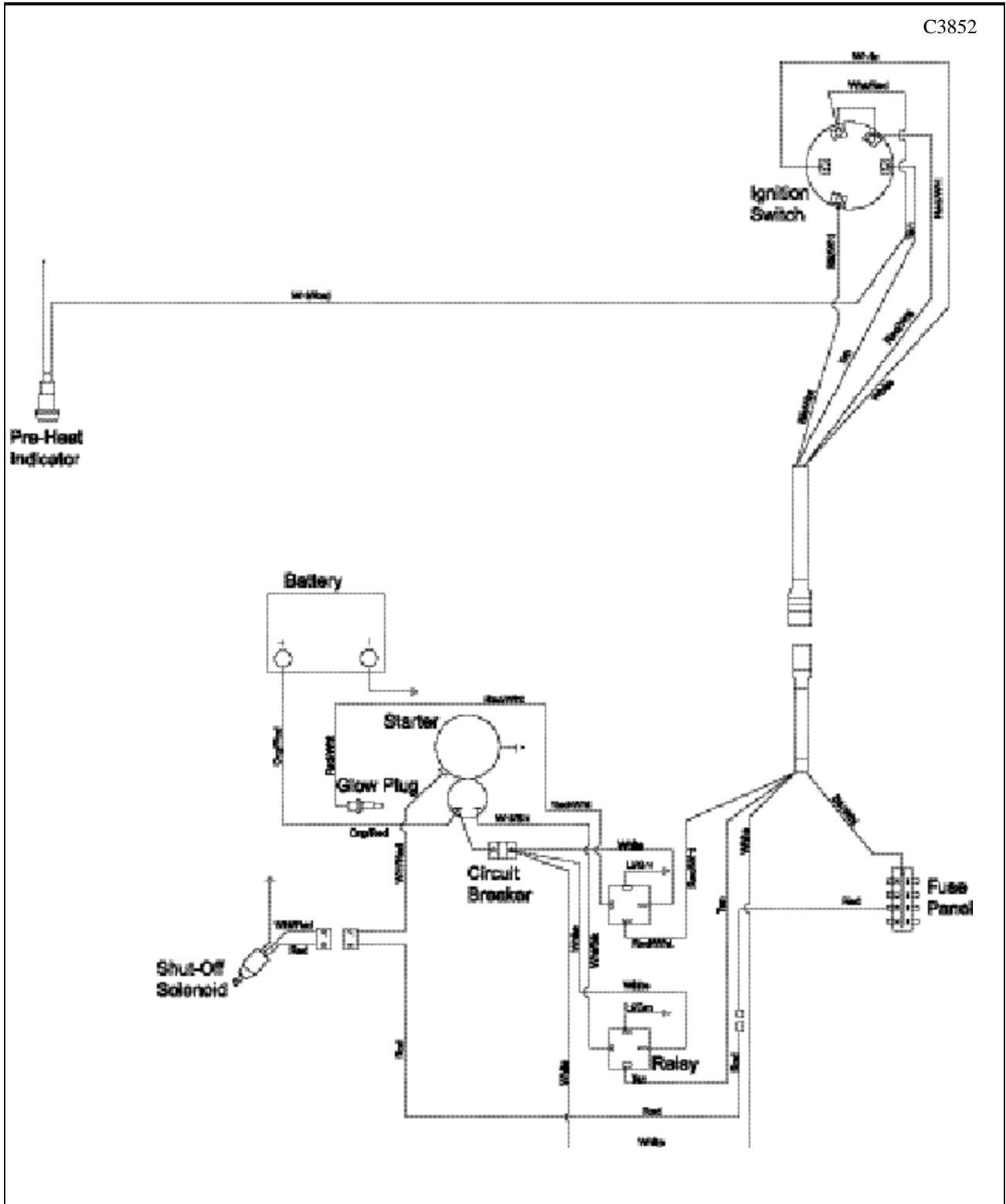

5

# CHARGING CIRCUIT 5.9

C3853

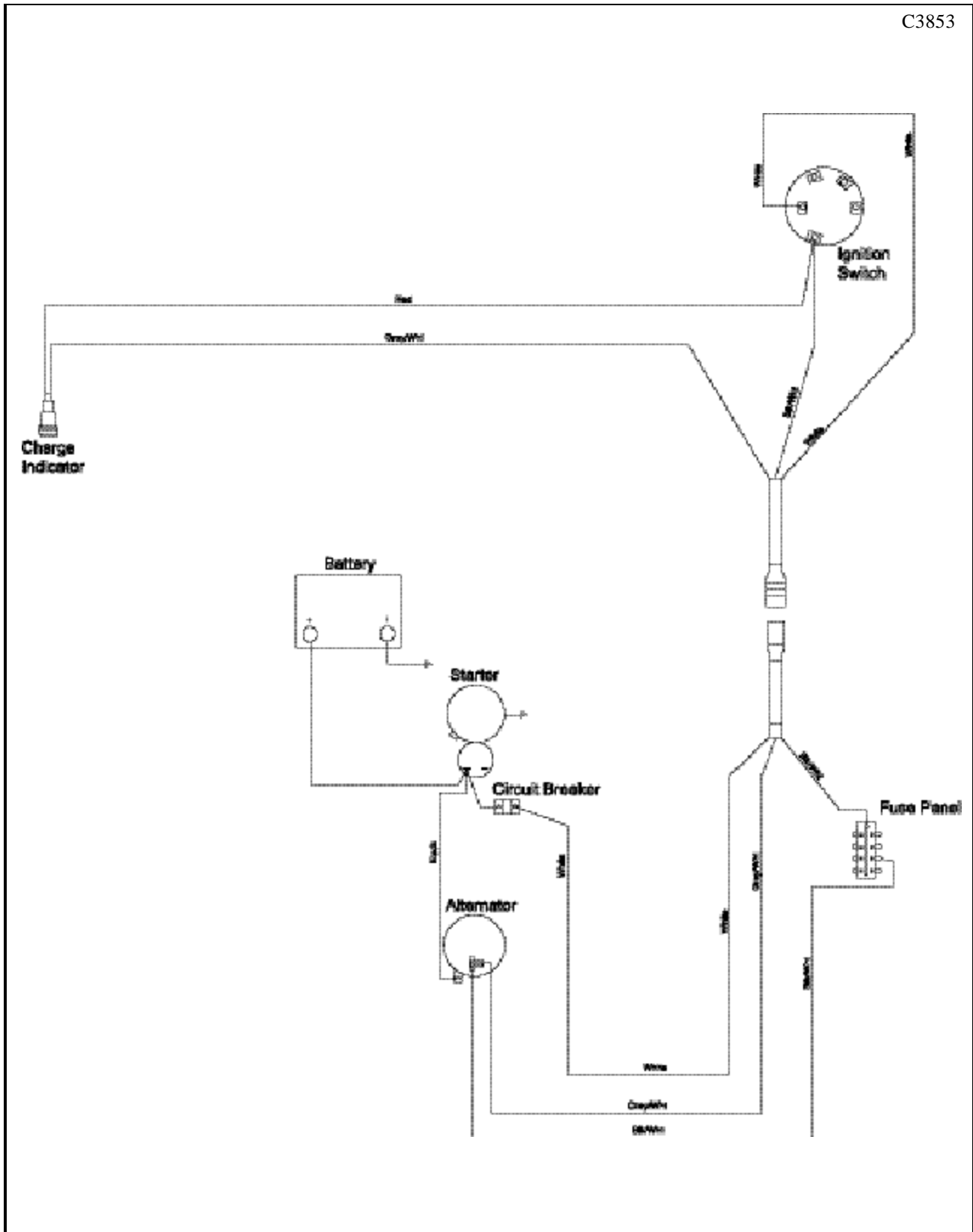

# SAFETY CIRCUIT 5.10

1700  
175

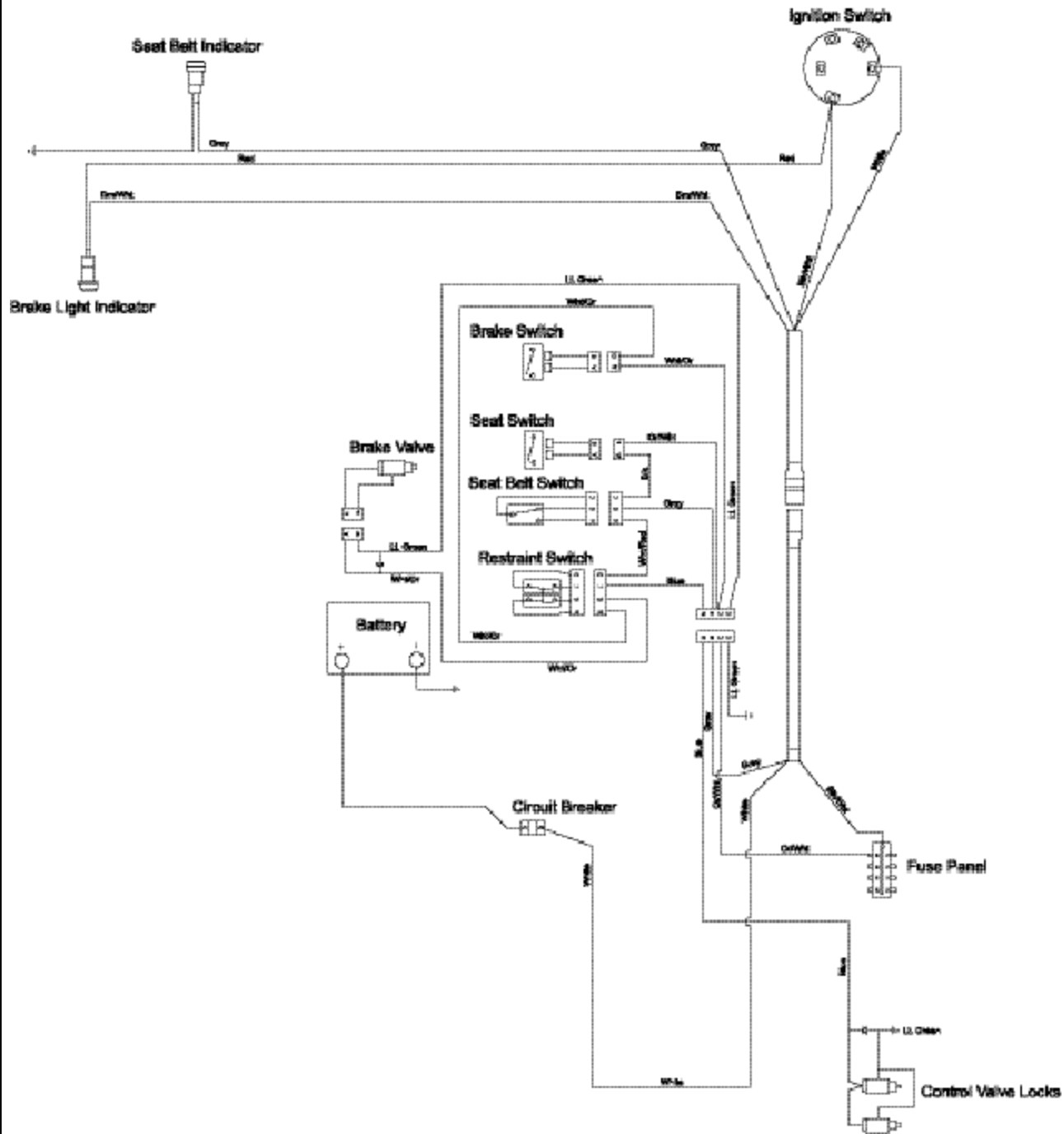

C3855

5

# SAFETY CIRCUIT 5.10

## General Information

The loader is equipped with 3 inter - connected safety switches. These 3 switches operate 2 electric solenoid controlled lock devices. One (1) solenoid coil on the hydraulic brake valve (fig. C3575), one (1) pair of solenoid coils on the hydraulic control valve (fig. C1514) Failure of any one (1) of these switches will prevent the operation of the solenoid coils and loader functions. All 3 must be hooked up, functioning and, if applicable, adjusted correctly.

The bottom of the operators seat is equipped with a pressure sensitive switch. The operator must be in the seat to close the switch and release the parking brake and unlock the control valve functions. (fig. C807) No adjustments required. When removing and replacing the seat, be sure not to pinch the wires under the seat plate.

The seat belt assembly is equipped with a safety switch. The operator must have the seat belt fastened around them in order to close the switch and allow the parking brake to release and the control valve to function. (fig. C3879) No adjustments required.

The restraint bar is equipped with a dual function safety switch. (fig. C3573) With the restraint bar in the raised position, the parking brake is activated, the control valve functions are locked and the activation indicator lights are illuminated on the dash panel.

Lowering the restraint bar releases the parking brake, turns off the indicator lights in the dash panel and releases the locks in the control valve.

The restraint bar must be in the lowered position for the control functions to operate.

The switch must contact the restraint bar when in the lowered position.

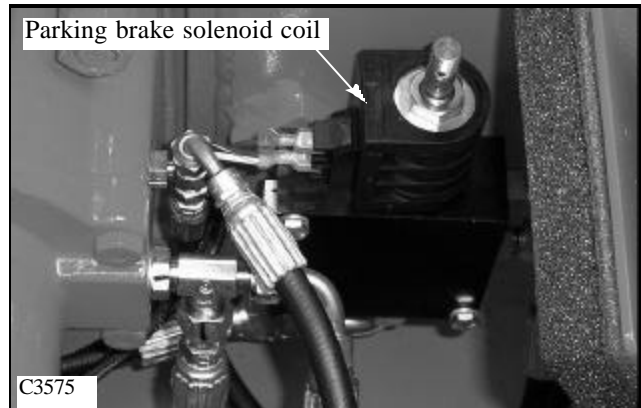
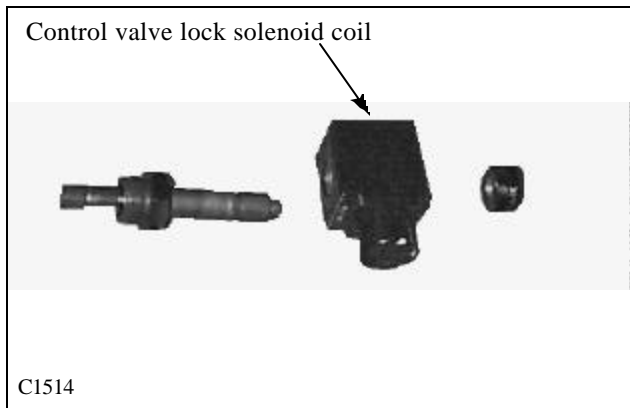
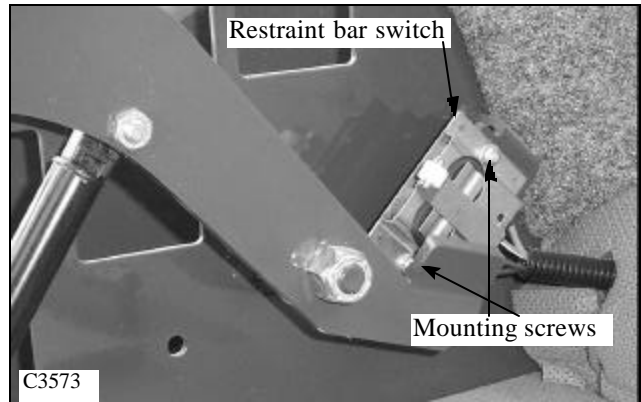
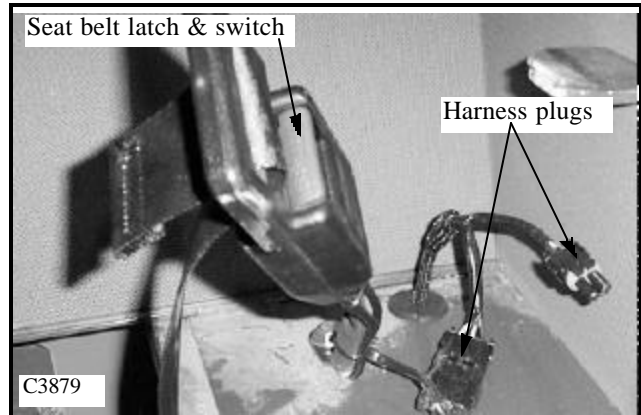
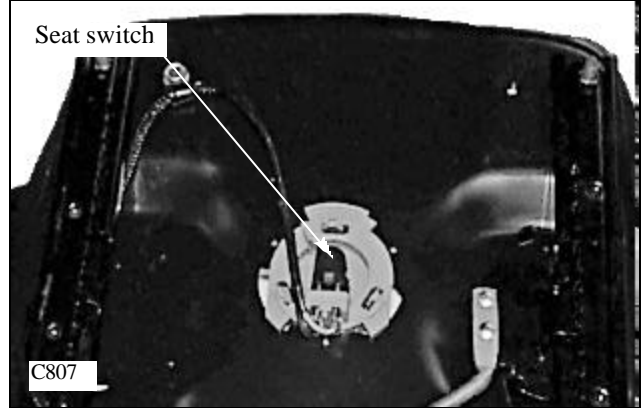

5

# — ELECTRIC AUXILIARY CIRCUIT 5.11 —

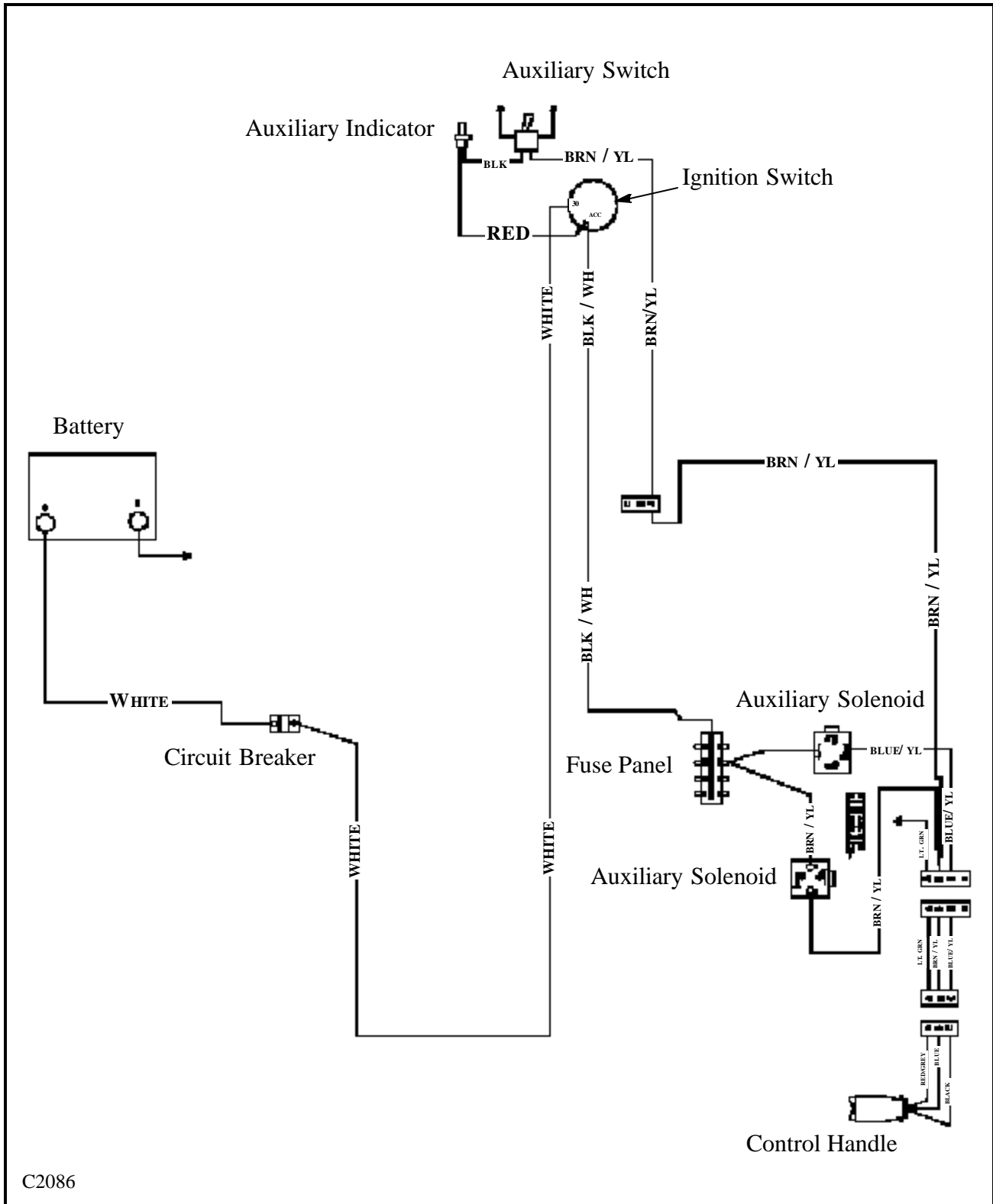

C2086



# ELECTRIC AUXILIARY CIRCUIT 5.11

## THE ERGONOMIC HANDLE CONTROL:

The Ergonomic Handle contains 3 switches: 1 rocker switch (fig. C3861) and 2 push button switches. (fig. 3860)

The handle is normally installed only on the left hand control lever for the 175 loader.

When installed on the L.H. lever:

1. The rocker switch controls the electric aux. functions. Pushing down on the left side of the rocker switch is the forward direction and pushing down on the right side is the reverse direction.
2. L.H. push button is a spare to be used if adding an option.
3. R.H. push button is for the horn.

When installed on the R.H. lever:

1. The rocker switch is used to control the Hi-Flo option. Pushing down on the left side of the rocker switch is the forward direction and pushing down on the right side of the rocker switch is the reverse direction.
2. The L.H. and R.H. buttons are used to turn the signal lights on when the light kit option is installed.

To replace a defective switch:

1. Ensure the ignition switch is in the OFF position.
2. Remove the 4 screws that hold the 2 handle pieces together. (fig. C3862)
3. Remove the L.H. handle piece and pull the switch/wire assembly out of the R.H. handle piece.
4. The original rocker switch has the wires soldered to the terminals of the switch. Take note of the wire color attached to each terminal before removing the wires.
5. The rocker switch has a tab on each end of the switch which needs to be depressed before removing the switch.
6. The rubber rocker cover can be replaced or reused on the replacement rocker switch at this time.
7. Replace the switch and reattach the wires. Proper female spade terminals may be soldered to the wires.

After servicing the control handle be sure the hydraulic flow is circulating in the proper direction. Pushing on the L.H. side of the switch should engage the hydraulic system in the forward direction. The female quick coupling must always be the power out when engaging the control mounted switch in this direction.

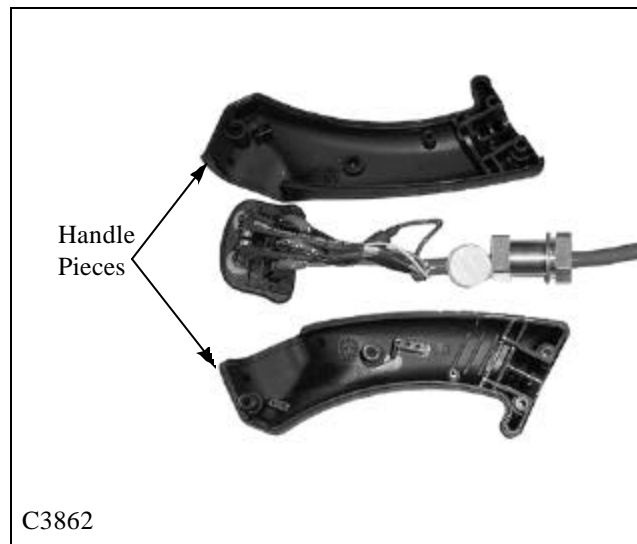
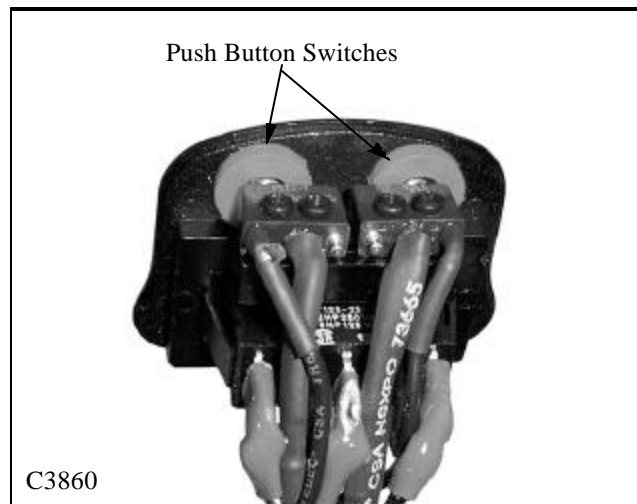
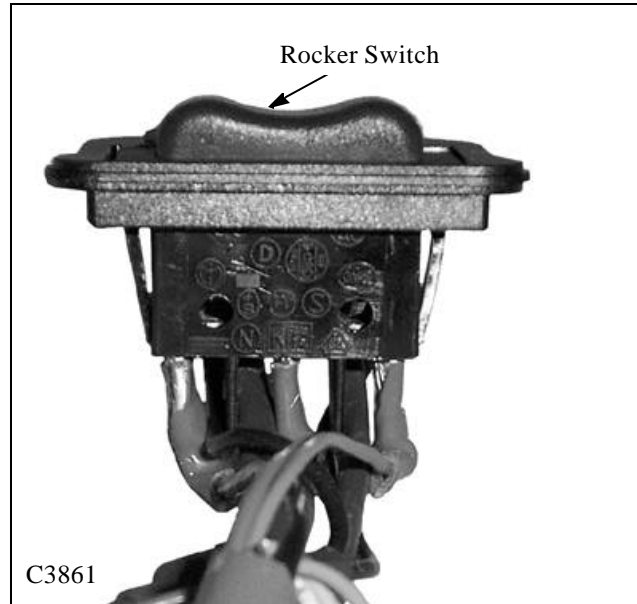

# ACCESSORIES CIRCUIT 5.12

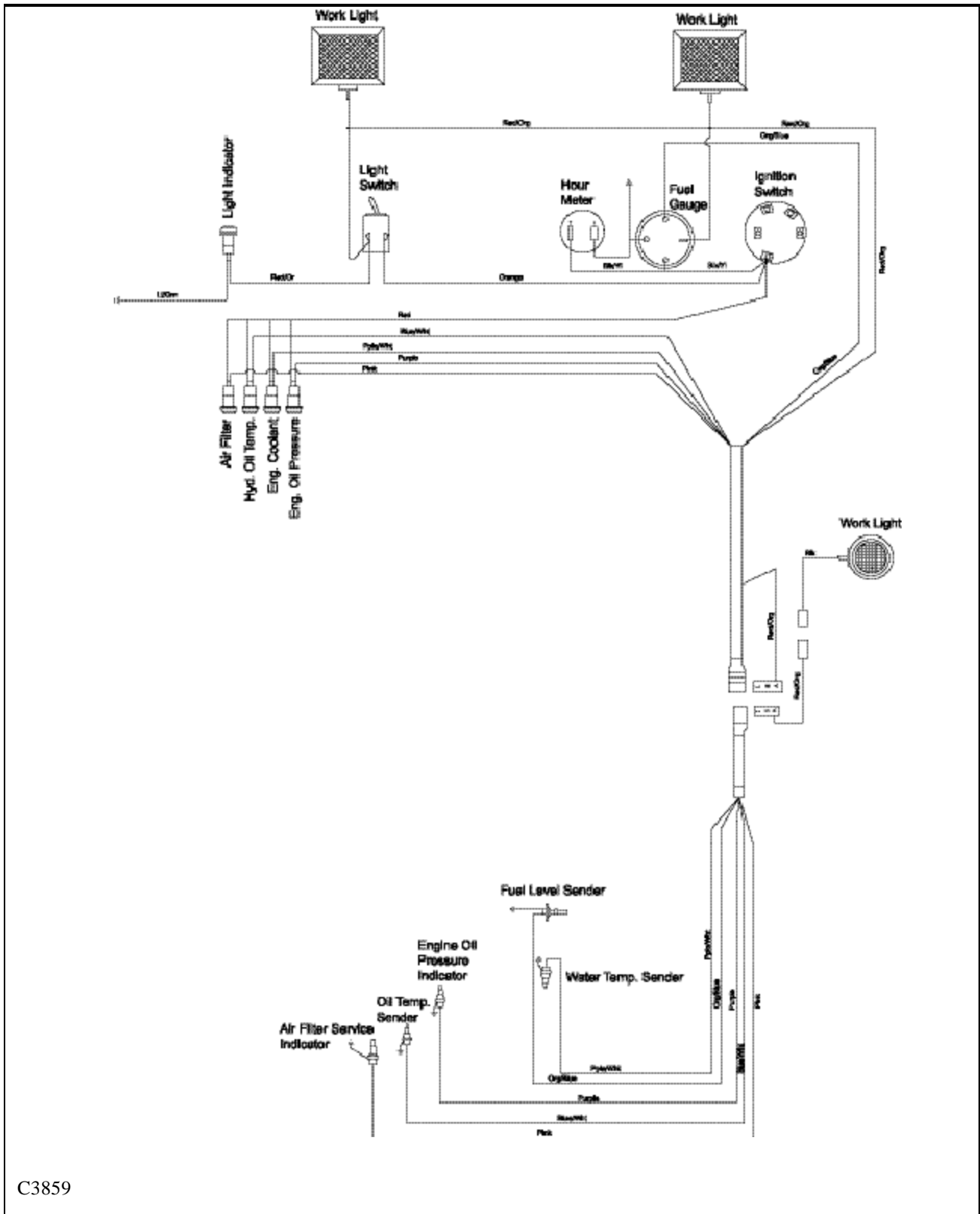

C3859

5

# TROUBLE SHOOTING 5.13

## STARTING SYSTEM

Problem	Cause	Corrective Action	Section
Starter will not engage.	Battery discharged.	Check the battery and charge or replace.	5.6
	Loose or disconnected wiring.	Verify continuity of starting circuit. Check and repair.	
	Defective ignition switch.	Check the switch and replace if necessary.	5.4
	Defective starter solenoid.	Check and replace if necessary. Kubota repair manual P / N 40916.	Kubota repair manual
	Defective relay.	Check and replace.	5.7
	Defective starter.	Check and replace if necessary.	Kubota repair manual
Starter motor turns but does not engage.	Defective overrunning clutch or low battery charge.	Replace starter or parts. Check the battery and charging system. Kubota repair manual P / N 40916.	Kubota repair manual
Pinion engages but engine does not turn over.	Defective starter.	Check and replace. Kubota repair manual P / N 40916.	Kubota repair manual
	Low battery charge.	Check and repair.	5.6
	Engine seizure.	Check and replace.	7
	Hydrostatic pump failure.	Check and replace.	2
Starter motor rotates a full speed before pinion engages.	Defective pinion spring.	Check and replace. Kubota repair manual P / N 40916.	Kubota repair manual
Starter remains engaged after the engine has started.	Faulty ignition switch.	Check and replace.	5.4
	Defective solenoid.	Check and replace. Kubota repair manual P / N 40916.	Kubota repair manual

## SAFETY LOCKING MECHANISM

Problem	Cause	Corrective Action	Section
Control locks will not release.	Blown fuse.	Check fuse and replace with 15 Amp.	5.7
	Safety switch out of adjustment or defective.	Remove the seat, check and adjust or replace.	5.10
	Defective lock solenoid.	Check and replace.	2 / 5.10
	Defective lock mechanism.	Check and replace.	1.4 / 5.10
	Short in wiring harness.	Check for proper grounding, repair or replace harness.	





# TROUBLE SHOOTING 5.13

## CHARGING SYSTEM

Problem	Cause	Corrective Action	Section
Battery low in charge.	Faulty wiring or connections.	Check and repair or replace.	
	Drive belt slipping.	Check and adjust.	7
	Defective battery.	Test battery and replace if necessary.	5.6
	Defective alternator or regulator.	Check charging output. Repair or replace if necessary. (see Kubota manual Thomas p / n 40916)	Kubota repair manual
Alternator overcharging and battery overheats.	Defective battery.	Test battery and replace if necessary.	
	Defective regulator	Check charging output. Replace if necessary. (see Kubota repair manual Thomas p / n 40916)	Kubota repair manual
Low or no output voltage from alternator.	Drive belt slipping.	Check and adjust.	7
	Faulty wiring or connections.	Check and repair or replace.	
	Defective alternator or regulator.	Check charging output. Replace if necessary. (see Kubota repair manual Thomas p / n 40916)	Kubota repair manual
Charge indicator light flickers or runs dim.	Faulty wiring or connections.	Check and repair or replace.	
	Dirty alternator slip rings or brushes.	Check and repair or replace. (see Kubota repair manual Thomas p / n 40916)	Kubota repair manual
Charge indicator goes out but becomes brighter as the engine RPM increases.	Faulty wiring or connections.	Check and repair or replace.	
Charge indicator light is on while the engine is operating.	Drive belt slipping.	Check and adjust.	7
	Defective alternator or regulator.	Check charging output. Replace if necessary. (see Kubota repair manual Thomas p / n 40916)	Kubota repair manual

