

3. MONITORING SYSTEM

1. CLUSTER

The gauges panel consists of gauges and monitors as shown below, to warn the operator in case of abnormal machine operation or conditions for the appropriate operation and inspection.

- Gauges : Indicate operating status of the machine.
- Warning lamp : Indicate abnormality of the machine.
- Pilot lamp : Indicate operating status of the machine.

※ **The monitor installed on this machine does not entirely guarantee the condition of the machine.**

Daily inspection should be performed according to chapter 6, Maintenance.

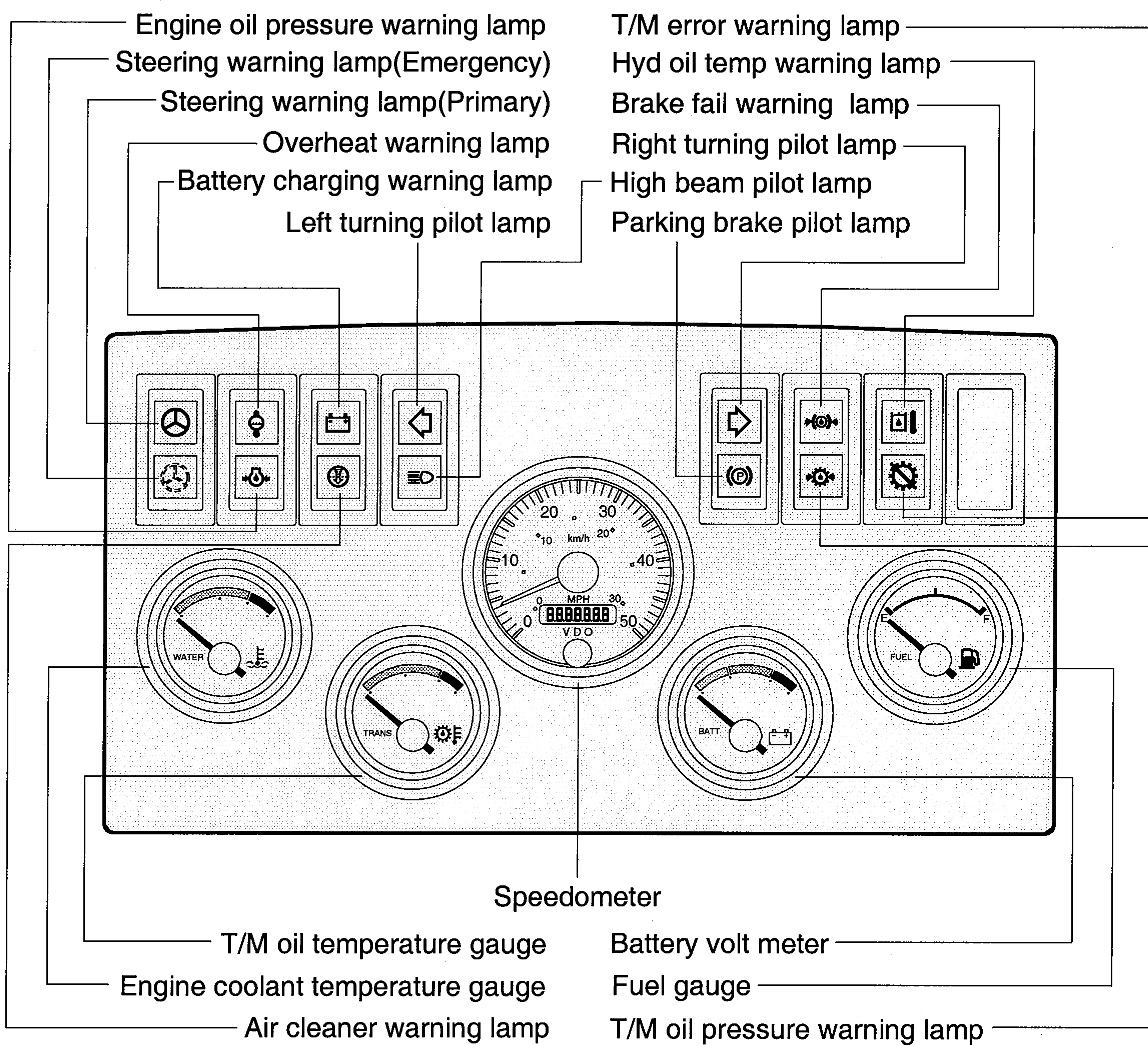

1) SPEEDOMETER

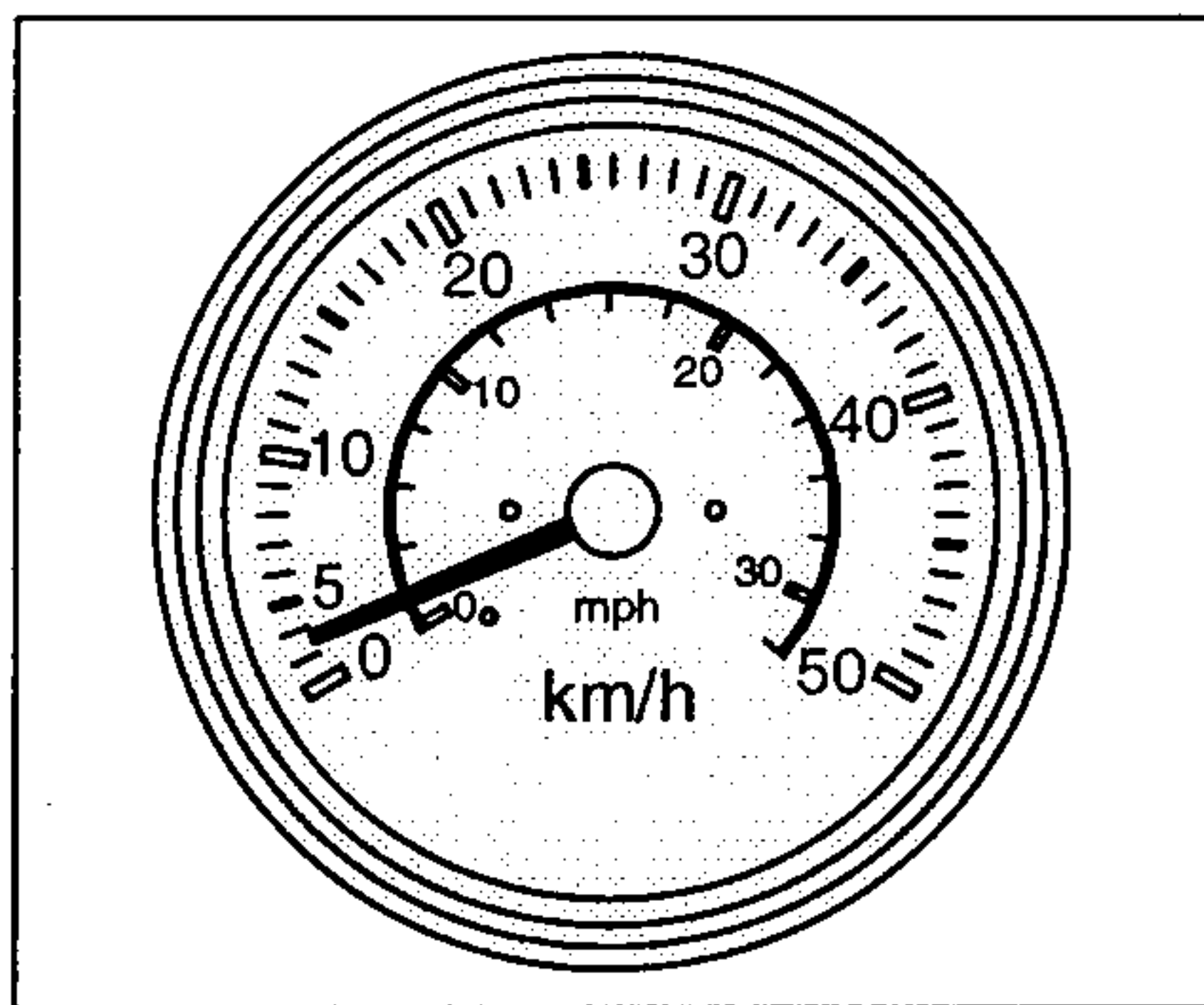

(1) Specification

Input(Hz)	Input pulse
1km = 26.2Hz	

(2) Indicated standard

Standard(km/h)	0	20	40
Allowable(km/h)	0	+4.8 0	+4.8 0

2) FUEL GAUGE

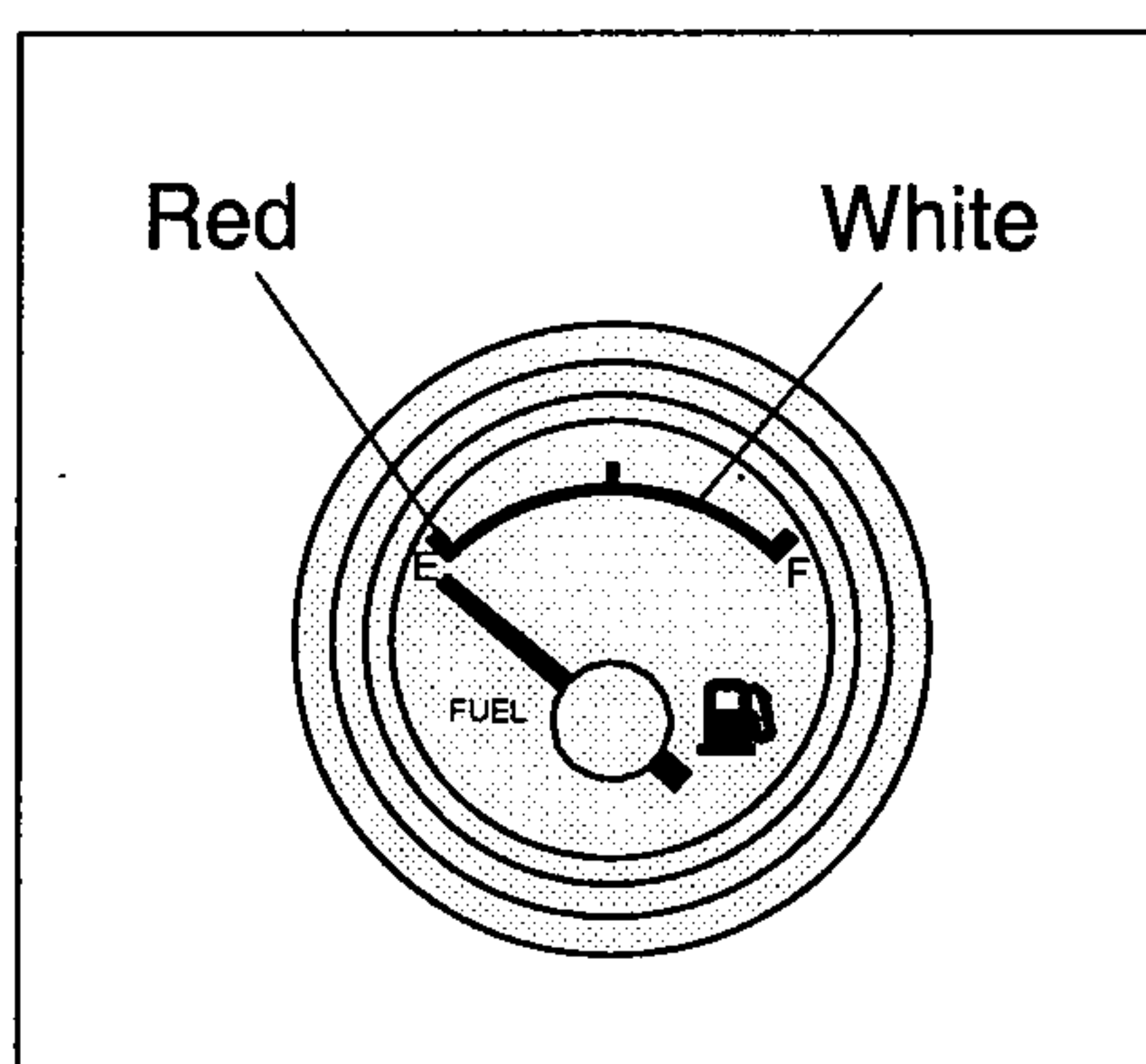

- (1) This gauge indicates the amount of fuel in the fuel tank.
 - (2) Fill the fuel when the red range illuminates.
 - (3) The gauge indicates continuously the current fuel amount even after turn OFF the starting switch. This does not mean that the gauge is out of order.
- ※ **If the gauge illuminates the red range even though the machine is on the normal condition, check the electric device as that can be caused by the poor connection of electricity or sensor.**

Fuel quantity	Tolerance	Resistance(Ω)	Zone
E	+0.7, -0.7	240	Red
F	+2.0, -2.0	33.5	White

3) ENGINE COOLANT TEMPERATURE GAUGE

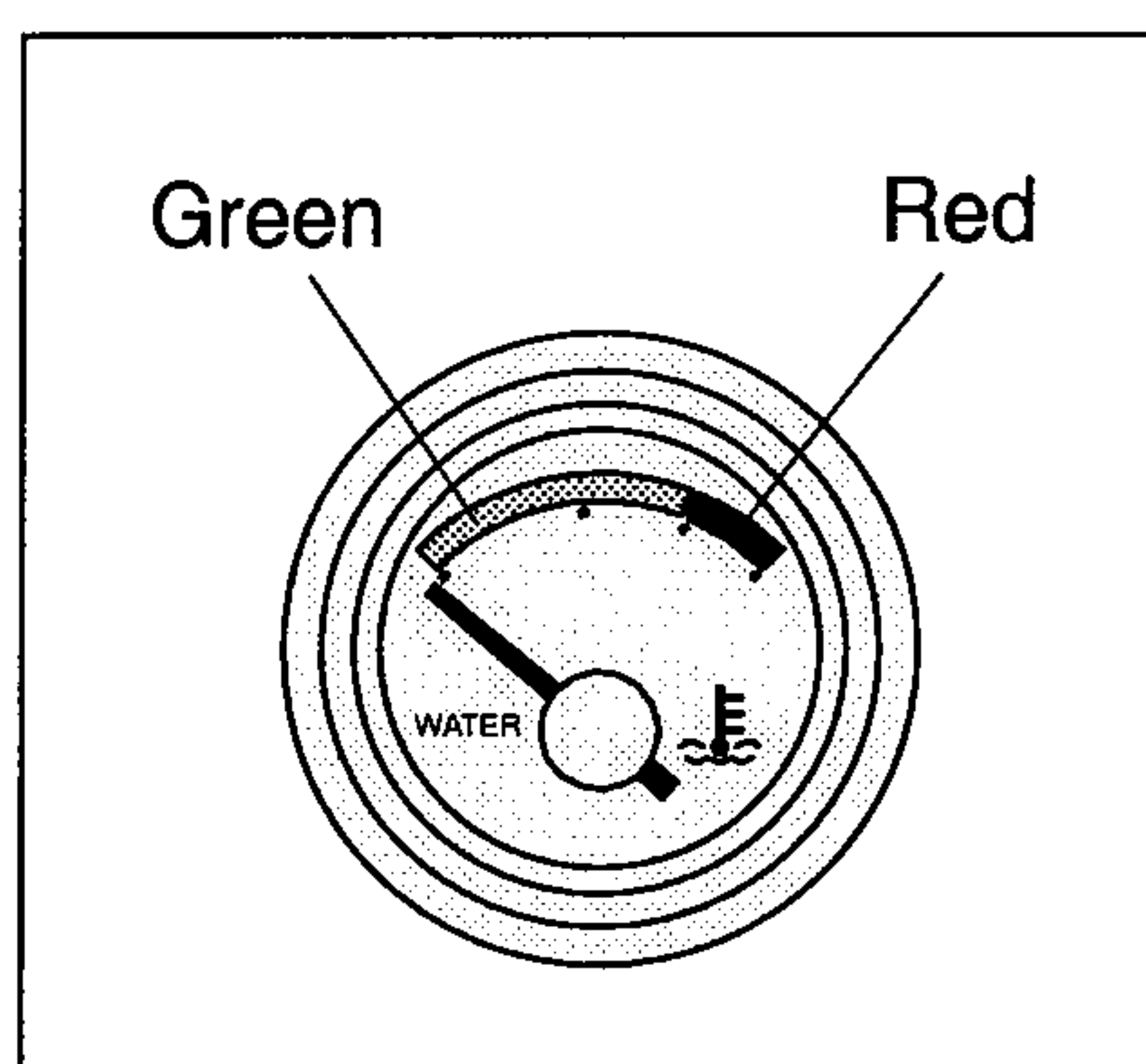

- (1) This indicates the temperature of coolant.
 - Green range : 37-105°C(99-221°F)
 - Red range : 105°C(221°F) Above
- (2) The green range illuminates when operating.
- (3) Keep idling engine at low speed until the green range illuminates, before operation of machine.
- (4) When the red range illuminates, turn OFF the engine, check the radiator and engine.

Temperature (°C)	Tolerance	Resistance (Ω)	Zone
37	+11.7, -13.9	533.2	Green
105	+1.7, -1.8	73.3	Red

4) TRANSMISSION OIL TEMPERATURE GAUGE

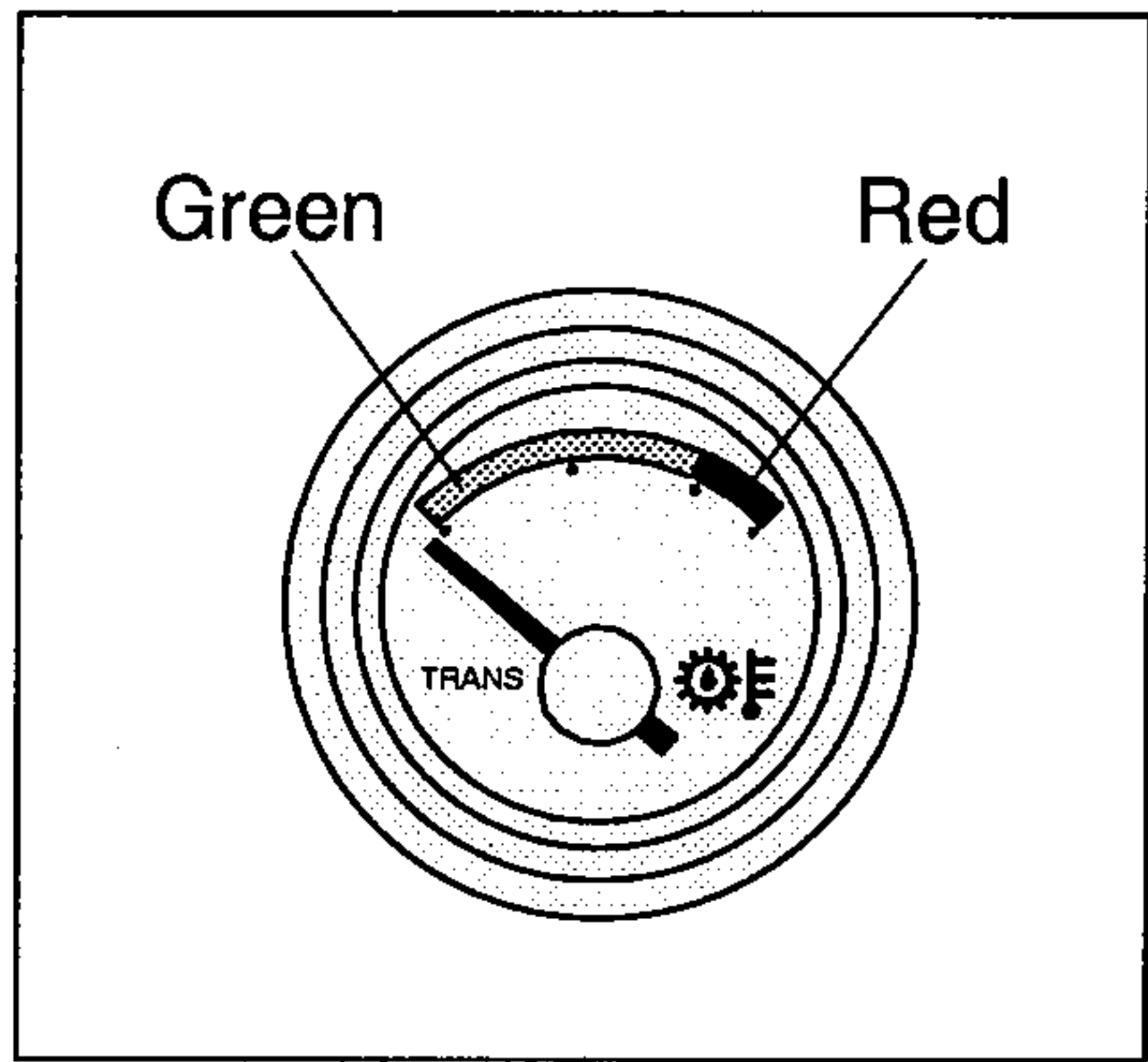

- (1) This range indicates the temperature of transmission oil.
 - Green range : 37-120°C(99-248°F)
 - Red range : 120°C(248°F) Above
- (2) The green range indicates when operating.
- (3) Keep idling engine at low speed until the green range indicates, before operation of machine.
- (4) If the indicator is in the red range, it means the transmission is overheated. Be careful that the indicator does not move into the red range.

Temperature (°C)	Tolerance	Resistance (Ω)	Zone
37	+13.9, -16.7	767.7	Green
120	+2.8, -2.8	65.4	Red

5) BATTERY VOLT METER

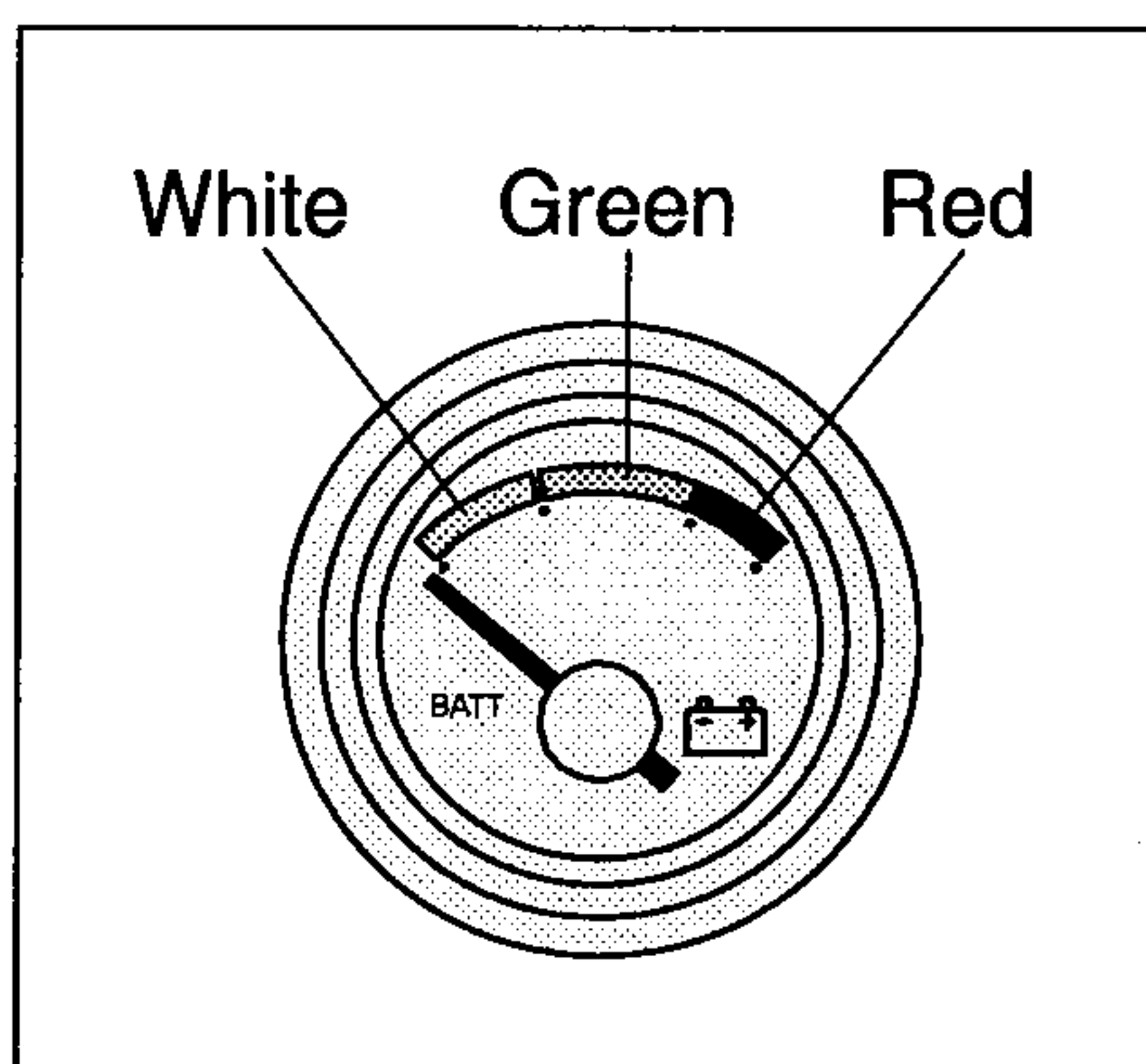

- (1) This gauge indicates the voltage in the charging system when the engine is running.
- (2) If the indicator is below 24V(White range), it means that the electricity is being discharged. If the indicator is above 30V(Red range), an unusually high voltage may damage the alternator. Check the charging system in both cases.

Temperature (°C)	Tolerance	Input voltage (V)	Zone
24	+0.50, -0.50	24	Green
30	+0.25, -0.25	30	Red

6) DIRECTION PILOT LAMP

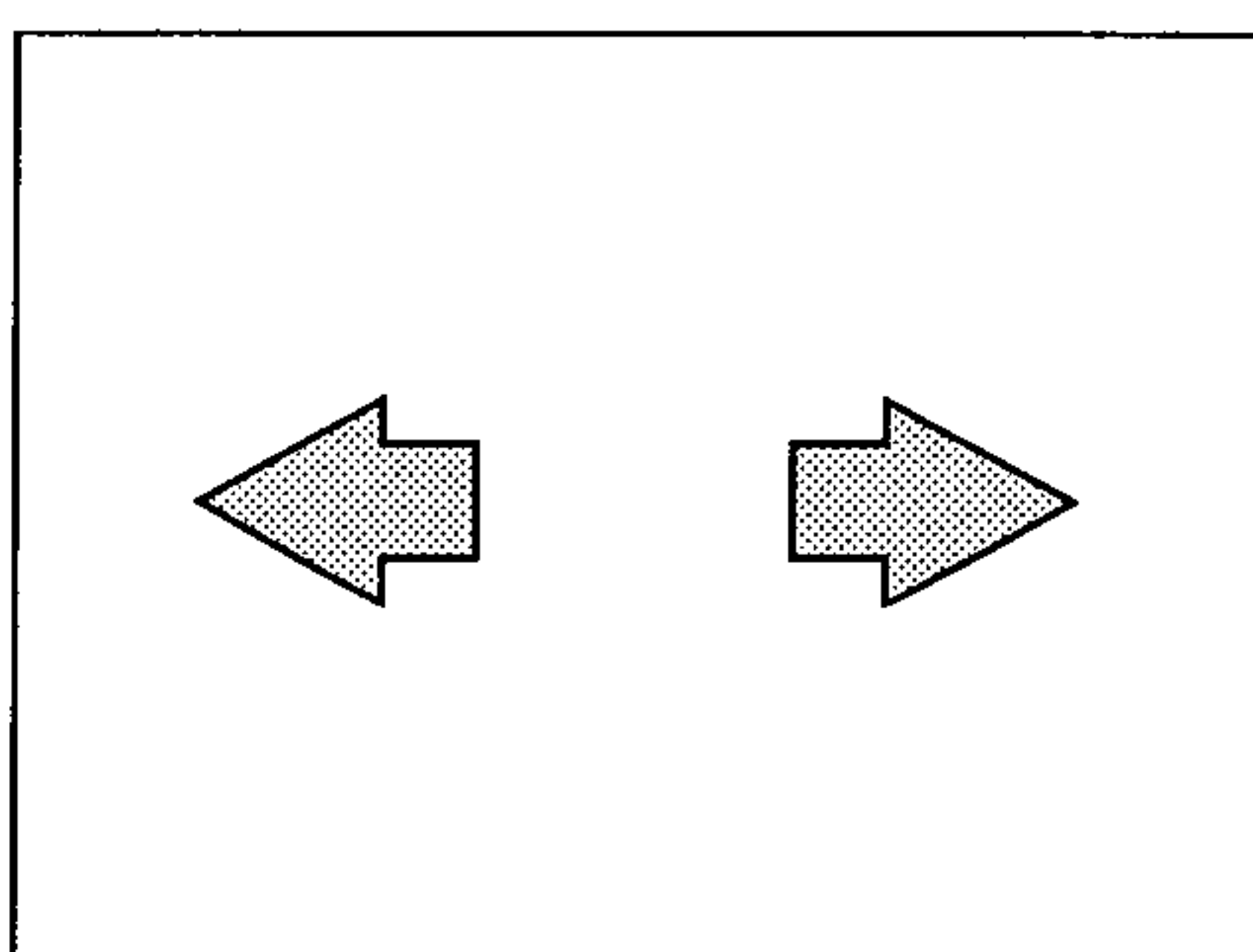

- (1) This lamp flashes when the signal indicator lever is moved.
- (2) When the lamp lights up, the alarm(50dB) sounds.

7) HIGH BEAM PILOT LAMP

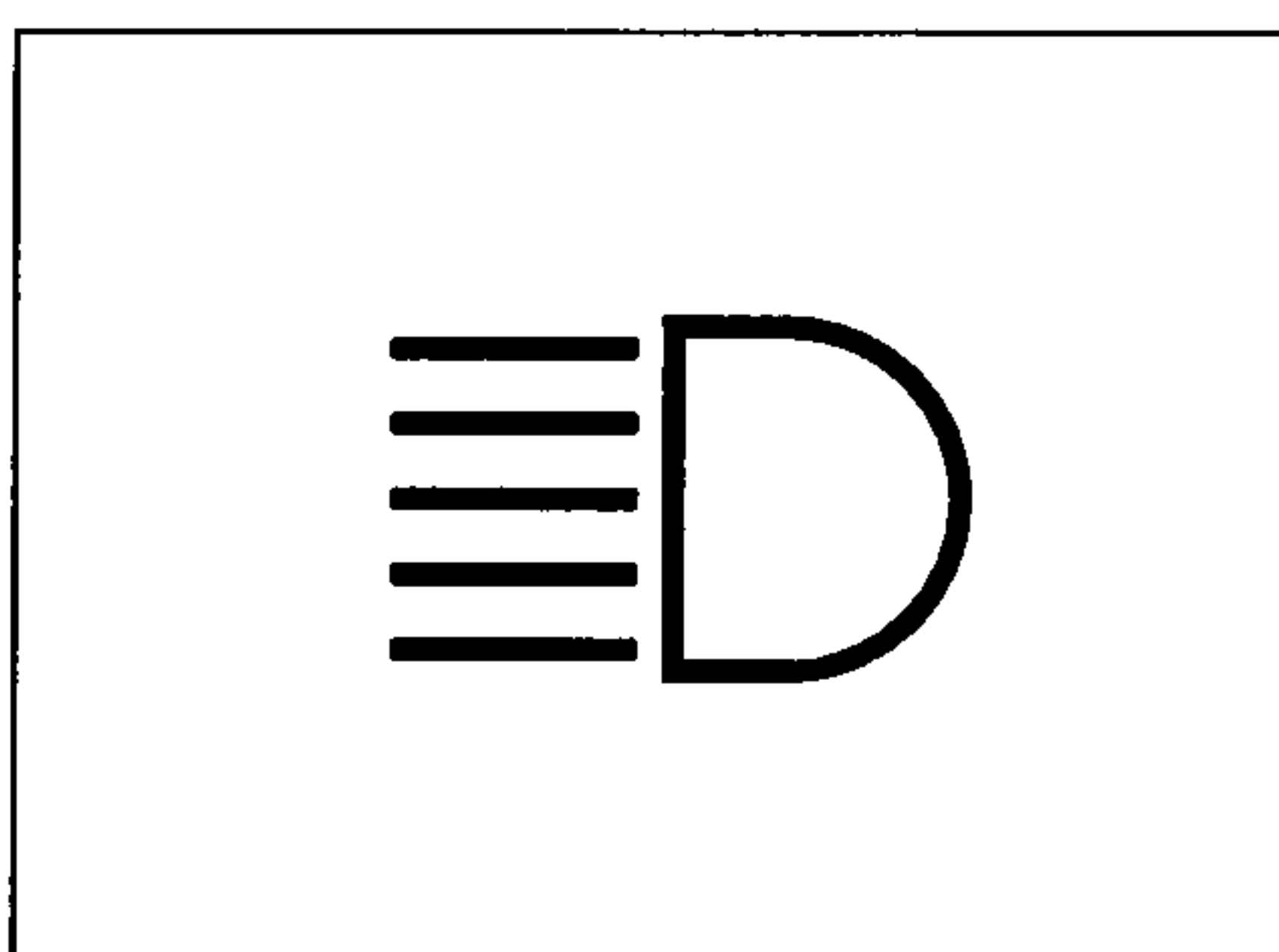

- (1) This lamp works when the illuminating direction is upward.
- (2) This lamp comes ON when the dimmer switch is operated, e.g., when passing another vehicle.

8) PARKING BRAKE PILOT LAMP

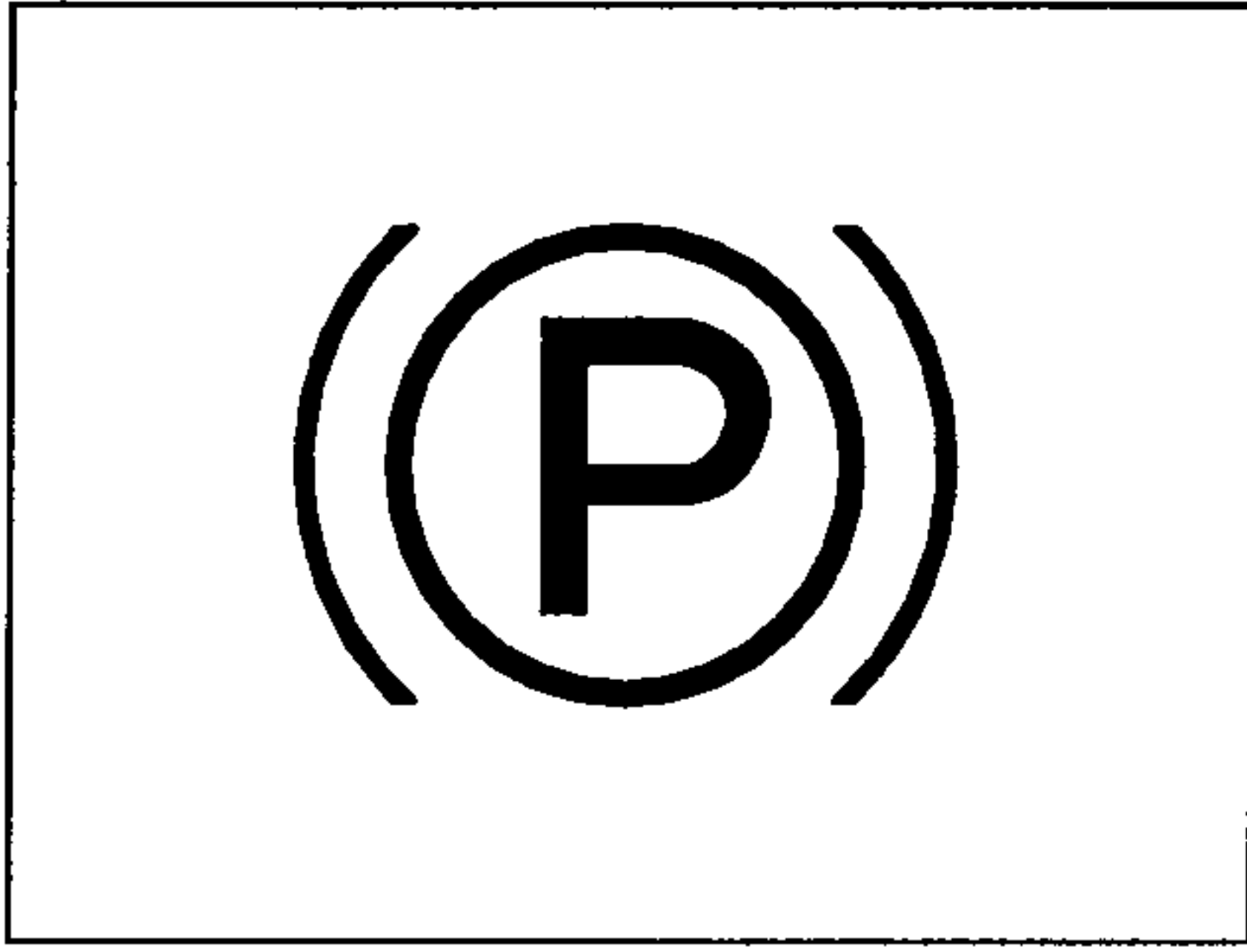

- (1) When the parking brake is actuated, the lamp lights ON.
- ※ **Check the lamp is OFF before driving.**

9) BRAKE FAIL WARNING LAMP

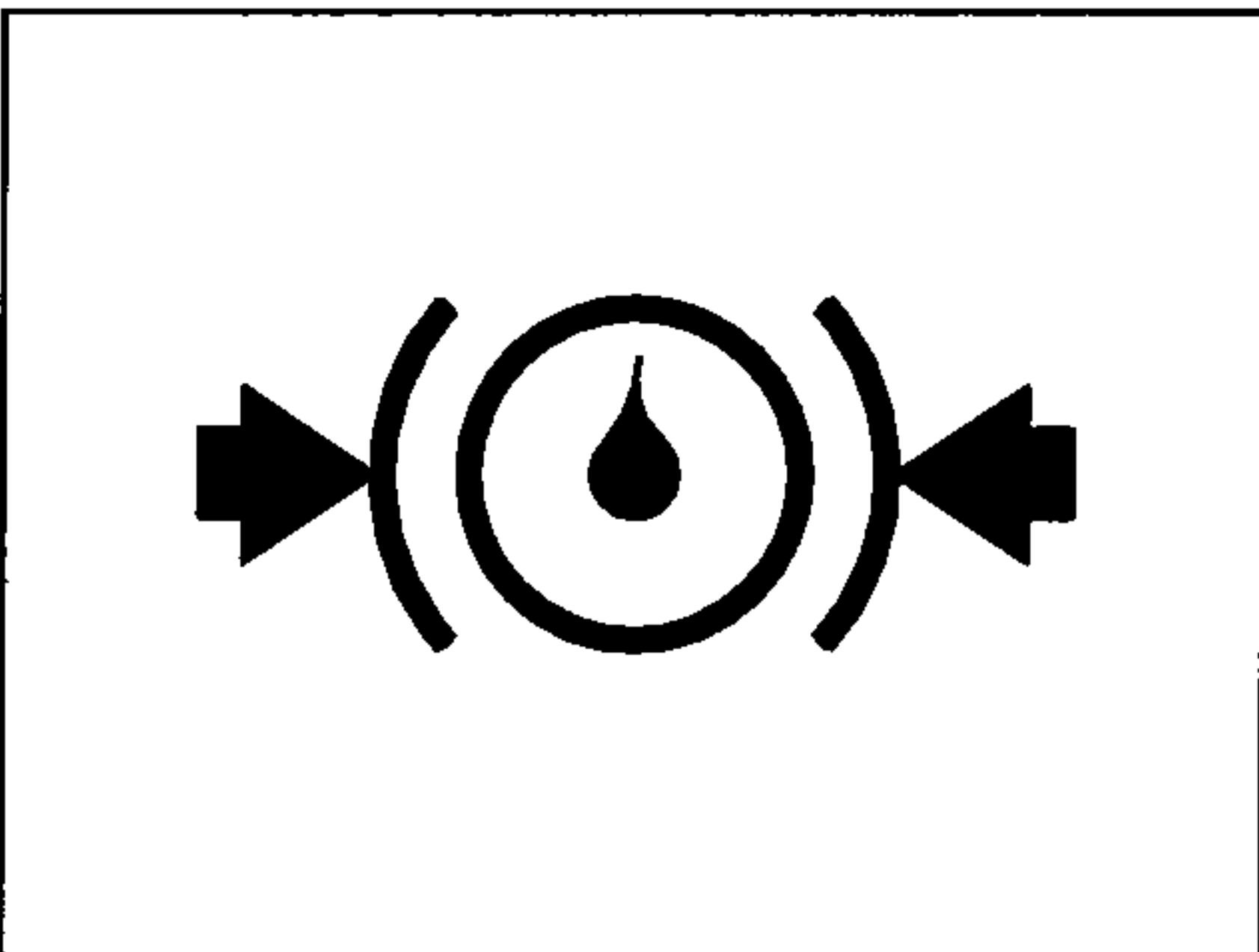

- (1) The lamp lights ON when the oil pressure of service brake drops below the normal range.
- (2) When the lamp is ON, stop the engine and check for its cause.
- ※ **Do not operate until any problems are corrected.**

10) TRANSMISSION OIL PRESSURE WARNING LAMP

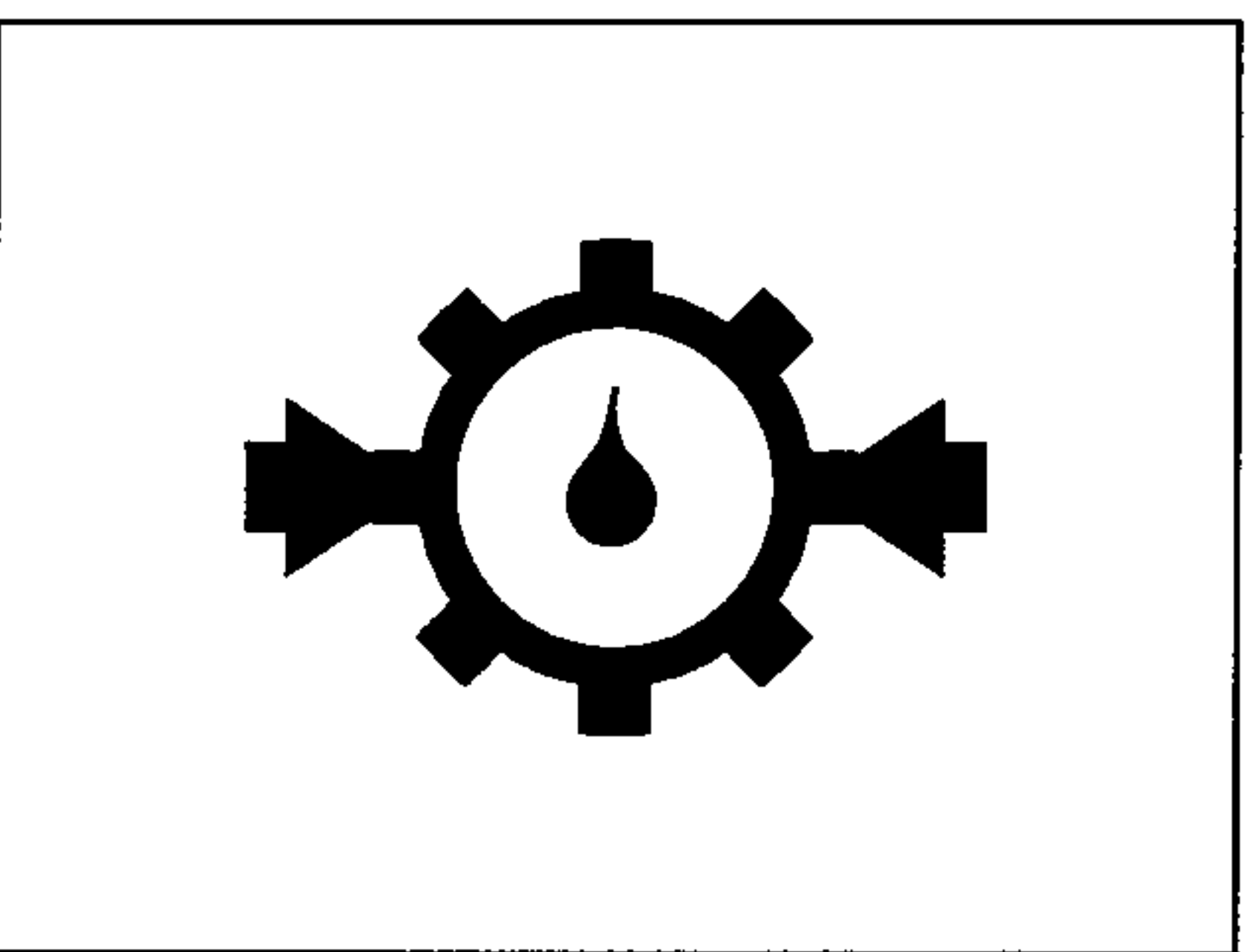

- (1) The lamp lights ON when the oil pressure of the transmission drops.
- (2) When the lamp is ON, stop the engine and check the transmission system.

11) AIR CLEANER WARNING LAMP

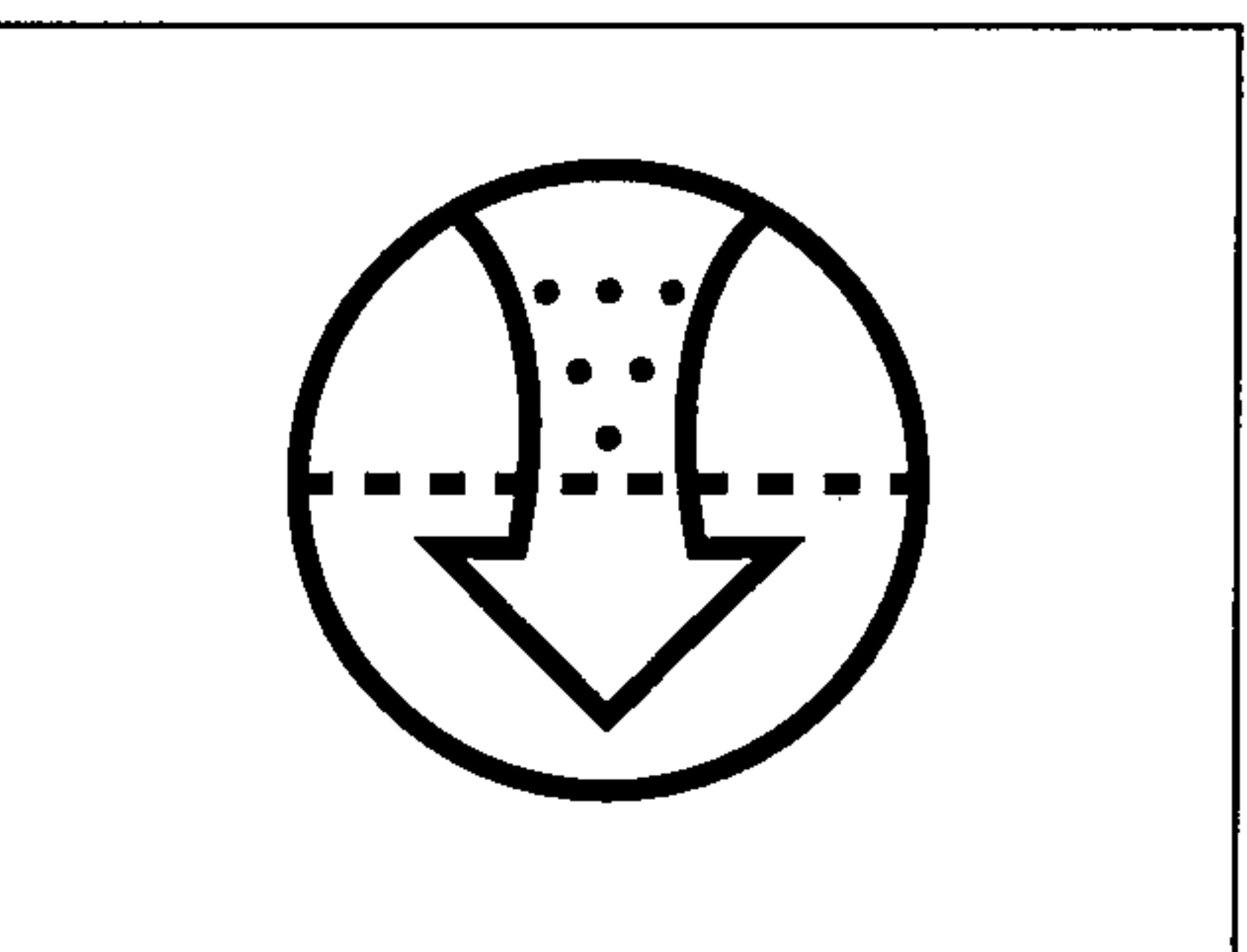

- (1) This lamp operates by the vacuum caused inside when the filter of air cleaner is clogged.
- (2) Check the filter and clean or replace it when the lamp operates.

12) BATTERY CHARGING WARNING LAMP

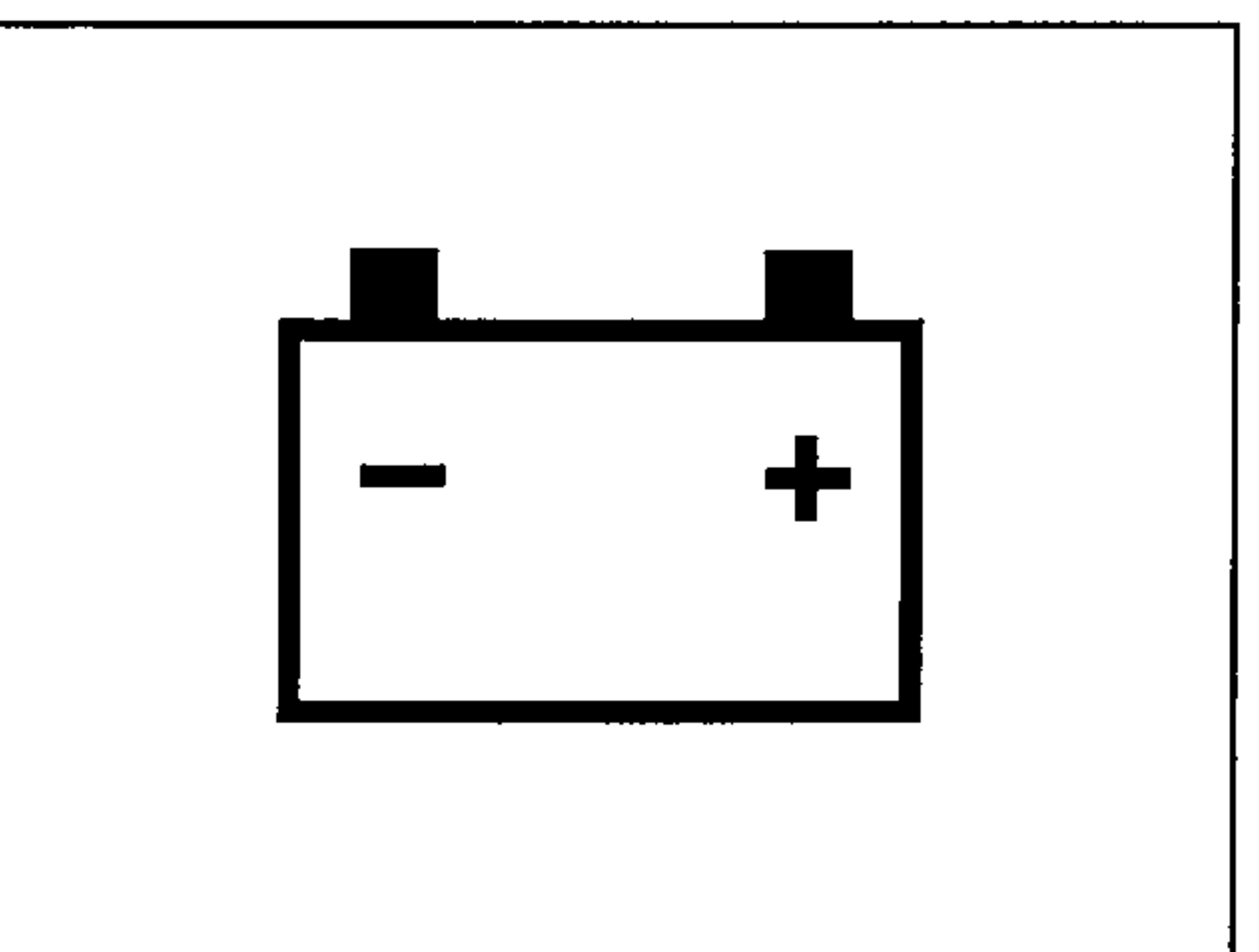

- (1) This lamp is ON when key ON, it is turned OFF after starting the engine.
- (2) Check the battery charging circuit when this lamp comes ON, during engine operation.

13) ENGINE OIL PRESSURE WARNING LAMP

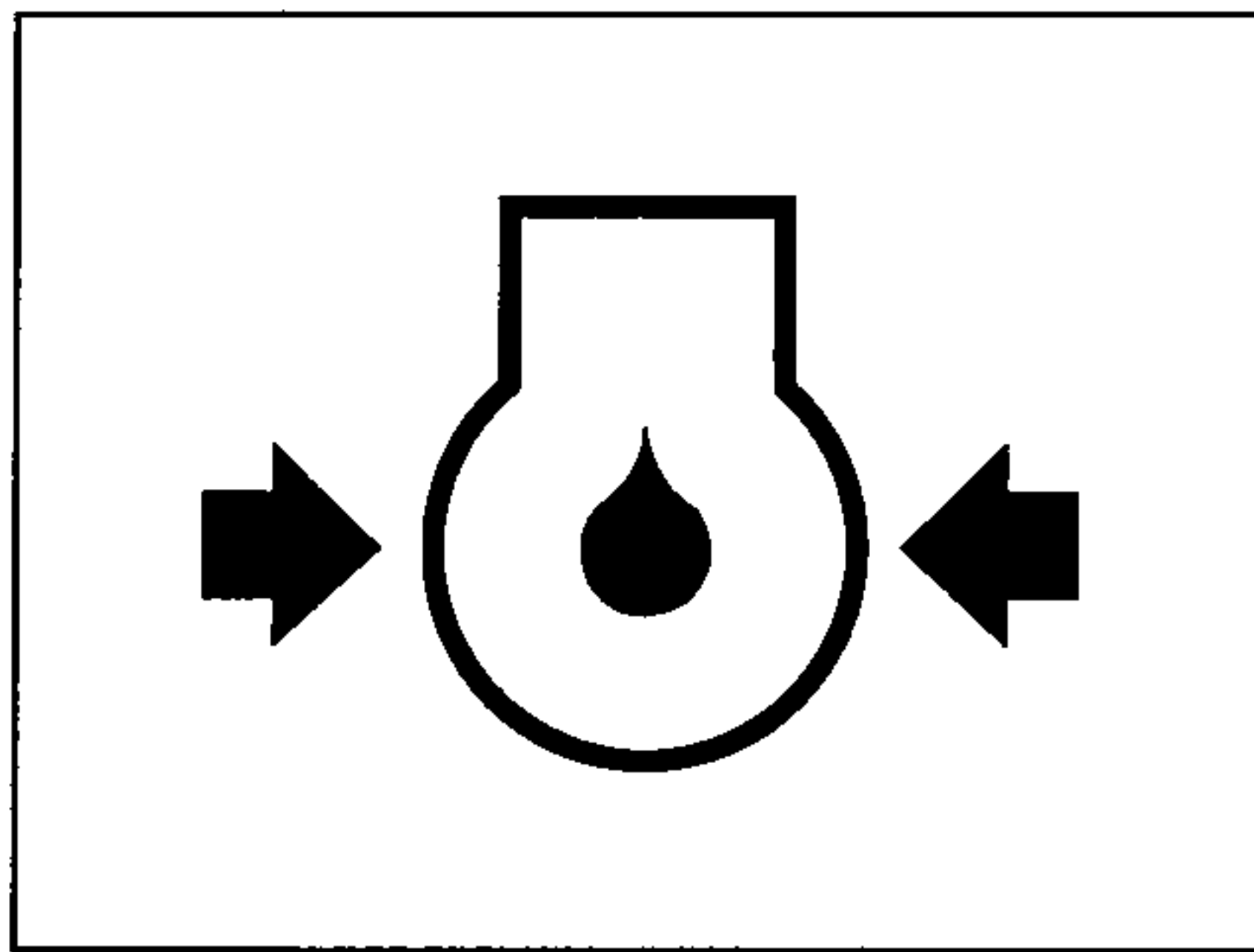

- (1) If lamp comes ON during engine operation, shut OFF engine immediately. Check oil level.

14) OVERHEAT WARNING LAMP

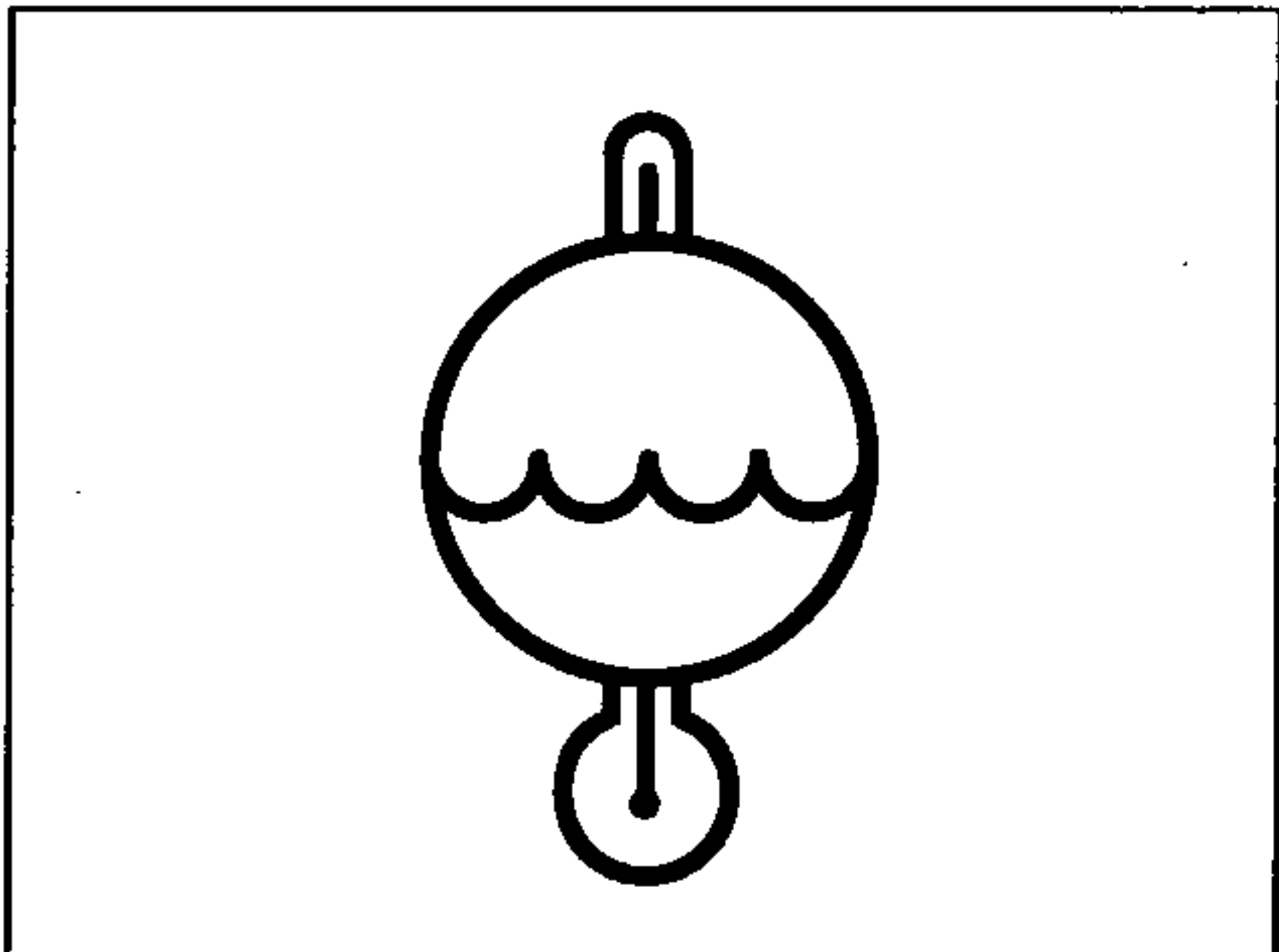

- (1) This lamp is turned ON when the temperature of cooling water is over the normal temperature(110°C, 230°F).
- (2) Check the cooling system when the lamp is ON.

15) HYDRAULIC OIL TEMP WARNING LAMP

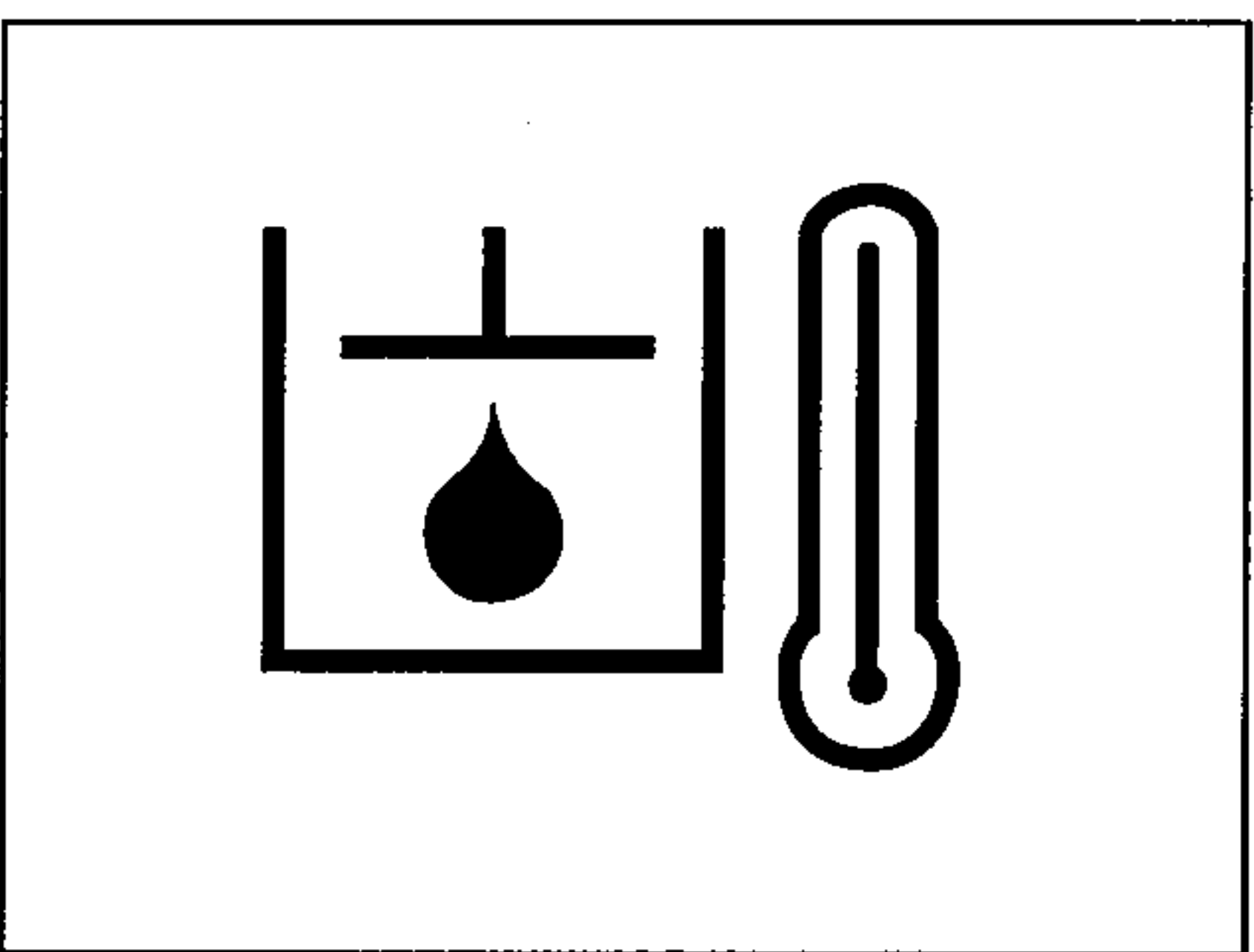

- (1) This warning lamp operates and the buzzer sounds when the temperature of hydraulic oil is over 105°C(221°F).
- (2) Check the hydraulic oil level when the lamp is turned ON.
- (3) Check for debris between oil cooler and radiator.

16) TRANSMISSION ERROR WARNING LAMP

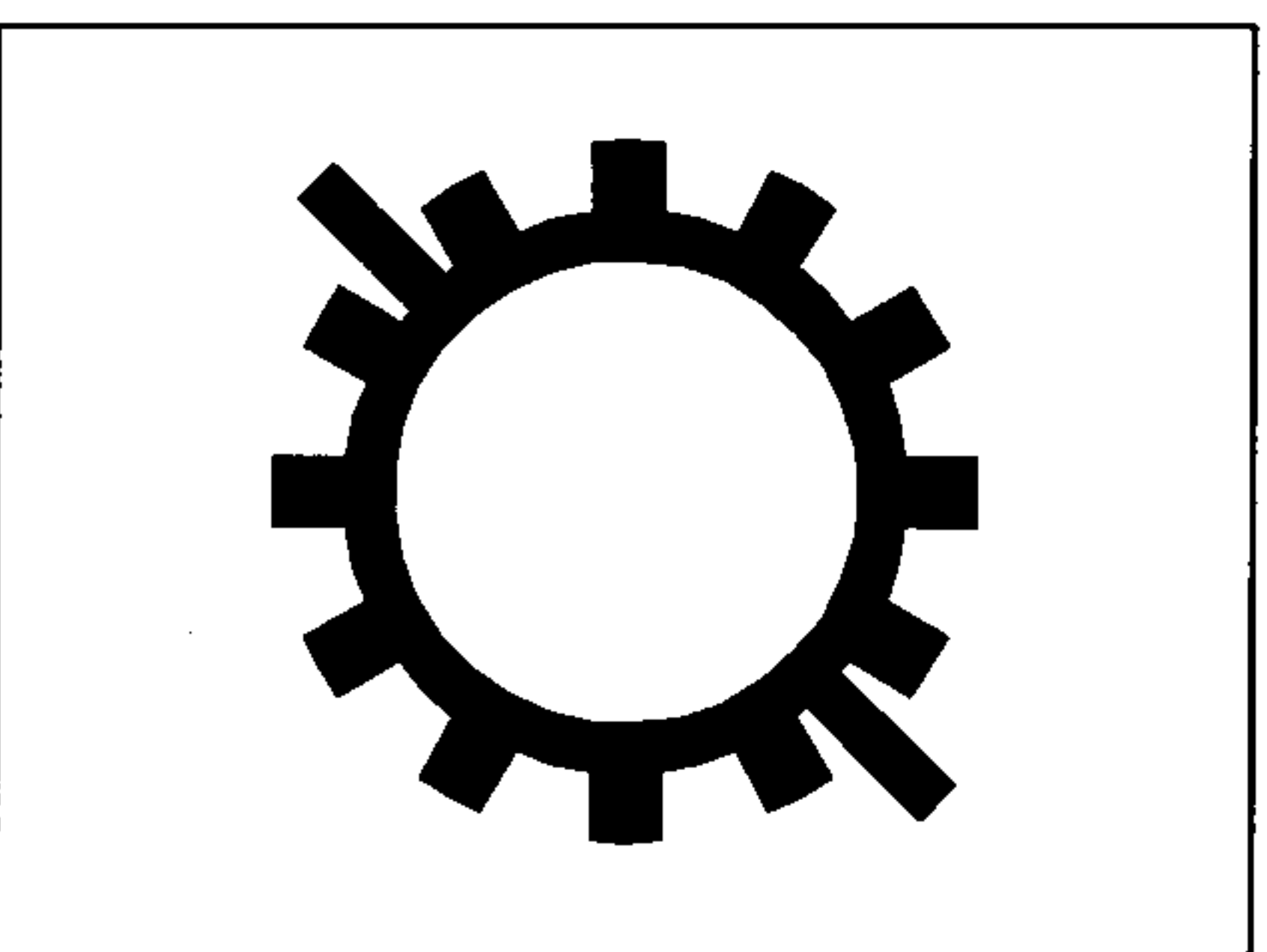

- (1) This lamp lights ON and the transmission error display show the wrench with the error codes when a error occurs in the transmission.
- (2) Immediately pull the machine to a convenient stop. Stop the engine. Investigate the cause.
 - ※ **Consult a HYUNDAI dealer to investigate the cause.**
 - ※ **Do not operate until the cause has been corrected.**

17) STEERING WARNING LAMP(Option)

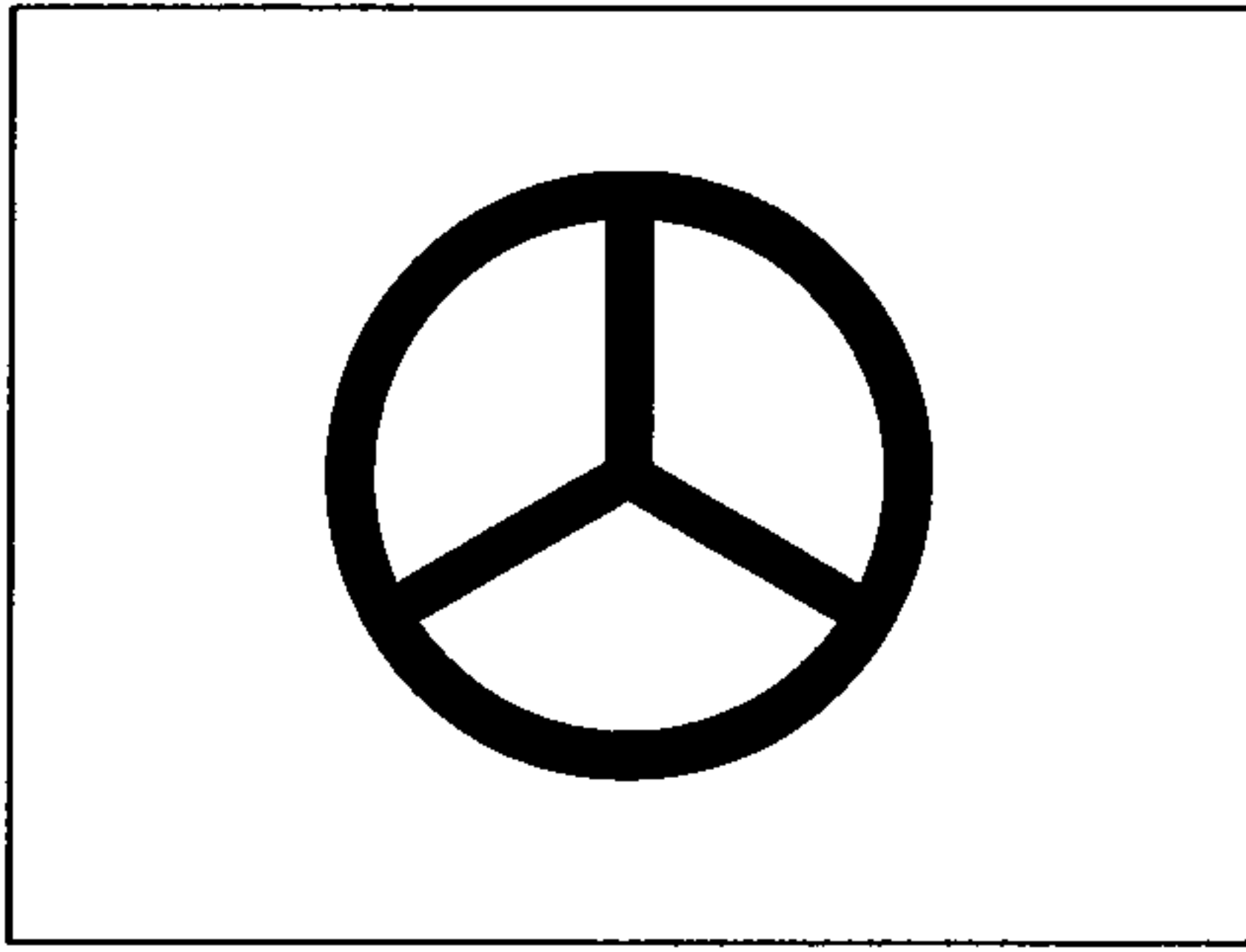

(1) Primary

If the oil pressure in the steering pump drops, the lamp will light up. If this lamp flashes during operation, the action alarm should sound.

- ※ **If the lamp lights up, immediately pull the machine to a safe place and stop the machine.**

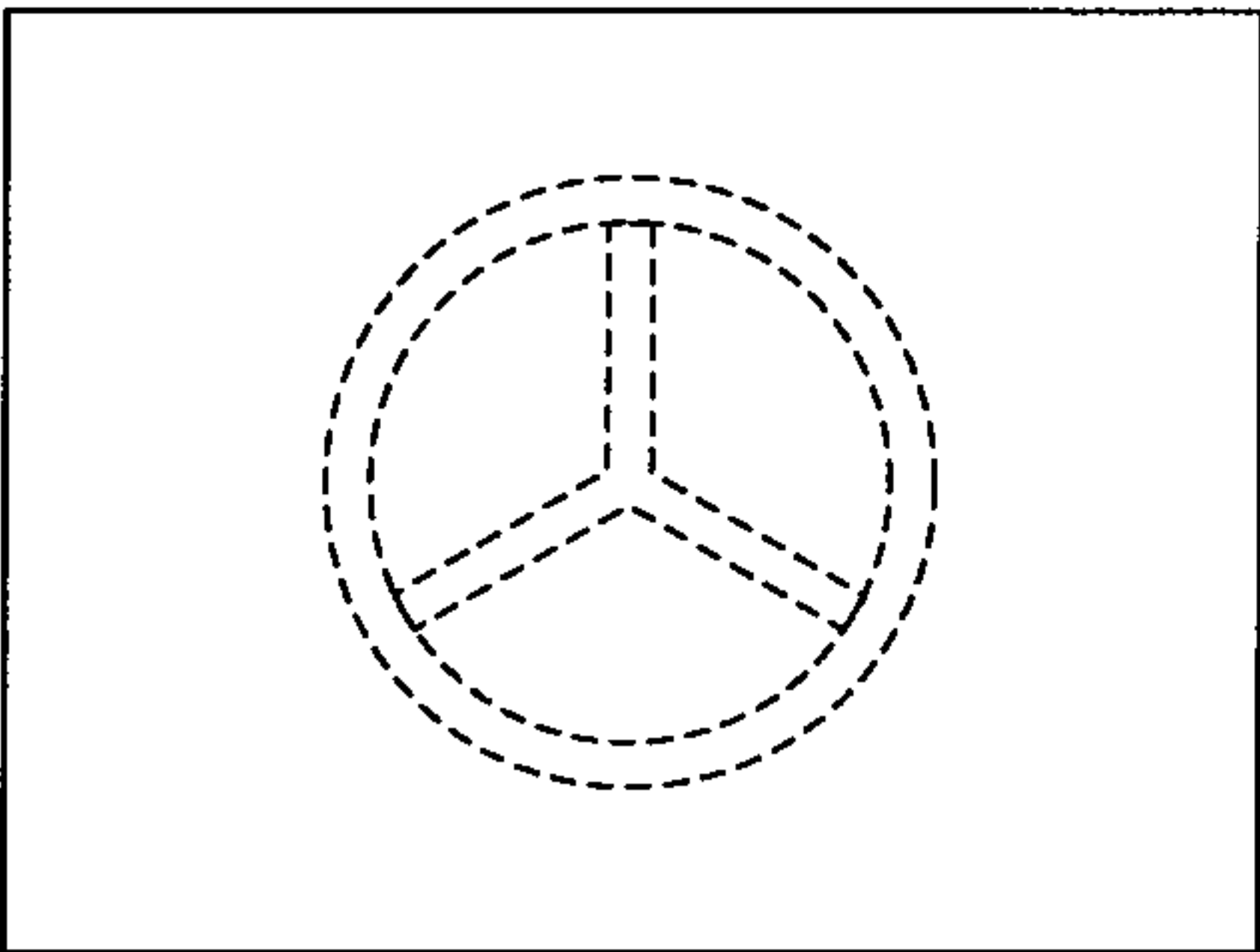

(2) Emergency

This lamp will flash if the oil pressure in the emergency steering pump drops. The lamp notifies the operator that if the steering system also failed at this time, there is no emergency steering system for backup.

- ※ **Immediately pull the machine to a convenient stop and stop the engine.**
- ※ **This machine is equipped with ground driven emergency steering pump. It is normal for the lamp to flash after 5 seconds when the machine is stopped.**

2. SWITCHES

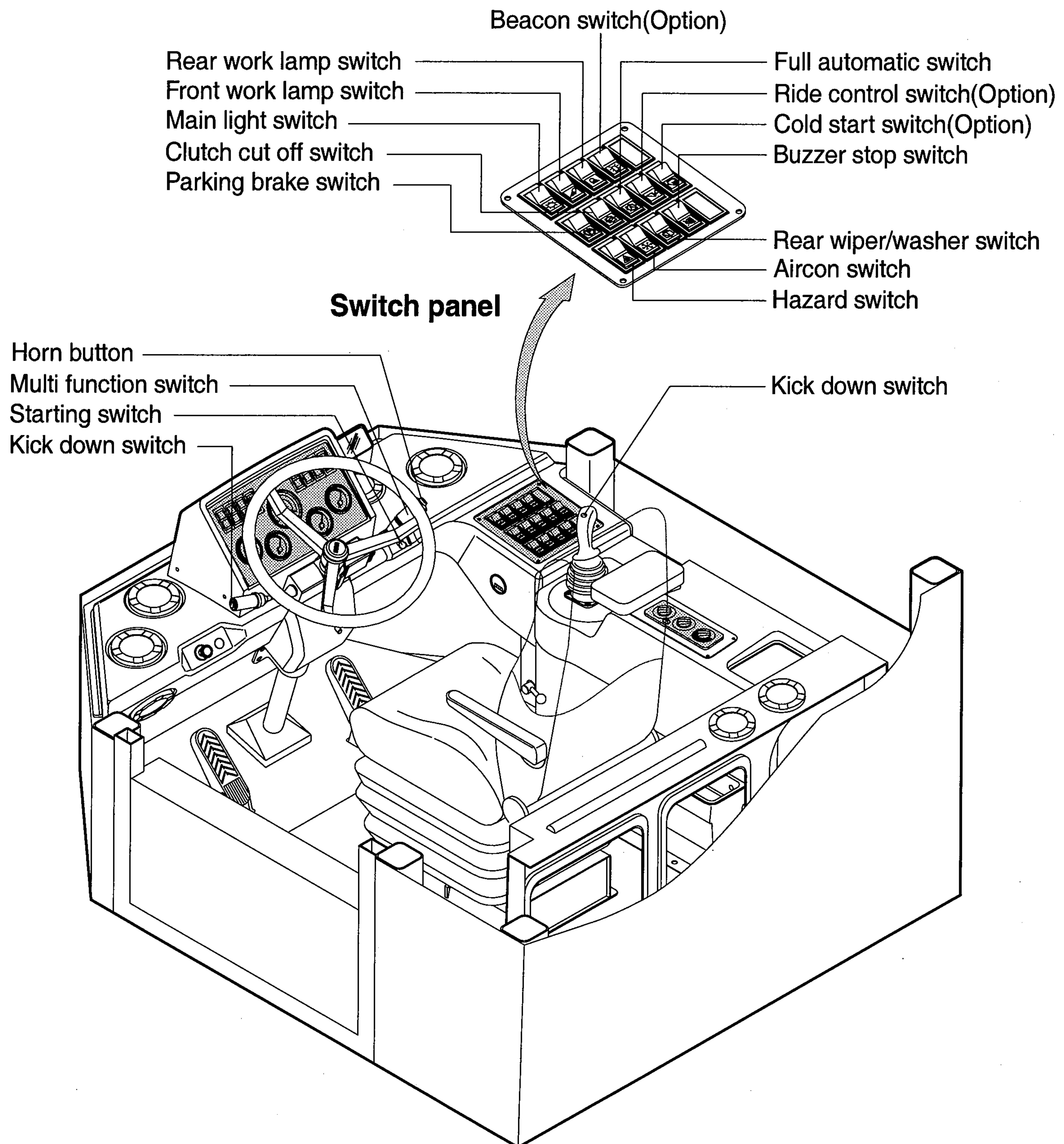

1) STARTING SWITCH

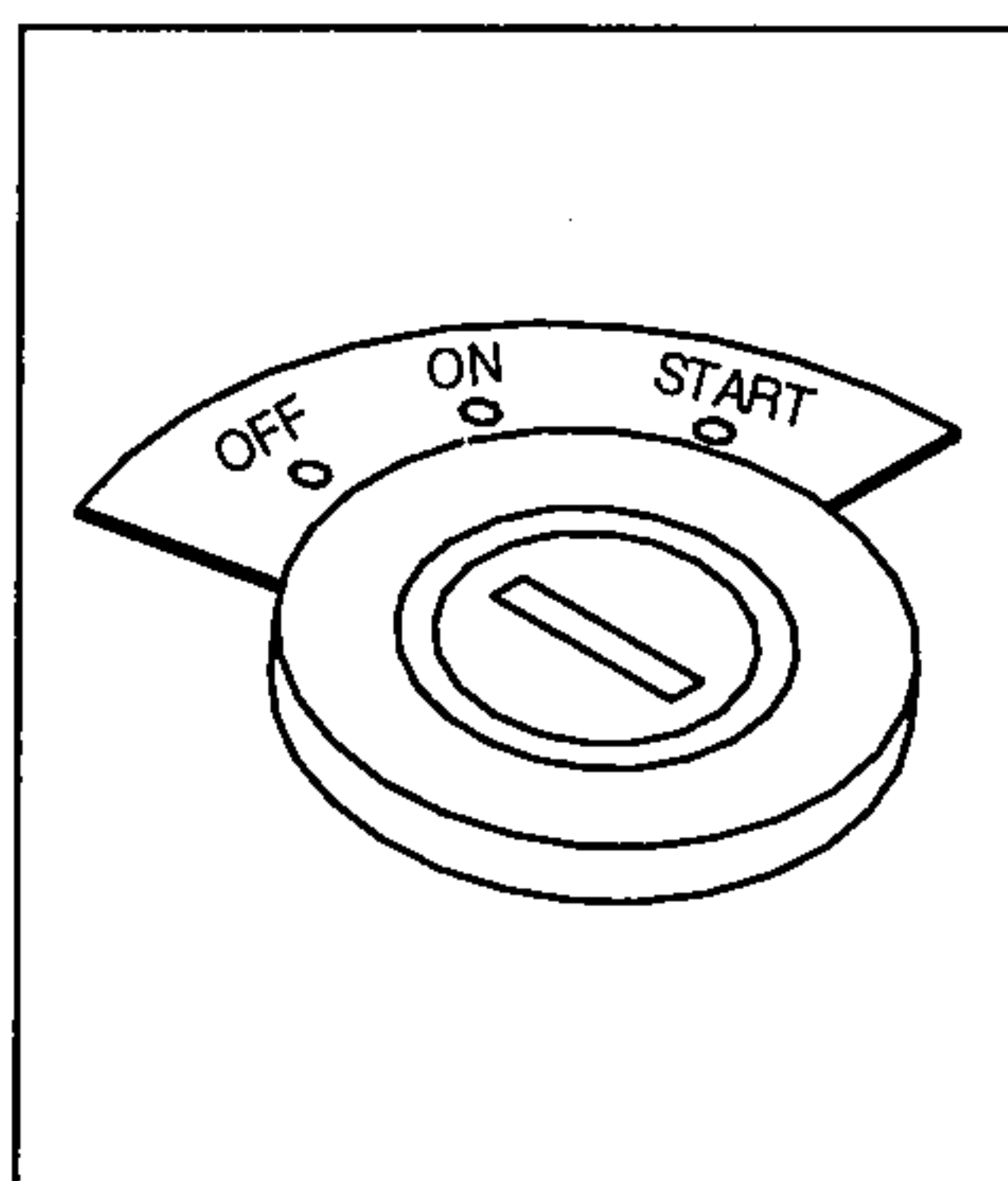

- (1) There are three positions, OFF, ON and START.
- (2) OFF : None of electrical circuits activate.
- (3) ON : All the systems of machine operate.
- (4) START : Use when operating the engine.
Release key immediately after starting.

2) FULL AUTOMATIC SWITCH

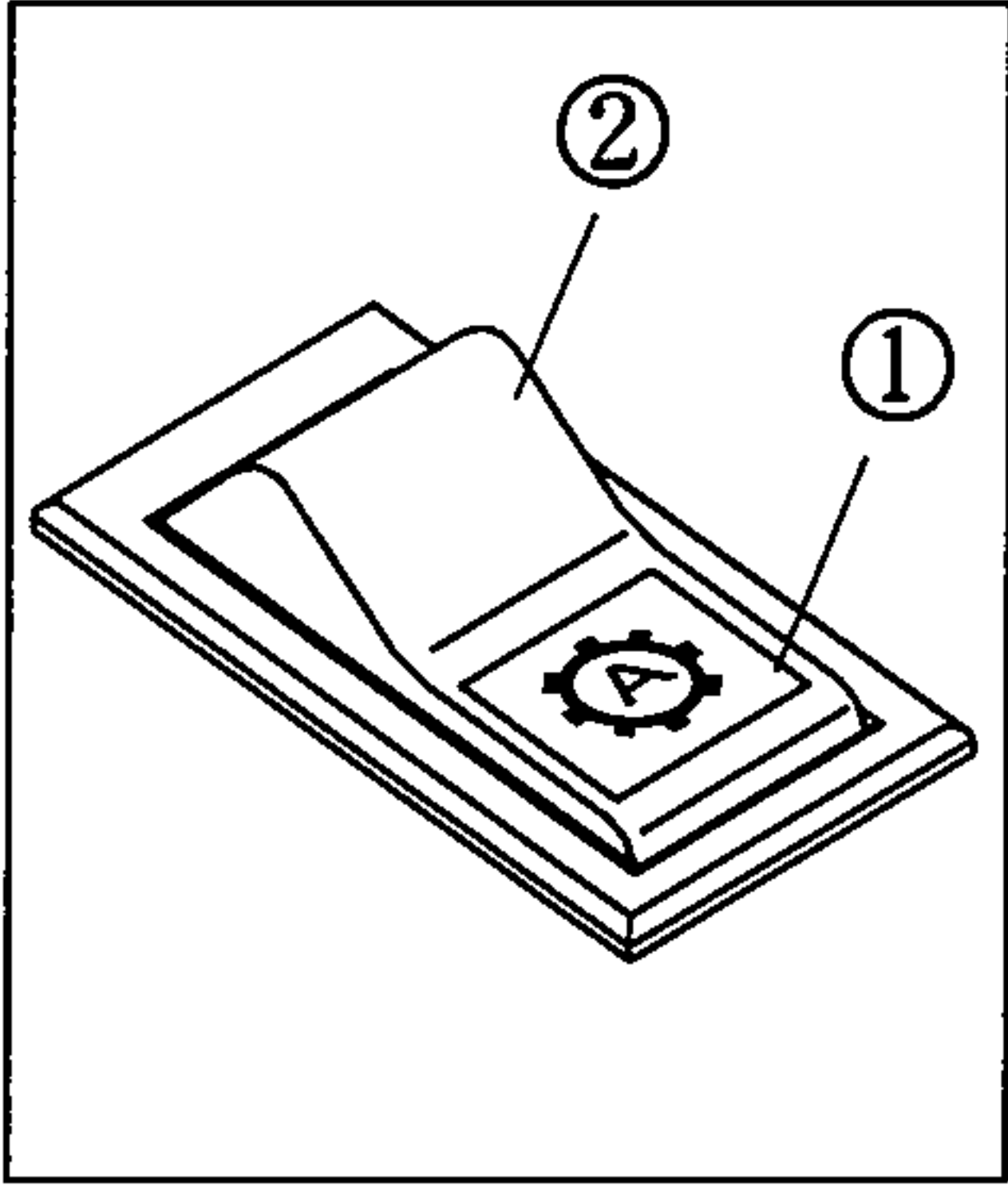

(1) Manual mode(①)

Press the bottom of the switch for the manual mode of the autoshift function. The operator selects the desired speed and the desired direction in the manual mode with the gear selector lever.

(2) Automatic mode(②)

Press the top of the switch for the autoshift function in the automatic mode. Press the top of the switch prior to shifting the transmission into forward or reverse in order to activate the autoshift function.

3) HAZARD SWITCH

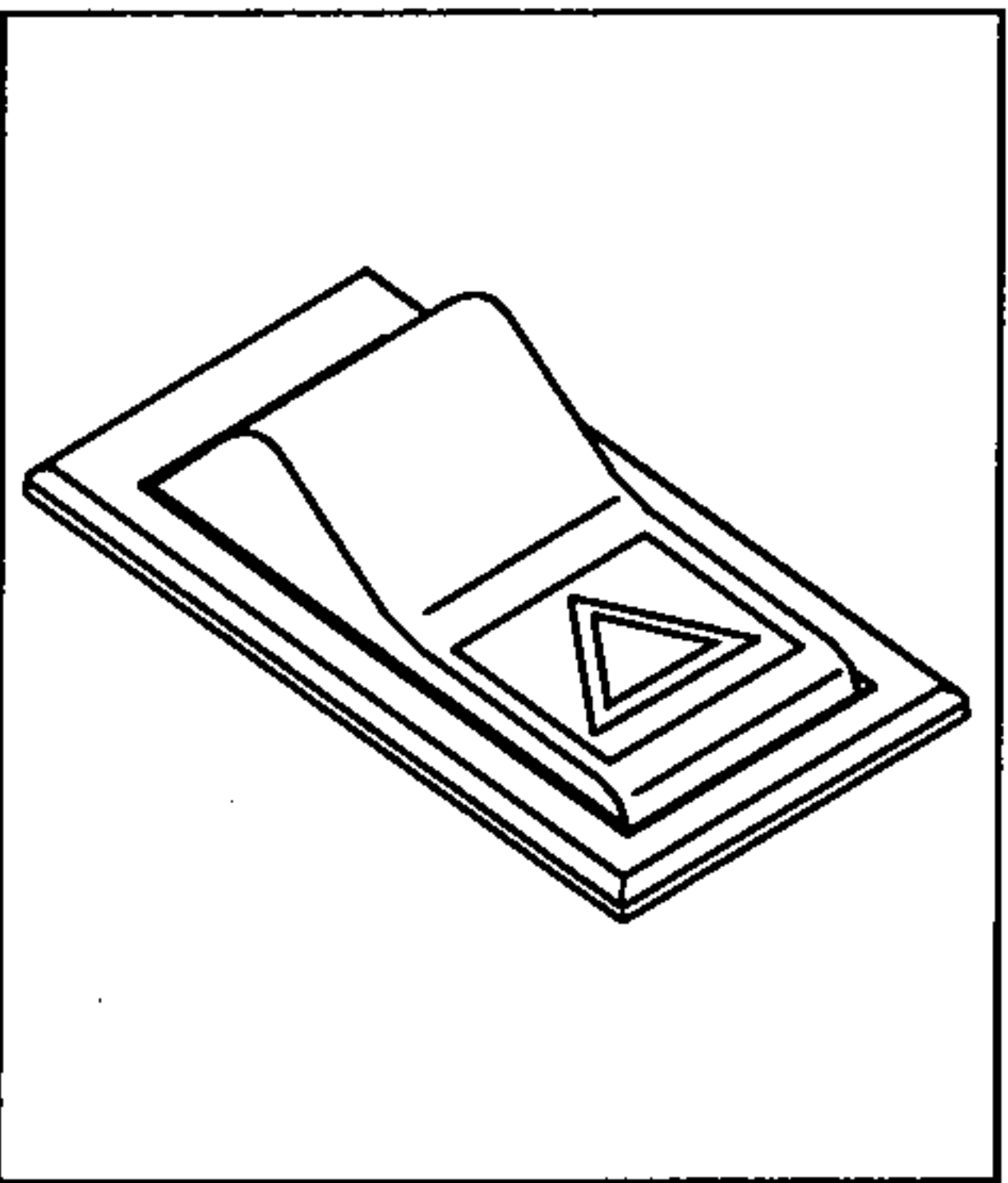

(1) Use for parking, or roading machine.

※ **If the switch is left ON for a long time, the battery may be discharged.**

(2) The below indicator lamp is turned ON when operating this switch.

4) CLUTCH CUT OFF SWITCH

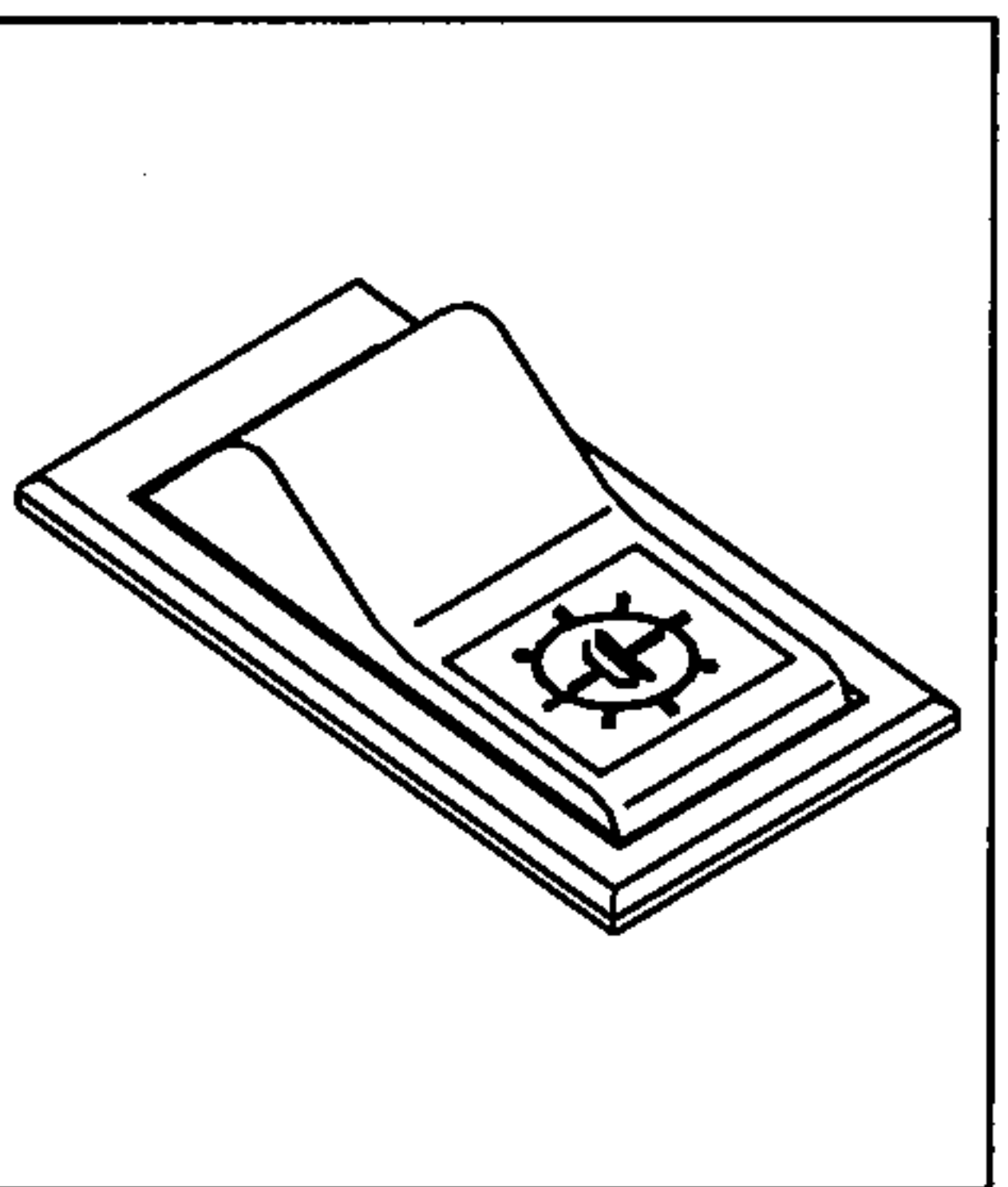

(1) This switch is pressed, it will **cut off** the clutch when brake operates.

※ **Be careful not to use this switch when driving on a slope.**

(2) The below indicator lamp is turned ON when operating this switch.

5) PARKING BRAKE SWITCH

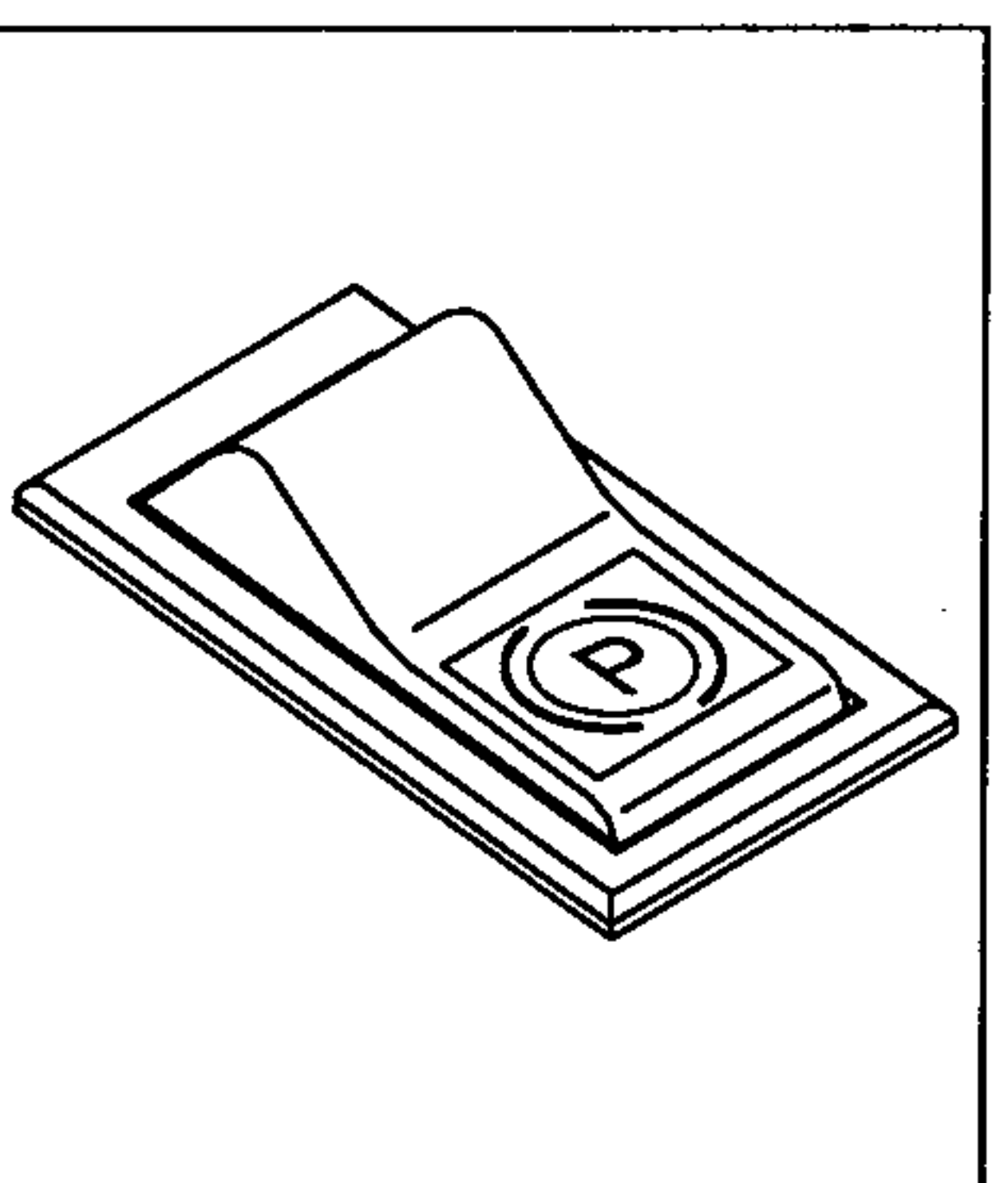

(1) This switch is pressed, the parking brake will start to operate and the gauge panel warning lamp will comes ON.

※ **When operating the gear selector lever, be sure to release the parking brake. If the machine is operated with the parking brake engaged, the brake will overheat and may cause the brake system to go out of order.**

(2) The below indicator lamp is turned ON when operating this switch.

6) MAIN LIGHT SWITCH

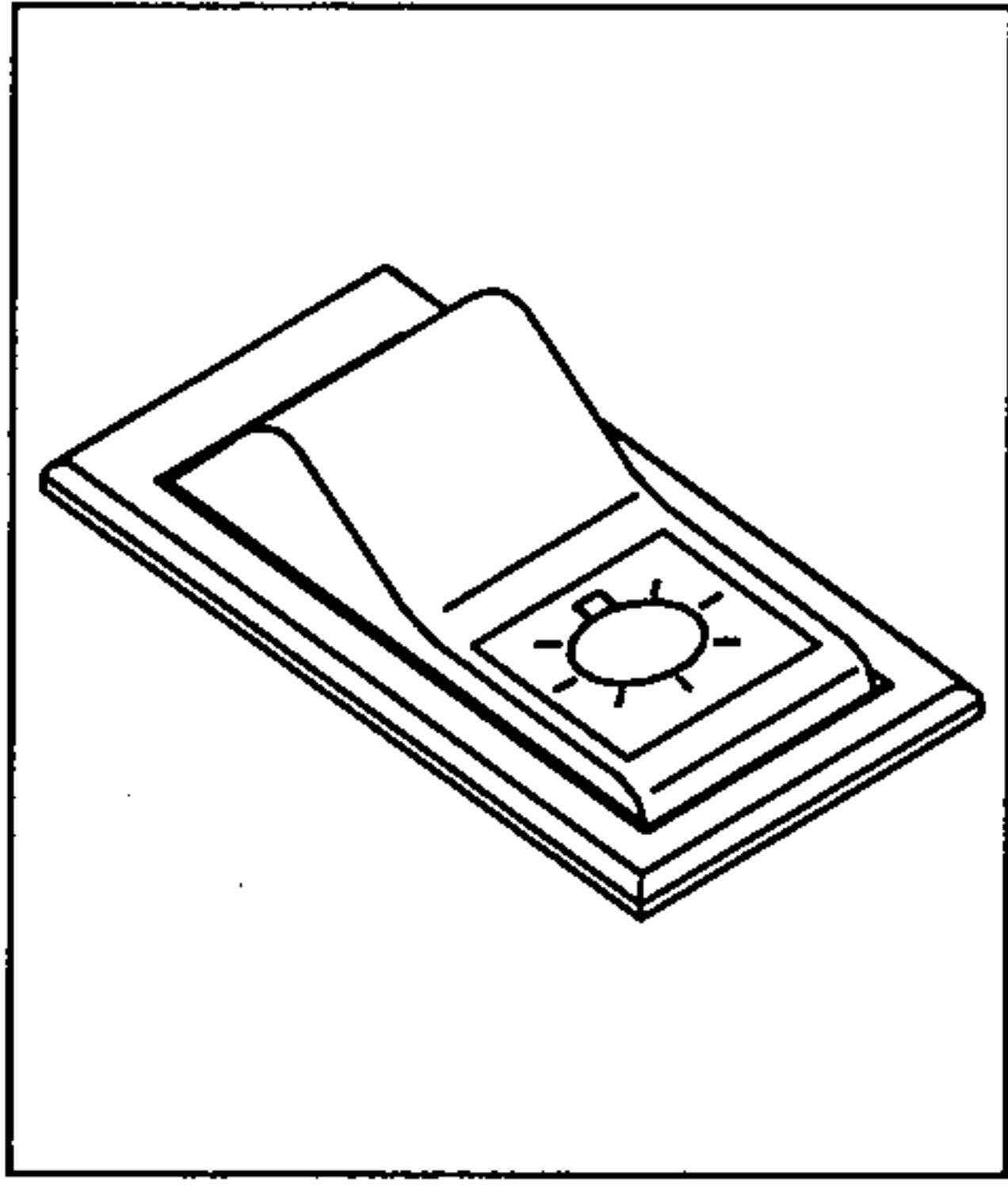

- (1) This switch use to operates the clearance lamp and head light by two step.
 - First step : Clearance lamp and cluster illumination lamp comes ON. Also, the below indicator lamp comes ON.
 - Second step : Head light comes ON.

7) FRONT WORK LAMP SWITCH

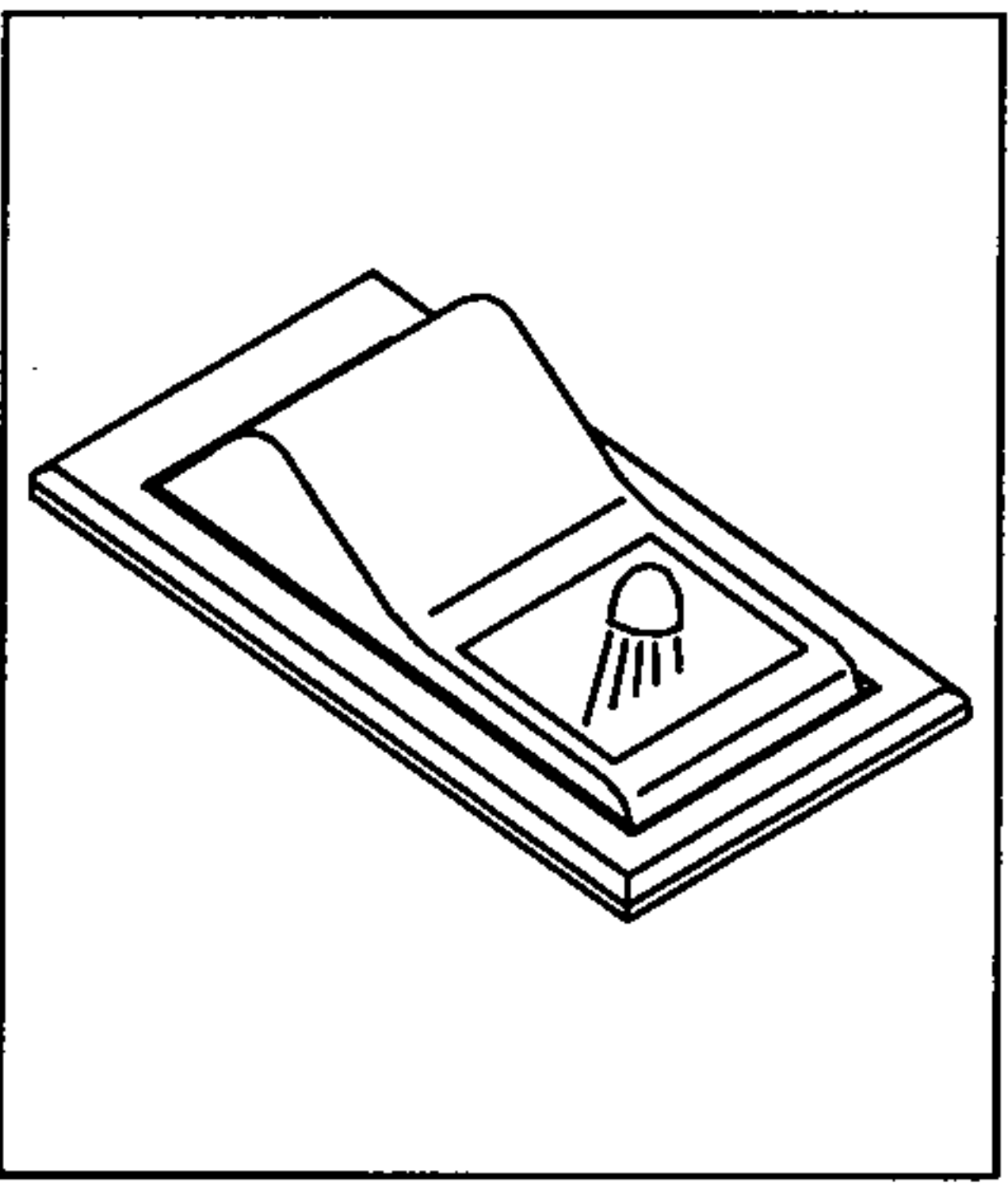

- (1) This switch turns ON the working lamps located on the front of the cab.
- (2) The below indicator lamp is turned ON when operating this switch.

8) REAR WORK LAMP SWITCH

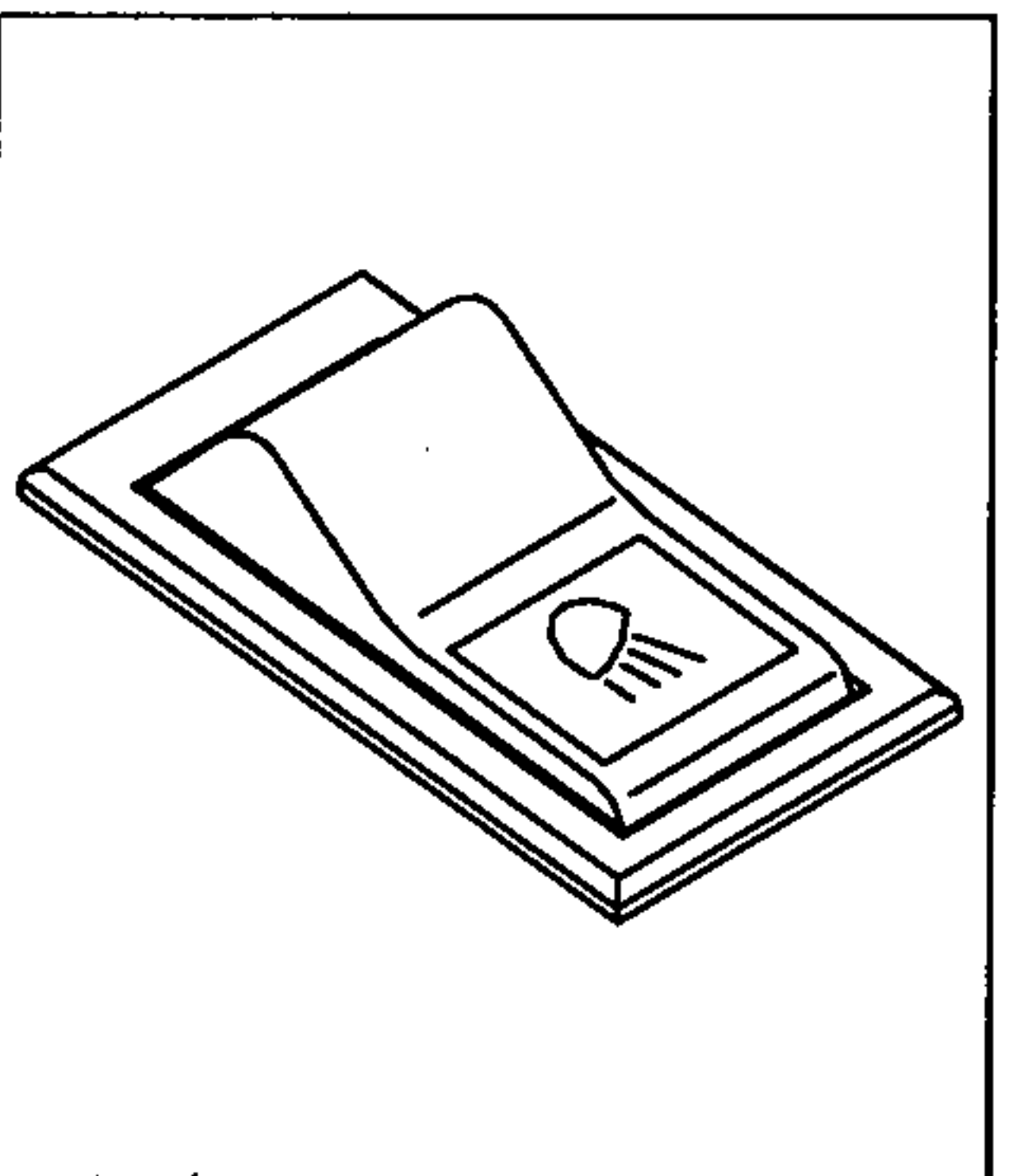

- (1) This switch turns ON the working lamps located on the rear of the cab.
- (2) The below indicator lamp is turned ON when operating this switch.

9) AIR CONDITIONER SWITCH

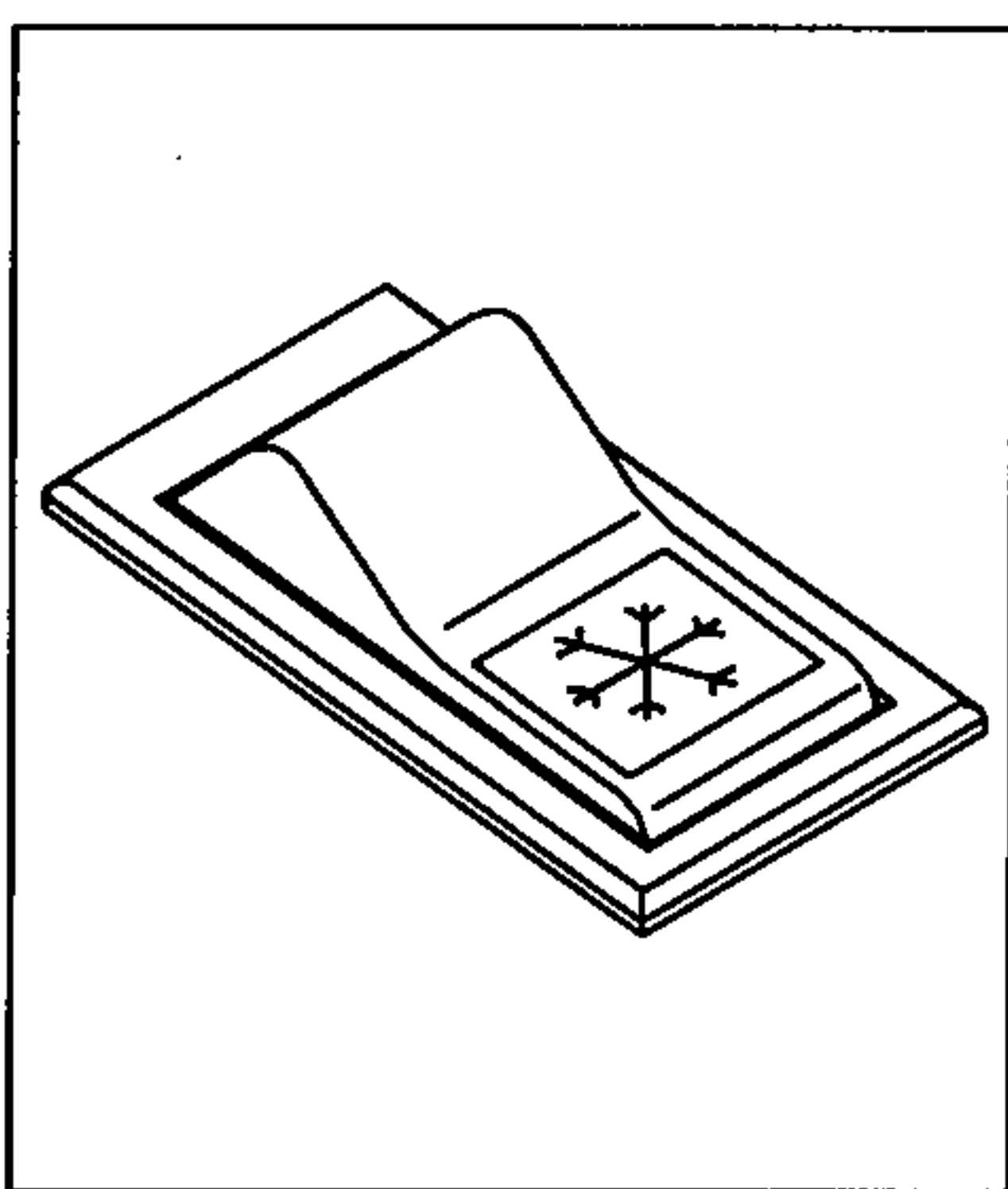

- (1) This switch use to operates the air conditioner.
- (2) Refer to the air conditioner and heater for detail operation.
- (3) The below indicator lamp is turned ON when operating this switch.

10) REAR WIPER AND WASHER SWITCH

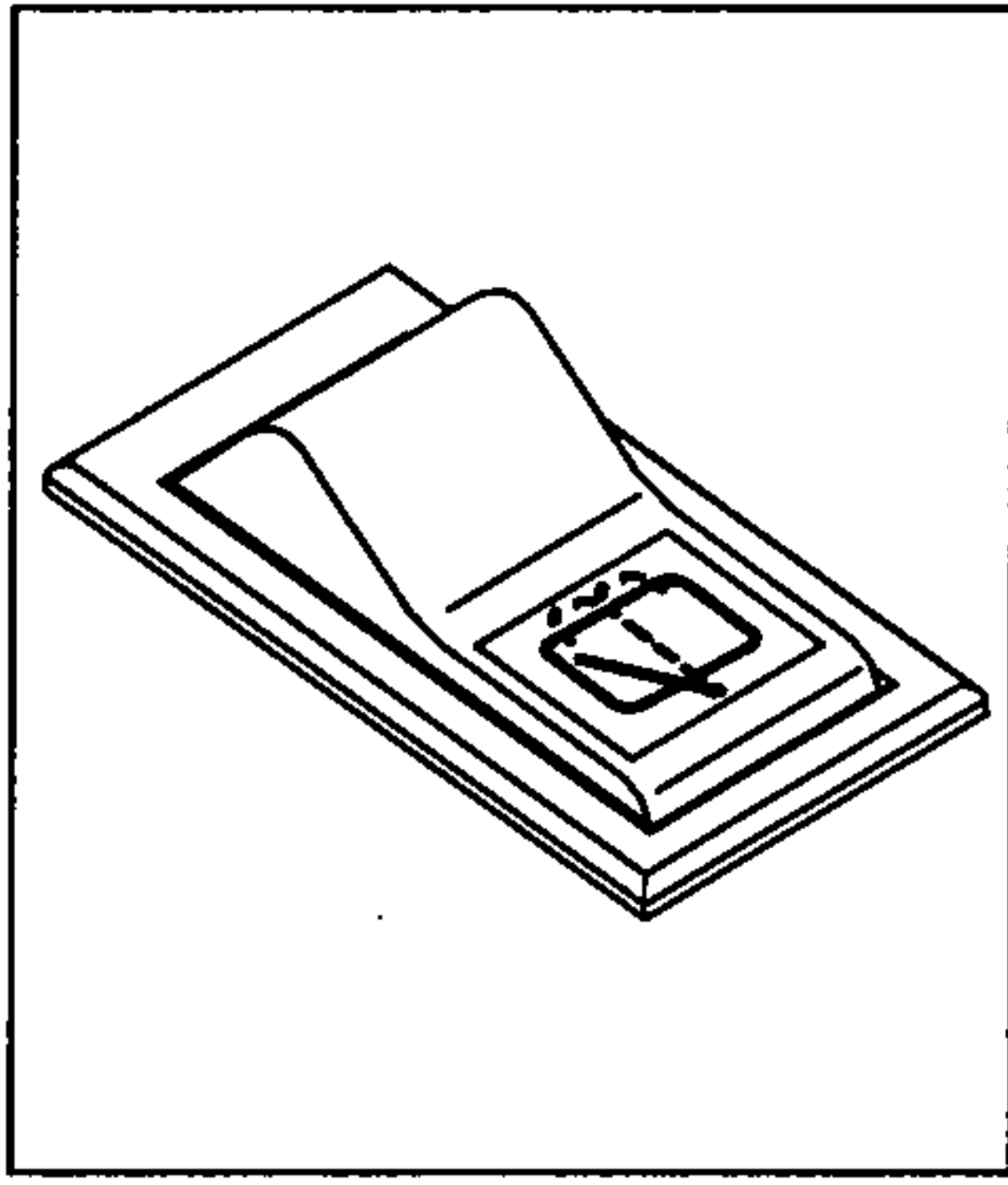

- (1) The switch use to operates the rear wiper and washer by two step.
 - First step : The rear wiper operates.
 - Second step : The washer liquid is sprayed and the rear wiper is operated only while pressing. If release the switch, return to the first step position.

11) BUZZER STOP SWITCH

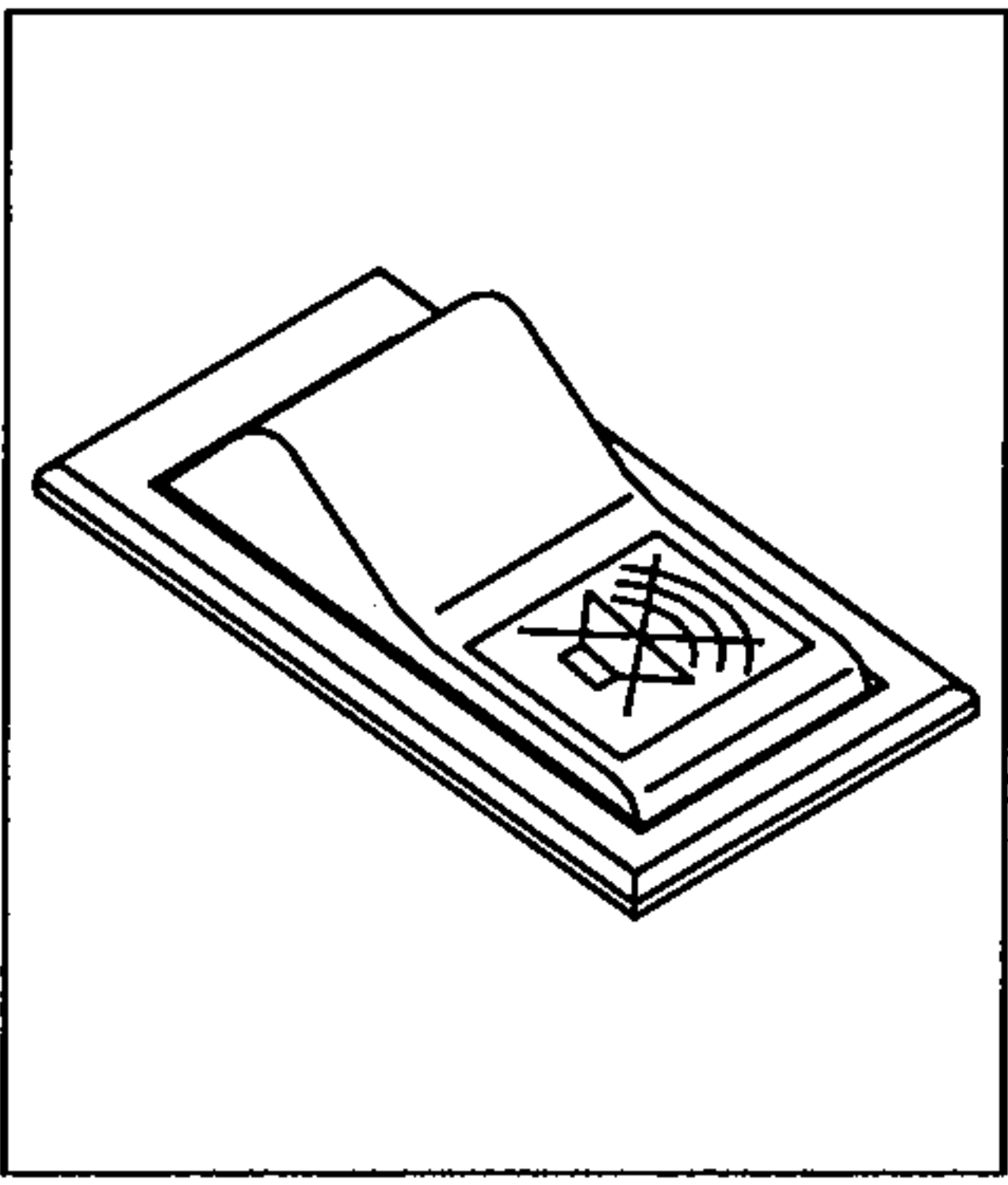

- (1) The red lamp on the cluster lights ON and the buzzer sounds when the machine has a problem.
In this case, if the switch is pressed, the buzzer will be stopped. Be sure to check machine for problems.
- (2) Wait until the lamp is turned OFF, if the red lamp lights ON after the buzzer stopped.
If not, stop engine and check the system which the lamp is ON.

12) CAB LAMP SWITCH

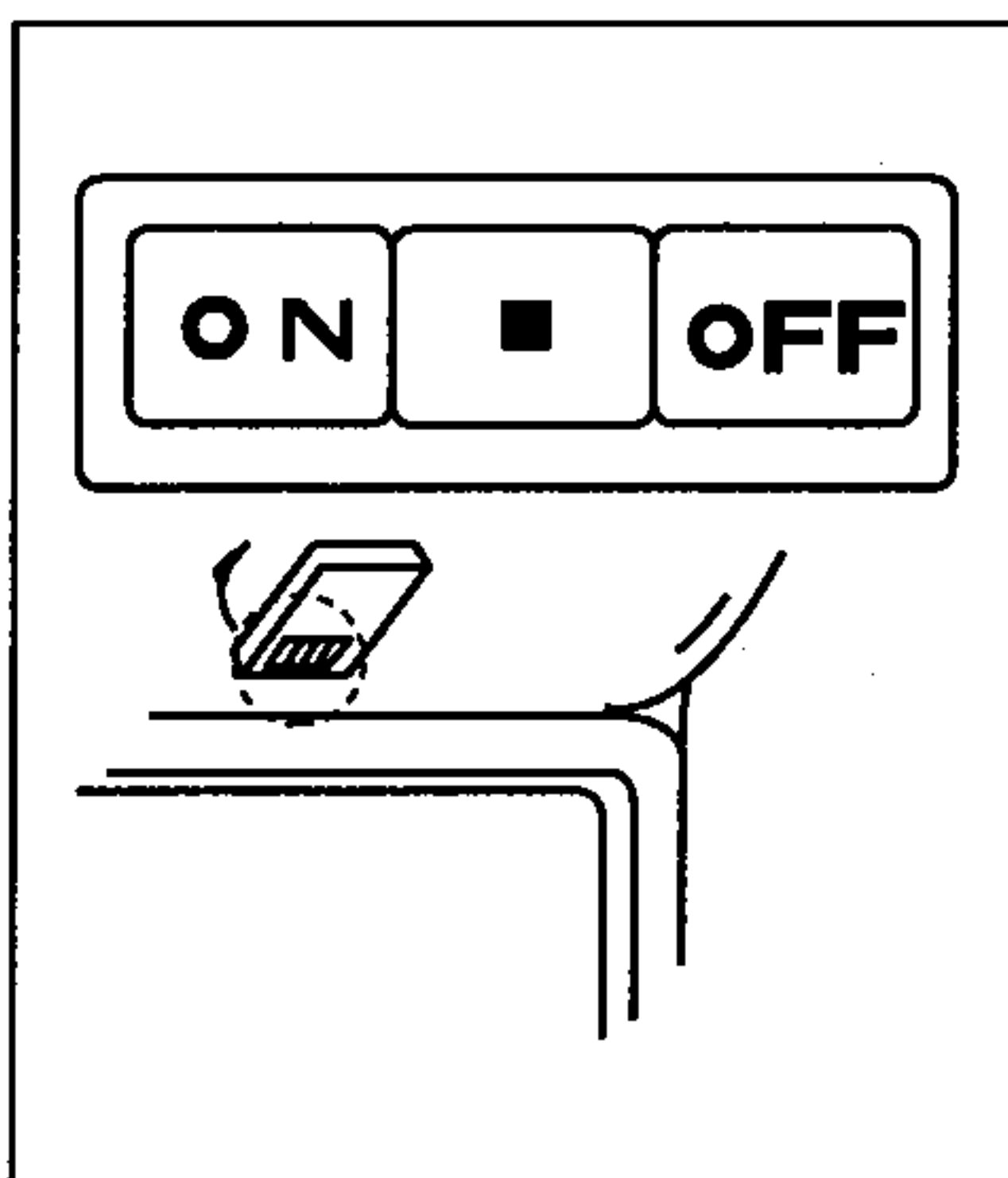

- (1) This switch turns ON the cab room lamp.

13) KICK DOWN SWITCH

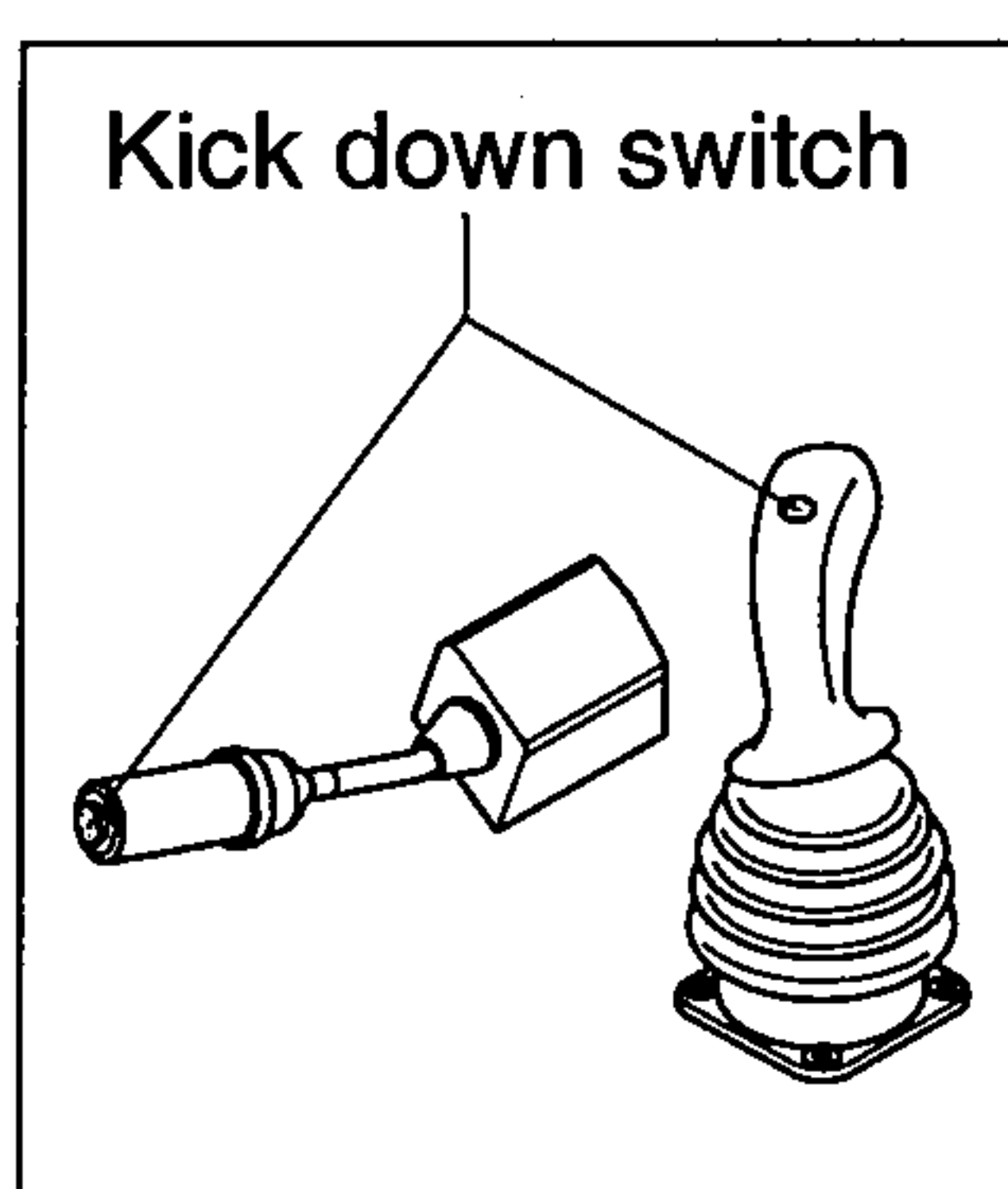

- (1) The kick-down switch into first gear is not allowed. Press the switch and release the switch. The transmission downshifts one gear speed, provided that an engine overspeed would not occur.

14) MULTI FUNCTION SWITCH

(1) Front wiper and washer switch

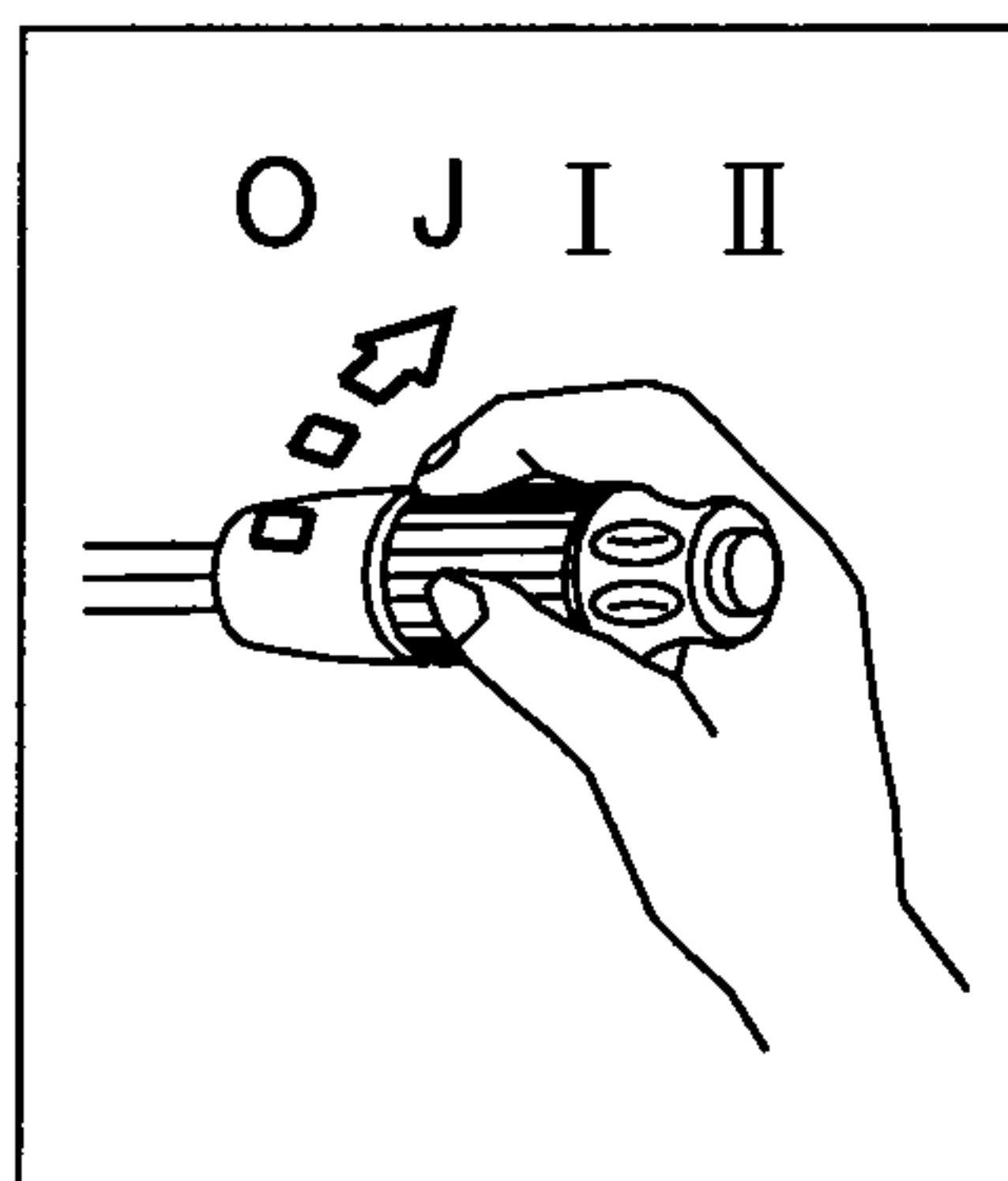

- ① When the switch is in J position, the wiper moves intermittently.
 - ② When placed in I or II position, the wiper moves continuously.
 - ③ If you press a button at the end of the lever, washer liquid will be sprayed and the wiper will be activated 2-3 times.
- ※ **Check the quantity of washer liquid in the tank. If the level of the washer liquid is LOW, add the washer liquid(In cold, winter days) or water. The capacity of the tank is 1 liter.**

(2) Dimmer switch

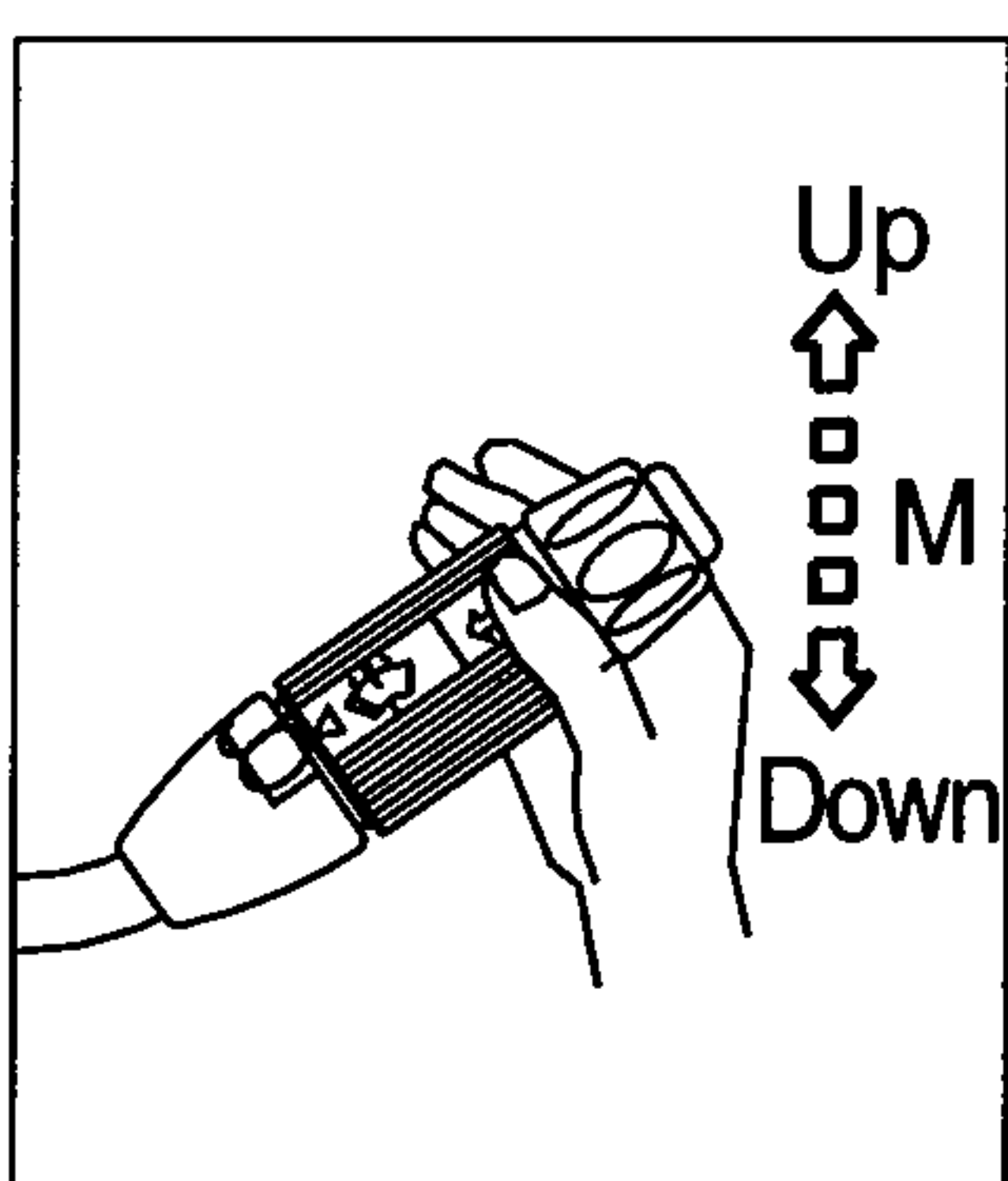

- ① This switch is used to turn the head lights direction.
- ② Switch positions
 - Up : To flash for passing
 - Middle : Head lights low beam ON
 - Down : Head lights high beam ON
- ③ If you release the switch when it's in up position, the switch will return to middle.

(3) Turning switch

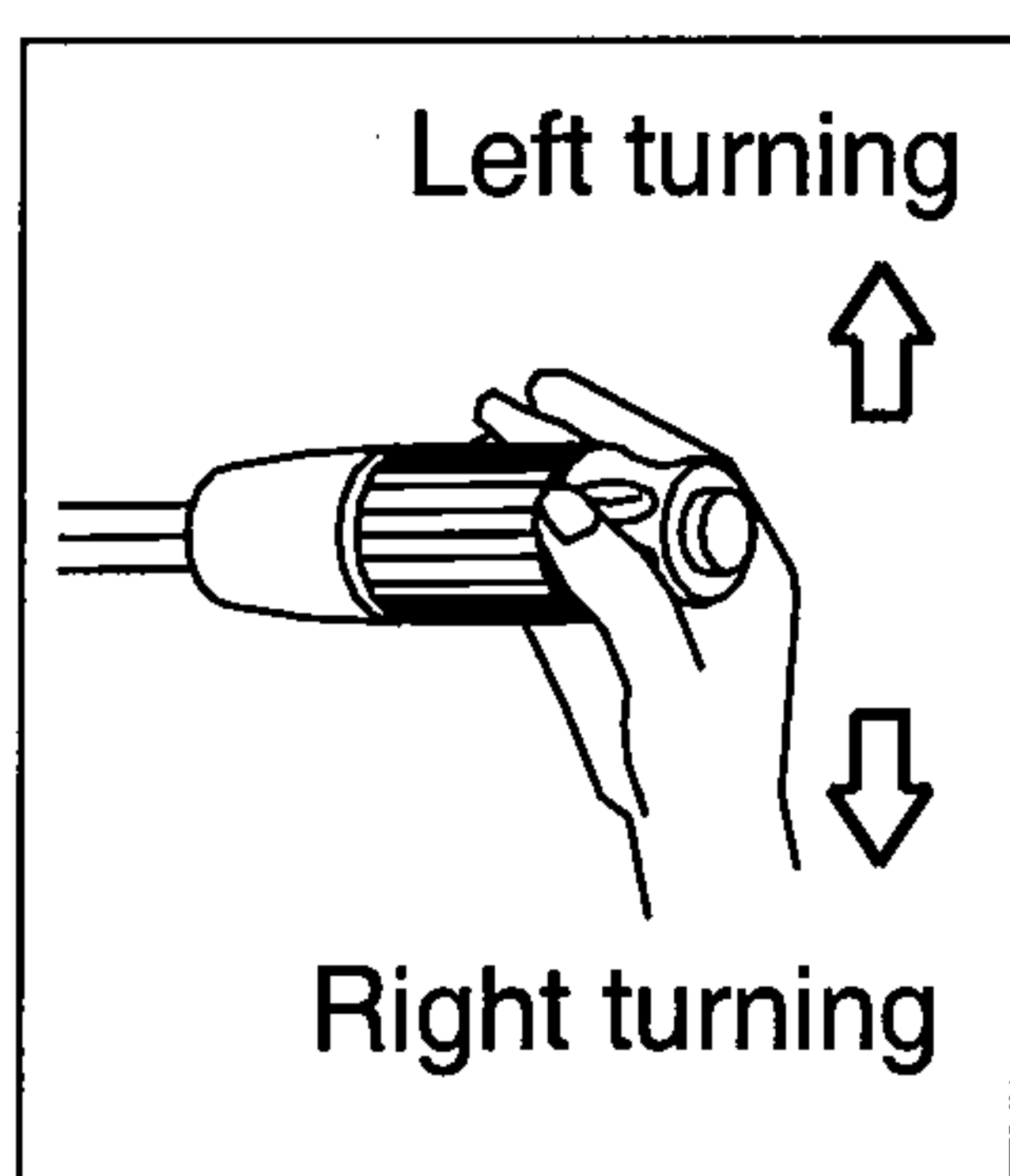

- ① This switch is used to warn or signal the turning direction of the machine to other vehicles or equipment.
- ② Push the lever up for turning left, pull the lever down for turning right.

15) HORN BUTTON

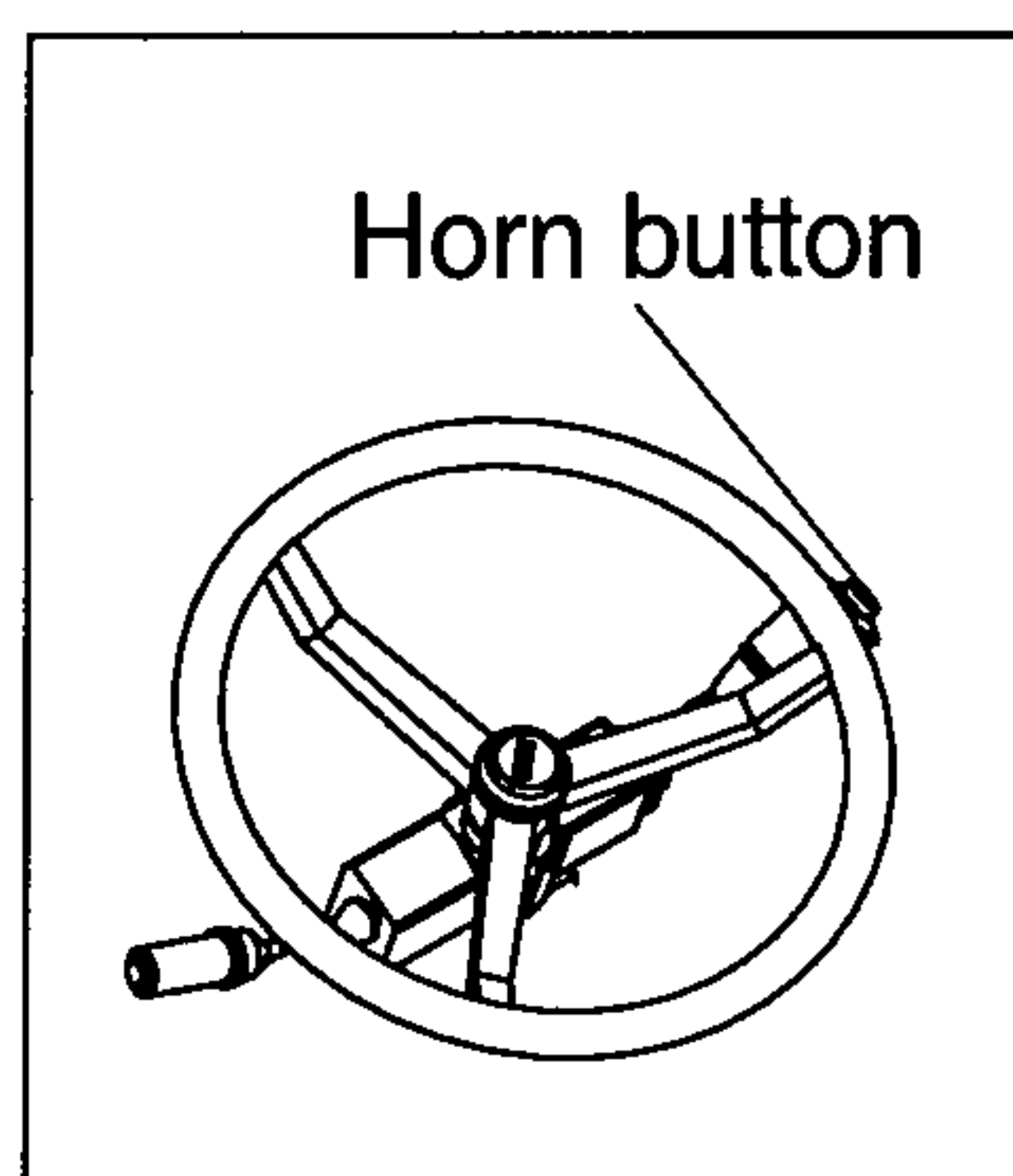

- (1) If you press the button on the top of the multifunction switch, the horn will sound.

16) BEACON SWITCH(Option)

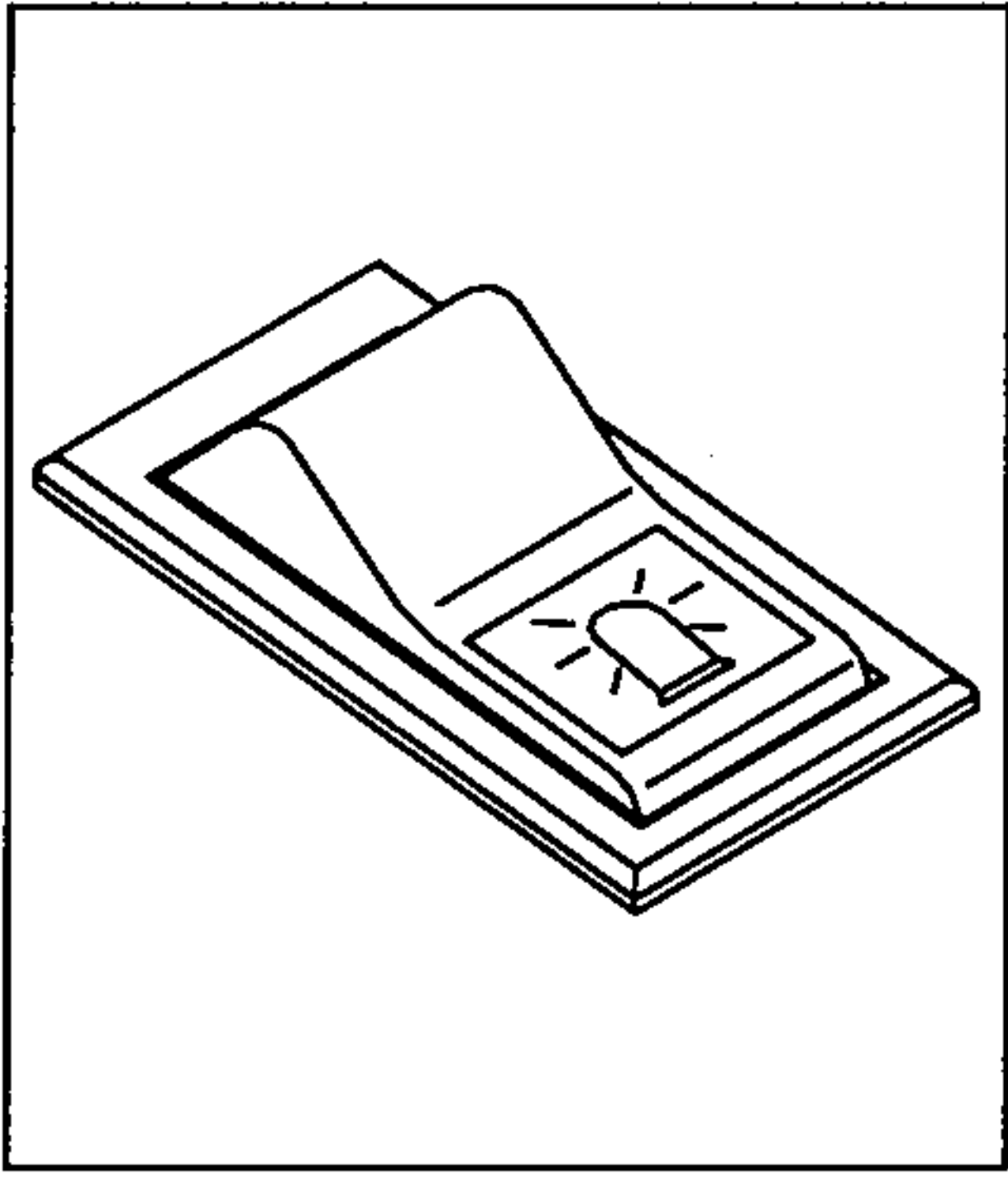

- (1) This switch turns ON the rotary light on the cab.
- (2) The below indicator lamp is turned ON when operating this switch.

17) RIDE CONTROL SWITCH(Option)

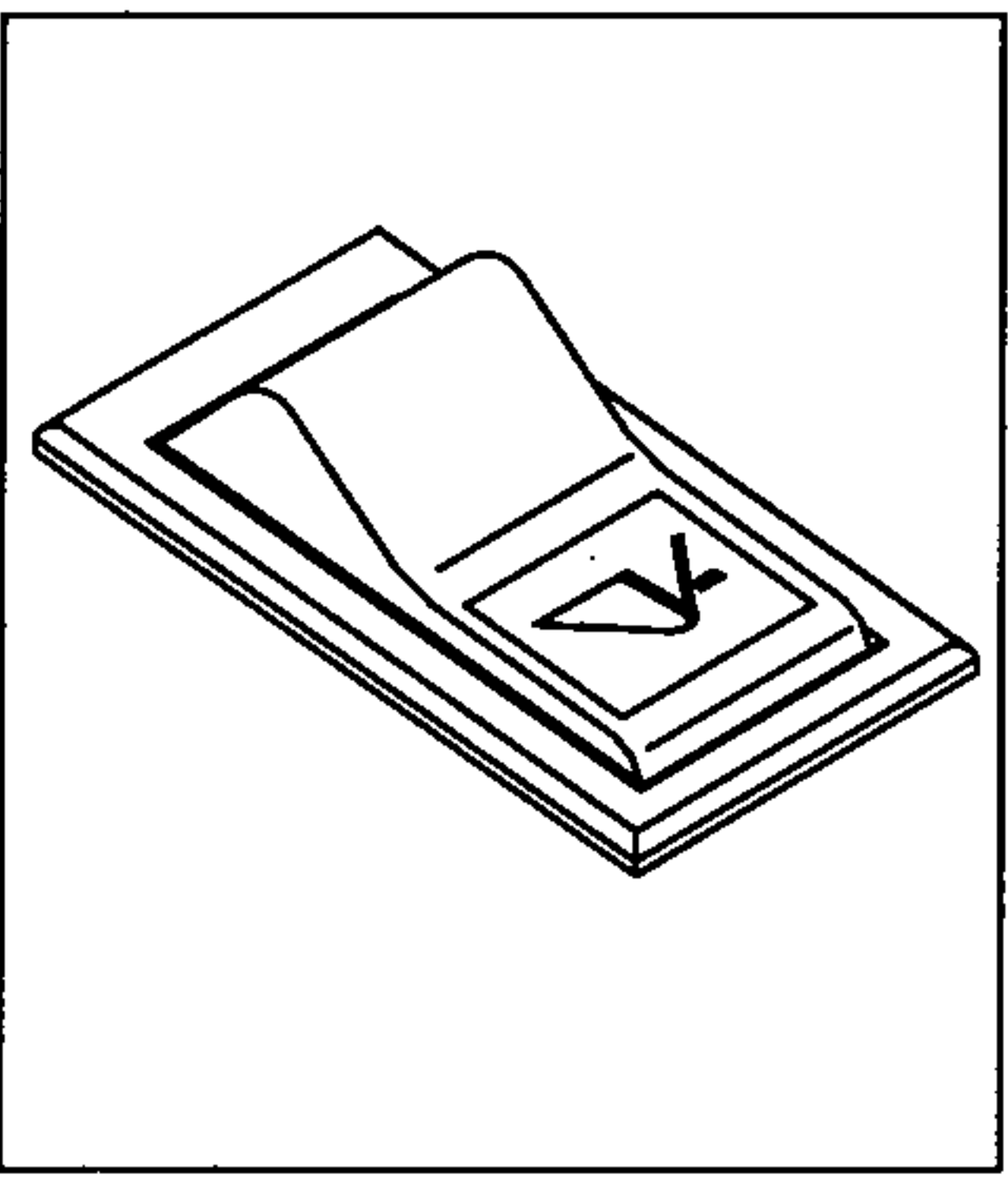

- (1) This switch is pressed, the ride control system will start to operate. The ride control system significantly reduce pitching and roping without slowing down the travel speed.
- (2) The below indicator lamp is turned ON when operating this switch.

18) COLD START SWITCH(Option)

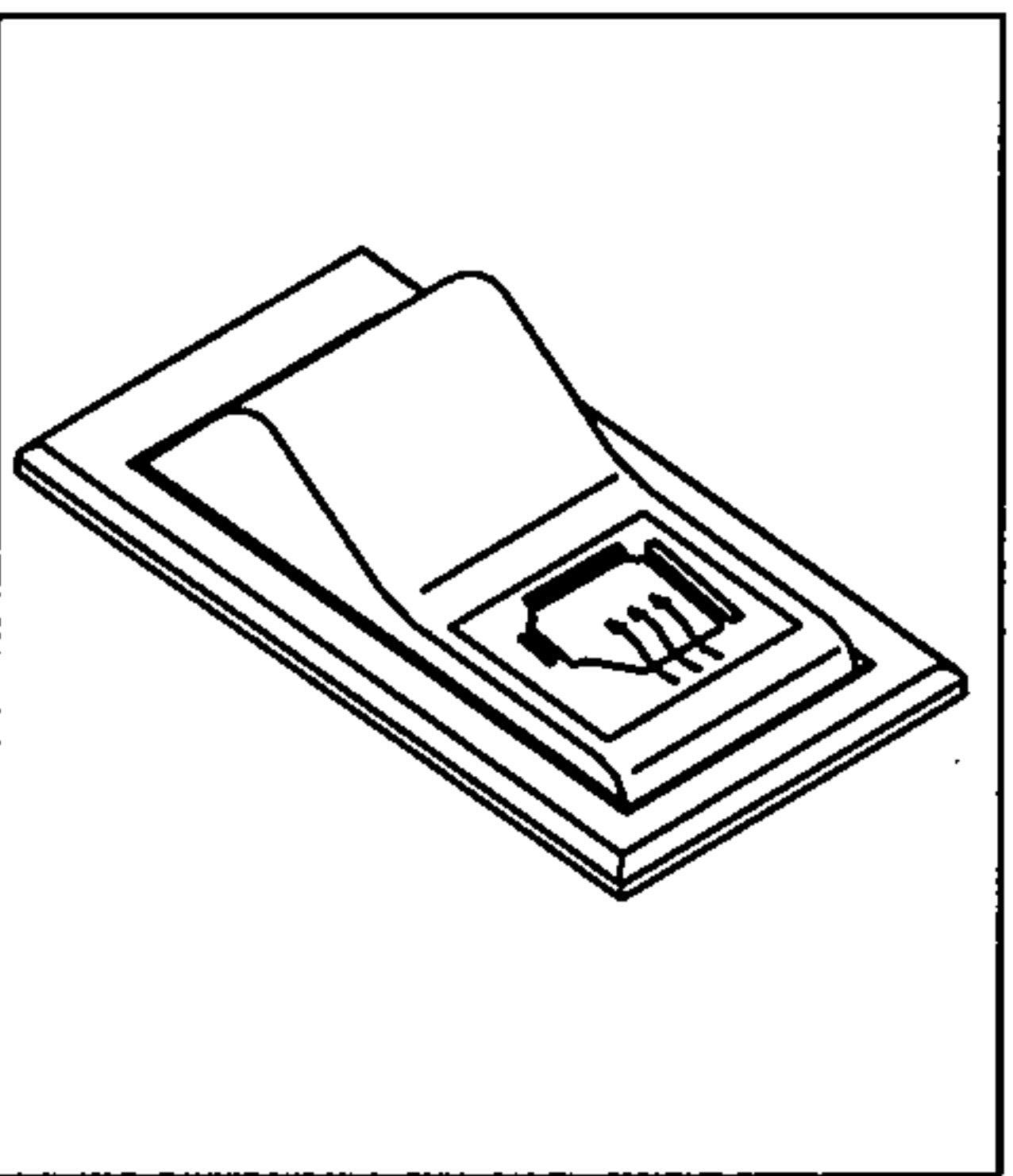

- (1) This switch is used for starting the engine in cold weather. If pressed, starting aid fluid is injected for easier engine starting.
- (2) The below indicator lamp is turned ON when operating this switch.
* **Never hold the push button switch in for more than 5 seconds, as this can damage the electric valve solenoid.**