

GROUP 3 FUEL WARMER SYSTEM

1. SPECIFICATION

- 1) Operating voltage : $24 \pm 4V$
- 2) Power : $350 \pm 50W$
- 3) Current : 15A

2. OPERATION

- 1) The current of fuel warmer system is automatically controlled without thermostat according to fuel temperature.
 - 2) At the first state, the 15A current flows to the fuel warmer and engine may be started in 1~2 minutes.
 - 3) If the fuel starts to flow, ceramic-disk in the fuel warmer heater senses the fuel temperature to reduce the current as low as 1.5A.
- So, fuel is protected from overheating by this mechanism.

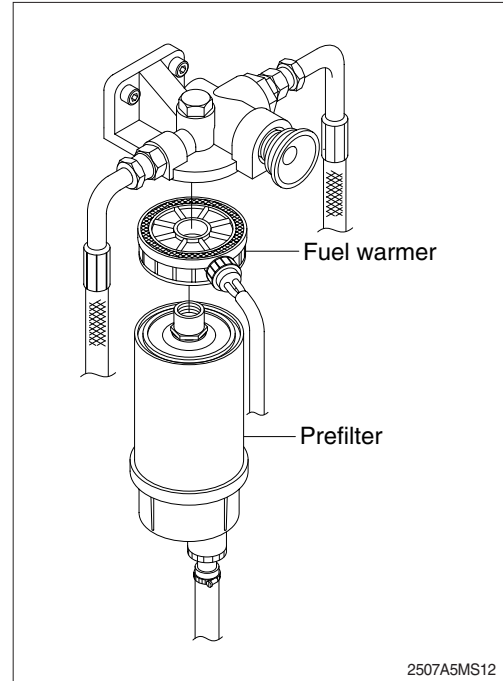

3. ELECTRIC CIRCUIT

