

GROUP 3 MONITORING SYSTEM

1. CLUSTER

1) STRUCTURE

The cluster consists of gauges, lamps and LCD as shown below, to warn the operator in case of abnormal machine operation or conditions for the appropriate operation and inspection.

- Gauges : Indicate operating status of the machine.
 - Warning lamps : Indicate abnormality of the machine.
 - Pilot lamps : Indicate operating status of the machine.
 - LCD : Indicates selected the driving speed and direction.
- ※ The cluster installed on this machine does not entirely guarantee the condition of the machine. Daily inspection should be performed according to chapter 6, MAINTENANCE in operator's manual.
- ※ When the cluster provides a warning immediately check the problem, and perform the required action.

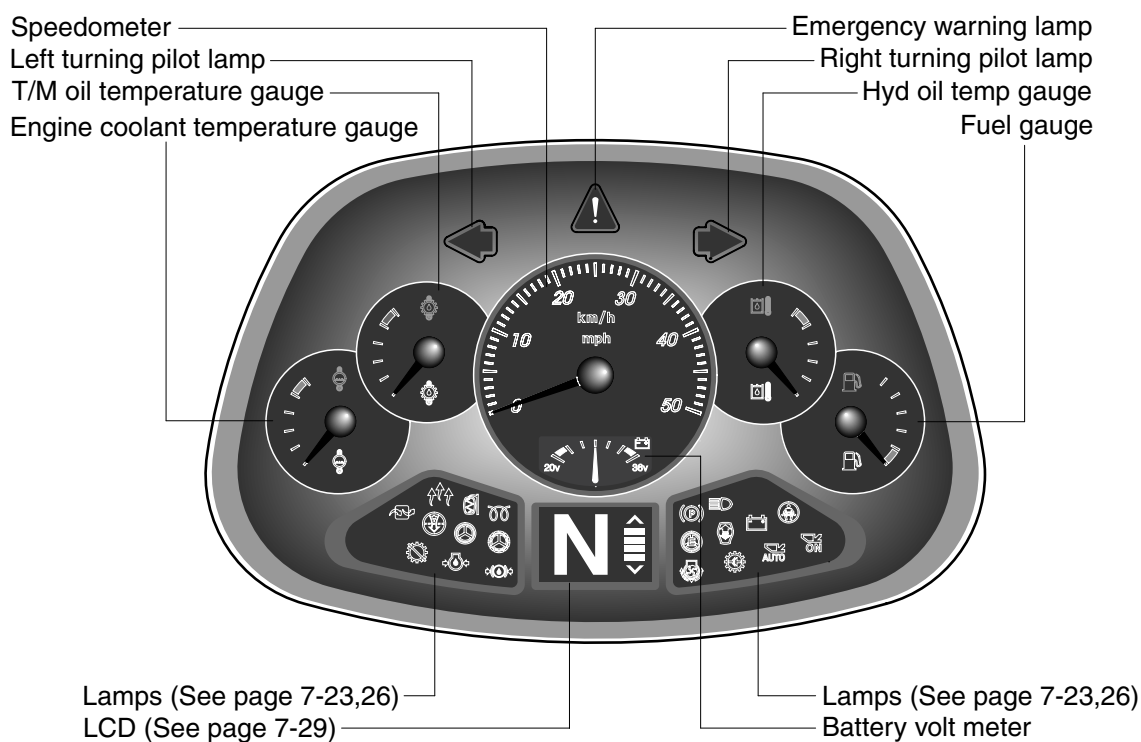

75797EL55

2) GAUGE

(1) Speedometer

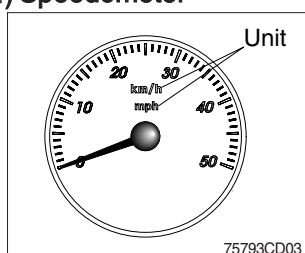

- ① The speedometer displays the speed of machine in mph and km/h.
- ※ The unit (km/h or mph) can be set by the display set up menu of the monitor and selected unit is displayed. Refer to page 7-42.

(2) Fuel gauge

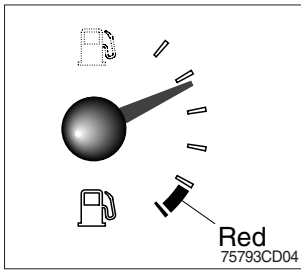

- ① This gauge indicates the amount of fuel in the fuel tank.
 - ② Fill the fuel when the indicator moves red range or  lamp blinks in red, refuel as soon as possible to avoid running out of fuel.
- ※ If the gauge indicates below red range even though the machine is on the normal condition, check the electric device as that can be caused by the poor connection of electricity or sensor.

(3) Engine coolant temperature gauge

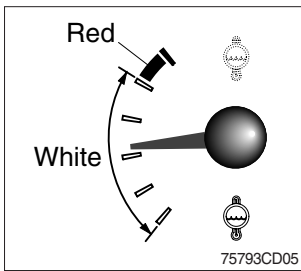

- ① This gauge indicates the temperature of coolant.
 - White range : 40~104°C (104~219°F)
 - Red range : Above 104°C (219°F)
- ② If the indicator is in the red range or  lamp blinks in red, turn OFF the engine and check the radiator and engine.

(4) Transmission oil temperature gauge

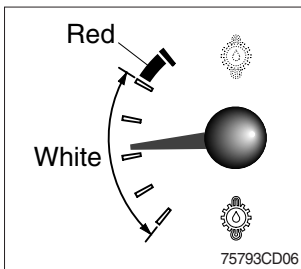

- ① This gauge indicates the temperature of transmission oil.
 - White range : 40~107°C (104~225°F)
 - Red range : Above 107°C (225°F)
- ② If the indicator is in the red range or  lamp blinks in red, it means the transmission is overheated. Be careful that the indicator does not move into the red range.

(5) Hyd oil temperature gauge

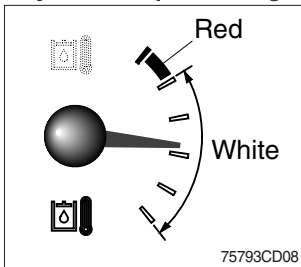

- ① This gauge indicates the temperature of hydraulic oil.
 - White range : 40~105°C (104~221°F)
 - Red range : Above 105°C (221°F)
- ② If the indicator is in the red range or  lamp blinks in red, reduce the load on the system.
- ③ If the gauge stays in the red range, stop the machine and check the cause of the problem.

(6) Battery volt meter

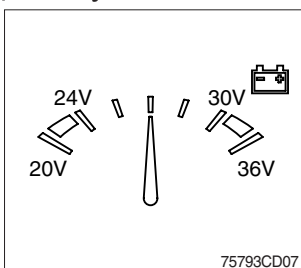

- ① This gauge indicates the voltage in the charging system when the engine is running.
- ② If the indicator is below 24V, it means that the electricity is being discharged. If the indicator is above 30V, an unusually high voltage may damage the alternator. Check the charging system in both cases.

3) WARNING LAMPS

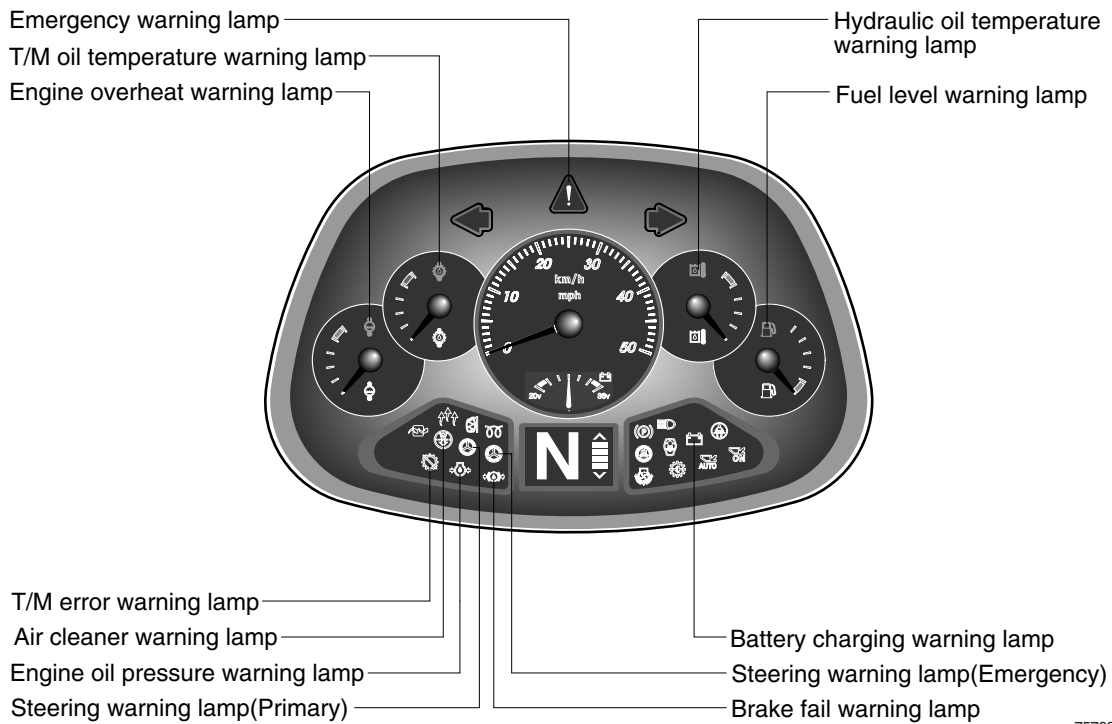

75793CD09

(1) Emergency warning lamp



- ① This warning lamp blinks and the buzzer sounds when communication error occur between monitor and MCU.
- ② When this warning lamp blinks, machine must be checked and service immediately.

(2) Engine overheat warning lamp

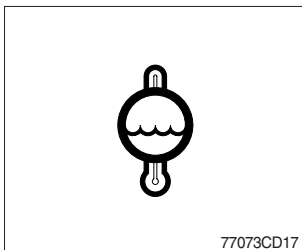

- ① This lamp is turned ON when the temperature of coolant is over the normal temperature 104°C (219°F).
- ② Check the cooling system when the lamp is ON.

(3) Transmission oil temperature warning lamp

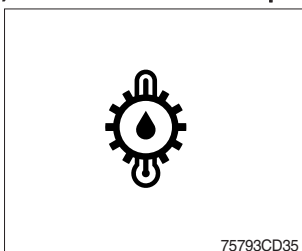

- ① This lamp informs the operator that transmission oil is above the specified temperature.
- ② When this lamp lights up during operation, stop the engine and check the machine.

(4) Hydraulic oil temperature warning lamp

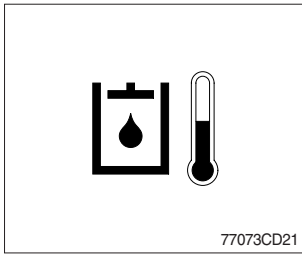

- ① This warning lamp operates and the buzzer sounds when the temperature of hydraulic oil is over 105°C (221°F).
- ② Check the hydraulic oil level when the lamp is turned ON.
- ③ Check for debris between oil cooler and radiator.

(5) Fuel level warning lamp

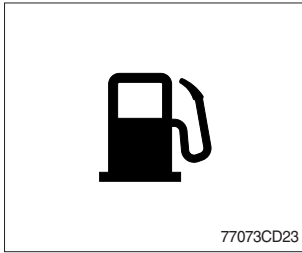

- ① This warning lamp lights ON when the fuel level is low. Refuel the machine as soon as possible.

(6) Transmission error warning lamp

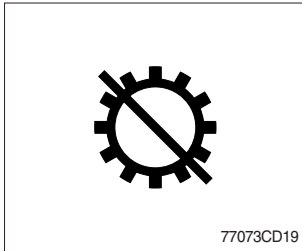

- ① This lamp lights ON and the LCD display show the error codes when an error occurs in the transmission.
 - ② Immediately pull the machine to a convenient stop. Stop the engine. Investigate the cause.
- ※ **Consult a HYUNDAI dealer to investigate the cause.**
 - ※ **Do not operate until the cause has been corrected.**

(7) Air cleaner warning lamp

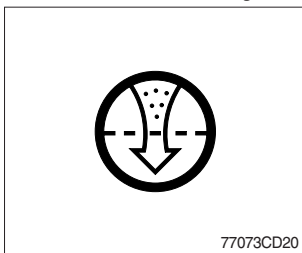

- ① This lamp lights ON when the filter of air cleaner is clogged.
- ② Check the filter and clean or replace it when the lamp is ON.

(8) Engine oil pressure warning lamp

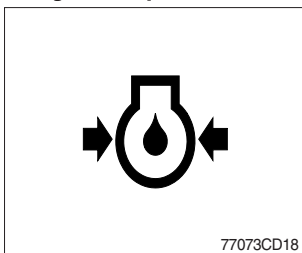

- ① This lamp is comes ON after starting the engine because of the low engine oil pressure.
- ② If the lamp comes ON during engine operation, shut OFF engine immediately. Check engine oil level.

(9) Steering warning lamp

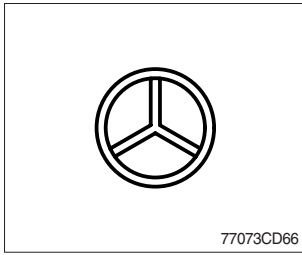

① Primary

This lamp indicates that the primary steering has failed. When the indicator comes on and the action alarm sounds, steer the machine immediately to a convenient location and stop the machine. Stop the engine and investigate the cause.

※ **Do not operate the machine until the cause has been corrected.**

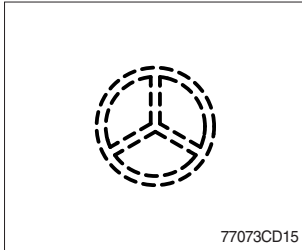

② Emergency

This lamp indicates the emergency steering system is active.

※ **Immediately pull the machine to a convenient stop and stop the engine.**

※ **The emergency steering system can be manually tested. Refer to page 7-47.**

(10) Battery charging warning lamp

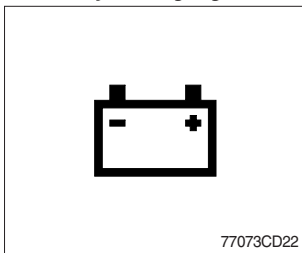

① This lamp is ON when key ON, it is turned OFF after starting the engine.

② Check the battery charging circuit when this lamp comes ON, during engine operation.

(11) Brake fail warning lamp

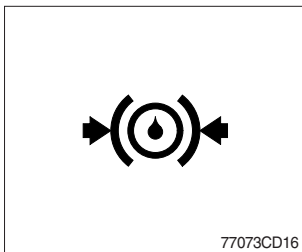

① The lamp lights ON when the oil pressure of service brake drops below the normal range.

② When the lamp is ON, stop the engine and check for its cause.

※ **Do not operate until any problems are corrected.**

4) PILOT LAMPS

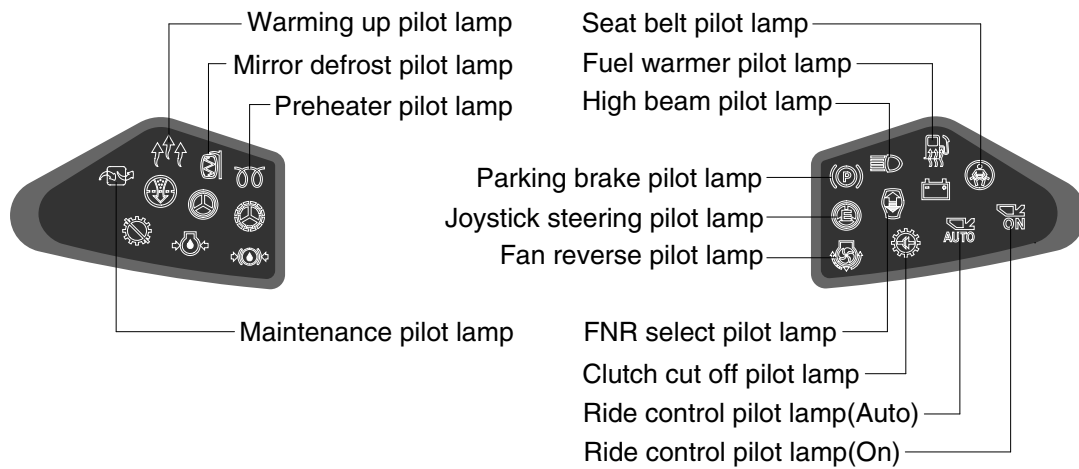

75793CD10

(1) Warming up pilot lamp

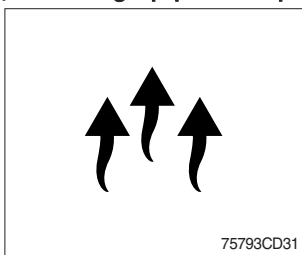

- ① This lamp is turned ON when the coolant temperature is below 30°C (86°F).
 - ② The automatic warming up is cancelled when the engine coolant temperature is above 60°C, or when 10 minutes have passed since starting the engine.
- ※ Automatic warming up condition
- Gear selector is in neutral position.
 - Parking brake is applied.
- Refer to page 7-32.

(2) Seat belt pilot lamp



- ① This lamp lights ON for the first five seconds after starting the engine.

(3) Mirror defrost pilot lamp

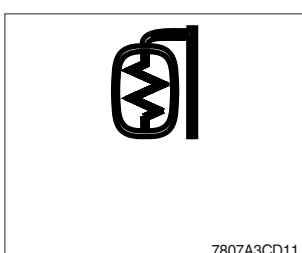

- ① This lamp comes ON when mirror defrost switch is pressed.

(4) High beam pilot lamp

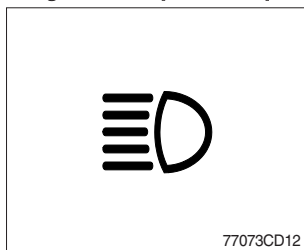

- ① This lamp works when the illuminating direction is upward.
- ② This lamp comes ON when the dimmer switch is operated, e.g., when passing another vehicle.

(5) Preheat pilot lamp

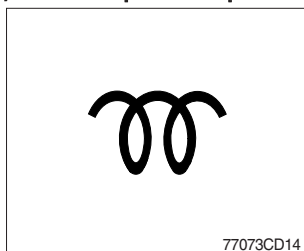

- ① This lamp lights ON when start switch is turned clockwise to the ON position. Light will turn off after approximately 5~45 seconds, depending on engine temperature, indicating that preheating is completed.
- ② When the lamp goes out the operator should start cranking the engine.

(6) Parking brake pilot lamp



- ① When the parking brake is actuated, the lamp lights ON.
- ※ Check the lamp is OFF before driving.

(7) Maintenance pilot lamp

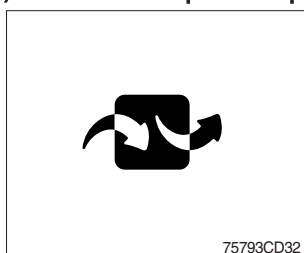

- ① This lamp will be ON when the consuming parts are needed to change or replace. It means that the change or replacement interval of the consuming parts remains below 30 hours.
- ② Check the message in maintenance information of the monitor menu. Also, this lamp lights ON for 3 minutes when the start switch is ON position.

(8) Clutch cut off pilot lamp

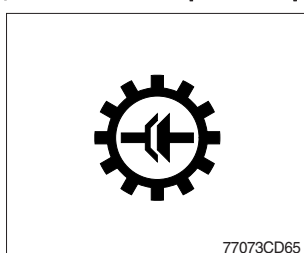

- ① This lamp lights ON when the clutch cut off mode switch is positioned L, M, H.
- ※ Refer to page 7-48.

(9) FNR select pilot lamp (option)

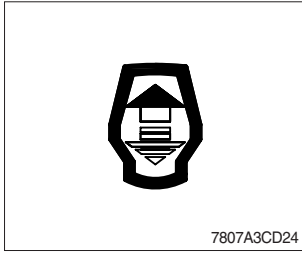

- ① The lamp comes ON when FNR select button on the optional FNR remote control lever is pressed.

(10) Joystick steering pilot lamp (option)

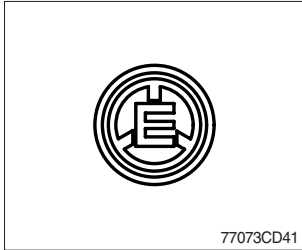

- ① This lamp lights ON when joystick steering is activated. It is then possible to steer the machine and select gears from the armrest to the left of the operator's seat.

(11) Ride control pilot lamp (option)

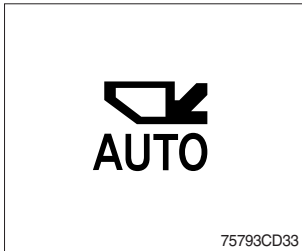

- ① **Auto ride control**
This lamp lights ON when push in the bottom of the ride control switch (auto position).
※ Refer to page 7-47.

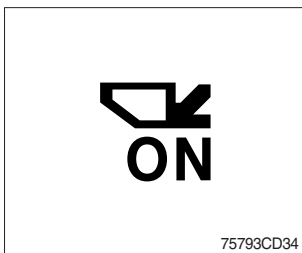

- ② **Manual ride control**
This lamp lights ON when push in the top of the ride control switch (manual position)
※ Refer to page 7-47.

(12) Fan reverse pilot lamp



- ① This lamp lights ON when the fan control switch is pressed.
※ Refer to page 7-46.

(13) Fuel warmer pilot lamp

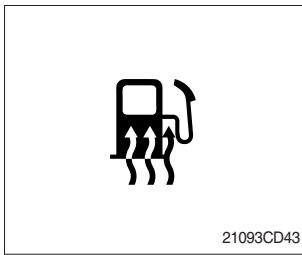

- ① This lamp is turned ON when the coolant temperature is below 10°C (50°F) or the hydraulic oil temperature 20°C (68°F).
- ② The automatic fuel warming is cancelled when the engine coolant temperature is above 60°C and the hydraulic oil temperature is above 45°C since the start switch was ON position.

5) LCD

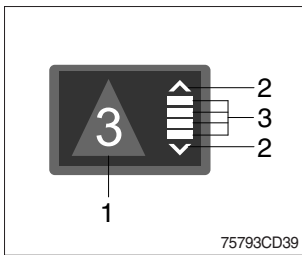

- (1) The LCD can be used with the gear selector.
It indicates speed and driving direction.

No	Symbol	Meaning	Remark
1	△, ▽, □	Actual gear display	Forward, reverse, neutral
	1, 2, 3, 4		Actual gear
	P		Parking brake mode active
2	▲, ▼	Forward, reverse	Automatic mode
3	▬, ▬, ▬, ▬	Gear range display	Automatic mode

2. MONITOR

- The monitor is adjustable.
 - Vertical : 14°
 - Horizontal : 30°



75793CD23

1) BUTTONS

(1) Menu button



- ① Main display to main menu, main menu to main display.
- ② AEB cancel button in AEB setting.

(2) Left move button



- ① Move in menu (left, up).

(3) Camera / ESC button



- ① Enter rear camera mode in main display.
- ② Cancel button except in main display (move previous menu).

(4) Right move / Buzzer stop button



- ① Move in menu (right, down).
- ② Buzzer stop.

(5) Enter button



- ① Select menu (enter).
- ② AEB cancel button in AEB setting.

2) MAIN MENU

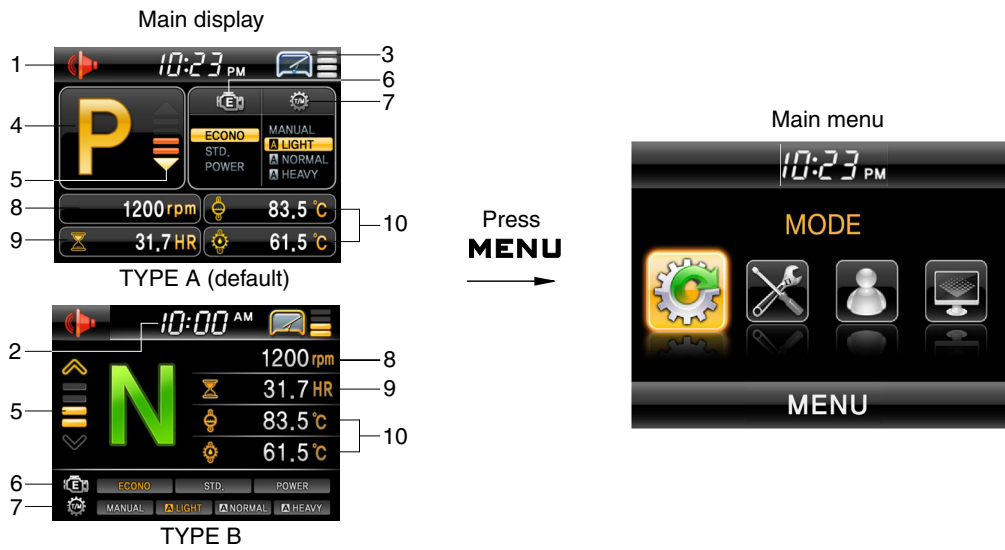





75793CD11

- | | | |
|---------------|---------------------|------------------------|
| 1 Buzzer | 5 Select gear | 9 Hour meter, odometer |
| 2 Clock | 6 Engine mode | 10 Monitoring |
| 3 Wiper speed | 7 Transmission mode | |
| 4 Actual gear | 8 Engine rpm | |

※ Display type can be changed by operator. See page 7-42.

(1) Structure

No	Main menu	Sub menu	Description
1	 MODE 75793CD12	Engine setting Kick down setting Wiper speed setting AEB setting Speed meter setting Sensor calibration	Engine warming up, Engine speed Mode 1 (down/up), Mode 2 (down only) 4 steps AEB setting Pulse setting Boom/bucket angle, Boom pressure calibration
2	 MONITORING 75793CD13	Fault code Machine monitoring Record monitoring	Machine, TCU, ECU, SCU Hyd temp, Battery, Coolant temp T/M oil temp, Weighing system Hour meter, ODO meter
3	 MANAGEMENT 75793CD14	Machine security Maintenance Machine information Service contact Service	ESL system setting, Change password Replacement, Change interval (oils and filters) Version, Status Service contact S/W download
4	 DISPLAY SET UP 75793CD13	Clock Display setting Unit setting Rear camera setting Language setting	Clock Brightness setting (Manual/Automatic) Type display (A or B type) Temp (°F/°C), Distance (km/mile), Pressure (bar, Mpa, kgf/m ² , psi) Reverse mode, Active camera, Display order 12 languages

(2) Mode

① Engine setting



※ If the starting switch is OFF, engine warming-up setting will automatically reset to OFF.



Set low idling speed

② Kick down setting



- Mode 1 (down/up) : Press kick down button once, shift down and press button again, shift up.
- Mode 2 (down only) : Press kick down button every time, shift to lower gear respectively.

※ Refer to page 7-50.

③ Wiper speed setting

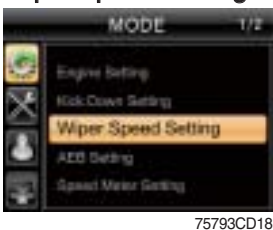

- Setting wipe speed 1 to 4.

④ Fan-auto mode



- Select reverse interval or reverse time.
- Set reverse interval (30~300 min) or reverse time (30~300 sec).

※ Default : Interval (60 min), time (120 sec)

※ Refer to page 7-46, fan control switch.

⑤ AEB setting



- AEB mode controls the disk clearance of the transmission, automatically.
- To start AEB setting, press and hold for 3 seconds.
- To cancel AEB setting, press **MENU**, /**ESC** or .
- If "OK" in actual gear window, press **MENU**, /**ESC** or to complete AEB setting.
- **Display during AEB mode**

Symbol	Meaning
ST	Start AEB
K1~K4, KV, KR	Calibrating clutch K1~K4, KV or KR respectively
OK*	Calibration for all clutches finished
Spanner and Kx*	Kx couldn't be calibrated, AEB finished
△E	Engine speed too low - Raise engine speed
▽E	Engine speed too high - Lower engine speed
△T	Transmission oil temperature too low - Heat up transmission
▽T	Transmission oil temperature too high - Cool down transmission
FO*	Output speed not zero
FN*	Shift lever not in neutral position
FP*	Parking brake not applied

* : Transmission stays in neutral, you have to restart the TCU (ignition off/on).

⑥ Speed meter setting



- Press and hold for 3 seconds.
- To change the pulse value, press or .
- To change the position, press .
- ※ Only for the serviceperson.

⑦ Sensor calibration

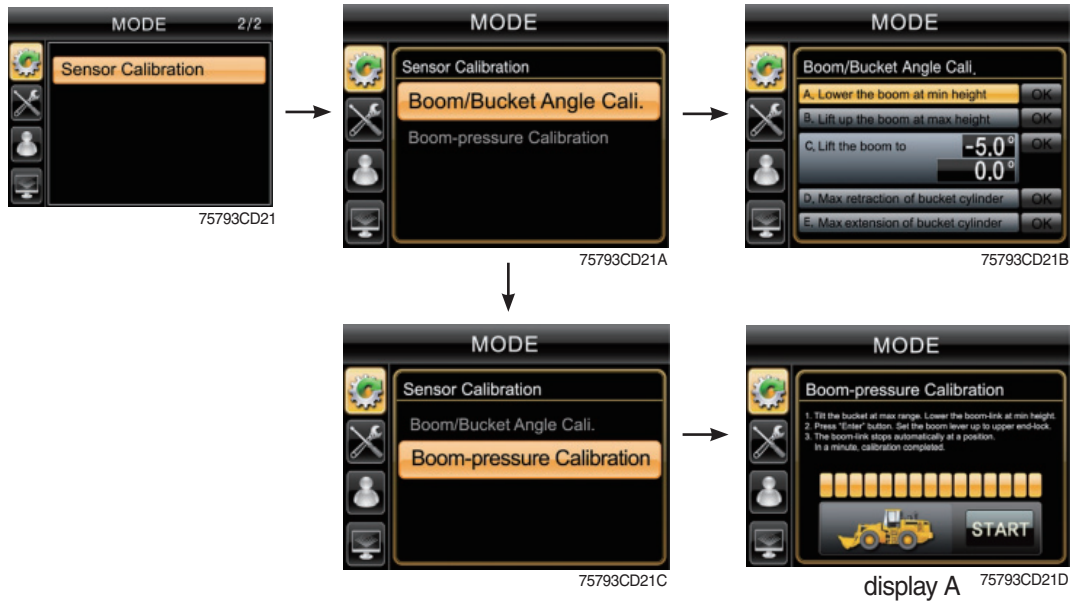

• Boom / Bucket angle calibration

- CPU get sensing signal from boom link angle and bell crank angle and calculate bucket cylinder stroke and boom link position angle from ground real time basis.
- Boom link angle position and bucket cylinder stroke is set by boom kickout & bucket leveler set switch in cab.
- Individual setting position is done by lever solenoid (detent, release operation).
- Angle sensor calibration is basically carried out before delivery of the machine.

When angle sensor is replaced or actual value is different compared to setting value, this function can be done.

- The calibration must be carried out as follows :

- ① Lower the boom at maximum low position and select (bucket must be max tilting position).
- ② Raise boom at maximum high position and select .
- ③ Position boom at -5° and select .
- ④ Retract bucket cylinder length (to minimum position) at -5° boom position and select .
- ⑤ Extend bucket cylinder length (to maximum position) at -5° boom position and select .
- ⑥ In case above steps are carried normally, "complete" message is shown. Then angle sensor calibration is finished after selecting .

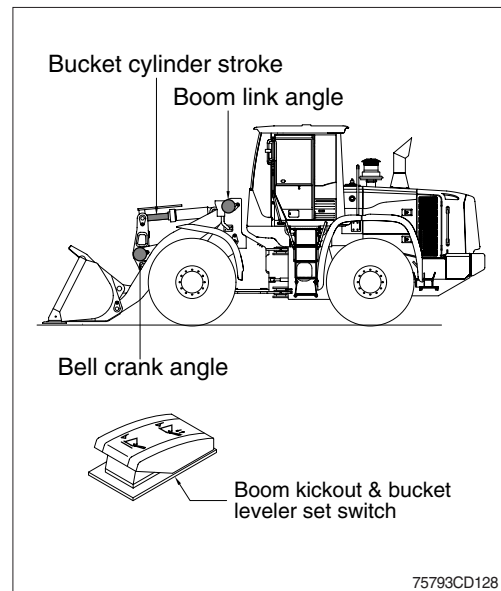



75793CD128

· **Boom pressure calibration**

- It is used when bucket weight is changed or measured weight is inaccurate.

- The calibration must be carried out as follows :

- ① Increase hydraulic temperature (about 30 ~ 60 °C).
- ② Select "Boom-pressure calibration".
- ③ Place the boom at low position with bucket completely rolled in (max tilting position).
- ④ Press .
- ⑤ Raise boom to maximum position. Boom up must be finished before stepping advance in "display A".
- ⑥ If it show "Succeed" message in a moment, press .

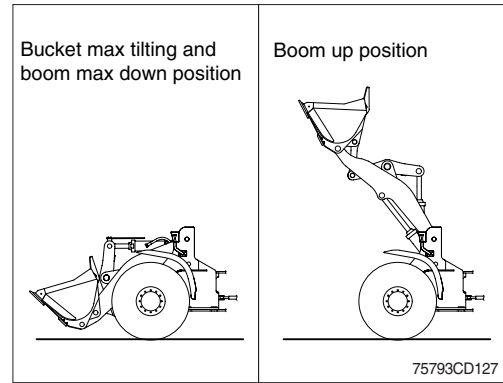

- ※ Raise hydraulic temperature enough when checking work load / boom pressure sensor calibration (recommendation : about 30 ~ 60 °C).
- ※ Check if pressure sensor or angle sensor is in normal condition for accurate work load algorism or pressure sensor calibration (pressure sensors at boom cylinder head area and rod area, boom link angle sensor (CD-80), bell crank angle sensor (CD-81)).
- ※ Sensor error message during pressure sensor calibration : sensor need to be checked.

(3) Monitoring

① **Fault code**

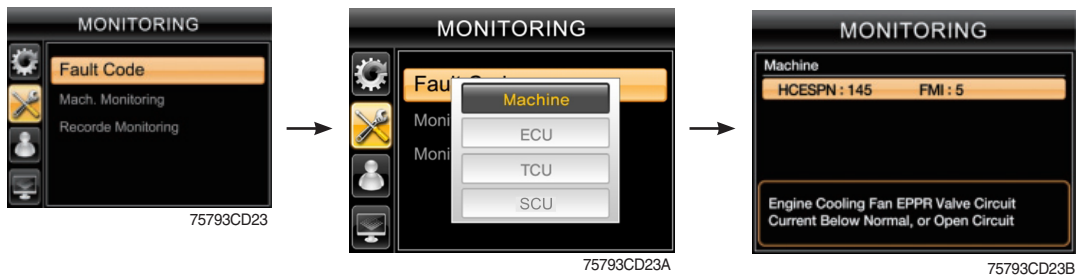

- Monitor the fault code of the Machine/ECU/TCU/SCU.
- ※ **Not define will be indicated in case of that there's no fault.**

② **Machine monitoring**

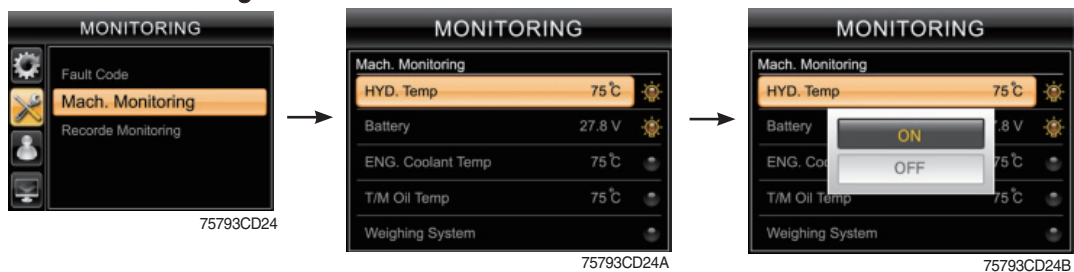

- Monitor the status of the machine.
- To check the item in main display, choose it and press .
- The right icon shows ON/OFF status.

※ Priority in the main display



The example of the weighing system

- The priority of the weighing system is the highest.
- If selected the weighing system, the other items are not available.
- To check the other items, the weighing system should not be selected.

※ Weighing system

1. PRINCIPLE

- 1) The weight indication in bucket is calculated by measuring boom position and boom pressure.
 - (1) The weight is '0.0 ton' when the boom is placed at below -15° .
 - (2) The weight is indicated when the boom is placed at the range $(-5^{\circ} \rightarrow 15^{\circ})$.
 - (3) The weight is calculated when the boom is placed at above -5° and boom is lowered below -15° after dumping operation.
 In order to re check weight, go to the (2) after changing boom position (below -15°).
 (The other way is to select  of monitor and go to (2) in case boom is placed at above -5°).
- 2) Dump operation : It is checked by bucket cylinder's stroke change (below 250 mm).

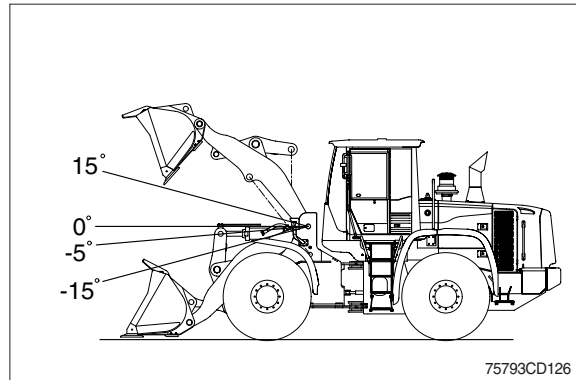

75793CD126

2. MONITOR DISPLAY

- 1) When pressing work load button for over 2 seconds, the weight is shown sequence basis.
(main display 1 → 2 → 3 → 4 → 1)



	Work weight (today)
	Work weight (previous day)
	Total weight accumulated in memory A, B, C individually regardless of date
	Current weight

- 2) Default accumulated value at memory A, B, C when pressing work load button for over 2 seconds (default : 0.0 ton).

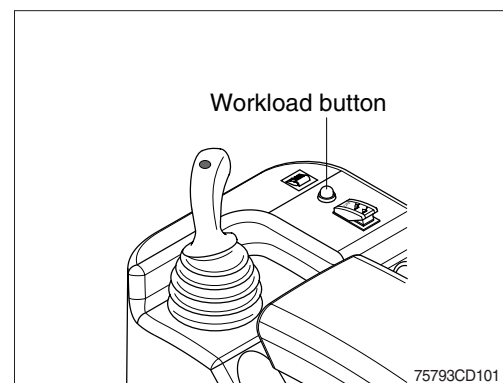

③ Record monitoring

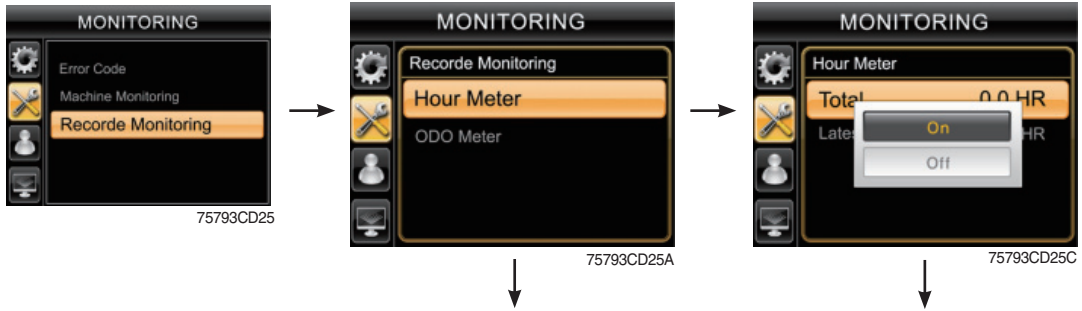

· Hour meter

- **Total** : total hour meter

To show the item in the main display, select "ON" and press (this item could not reset).

- **Latest** : the latest hour meter after reset.

To show the item in the main display, select "ON" and press .

To reset the latest hour meter, select "initializing" and press .



· ODO meter

- **Total** : total ODO meter

To show the item in the main display, select "ON" and press (this item could not reset).

- **Latest** : the latest ODO meter after reset.

To show the item in the main display, select "ON" and press .

To reset the latest odometer, select "initializing" and press .



(4) Management

① Machine security

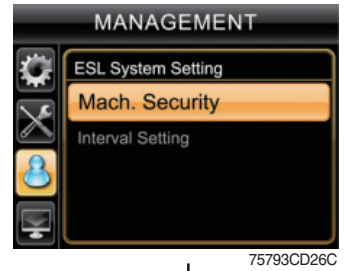

· ESL system setting

- ESL : Engine Starting Limit
- ESL mode is designed to be a theft deterrent or will prevent the unauthorized operation of the machine.
- If the ESL mode was selected Enable, the password will be required when the start switch is turned ON.
- Disable : Not used ESL function
- Enable : The password is required whenever the operator start engine.

Interval mode : The password is required when the operator start engine first. But the operator can restart the engine within the interval time without inputting the password.
The interval time can be set maximum 2 days.

※ **Default password : 00000 ***

· Interval setting

- If set interval setting to 5 minutes, ESL system is activated after 5 minutes.
- Therefore, the password does not need to restart engine within 5 minutes.

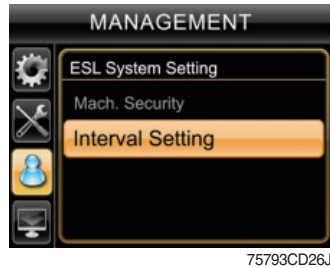

- **Change password**
 - Input 5 to 10 digits and press *.

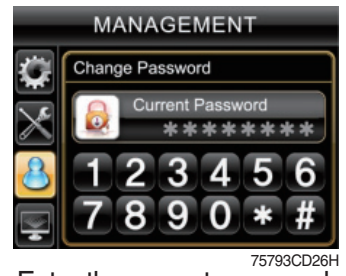

Enter the current password.



Enter the new password.



The new password is stored in the MCU.



Enter the new password again.

② Maintenance

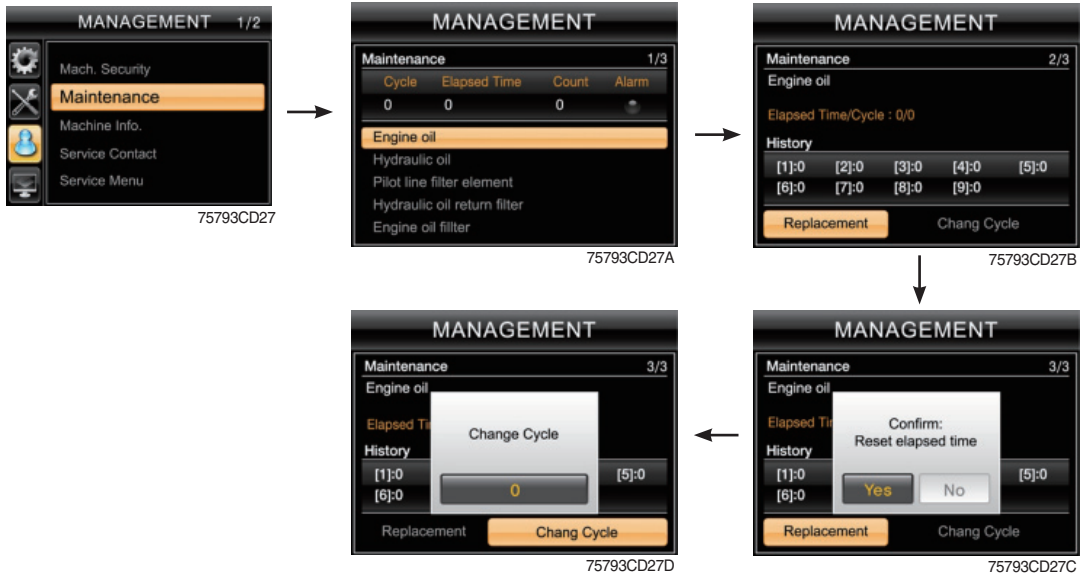

- Alarm (⚙️) : Warning
Replacement : The elapsed time will be reset to zero.
Change cycle : The change or replace cycle can be changed in the unit of 50 hours.
- To change cycle, press ◀ or ▶/⏹.
- **Change or replace interval**

No	Item	Interval
1	Engine oil	500
2	Hydraulic oil	★ ¹ 2000 ★ ² 5000
3	Pilot line filter element	1000
4	Hydraulic oil return filter	1000
5	Engine oil filter	500
6	Fuel filter element	500
7	Fuel pre-filter	500
8	Hydraulic tank air breather	250
9	Radiator coolant	2000
10	Transmission oil and filter	1000
11	Axle oil (front and rear)	1500

★¹ : Conventional hydraulic oil

★² : Hyundai genuine long life hydraulic oil

③ Machine information

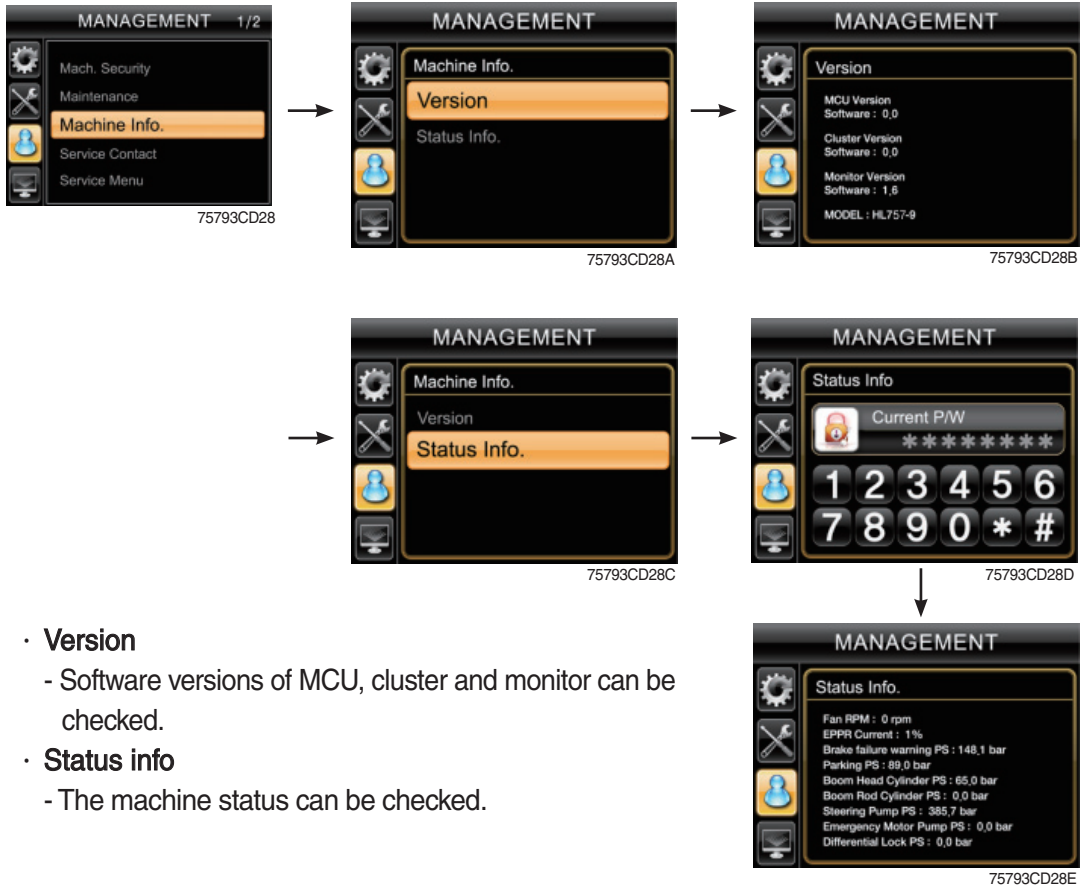

④ Service contact

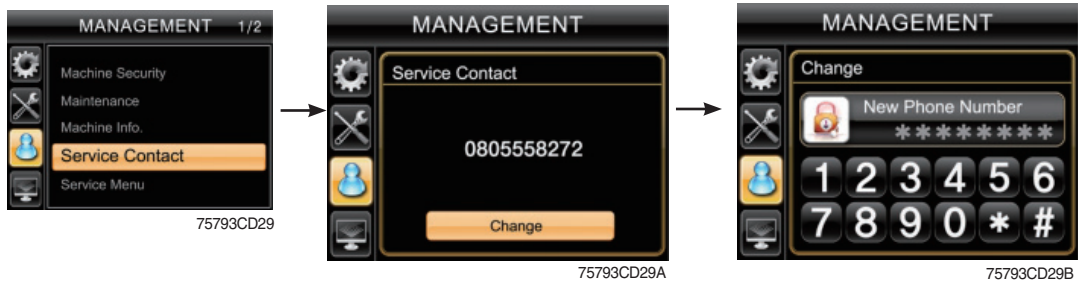

⑤ Service menu



(5) DISPLAY SET UP

① Clock

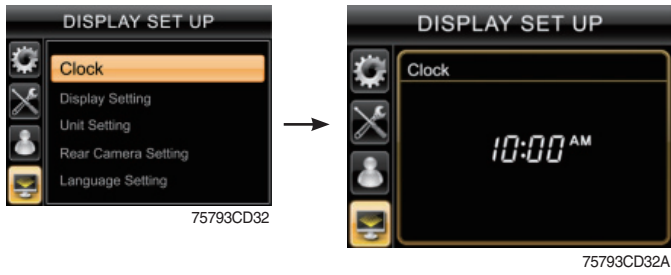

- To set time, press ◀ or ▶/⌂.
- To move position, press ⌂.

② Display setting

· Brightness setting

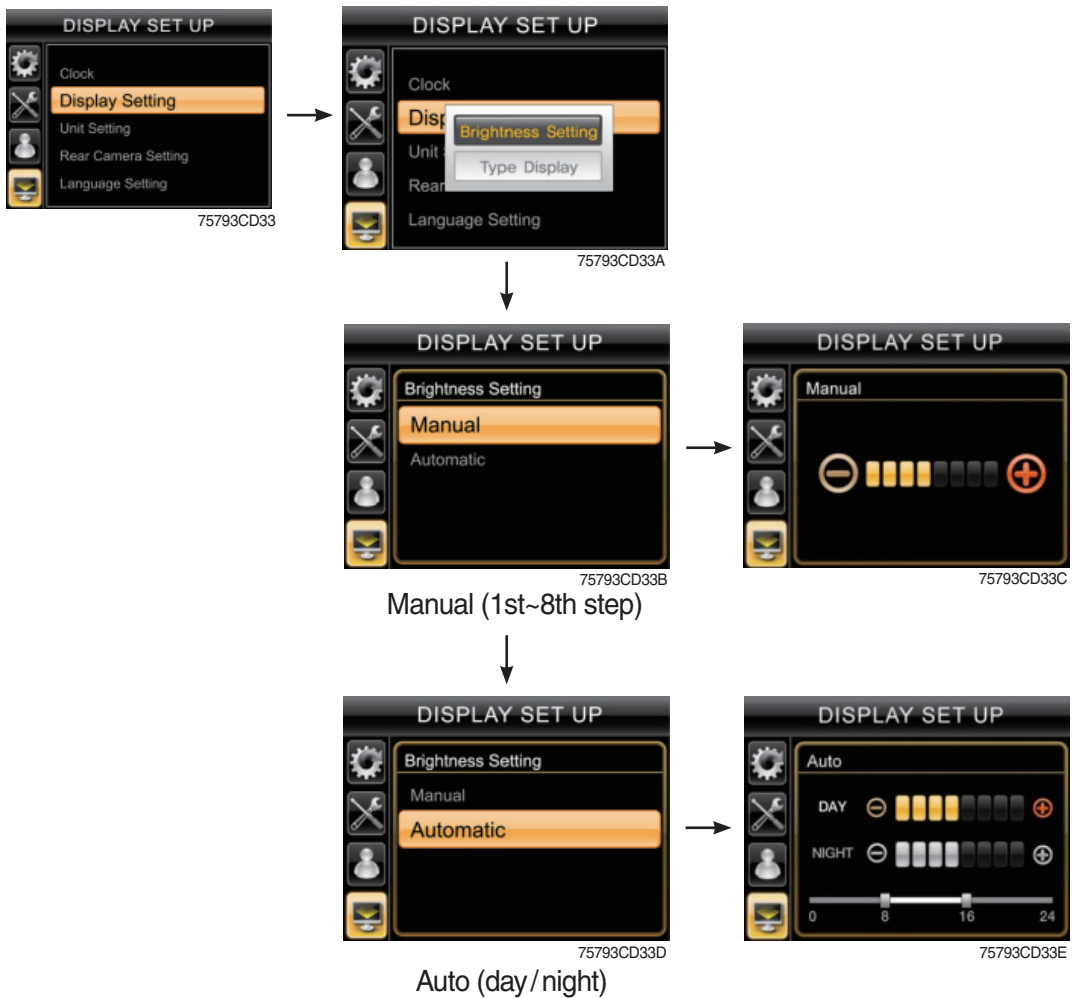

- ※ If "Automatic" is chosen, brightness for day and night can be differently set up. Also by using the bar in lower side, users can define which time interval belongs to day and night. (in bar figure, gray area represents night time while white shows day time)

· Display type setting



A type



B type

③ Unit setting



- Temperature : °C ↔ °F
- Distance : km ↔ mile
- Pressure : bar ↔ Mpa ↔ kgf/m² ↔ psi

④ Rear camera setting



- **Reverse mode**
 - If transmission engages the reverse gear (R1~R3), the camera mode is displayed automatically in main display.
- **Active camera**
 - Three cameras can be installed on the machine.
 - The display order can be set by this menu.
 - If the camera was not equipped, this menu is not useful.
 - In main display, if the **ESC** button is pushed, the first ordered display camera will be viewed.

⑤ Language setting



- User can select preferable language and all display are changed the selected language.

3. SWITCHES

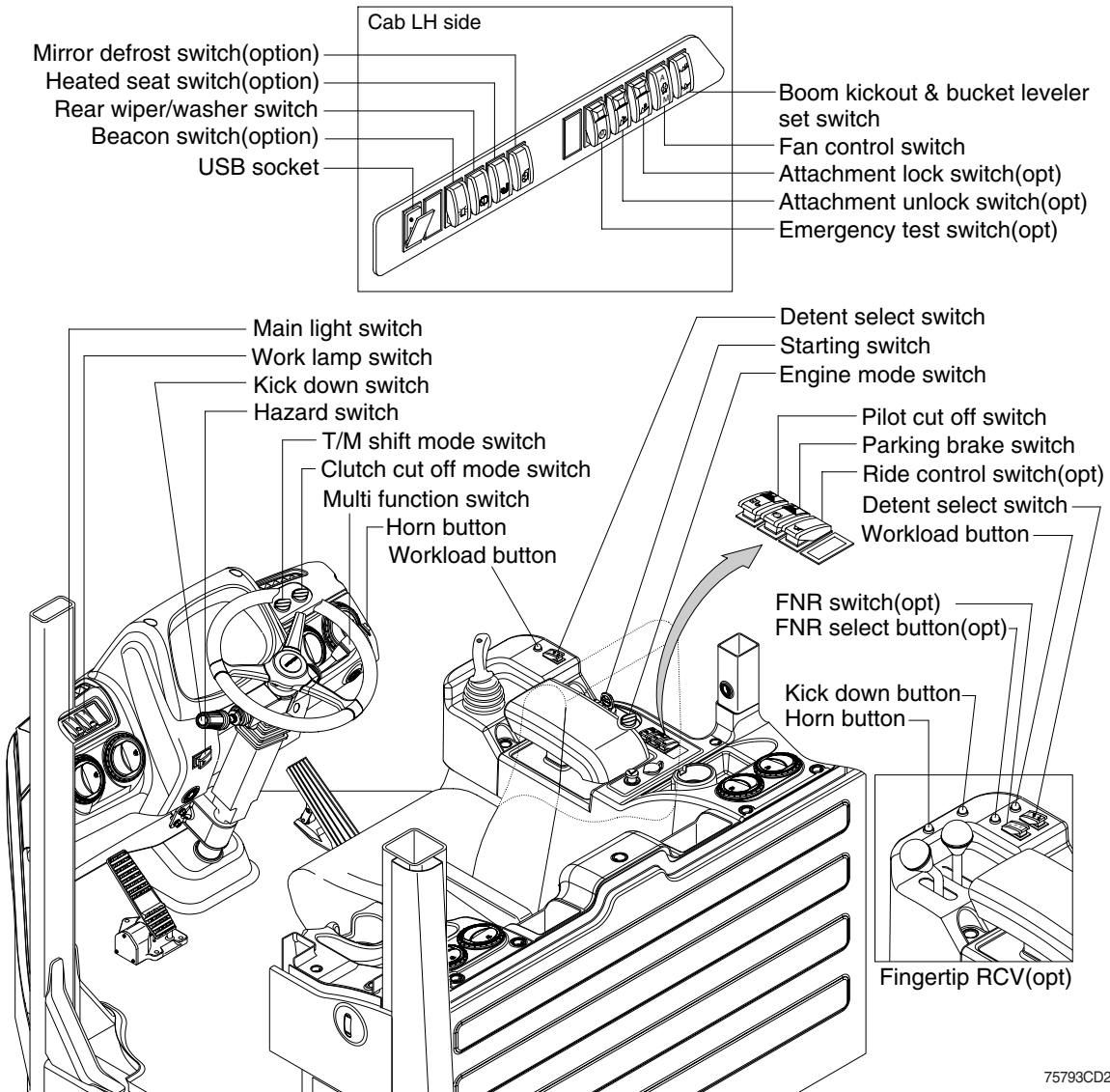

75793CD29-1

1) STARTING SWITCH

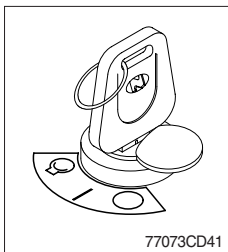

(1) There are three positions, OFF, ON and START.

- ○ (OFF) : None of electrical circuits activate.
- | (ON) : All the systems of machine operate.
- ◌ (START) : Use when starting the engine.

Release key immediately after starting.

- ※ If you turn ON the starting switch in cold weather, the fuel warmer is automatically operated to heat the fuel by sensing the coolant temperature. Start the engine in 1~2 minutes after turning ON the starting switch. More time may take according to ambient temperature.
- ※ Key must be in the ON position with engine running maintain electrical and hydraulic function and prevent serious machine damage.

2) HAZARD SWITCH

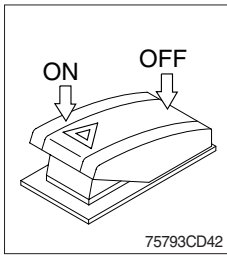

- (1) Use for parking, or roading the machine.
 - (2) Both turn signal lights will flash simultaneously.
- ※ If the switch is left ON for a long time, the battery may be discharged.

3) PILOT CUT OFF SWITCH

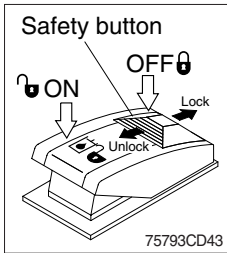

- (1) When the switch is pressed to OFF position, the hydraulic pilot line will be cut off, so the work equipment will not operate.
- (2) Press the ON position in order to unlock the hydraulic pilot line.

4) PARKING BRAKE SWITCH

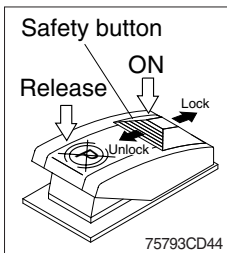

- (1) When the switch is pressed to ON position, the parking brake will start to operate and the cluster warning lamp will come ON.
 - (2) Press the release position in order to disengage the parking brake.
- ※ When operating the gear selector lever, be sure to release the parking brake. If the machine is operated with the parking brake engaged, the brake will overheat and may cause the brake system to go out of order.

5) MAIN LIGHT SWITCH

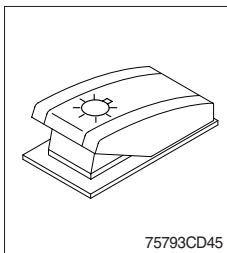

- (1) This switch is used to operate the clearance lamp and head light by two steps.
 - **First step** : Clearance lamp and cluster illumination lamp come ON. Also, all indicator lamp of switches come ON.
 - **Second step** : Head light comes ON.

6) WORK LAMP SWITCH

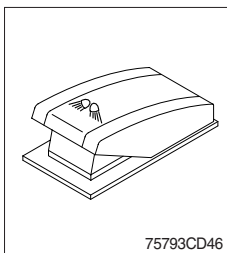

- (1) This switch is used to operate the front and rear work lamps by two steps.
 - **First step** : Front work lamp located on the cab comes ON.
 - **Second step** : Rear work lamp located on the cowl comes ON.

7) REAR WIPER AND WASHER SWITCH

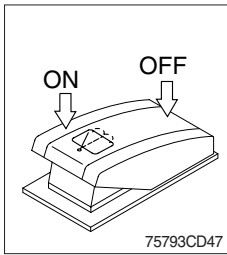

- (1) The switch use to operates the rear wiper and washer by two step.
 - **First step** : The rear wiper operates.
 - **Second step** : The washer liquid is sprayed and the rear wiper is operated only while pressing. If release the switch, return to the first step position.

8) FAN CONTROL SWITCH

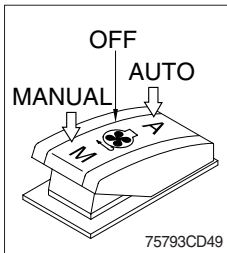

- (1) This switch use to control the cooling fan.
- (2) This switch has three positions.
 - **AUTO** : The fan automatically work in reverse according to set up interval and time.
 - ※ Refer to page 7-33.
 - **OFF** : Only forward rotation is possible.
 - **MANUAL** : The fan rotates reverse only while pressing this position. If release the switch, return to the OFF position.
- (3) On pressing the switch, the indicator lamp is turned ON.

9) DETENT SELECT SWITCH

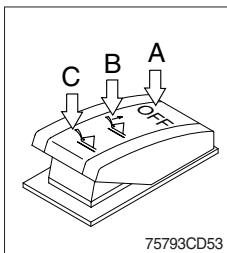

- (1) This switch is used to select the detent functions.
- (2) This switch has three positions.
 - **A** : Detent functions are not operated.
 - **B** : Only boom detent function is operated.
 - **C** : Boom and bucket detent functions are operated.

10) MIRROR DEFROST SWITCH (option)

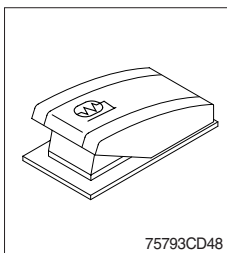

- (1) If the mirror defrost switch is pressed in condition of key ON, it operates for 15 minutes. After 15 minutes, the defrost function stops automatically.
- (2) One more pressing the switch in operation also stops defrost function.
- (3) On pressing the switch, the indicator lamp is turned ON.

11) BEACON SWITCH (option)

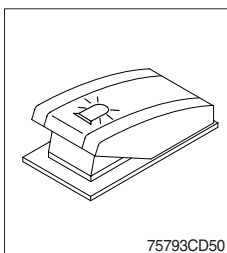

- (1) This switch turns ON the rotary light on the cab.

12) RIDE CONTROL SWITCH (option)

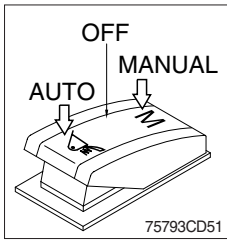

(1) AUTO

Press in the bottom of the ride control switch in order to turn on the automatic ride control. The automatic ride control automatically turns on when the travel speed exceeds a preset speed of approximately 7 km/h. The automatic ride control automatically shuts off during low speed 7 km/h travel mode.

(2) MANUAL

Press in the top of the ride control switch in order to turn on the system for ride control regardless speed. The ride control will smooth the ride of the machine during travel.

(3) OFF

Press the ride control switch to the middle position in order to turn off the system for the ride control.

13) EMERGENCY TEST SWITCH (option)

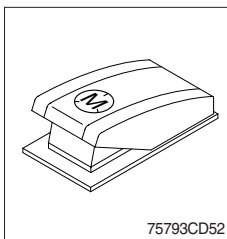

(1) The emergency steering system can be manually tested. Push the switch in order to determine if the emergency steering and the emergency steering lamp are functional.

(2) When the switch is pressed, the emergency steering pump motor will run. The emergency steering lamp will light. If the emergency steering lamp does not light, do not operate the machine.

14) ATTACHMENT LOCK SWITCH (option)

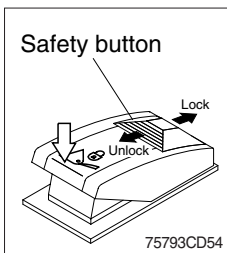

(1) Press this switch in order to engage the quick coupler pins.

(2) If this switch is pressed for 5 seconds, the quick coupler pins move in the engaged position.

If the switch is released, the quick coupler pins will remain in the engaged position.

※ **Check for engagement as followings.**

- ① Put down pressure on the attachment.
- ② Back up the machine and make sure that there is no movement between the quick coupler and attachment.

15) ATTACHMENT UNLOCK SWITCH (option)

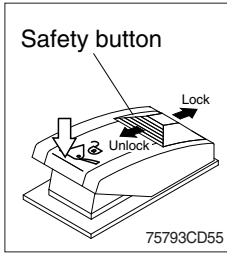

- (1) Press this switch in order to disengage the quick coupler pins.
 - (2) If this switch is pressed for 5 seconds, the quick coupler pins move in the disengaged position.
If the switch is released, the quick coupler pins will remain in the disengaged position. (Machine serial No. : ~#0683)
If the switch is released, the quick coupler pins will slowly extend to the engaged/locked position. (Machine serial No. : #0684~)
- ※ **This switch can be pressed only when the safety button is pulled to the unlock position.**

16) BOOM KICK OUT AND BUCKET LEVELER SET SWITCH

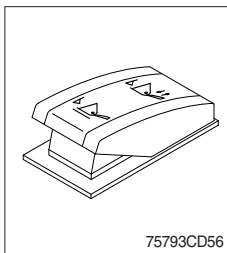

- (1) Press this switch in order to set the boom kickout and bucket leverer.
- ※ **Refer to page 6-53.**

17) ENGINE MODE SWITCH

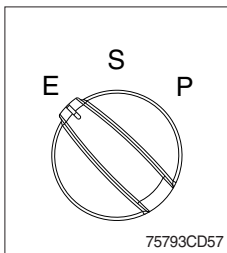

- (1) The operator can adjust the machine's performance with this dial switch.
 - P (Power) : Maximum power output for hard digging operation or hill climb.
 - S (Standard) : General digging and loading operation.
 - E (Econo) : Maximum fuel efficiency for general loading.

18) CLUTCH CUT OFF MODE SWITCH

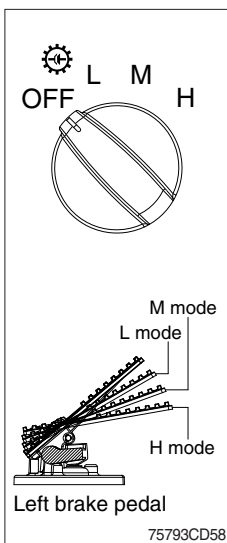

- (1) Four modes are available for operator's preference and job condition.
 - OFF : The clutch cut off function is disable.
 - L (Low) : The clutch is disengaged early for short-distance and rapid loading.
 - M (Medium) : The clutch is disengaged normally for general digging and loading operation.
 - H (High) : The clutch is disengaged lately for slope ground.
- (2) The clutch cut off functions of the left brake pedal depend on the position of the left brake pedal and the position of the clutch cut off mode switch.

Positions for clutch cut off function			
Clutch cut off mode switch	L	M	H
Left brake pedal	L, M, H	M, H	H

19) TRANSMISSION SHIFT MODE SWITCH

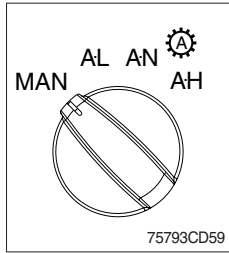

(1) Four modes are available for operator's preference and job condition.

- MAN (Manual) : Machine is operated by selected gear on lever.
- AL (Auto Light) : Automatic shifting point is fast for long-distance transportation and fuel efficiency.
- AN (Auto Normal) : Automatic shifting point is normal without automatic kick-down to 1st gear for general digging and loading operation.
- AH (Auto Heavy) : Automatic shifting point is normal with automatic kick-down to 1st gear for more powerful operation.

20) HORN BUTTON

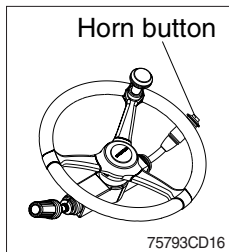

(1) If you press the button on the top of the multifunction switch, the horn will sound.

21) CAB LAMP SWITCH

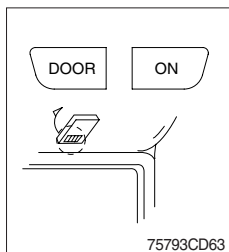

(1) This switch turns ON the cab room lamp.

① DOOR

The lamp comes ON when the door is opened.

When the door is closed the lamp is OFF.

② ON

This switch is used to turn the lamp ON or OFF.

22) KICK DOWN SWITCH

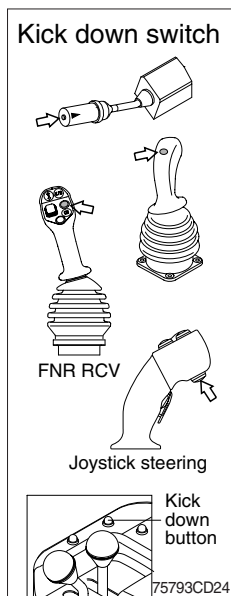

(1) Manual mode

It is effective 2nd speed to 1st speed only and recover to 2nd speed quickly when push the switch one more time.

(2) Automatic mode

① Mode 1 (down/up)

It shifts down quickly from current gear to one step lower speed by pushing the switch and recover to current speed quickly when push the switch one more time.

② Mode 2 (down)

It shifts down from current gear to one step lower speed when push the switch every time.

The kick down function is released in only 1st speed.

※ Refer to page 7-32 for the kick down setting.

※ The normal autoshift function continues after the kick down switch is released.

23) MULTI FUNCTION SWITCH

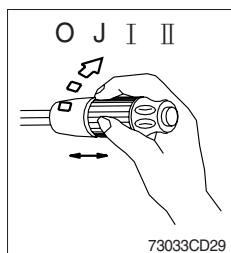

(1) Front wiper and washer switch

- ① When the switch is in J position, the wiper moves intermittently.
- ② When placed in I or II position, the wiper moves continuously.
- ③ If you push the grip of the lever, washer liquid will be sprayed and the wiper will be activated 2-3 times.

※ Check the quantity of washer liquid in the tank. If the level of the washer liquid is LOW, add the washer liquid (in cold, winter days) or water. The capacity of the tank is 1 liter.

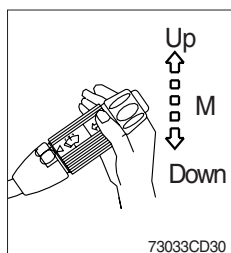

(2) Dimmer switch

- ① This switch is used to turn the head lights direction.

② Switch positions

- Up : To flash for passing
- Middle : Head lights low beam ON
- Down : Head lights high beam ON

- ③ If you release the switch when it's in up position, the switch will return to middle.

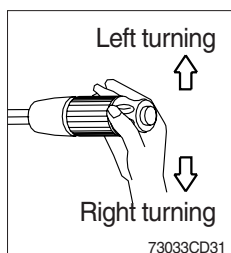

(3) Turning switch

- ① This switch is used to warn or signal the turning direction of the machine to other vehicles or equipment.
- ② Push the lever up for turning left, pull the lever down for turning right.