

GROUP 2 OPERATIONAL CHECKS AND TROUBLESHOOTING

1. OPERATIONAL CHECKS

This procedure is designed so the mechanic can make a quick check of the system using a minimum amount of diagnostic equipment. If you need additional information, read **structure and function**, Group 1.

A location will be required which is level and has adequate space to complete the checks.

The engine and all other major components must be at operating temperature for some checks.

Locate system check in the left column and read completely, following the sequence from left to right. Read each check completely before performing.



At the end of each check, if no problem is found(OK), that check is complete or an additional check is needed. If problem is indicated(NOT OK), you will be given repair required and group location.

If verification is needed, you will be given next best source of information:

- Chapter 2 : Troubleshooting
- Group 3 : Tests and adjustments

※ Hydraulic oil must be at operating temperature for these checks(Refer to page 6-46).

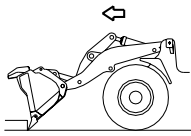
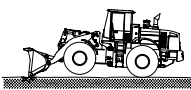
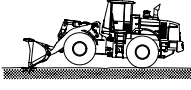
Item	Description	Service action
<p>Hydraulic system warm-up procedure Run engine at high idle. Refer to page 6-46.</p>	<p>Hold a hydraulic function over relief to heat oil.(Don't keep relief condition over 5 seconds at a time)</p> <p>Periodically cycle all hydraulic functions to distribute warm oil.</p> <p>Repeat procedure until oil is at operating temperature.</p> <p>FEEL : Hydraulic reservoir must be uncomfortable to hold your hand against. (approximately 40 ~50°C)</p>	<p>OK Check completed.</p>
<p>Hydraulic pump performance check Heat hydraulic oil to operating temperature. Run engine at high idle.</p>	<p>With bucket flat on ground, actuate boom raise. Time how long it takes to raise boom to full height.</p> <p>LOOK : Boom must raise to full height in less than 7 seconds.</p>	<p>OK Check completed.</p> <p>NOT OK Go to priority valve(in flow amplifier) high pressure check at page 5-31.</p> <p>IF OK Do steering system leakage check at page 5-30.</p> <p>IF OK Do main hydraulic pump flow test at page 6-47.</p>
<p>Control valve lift check Run machine at low idle.</p>	<div data-bbox="509 1294 703 1379" data-label="Image"> </div> <p>With bucket partially dumped, lower boom to raise front of machine.</p> <p>Slowly move boom control lever(RCV lever) to boom lower position.</p> <p>Slowly move bucket control lever to bucket dump position.</p> <p>LOOK : Boom must not raise before moving down.</p> <p>Bucket must not rollback before dumping.</p>	<p>OK Check complete.</p> <p>NOT OK Repair lift checks in loader control valve.</p>

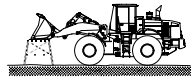
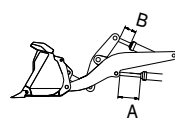
Item	Description	Service action
Bucket rollback circuit relief valve check	 <p>Position bucket at a 45° angle against an immovable object.</p> <p>Engage transmission in 3rd speed forward.</p> <p>LOOK : Bucket angle must not change.</p>	<p>OK Check complete.</p> <p>NOT OK Replace boom lower check valve.</p>
Bucket dump circuit relief valve low pressure check	 <p>Raise front of machine which bucket at 45° angle.</p> <p>Backdrag with bucket while observing bucket angle.</p> <p>LOOK : Bucket must not rollback</p>	<p>OK Go to next check.</p> <p>NOT OK Do loader system and circuit relief valve test at page 6-48.</p>
Pilot control valve float check Run engine at low idle.	  <p>With the bucket partially dumped, lower boom to raise front of machine.</p> <p>Push control lever to the float detent position and release lever.</p> <p>LOOK : Front of machine lower to the ground and valve must remain in float position when lever is released.</p>	<p>OK Check complete.</p> <p>NOT OK Do pilot control valve pressure test in group 3.</p>
Boom cylinder and bucket cylinder drift check Heat hydraulic oil to operating temperature.	  <p>Set the boom and bucket horizontal, then stop the engine.</p> <p>Stop the engine, wait for 5 minutes, then start measuring.</p> <p>Measure the amount the lift and dump cylinder rods retract during 15 minutes.(Unloaded bucket)</p> <p>A : Retraction of boom cylinder rod</p> <p>B : Retraction of bucket cylinder rod</p> <p>Boom cylinder must drift less than 40mm</p> <p>Bucket cylinder must drift less than 40mm</p>	<p>OK Check complete.</p> <p>NOT OK Go to next check.</p>

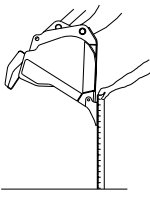
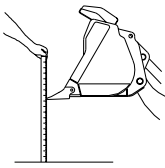
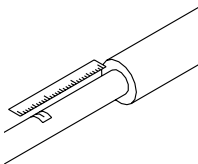
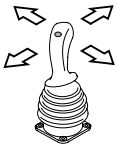
Item	Description	Service action
<p>Boom cylinder leakage check</p> <p>Heat hydraulic oil to operating temperature.</p>	 <p>Dump bucket until teeth or cutting edge is perpendicular to the ground.</p> <p>Raise boom until cutting edge is about 1m(3ft) above ground.</p> <p>Stop engine. Measure drift from tooth or cutting edge to ground for 1 minute.</p> <p>Wait 10 minutes.</p> <p>Measure drift from tooth or cutting edge to ground for 1 minute.</p> <p>LOOK : Compare the drift rate between the first measurement and the second measurement.</p>	<p>OK</p> <p>Drift is approximately the same between first and second measurement.</p> <p>Repair loader control valve or circuit relief valve.</p> <p>NOT OK</p> <p>If drift is considerably less on second measurement, repair cylinder.</p>
<p>Bucket cylinder leakage check</p> <p>Heat hydraulic oil to operating temperature.</p>	 <p>Raise bucket about 1m(3ft) off ground with bucket level.</p> <p>Stop engine. Place a support under boom.</p> <p>Measure drift from tooth or cutting edge to ground for 1 minute.</p> <p>Wait 10 minutes.</p> <p>Measure drift from tooth or cutting edge to ground for 1 minute.</p> <p>LOOK : Compare the drift rates between the first measurement and the second measurement.</p>	<p>OK</p> <p>Drift is approximately the same between first and second measurement.</p> <p>Repair loader control valve or circuit relief valve at page 6-48.</p> <p>NOT OK</p> <p>Drift is considerably less on second measurement.</p> <p>Repair cylinder.</p>
<p>Check valve of safety valve leakage check</p> <p>Heat hydraulic oil to operating temperature.</p>	 <p>Put bucket level and position about 1.2m(4ft) above ground.</p> <p>Place a piece of tape on cylinder rod at least 51mm(2in) from rod guide.</p> <p>Run engine at low idle in safety-release position.</p> <p>LOOK : Bucket must not drift up.</p>	<p>OK</p> <p>Check complete.</p> <p>NOT OK</p> <p>Check or replace safety valve.</p>
<p>Pilot control valve (RCV lever) check</p>	 <p>Stop engine. Turn key switch to OFF position.</p> <p>Move control lever to all positions and then release.</p> <p>LOOK : Lever must return to neutral when released from all positions.</p>	<p>OK</p> <p>Check completed.</p> <p>NOT OK</p> <p>Repair pilot control valve.</p>

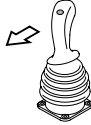
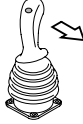
Item	Description	Service action												
<p>Bucket leveler (Positioner) check</p> <p>Run engine at low idle.</p>	 <p>Position bucket fully dumped just above ground level.</p> <p>Move control lever to bucket leveler detent position and release.</p> <p>LOOK : Bucket must rollback to the level position and control lever must return to neutral.</p> <p>If bucket is in a rolled back position when key is turned ON, control lever must be returned to neutral manually if placed in the bucket leveler detent position.</p> <p>After bucket is dumped once, bucket leveler will work normally.</p>	<p>OK Check complete.</p> <p>NOT OK Do bucket leveler checks in group 3.</p>												
<p>Boom height kickout check</p> <p>Run engine at low idle.</p>	 <p>Position bucket flat on ground.</p> <p>Move control lever to boom raise detent position and release.</p> <p>LOOK : Boom must raise to the set height and stop.</p> <p>Control lever must return to neutral.</p>	<p>OK Check complete.</p> <p>NOT OK Do boom height kickout check in group 3.</p>												
<p>Cycle time check</p> <p>Heat hydraulic oil to operating temperature. Run engine at high idle.</p>	<table border="1"> <thead> <tr> <th data-bbox="502 1084 710 1115">Function</th> <th data-bbox="710 1084 1093 1115">Operating condition.</th> </tr> </thead> <tbody> <tr> <td data-bbox="502 1133 710 1164">Boom raise</td> <td data-bbox="710 1133 1093 1164">Bucket flat on ground to full height.</td> </tr> <tr> <td data-bbox="502 1182 710 1214">Boom lower(Float)</td> <td data-bbox="710 1182 1093 1214">Full height to level ground.</td> </tr> <tr> <td data-bbox="502 1232 710 1263">Bucket dump</td> <td data-bbox="710 1232 1093 1263">Boom at full height.</td> </tr> <tr> <td data-bbox="502 1281 710 1312">Bucket rollback</td> <td data-bbox="710 1281 1093 1312">Boom at full height.</td> </tr> <tr> <td data-bbox="502 1330 710 1393">Steering(No. of turns)</td> <td data-bbox="710 1330 1093 1393">Frame stop to frame stop.</td> </tr> </tbody> </table>	Function	Operating condition.	Boom raise	Bucket flat on ground to full height.	Boom lower(Float)	Full height to level ground.	Bucket dump	Boom at full height.	Bucket rollback	Boom at full height.	Steering(No. of turns)	Frame stop to frame stop.	<p>Maximum cycle time</p> <p>6.2sec</p> <p>3.3sec</p> <p>2.0sec</p> <p>2.5sec</p> <p>3.0sec(4.5 turns)</p> <p>OK Check complete.</p> <p>NOT OK Go to slow hydraulic functions in group 3.</p>
Function	Operating condition.													
Boom raise	Bucket flat on ground to full height.													
Boom lower(Float)	Full height to level ground.													
Bucket dump	Boom at full height.													
Bucket rollback	Boom at full height.													
Steering(No. of turns)	Frame stop to frame stop.													

※ MEASURING BOOM AND BUCKET CYCLE TIME

1. MEASUREMENT CONDITION

- Coolant temperature : Inside operating range
- Steering position : Neutral
- Hydraulic temperature : 40~50°C
- Bucket : Unloaded
- Engine speed : High idling

2. MEASURING TOOL

- Stop watch(1EA)

3. MEASURING PROCEDURE

1) LIFTING TIME OF BOOM

Set the bucket near the maximum tilt back position and at the lowest position on the ground. Raise the bucket and measure the time taken for bucket to reach the maximum height of the boom.

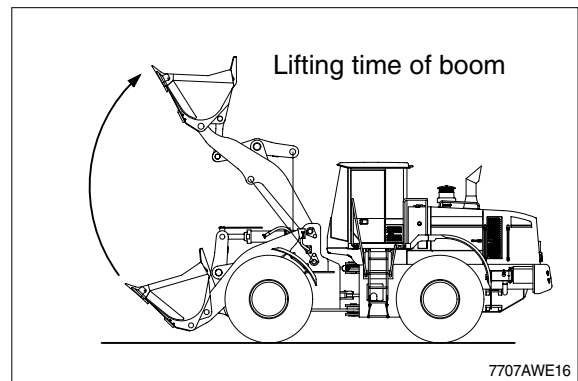

2) LOWERING TIME OF BOOM

Set the bucket horizontal with the boom at the maximum height, lower the bucket and measure the taken for the bucket to reach the lowest position on the ground.

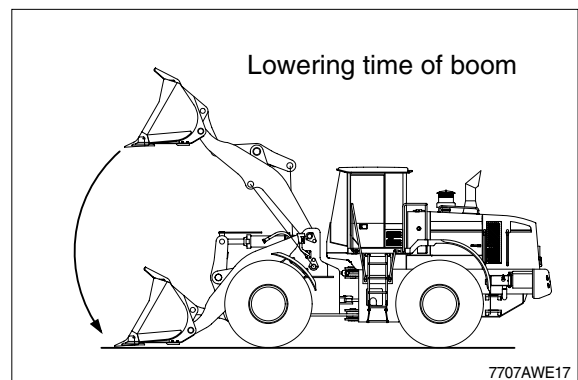

3) DUMPING TIME OF BUCKET

Raise the boom to the maximum height and measure the time taken for the bucket to move from the maximum tilt back position to the maximum dump position

4) ROLL BACK TIME OF BUCKET

Raise the boom to the maximum height and measure the time taken for the bucket to reach the maximum tilt back position.

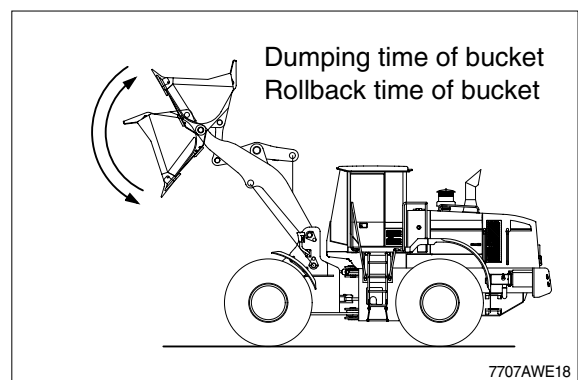

2. TROUBLESHOOTING

※ Diagnose malfunction charts are arranged from most probable and simplest to verify, to least likely, more difficult to verify. Remember the following steps when troubleshooting a problem :

Step 1. Operational check out procedure (see section 1)

Step 2. Operational checks (see group 2)

Step 3. Troubleshooting

Step 4. Tests and adjustments (see group 3)

Problem	Cause	Remedy
Noisy hydraulic pump	<p>Low oil supply or wrong viscosity</p> <p>Plugged or pinched suction line</p> <p>Air in oil</p> <p>Plugged suction strainer</p> <p>Loose or missing hydraulic line clamps</p> <p>Hydraulic lines in contact with frame</p> <p>Worn or damaged pump</p>	<p>Fill reservoir with recommended oil.</p> <p>Clean or replace line.</p> <p>Check for foamy oil. Tighten connections.</p> <p>Replace O-rings and or lines.</p> <p>Inspect and clean strainer in reservoir.</p> <p>Tighten or replace clamps.</p> <p>Inspect and repair.</p> <p>Do hydraulic pump performance check in group 2. Do hydraulic pump flow test in group 3.</p>
No or Slow hydraulic functions	<p>Failed or worn hydraulic pump</p> <p>Cold oil</p> <p>Slow engine speed</p> <p>Suction line air leak</p> <p>Low oil supply</p> <p>Wrong oil viscosity</p> <p>Oil leaking past cylinders or control valve</p> <p>Blocked or damaged line</p> <p>Faulty or misadjusted pilot oil supply unit</p> <p>Faulty pilot control valve(RCV)</p> <p>Binding loader control valve(MCV) spool</p> <p>Faulty flow amplifier</p>	<p>Do performance check.</p> <p>Warm oil up.</p> <p>Adjust engine speed control linkage.</p> <p>Check high idle speed.</p> <p>Check for foamy oil.</p> <p>Add recommended oil.</p> <p>Use recommended oil.</p> <p>Check cylinder drift in group 2.</p> <p>Inspect lines.</p> <p>Do pilot oil supply unit pressure test in group 3.</p> <p>Do pilot control valve(RCV) pressure test in group 3.</p> <p>Inspect valve.</p> <p>Check priority valve, orifice of flow amplifier specification</p>

Item	Cause	Remedy
No steering or hydraulic function	<p>Low oil level</p> <p>Failed hydraulic pump</p> <p>Failed main hydraulic pump drive</p>	<p>Add recommended oil.</p> <p>Remove and inspect return filter for metal pump particles.</p> <p>Remove main hydraulic pump and inspect drive gear.</p>
No hydraulic functions steering normal	<p>Failed hydraulic pump</p> <p>Failed line filter</p> <p>Faulty safety valve</p> <p>Stuck open port relief valve</p>	<p>Remove and inspect return filter for metal pump particles, or replace the pump.</p> <p>Remove and inspect line filter for RCV.</p> <p>Safety valve leakage test or ON, OFF function test.</p> <p>Replace relief valve.</p>
Boom float function does not work	<p>Low pilot control pressure</p> <p>Faulty pilot control valve(RCV)</p> <p>Loader control valve(MCV) spool binding in bore</p>	<p>Do pressure reducing valve pressure test in group 3.</p> <p>Replace relief valve.</p> <p>Do pressure reducing valve pressure test in group 3.</p>
One hydraulic function does not work.	<p>Faulty pilot control valve(RCV)</p> <p>Stuck open port relief valve</p> <p>Oil leaking past cylinder packings</p> <p>Blockage in oil lines or valve</p> <p>Loader control valve(MCV) spool stuck in bore</p>	<p>Do pilot control valve pressure test. Inspect and repair valve.</p> <p>Replace relief valve.</p> <p>Do boom and bucket cylinder leakage test in group 3.</p> <p>Inspect lines for damage. Disconnect and inspect lines for internal blockage.</p> <p>Inspect and repair valve.</p>
Low hydraulic power	<p>Leakage within work circuit</p> <p>Low system relief valve(main relief valve) setting</p> <p>Low port relief valve setting</p> <p>Faulty or misadjusted pilot oil supply unit</p> <p>Leaking system relief valve</p> <p>Worn hydraulic pump</p> <p>Faulty pilot control valve</p>	<p>Do cylinder drift check in group 2.</p> <p>Do loader system and port relief valve pressure test in group 3.</p> <p>Do loader system and port relief valve pressure test in group 3.</p> <p>Do pilot oil supply unit pressure test in group 3.</p> <p>Remove and inspect valve.</p> <p>Do hydraulic pump performance check in group 2.</p> <p>Do pilot control valve pressure test in group 3.</p>

Item	Cause	Remedy
Function drifts down	Leaking cylinders Leaking seals in circuit relief valve(port relief valve) or valve stuck open Leaking loader control valve	Do cylinder leakage checks in group 2. Inspect seals. Replace relief valve. Repair or replace valve section.
Boom drifts up	Leakage in boom down spool	Remove and inspect boom down spool.
Boom down does not work(Engine off)	Safety valve not operated Stuck pilot control valve Faulty line filter Accumulation not operated. MCV spool stuck	Operate valve. Inspect. Remove and inspect filter. Inspect. Inspect and repair valve.
Oil overheats	Low oil viscosity in hot weather Excessive load Holding hydraulic system over relief Leakage in work circuit Plugged fins in oil cooler Internally plugged oil cooler Incorrect system or circuit relief valve setting Restriction in oil lines or loader valve(MCV) Pinched or restricted priority valve of flow amplifier "LS" line Malfunctioning flow amplifier Leaking system main relief valve Worn hydraulic pump(internal leakage)	Use recommended oil. Reduce load. Reduce load. Do boom and bucket cylinder leakage test in group 3. Inspect and clean oil cooler. Do hydraulic oil cooler restriction test in group 3. Do loader system and circuit relief valve pressure test in group 3. Inspect for dented or kinked lines. Do hydraulic system restriction test in group 3. Run engine at low idle. Steer machine back and forth. If engine load decreases while steering, a restricted "LS" line or priority valve of flow amplifier malfunction is indicated. Do priority valve of flow amplifier "LS" port flow test in group 3. Do hydraulic system restriction test in group 3. Remove and inspect valve and seals. Do hydraulic pump performance check in group 2.
Function drops before raising when valve is activated	Stuck open lift check valve	Do control valve lift check in group 2.

Problem	Cause	Remedy
Hydraulic oil foams	Low oil level Wrong oil Water in oil Loose or faulty suction lines (air leak in system)	Add recommended oil. Change to recommended oil. Change oil. Tighten or install new lines.
Remote control valve (RCV) leaking	Leaking plunger seals	Remove, inspect and replace plunger seals.

※ **Followings are general precautions for the hydraulic system and equipment.**

- 1) Every structure has its limit of strength and durability. The relief valve is installed to limit the pressure on the hydraulic equipment and protect various parts of the wheel loader from possible damage. Therefore, never change the preset pressure of the relief valve unless absolutely necessary.
- 2) Since the hydraulic equipment is built with precision, the presence of only the slightest amount of dust and / or other particles in the hydraulic circuit might cause wear and/or damage, resulting in unstable functions and/or damage, resulting in unstable functions and/or unexpected accidents. Therefore, always keep hydraulic oil clean. Periodically, check the filter in the return circuit and replace the element as necessary.
- 3) Extract about 200cc of hydraulic oil from the tank as a sample every 6 months. If possible, have it analyzed by a specialist to confirm that the oil can still be used. Never extract the oil for sampling until the oil temperature has become the normal operating temperature. Since the replacement period varies depending on operating conditions, refer to **Operator's Manual** and change oil.
- 4) Should the equipment get damaged due to the presence of metal particles and/or foreign matter in the circuit drain out the hydraulic oil and carry out flushing. Also, replace the filter element and clean the hydraulic tank. Change the hydraulic oil entirely.
- 5) When checking the filter, if found metal particles in the element, drain out the hydraulic oil entirely, flush the whole circuit, and then fill with new oil. The presence of metal particles may indicate internal damage to the equipment. In such a case, check carefully before flushing, and repair or replace as required.
- 6) To add and/or change the hydraulic oil, always use recommended oil.(Refer to the list of recommended oils and lubricants at page 1-22, **Recommended lubricants**.) Never mix oil of different makes of kinds.
- 7) To change the hydraulic oil, use a clean vessel and funnel for pouring it into the tank. Never use cloth because it might cause the presence of lint in the circuit.
- 8) When removing the hydraulic equipment, be sure to put plugs or caps on hoses, tube lines and ports. Also, enter mating marks for later identification.

- 9) Disassemble and/or assemble the hydraulic equipment only in a clean place free of dust. When disassembling, be careful about the interchangeability of parts, and clean the disassembled parts with pure and clean mineral cleansing oil. Clean the internal passages as well. After the parts have dried, wipe them off with a clean lint-free cloth.
- 10) When overhauling the hydraulic equipment replace all O-rings, backup rings, etc. with new ones. Assemble O-rings with grease or vaseline applied.
- 11) After installing the equipment, add more hydraulic oil to make up for that lost during disassembly.
- 12) Tighten joints correctly. Loose joints will cause the hydraulic oil to leak. If the oil leaks, the tank oil level drops and air gets sucked in, so the pump will break down. Also loose joints in suction lines will take air in and might cause abnormal noise, malfunction or damage to pumps.