

GROUP 2 ENGINE SPEED & STALL RPM

1. TEST CONDITION

- 1) Normal temperature of the whole system
 - Coolant : Approx 80 °C (176 °F)
 - Hydraulic oil : 45 ± 5 °C (113 ± 10 °F)
 - Transmission oil : 75 ± 5 °C (167 ± 10 °F)
- 2) Normal operating pressure : See page 6-53.

2. SPECIFICATION

Engine speed, rpm					Remark
Low idle	High idle	Pump stall	Converter stall	Full stall	
800±25	2200±50	1930±70	2030±70	1620±100	

3. ENGINE RPM CHECK

Remark : If the checked data is not normal, it indicates that the related system is not working properly. Therefore, it is required to check the related system pressure : See page 6-53.

1) Pump stall rpm

- Start the engine and raise the bucket approx 45cm (1.5ft) as the figure.
- Press the accelerator pedal fully and operate the bucket control lever to the retract position fully.
- Check the engine rpm at the above condition.

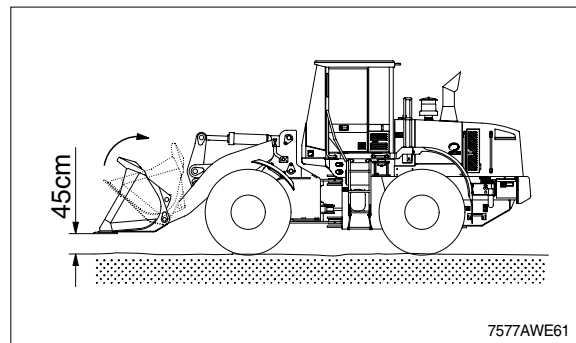

2) Converter stall rpm

- Start the engine and lower the bucket on the ground as the figure.
- Set the clutch cut off switch at the released position.
- Press the brake pedal and accelerator pedal fully.
- Shift the transmission lever to the 4th forward position.
- Check the engine rpm at the above condition.

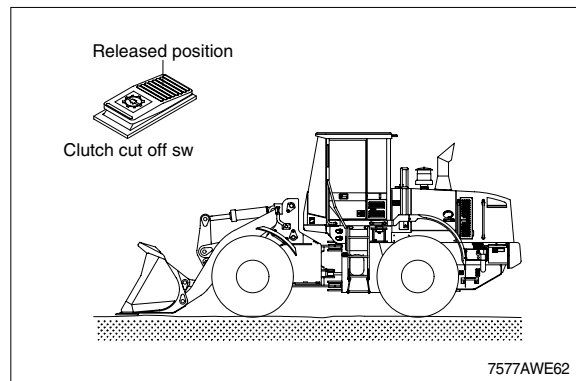

3) Full stall rpm

- Start the engine and raise the bucket approx 45 cm (1.5 ft) as the figure.
- Set the clutch cut off switch at the released position.
- Press the brake pedal and accelerator pedal fully .
- Shift the transmission lever to the 4th forward position and operate the bucket lever to the retract position fully.
- Check the engine rpm at the above condition.

