

GROUP 3 MONITORING SYSTEM

1. CLUSTER

1) STRUCTURE

The cluster consists of gauges, lamps and LCD as shown below, to warn the operator in case of abnormal machine operation or conditions for the appropriate operation and inspection.

- Gauges : Indicate operating status of the machine.
- Warning lamps : Indicate abnormality of the machine.
- Pilot lamps : Indicate operating status of the machine.
- LCD : Indicates selected the driving speed and direction.

※ The cluster installed on this machine does not entirely guarantee the condition of the machine. Daily inspection should be performed according to chapter 6, MAINTENANCE.

※ When the cluster provides a warning immediately check the problem, and perform the required action.

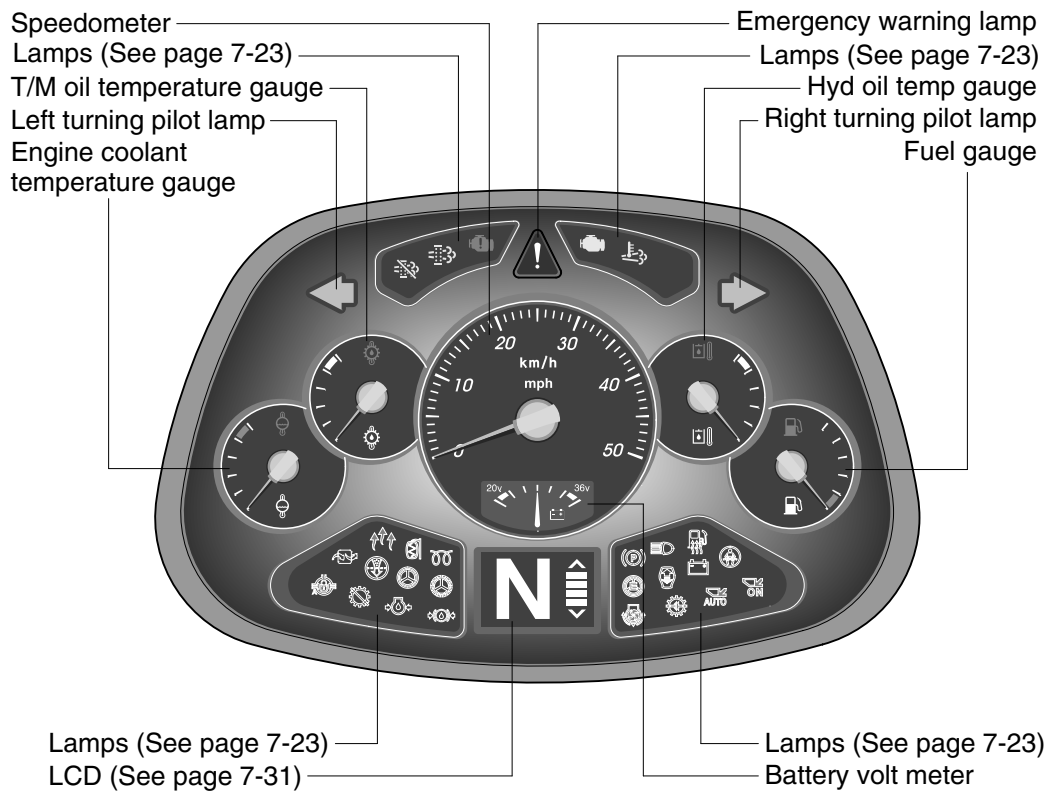

7609A7EL15

2) GAUGE

(1) Speedometer

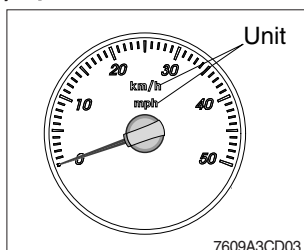

① The speedometer displays the speed of machine in mph and km/h.

- ※ The unit (km/h or mph) can be set by the display set up menu of the monitor and selected unit is displayed. Refer to page 7-50.

(2) Fuel gauge

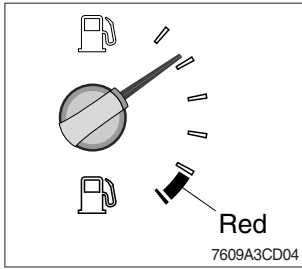

- ① This gauge indicates the amount of fuel in the fuel tank.
 - ② Fill the fuel when the indicator moves red range or  lamp blinks in red, refuel as soon as possible to avoid running out of fuel.
- ※ If the gauge indicates below red range even though the machine is on the normal condition, check the electric device as that can be caused by the poor connection of electricity or sensor.

(3) Engine coolant temperature gauge

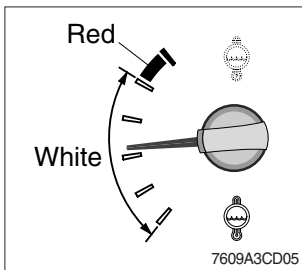

- ① This gauge indicates the temperature of coolant.
 - White range : 40~104°C (104~219°F)
 - Red range : Above 104°C (219°F)
- ② If the indicator is in the red range or  lamp blinks in red, turn OFF the engine and check the radiator and engine.

(4) Transmission oil temperature gauge

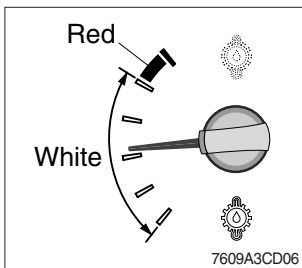

- ① This gauge indicates the temperature of transmission oil.
 - White range : 40~107°C (104~225°F)
 - Red range : Above 107°C (225°F)
- ② If the indicator is in the red range or  lamp blinks in red, it means the transmission is overheated. Be careful that the indicator does not move into the red range.

(5) Hyd oil temperature gauge

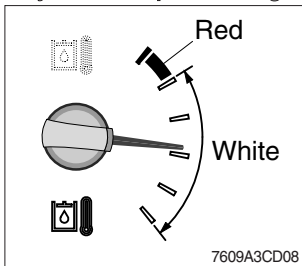

- ① This gauge indicates the temperature of hydraulic oil.
 - White range : 40~105°C (104~221°F)
 - Red range : Above 105°C (221°F)
- ② If the indicator is in the red range or  lamp blinks in red, reduce the load on the system.
- ③ If the gauge stays in the red range, stop the machine and check the cause of the problem.

(6) Battery volt meter

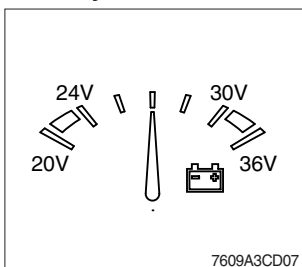

- ① This gauge indicates the voltage in the charging system when the engine is running.
- ② If the indicator is below 24V, it means that the electricity is being discharged. If the indicator is above 30V, an unusually high voltage may damage the alternator. Check the charging system in both cases.

3) WARNING LAMPS

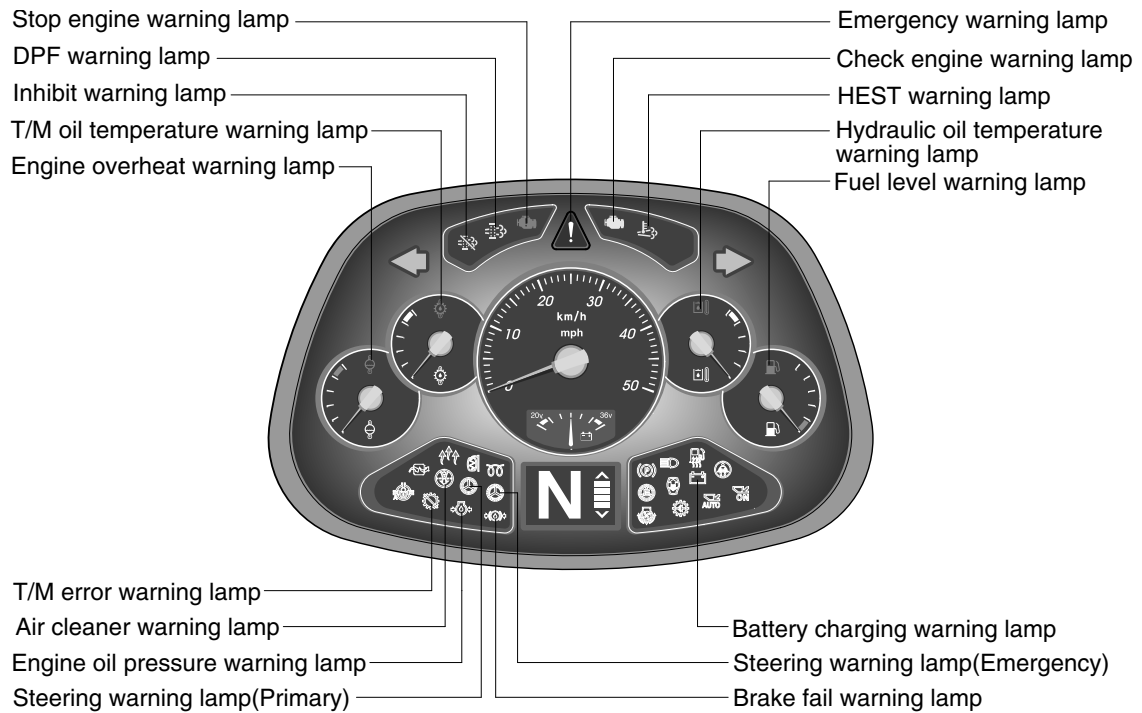

7609A3CD09

(1) Emergency warning lamp



- ① This warning lamp blinks and the buzzer sounds when communication error occur between monitor and MCU.
- ② When this warning lamp blinks, machine must be checked and service immediately.

(2) Engine overheat warning lamp

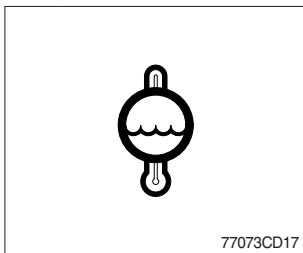

- ① This lamp is turned ON when the temperature of coolant is over the normal temperature (106°C, 223°F).
- ② Check the cooling system when the lamp is ON.

(3) Transmission oil temperature warning lamp

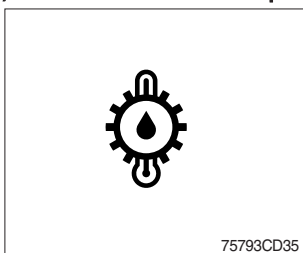

- ① This lamp informs the operator that transmission oil is above the specified temperature.
- ② When this lamp lights up during operation, stop the engine and check the machine.

(4) Hydraulic oil temperature warning lamp

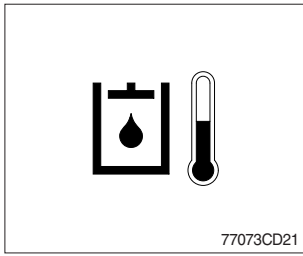

- ① This warning lamp operates and the buzzer sounds when the temperature of hydraulic oil is over 105°C (221°F).
- ② Check the hydraulic oil level when the lamp is turned ON.
- ③ Check for debris between oil cooler and radiator.

(5) Fuel level warning lamp

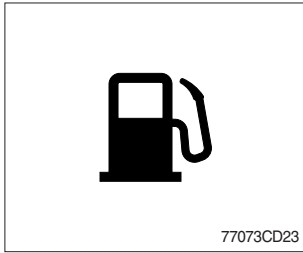

- ① This warning lamp lights ON when the fuel level is low. Refuel the machine as soon as possible.

(6) Transmission error warning lamp

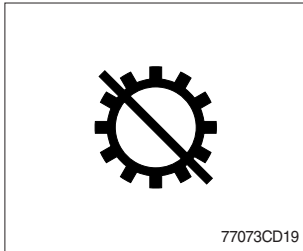

- ① This lamp lights ON and the LCD display show the error codes when an error occurs in the transmission.
 - ② Immediately pull the machine to a convenient stop. Stop the engine. Investigate the cause.
- ※ Consult a HYUNDAI dealer to investigate the cause.
※ Do not operate until the cause has been corrected.

(7) Air cleaner warning lamp

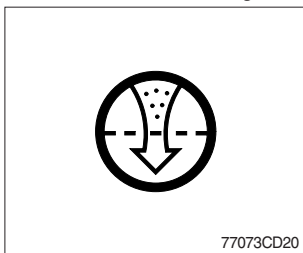

- ① This lamp lights ON when the filter of air cleaner is clogged.
- ② Check the filter and clean or replace it when the lamp is ON.

(8) Engine oil pressure warning lamp

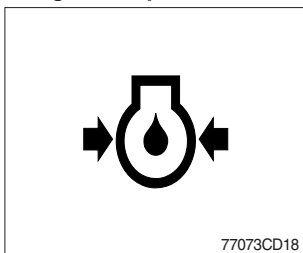

- ① This lamp is comes ON after starting the engine because of the low engine oil pressure.
- ② If the lamp comes ON during engine operation, shut OFF engine immediately. Check engine oil level.

(9) Steering warning lamp

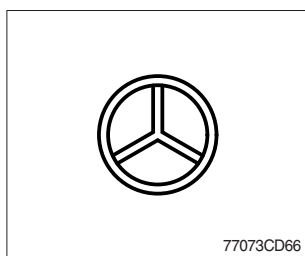

① Primary

This lamp indicates that the primary steering has failed. When the indicator comes on and the action alarm sounds, steer the machine immediately to a convenient location and stop the machine. Stop the engine and investigate the cause.

※ **Do not operate the machine until the cause has been corrected.**

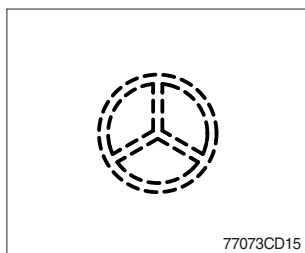

② Emergency

This lamp indicates the emergency steering system is active.

※ **Immediately pull the machine to a convenient stop and stop the engine.**

※ **The emergency steering system can be manually tested. Refer to page 7-56.**

(10) Battery charging warning lamp

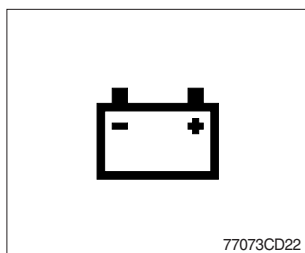

① This lamp is ON when key ON, it is turned OFF after starting the engine.

② Check the battery charging circuit when this lamp comes ON, during engine operation.

(11) Brake fail warning lamp

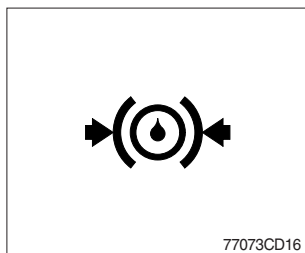

① The lamp lights ON when the oil pressure of service brake drops below the normal range.

② When the lamp is ON, stop the engine and check for its cause.

※ **Do not operate until any problems are corrected.**

(12) Check engine warning lamp

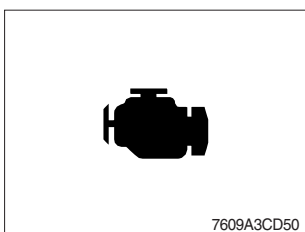

① This lamp lights ON when the communication between MCU and engine ECM on the engine is abnormal, or if the cluster received any fault code from engine ECM.

② Check the communication line between them.

If the communication line is OK, then check the fault codes on the cluster.

③ Also, this lamp lights ON when the level of DPF soot is high.

(13) Stop engine warning lamp

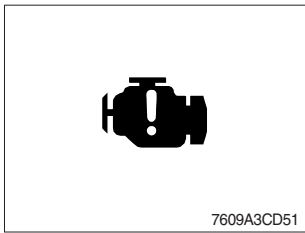

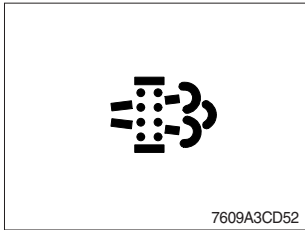

- ① If the lamp lights ON, stop the engine immediately and check the engine.
- ② Check the fault codes on the monitor.
- ※ **Please contact your Hyundai service center or local dealer.**

(14) DPF (Diesel particulate filter) warning lamp



- ① This warning lamp lights ON or blinks when the regeneration is needed as table below.
- ※ **Consequences of delaying regeneration**
 - Poor performance caused by increasing exhaust gas pressure.
 - Higher fuel consumption
 - Shorter filter lifetime

Condition	Warning lamp			Remedy
	DPF 	Check engine 	Stop engine 	
Normal	Off	Off	Off	· Automatic regeneration
Soot low	On	Off	Off	· Increase engine load/speed and allow engine to run until regeneration is completed (DPF lamp : OFF)
Soot medium	Blink	Off	Off	· Initiate a manual regeneration as following page · Engine power may be slightly reduced automatically (soot medium)
Soot high	Blink	On	Off	· Initiate a manual regeneration · Engine power and speed will be reduced automatically
Stop	Off	Off	On	· Stop the engine immediately. · Please contact your Hyundai service center or local dealer.

※ Manual regeneration method of DPF

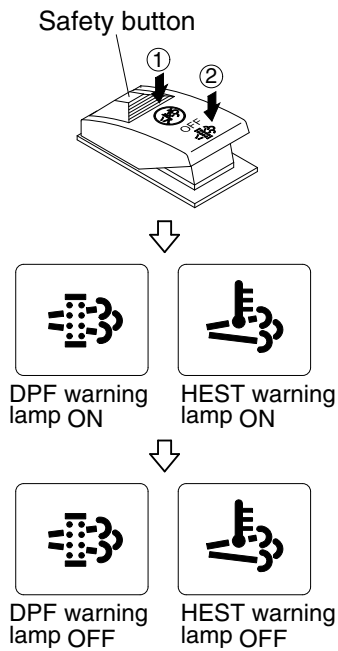

2609A3CD143

※ Manual regeneration applies if the machine is in a fireproof area and there is no plan to turn off the machine during the regeneration.

① Stop and park the machine.

② Pull the safety button and push the switch to position ② to initiate the manual regeneration of DPF.

※ Refer to the page 7-58 for the switch operation.

※ The engine speed may increase to 950~1050 rpm and DPF regeneration begins and it will take approximately 20~30 minutes.

③ The DPF and HEST warning lamp will light ON during the regeneration function is operating.

④ The DPF and/or HEST warning lamp will light OFF when the regeneration function is completed.

(15) HEST (High exhaust system temperature) warning lamp

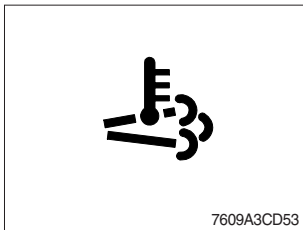

① This warning lamp indicates, when illuminated, that exhaust temperatures are high due to regeneration of the DPF.

② The lamp will also illuminate during a manual regeneration.

③ When this lamp is illuminated, be sure the exhaust pipe outlet is not directed at any surface or material that can melt, burn, or explode.

⚠ When this lamp is illuminated, the exhaust gas temperature could reach 800°C [1500°F], which is hot enough to ignite or melt common materials, and to burn people.

※ The lamp does not signify the need for any kind of equipment or engine service; It merely alerts the equipment operator to high exhaust temperatures. It will be common for the lamp to illuminate on and off during normal equipment operation as the engine completes regeneration.

(16) DPF regeneration inhibit warning lamp

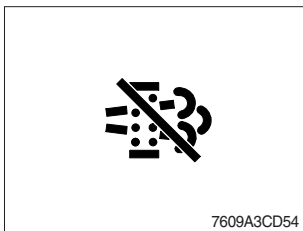

① This warning lamp indicates, when illuminated, the DPF switch is pushed inhibit position, therefore automatic and manual regeneration can not occur.

※ Refer to the page 7-58 for the DPF switch.

4) PILOT LAMPS

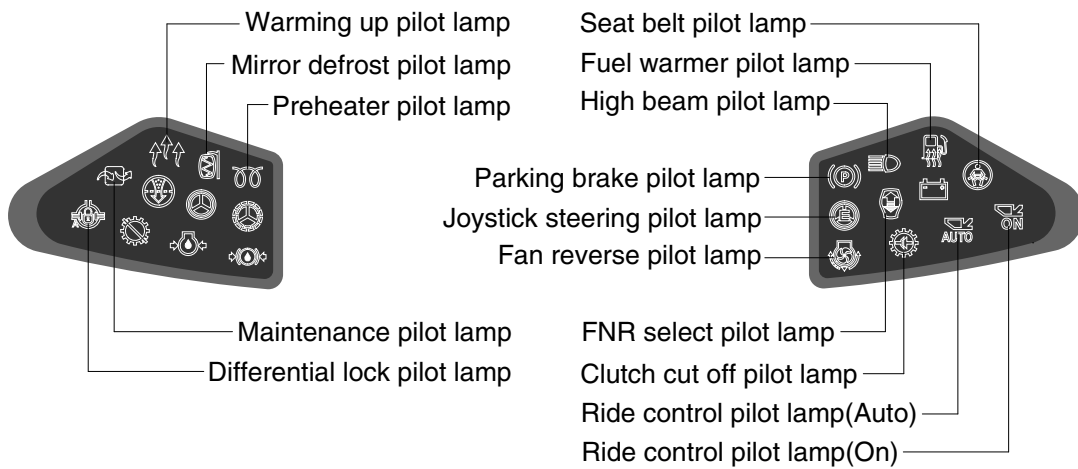

7609A3CD10

(1) Warming up pilot lamp

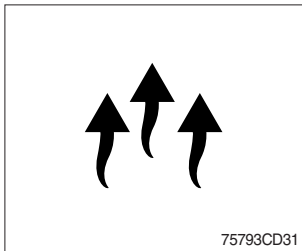

- ① This lamp is turned ON when the coolant temperature is below 30°C (86°F).
 - ② The automatic warming up is cancelled when the engine coolant temperature is above 60°C, or when 10 minutes have passed since starting the engine.
 - ※ Automatic warming up condition
 - Gear selector is in neutral position.
 - Parking brake is applied.
- Refer to page 7-36.

(2) Seat belt pilot lamp

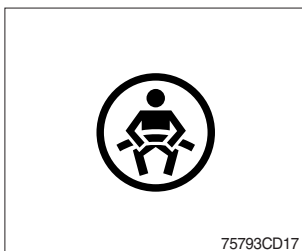

- ① This lamp lights ON for the first five seconds after starting the engine.

(3) Mirror defrost pilot lamp

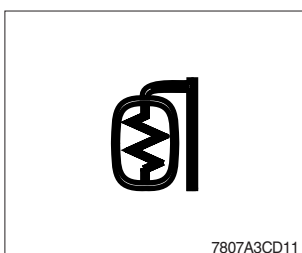

- ① This lamp comes ON when mirror defrost switch is pressed.
- ※ Refer to page 7-55 for details.

(4) High beam pilot lamp

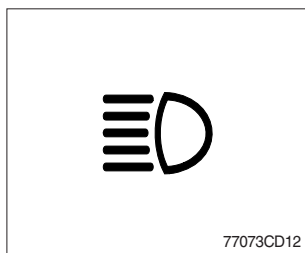

- ① This lamp works when the illuminating direction is upward.
- ② This lamp comes ON when the dimmer switch is operated, e.g., when passing another vehicle.

(5) Preheat pilot lamp

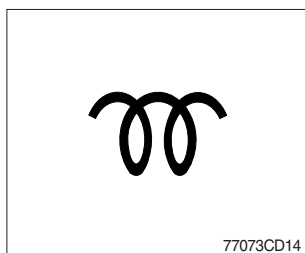

- ① This lamp lights ON when start switch is turned clockwise to the ON position. Light will turn off after approximately 5~45 seconds, depending on engine temperature, indicating that preheating is completed.
- ② When the lamp goes out the operator should start cranking the engine.

(6) Parking brake pilot lamp

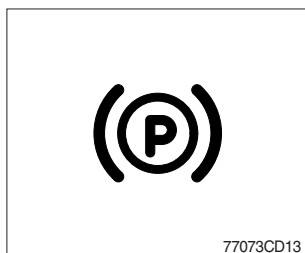

- ① When the parking brake is actuated, the lamp lights ON.
- ※ Check the lamp is OFF before driving.

(7) Maintenance pilot lamp

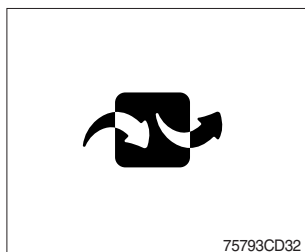

- ① This lamp will be ON when the consuming parts are needed to change or replace. It means that the change or replacement interval of the consuming parts remains below 30 hours.
- ② Check the message in maintenance information of the monitor menu. Also, this lamp lights ON for 3 minutes when the start switch is ON position.

(8) Clutch cut off pilot lamp

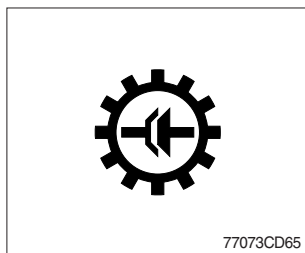

- ① This lamp lights ON when clutch cut off mode switch is positioned L, M, H.
- ※ Refer to page 7-58.

(9) FNR select pilot lamp (option)

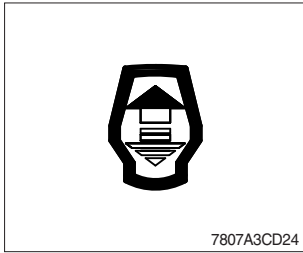

- ① The lamp comes ON when FNR select button on the optional FNR remote control lever is pressed.
- ※ Refer to page 3-43 of the operator's manual.

(10) Joystick steering pilot lamp (option)

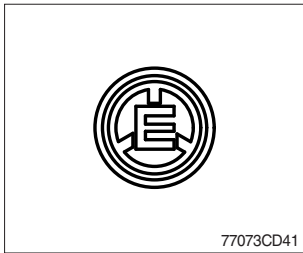

- ① This lamp lights ON when joystick steering is activated. It is then possible to steer the machine and select gears from the armrest to the left of the operator's seat.

(11) Ride control pilot lamp (option)

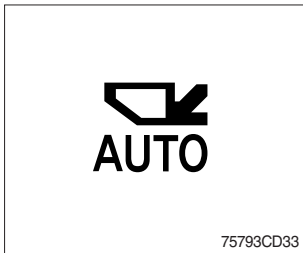

- ① **Auto ride control**
This lamp lights ON when push in the bottom of the ride control switch (auto position).
- ※ Refer to page 7-56.

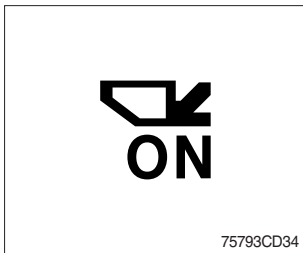

- ② **Manual ride control**
This lamp lights ON when push in the top of the ride control switch (manual position)
- ※ Refer to page 7-56.

(12) Fan reverse pilot lamp

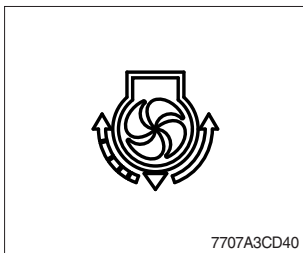

- ① This lamp lights ON when the fan control switch is pressed.
- ※ Refer to page 7-55.

(13) Differential lock pilot lamp (option)

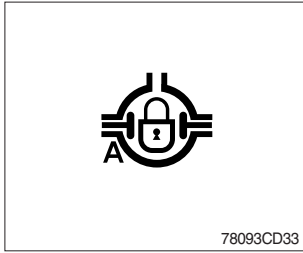

- ① This lamp lights ON when the differential lock function is operating.
- ※ Refer to page 7-57.

(14) Fuel warmer pilot lamp

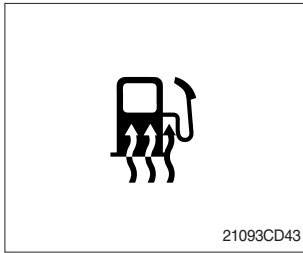

- ① This lamp is turned ON when the coolant temperature is below 10°C (50°F) or the hydraulic oil temperature 20°C (68°F).
- ② The automatic fuel warming is cancelled when the engine coolant temperature is above 60°C and the hydraulic oil temperature is above 45°C since the start switch was ON position.

5) LCD

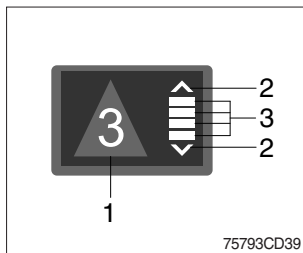

- (1) The LCD can be used with the gear selector.
It indicates speed and driving direction.

No	Symbol	Meaning	Remark
1	△, ▽, □	Actual gear display	Forward, reverse, neutral
	1, 2, 3, 4, 5		Actual gear
	P		Parking brake mode active
2	▲, ▼	Forward, reverse	Automatic mode
3	▬, ▬, ▬	Gear range display	Automatic mode

2. MONITOR

- The monitor is adjustable.
 - Vertical : 14°
 - Horizontal : 30°



7609A3CD23

1) BUTTONS

(1) Menu button



- ① Main display to main menu, main menu to main display.
- ② AEB cancel or finish button in AEB.

(2) Left move button



- ① Move in menu (left, up).
- ② Decrease input value.

(3) Camera / ESC button



- ① Enter rear camera mode in main display.
- ② For other menu, this is used for cancellation (move to previous menu).
- ③ AEB cancel or finish button in AEB.

(4) Right move / Buzzer stop button



- ① Move in menu (right, down).
- ② Stop buzzer sound when sound is on.
- ③ Increase input value.

(5) Enter button



- ① Select menu (enter).
- ② AEB cancel or finish button in AEB.

2) MAIN MENU

- ※ You can select or set the menu by the select switch or touch screen.
- ※ Please refer to button, page 7-32 for selection and change of menu and input value.
- ※ Display type can be changed by operator. See page 7-50.

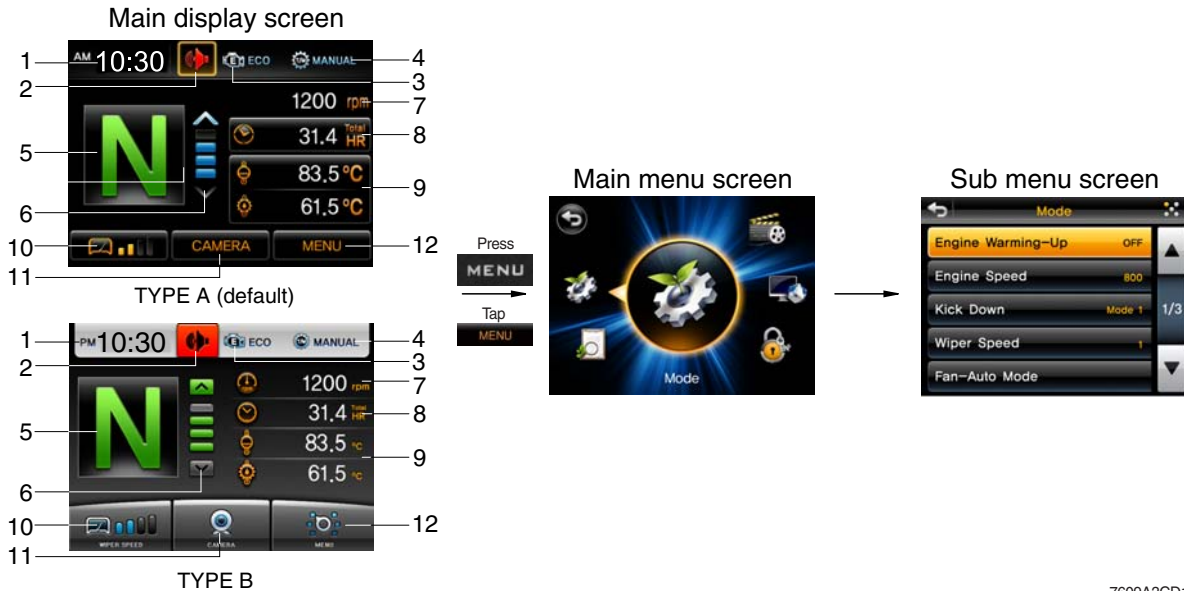

7609A3CD11

- | | | |
|---------------------|------------------------|----------------------|
| 1 Clock | 5 Actual gear | 9 Machine monitoring |
| 2 Buzzer | 6 Select gear | 10 Wiper speed |
| 3 Engine mode | 7 Engine rpm | 11 Camera screen |
| 4 Transmission mode | 8 Hour meter, odometer | 12 Menu |

(1) Pop up and stop buzzer sound

- ① In main display, you can check the data and setup what you want by touching wiper speed, hour/ODO meter and monitoring window area.
- ② Pop up window will be closed in 3 seconds after touching the window or by pressing outside area of popup window.

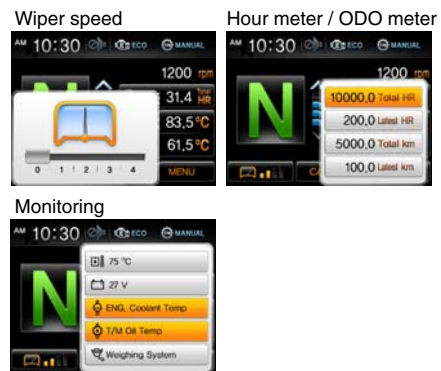

7609A3CD55

- ③ When the buzzer sound is ON, the red icon will be activated. If you want to stop buzzer sound, just touch the icon.



7609A3CD59

(2) Warning

- ① Warning sign will be shown when the temperature of hydraulic oil, cooling water and transmission oil is not normal state (red icon will be shown at center of display and then move to assigned area).
- ② Case of warning sign
 - Above 105°C of hydraulic oil temperature
 - Above 104°C of cooling water temperature
 - Above 107°C of T/M oil temperature



7609A3M56





(3) Communication error

- ① MCU could not communicate with monitor over 10 seconds, error message will be show on the screen.



7609A3M57

3) MAIN & SUB MENU STRUCTURE

No	Main menu	Sub menu	Description
1	 <p>Mode</p> <p>7609A3CD12</p>	Engine warming up Engine speed Kick down Wiper speed Fan-auto mode AEB Speed meter setting Boom/bucket angle Boom pressure Brake pedal sensor calibration	Engine warming up Engine speed Mode 1 (down/up), Mode 2 (down only) 4 steps Interval and time setting AEB setting Pulse setting Boom/bucket angle calibration Boom pressure calibration Brake pedal sensor calibration
2	 <p>Monitoring</p> <p>7609A3CD13</p>	Fault code Machine monitoring Monitoring history	Active /logged fault (machine, ECU, TCU, SCU) Hyd temp, Battery, Engine coolant temp T/M oil temp, Weighing system Hour meter, ODO meter
3	 <p>Management</p> <p>7609A3CD14</p>	ESL system setting Maintenance Machine information Service contact Touch calibration Service menu	Machine security, Change password, Manage the smart key usage Replacement, Change cycle (oils and filters) Version, Machine information Check and change of contact information Calibrating the touch screen S/W update, Manage the smart key tag
4	 <p>Display set up</p> <p>7609A3CD15</p>	Clock Brightness setting Display type Unit Rear camera Language	Clock Brightness setting (Manual/Automatic/Day time set) Type A, Type B Temp (°F/°C), Speed (km/h,mph), Weight (ton, lb), Pressure (bar, Mpa, kgf/m², psi) Reverse mode, Active camera, Display order 12 languages
5	 <p>Multimedia</p> <p>7609A3CD16</p>	Audio player Video player	Play MP3, OGG, WMV Play AVI, WMV

(1) Function of sub menu icons

1 Previous step button (same as ESC function)

- Move to previous screen.
- Close pop up screen.

2 Scroll

- Display present page/total page.
- Move to page by using up / down arrow button.

3 Move to main menu

- Main menu icon is shown at the below of screen.
- You can choose the main menu directly.



7609A3CD30/31

(2) Mode

① Engine warming up



- Setting engine warming-up ON/OFF

※ If the starting switch is OFF, engine warming up setting will automatically reset to OFF.

② Engine speed



- Setting engine low idle rpm

③ Kick down



- Mode 1 (down/up) : Press kick down switch once, shift down and press switch again, shift up.
- Mode 2 (down only) : Press kick down switch every time, shift to lower gear respectively.

※ Refer to page 7-60.

④ Wiper speed



- Setting wipe speed 1 to 4.

⑤ Fan-auto mode



- In auto position, select reverse interval or reverse time.
- Set reverse interval (30~300 min) or reverse time (30~300 sec).

※ Default : Interval (60 min), time (120 sec)





※ Refer to page 7-55, fan control switch.

※ Using button

- To change the value, press ◀ or ▶/⏏ .
- To change the position (hour, minute), press ⌚.

⑥ AEB





- AEB mode controls the disk clearance of the transmission, automatically.
- To start AEB setting, press AEB bar (or ) for 3 seconds.
- To cancel AEB setting, press **MENU**, /ESC or .
- If "OK" in actual gear window, press **MENU**, /ESC or  to complete AEB setting.
- **Display during AEB mode**

Symbol	Meaning
ST	Start AEB
K1~K4, KV, KR	Calibrating clutch K1~K4, KV or KR respectively
OK*	Calibration for all clutches finished
Spanner and Kx*	Kx couldn't be calibrated, AEB finished
△E	Engine speed too low - Raise engine speed
▽E	Engine speed too high - Lower engine speed
△T	Transmission oil temperature too low - Heat up transmission
▽T	Transmission oil temperature too high - Cool down transmission
FO*	Output speed not zero
FN*	Shift lever not in neutral position
FP*	Parking brake not applied

* : Transmission stays in neutral, you have to restart the TCU (starting switch off/on).

⑦ Speed meter setting



- Press speed meter setting bar (or ) for 3 seconds.
- ※ **Only for the service person. Do not adjust arbitrary.**
- ※ **Using button**
- To change the pulse value, press ◀ or ▶/※.
- To change the position, press .

⑧ Boom/bucket angle



7609A3M21



7609A3M21A

- Press NEXT button after following the instruction at each step.
- If correction is right, NEXT button will be activated, then go to next stage.
- After following each step correctly, the message "Calibration is done" will be shown. Press OK button, then process be ended.

※ Using button

- Using  instead of NEXT, OK button.



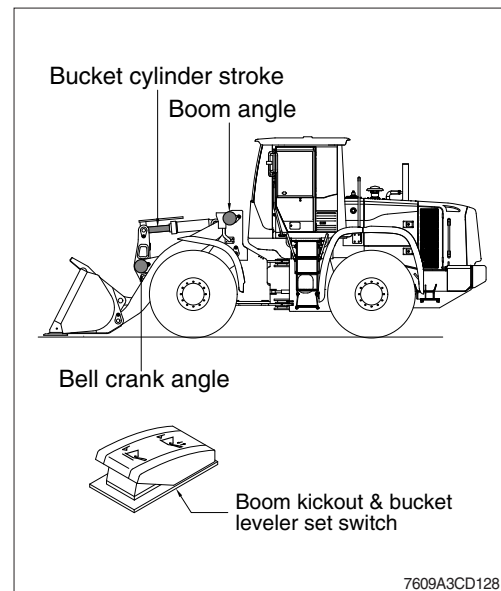

· Boom / Bucket angle calibration

- MCU get sensing signal from boom angle and bell crank angle and calculate bucket cylinder stroke and boom link position angle from ground real time basis.
 - Boom angle position and bucket cylinder stroke is set by boom kickout & bucket leveler set switch in cab.
 - Individual setting position is done by lever (detent, release operation).
 - Angle sensor calibration is basically carried out before delivery of the machine.
- When angle sensor is replaced or actual value is different compared to setting value, this function can be done.



7609A3CD128

- The calibration must be carried out as follows :

- ① Lower the boom at maximum low position and press NEXT button or  (bucket must be max tilting position).
- ② Raise boom at maximum high position and press NEXT button (or ).
- ③ Position boom at -5° and press NEXT button (or ).
- ④ Retract bucket cylinder length (to minimum position) at -5° boom position and press NEXT button (or ).
- ⑤ Extend bucket cylinder length (to maximum position) at -5° boom position and press NEXT button (or ).
- ⑥ In case above steps are carried normally, "Calibration is done" message is shown. Then angle sensor calibration is finished.

- ※ **Boom down / boom up / bucket position setting** : Refer to operator's manual, page 4-22.

⑨ Boom-pressure



7609A3M21C



7609A3M21D

Display A

- Press START button after following the instruction.
- After a few minutes, "Calibration fail" or "Calibration success" message will be shown. Press OK button then process be ended.

※ Using button

- Using instead of NEXT, confirm button.

· Boom pressure calibration

- It is used when bucket weight is changed or measured weight is inaccurate.
- The calibration must be carried out as follows :

- ① Increase hydraulic temperature (about 30~60°C).
- ② Select "Boom-pressure".
- ③ Roll-in the bucket at maximum range and lower the boom at minimum height.
- ④ Press START button.
- ⑤ Raise boom to maximum position. Boom up must be finished before stepping advance in "display A".
- ⑥ If it show "Calibration success" message in a moment, press OK button (or .

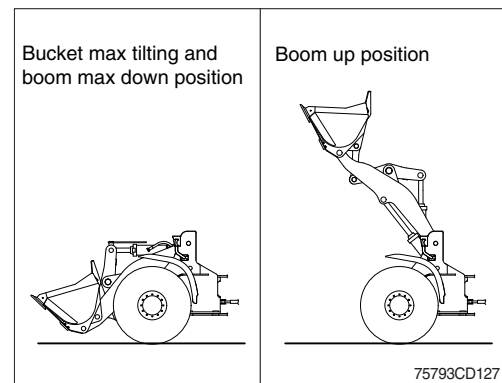

- ※ Raise hydraulic temperature enough when checking work load / boom pressure sensor calibration (recommendation : about 30 ~ 60°C).
- ※ Check if pressure sensor or angle sensor is in normal condition for accurate work load algorism or pressure sensor calibration [pressure sensors at boom cylinder head area and rod area, boom angle sensor (CD-80), bell crank angle sensor (CD-81)].
- ※ Sensor error message during pressure sensor calibration : sensor need to be checked.

⑩ Brake pedal sensor calibration

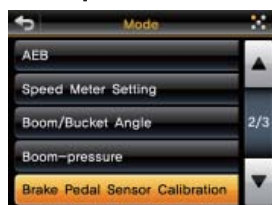

7609A3M21E



7609A3M21F

- Turn the engine OFF and turn the starting switch ON position.
- Press OK button, then calibration will be started.
- For cancel, press MENU button in main display.
- When it is finish (OK in actual gear window), press MENU button in main display.

※ Using button

- For cancel or finish, press **MENU**, /ESC or .

(3) Monitoring
 ① Fault code

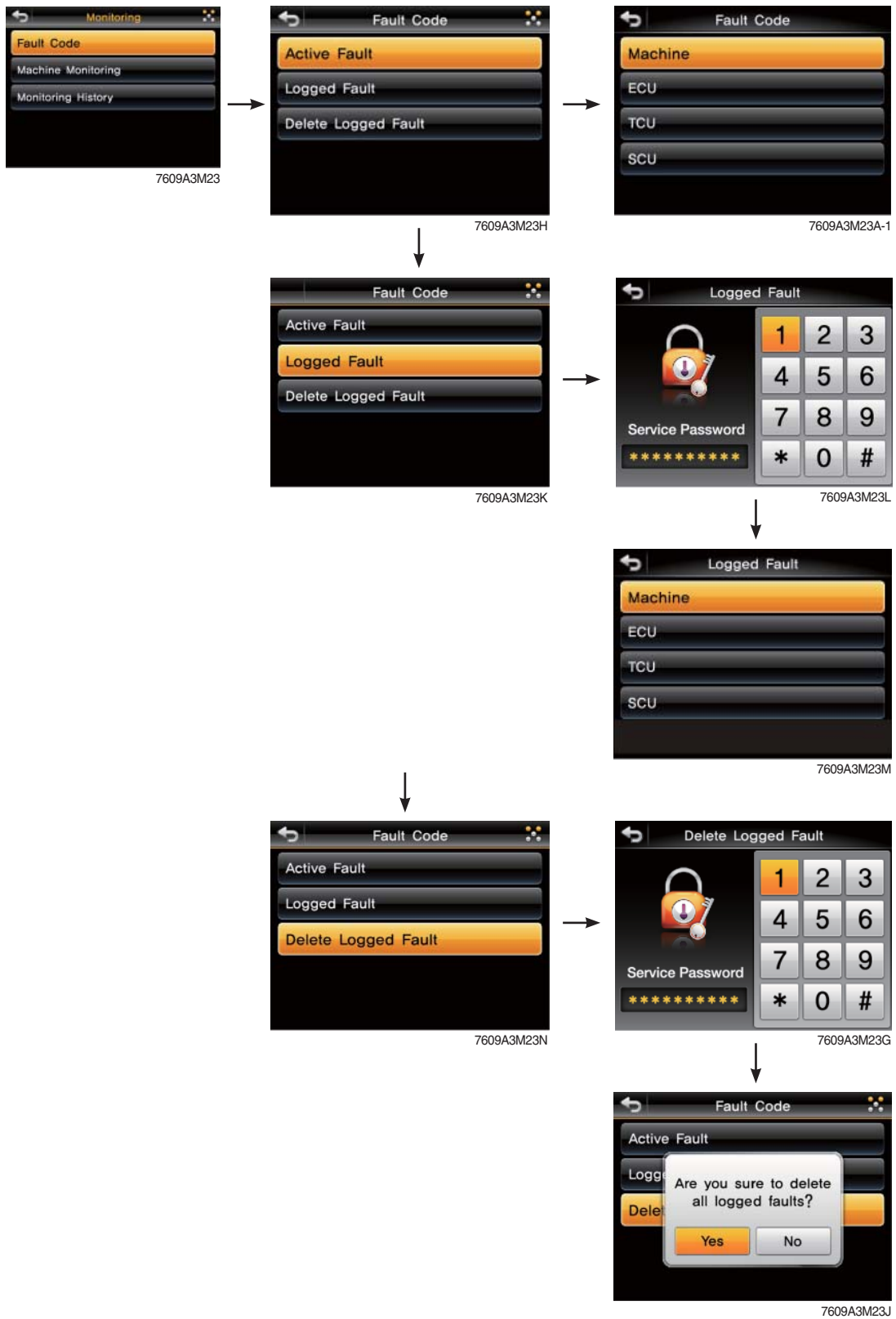

- Monitor the fault code of the Machine/ECU/TCU/SCU.
- ※ Not define will be indicated in case of that there's no fault.
- ※ SCU (opt) : Only for SCU (Steering Control Unit) equipped machine.

※ Weighing system

■ Principle

- The weight indication in bucket is calculated by measuring boom position and boom pressure.

(a) The weight is '0.0 ton' when the boom is placed at below -15°.

(b) The weight is indicated when the boom is placed at the range (-5°→15°).

(c) The weight is calculated when the boom is placed at above -5° and boom is lowered below -15° after dumping operation.

In order to recheck weight, go to the (b) after changing boom position (below -15°).

- Dump operation : It is checked by bucket cylinder's stroke change (below 250 mm).

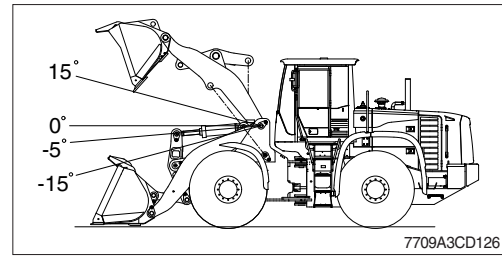

■ Monitor display

- When pressing work load switch less than 2 seconds, the weight is shown sequence basis. (main display 1 → 2 → 3 → 4 → 1)



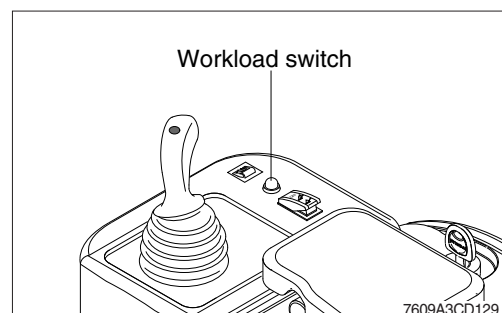

	Work weight (today)
	Work weight (previous day)
	Total weight accumulated in memory A, B, C individually regardless of date
	Current weight

- Default accumulated value at memory A, B, C when pressing work load switch more than 2 seconds (default : 0.0 ton).

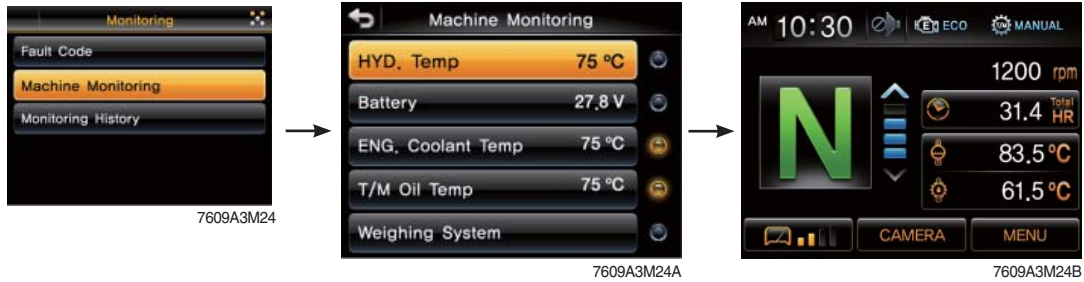

② Machine monitoring



- Monitor the status of the machine.
- To display the item in main display, select the item by touch bar (or )
- The right icon shows selected status (ON/OFF).

※ Priority in the main display



The example of the weighing system

- The priority of the weighing system is the highest.
- If the weighing system is selected, the other items are not available.
- To display the other items, the weighing system should not be selected.

※ **Weighing system** : see page 7-42.

③ Monitoring history



- **Hour meter / ODO meter**
- **Total**
 - Total working hour/total distance (this item cannot be initialized).
- **Latest**
 - Working hour/distance after reset.
 - If you select **Initializing**, working hour/distance start zero.
- To display the item in main display, select the item by touch bar (or )
- The right icon shows selected status (ON/OFF).

(4) Management

① ESL system setting

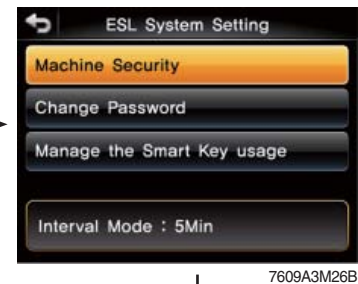

· Machine security

- ESL : Engine Starting Limit
- ESL mode is designed to be a theft deterrent or will prevent the unauthorized operation of the machine.
- If the ESL mode was selected Enable, the password will be required when the start switch is turned ON.
- Disable : Not used ESL function
- Enable : The password is required whenever the operator start engine.

Interval mode : The password is required when the operator start engine first. But the operator can restart the engine within the interval time without inputting the password.
The interval time can be set maximum 2 days.



· Interval time

- If set interval time to 5 minutes, ESL system is activated after 5 minutes.
- Therefore, the password does not need to restart engine within 5 minutes.

※ Default password : 00000 *

· Change password

- Input 5 to 10 digits and press *.



- **Manage to smart key usage (opt)**
 - Set the using or not of smart key.
 - If you using smart key, ESL function always be activated.



※ **Using smart key**

- Smart key icon (yellow) is on the screen.
- **Verification success**
Smart key icon color is changed to green, then changed to main display.
- **Verification failure**
Smart key icon color is changed to red, then changed to password input screen.



Verification success



Verification failure

② Maintenance

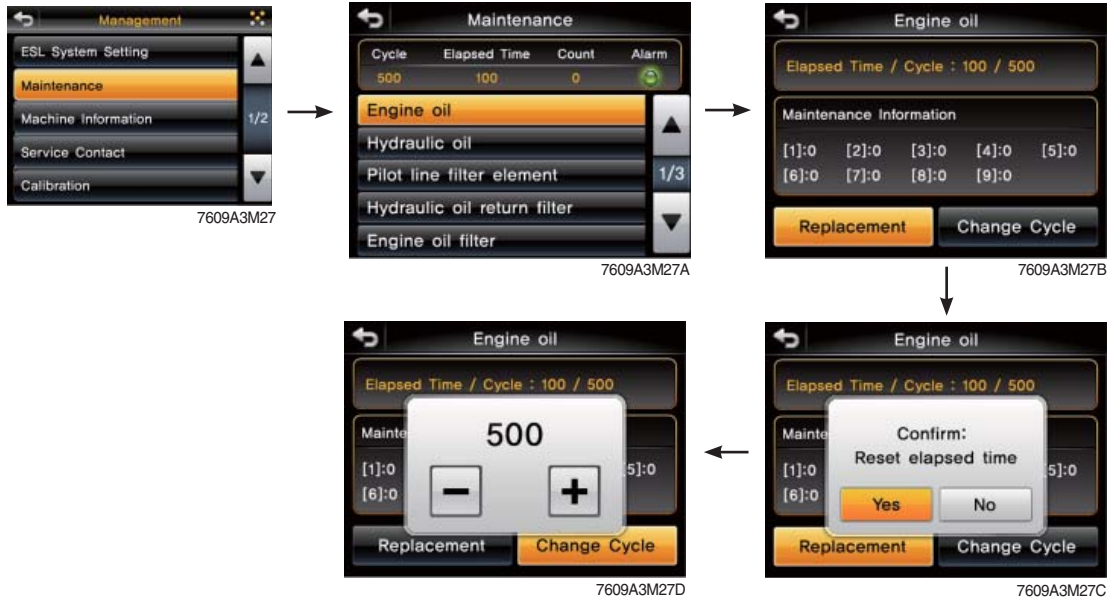

- Alarm : Warning
- Replacement : The elapsed time will be reset to zero.
- Change cycle : The change or replace cycle can be changed in the unit of 50 hours.
- To change cycle, press +/- button (◀ or ▶/OK).
- **Change or replace interval**

No	Item	Interval
1	Engine oil	500
2	Hydraulic oil	★ ¹ 2000 ★ ² 5000
3	Pilot line filter element	1000
4	Hydraulic oil return filter	1000
5	Engine oil filter	500
6	Fuel filter element	500
7	Fuel pre-filter	500
8	Hydraulic tank air breather	250
9	Radiator coolant	2000
10	Transmission oil and filter	1000
11	Axle oil (front and rear)	1500
12	Aircon & heater outer filter	1000
13	Air cleaner element (safety)	4000
14	Air cleaner element (primary)	4000
15	Crankcase ventilation filter	2000

★¹ : Conventional hydraulic oil

★² : Hyundai genuine long life hydraulic oil

③ Machine information

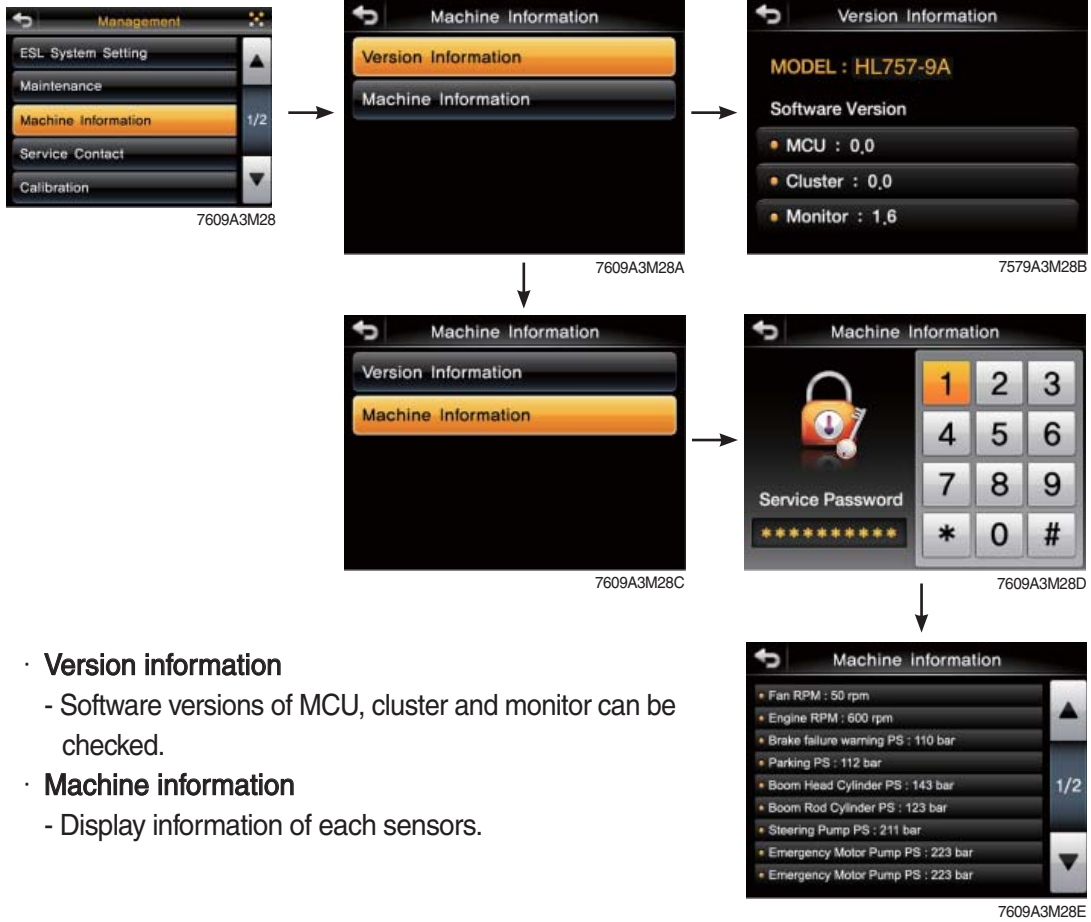

④ Service contact



⑤ Touch calibration



⑥ Service menu



7609A3M30



7609A3M30A

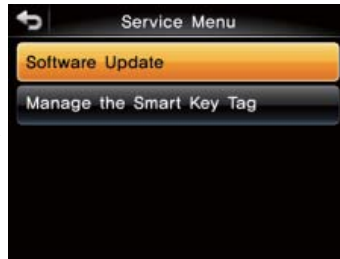

7609A3M30B

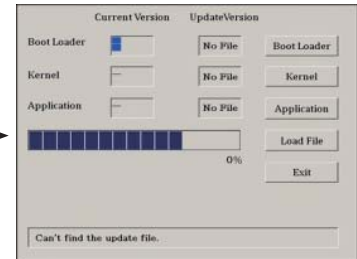

7609A3M30F

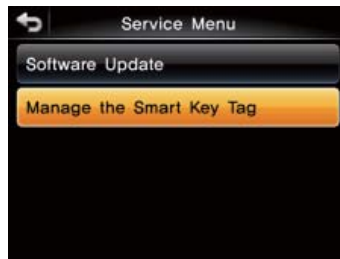

7609A3M30D



7609A3M30E

- **Software update**
 - Update file in USB memory.
- **Manage the smart key tag.**
 - Register or delete user tag.
 - When delete user tag, all user tag will be deleted.
 - Display the number of registered user tag.

(5) Display set up

① Clock



· Select number of digit, then input value using +/- button.

※ Using button

Change digit by ◀ or ▶/⌘, input next digit by ⌘.

② Brightness setting

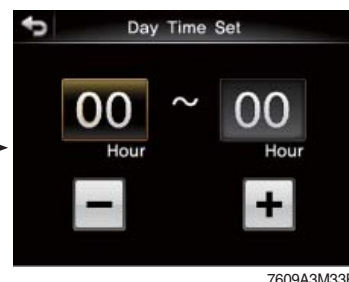
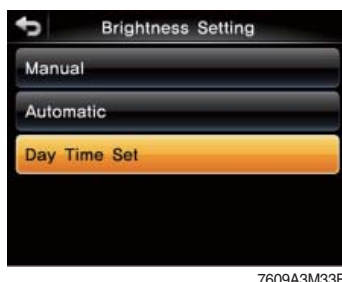
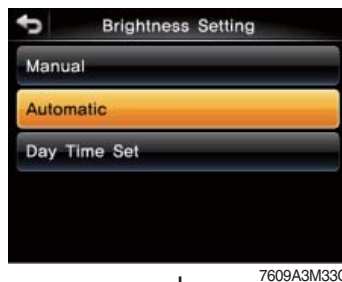
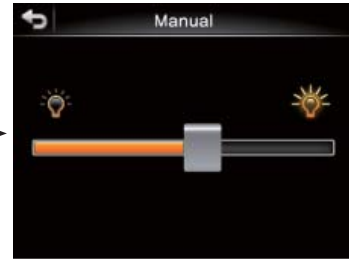
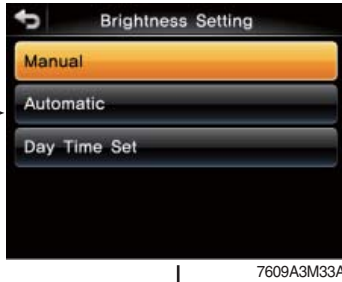

- **Manual**
 - Manual setting for LCD brightness.
- **Automatic**
 - Automatic control of LCD brightness as set level of day/night.
- **Setting day time**
 - Set the time for daylight.
 - If you set the time for daylight, the rest time will be night.
- ※ **Using button**
 - Changing brightness by ◀ or ▶/⌘, input data by ⌘.

③ Display type

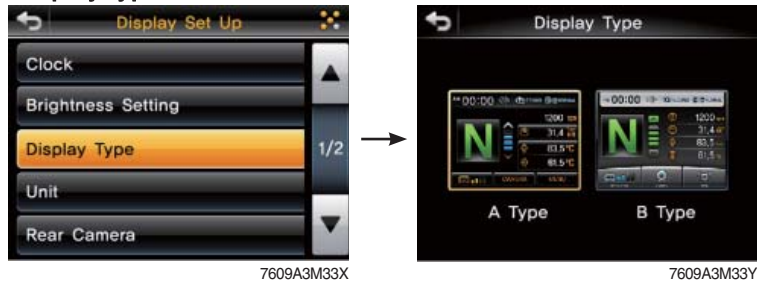

④ Unit

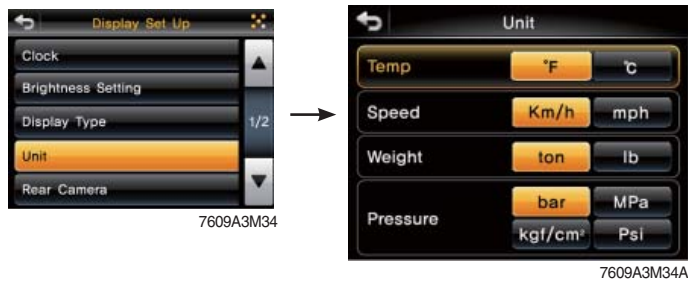

- Temperature : °C ↔ °F
- Speed : km/h ↔ mph
- Weight : ton ↔ lb
- Pressure : bar ↔ Mpa ↔ kgf/m² ↔ psi

※ Using button

- Move to other item by .

⑤ Rear camera

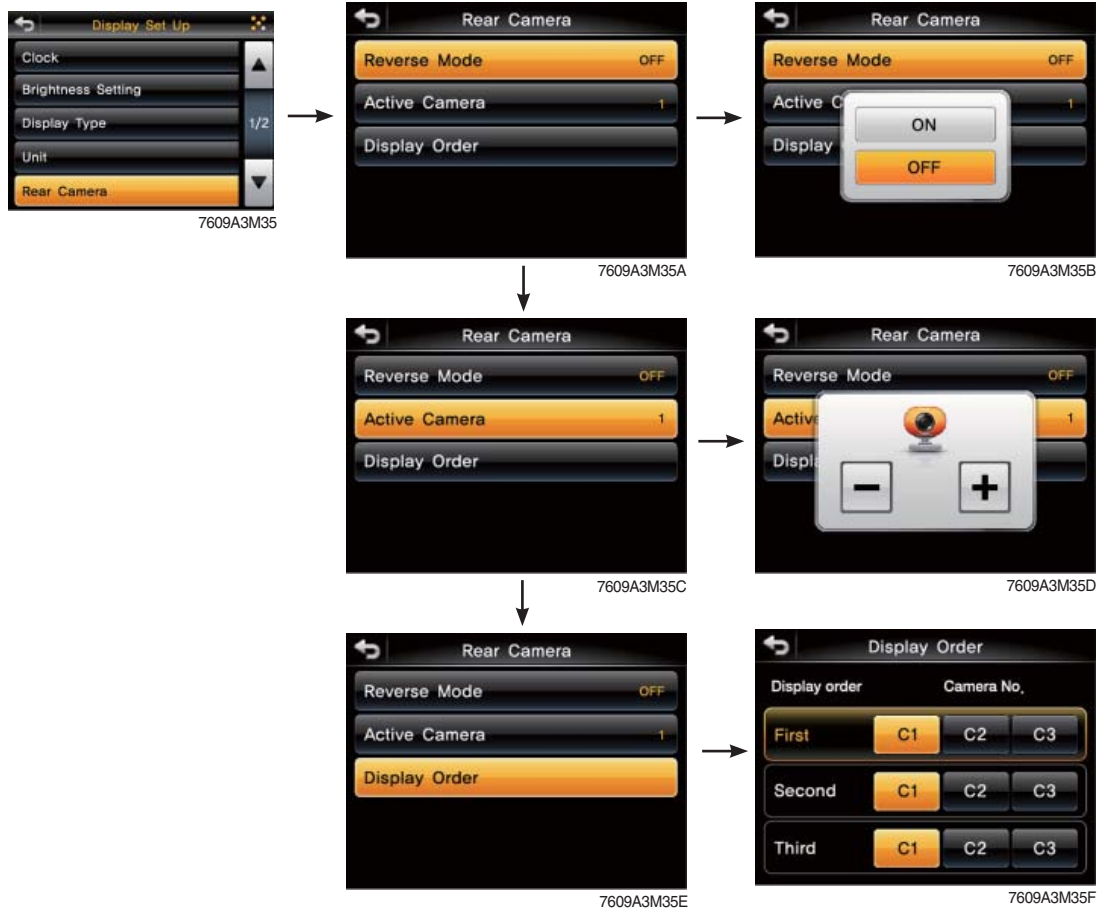

- **Reverse mode**
 - If transmission engages the reverse gear (R1~R3), the camera mode is displayed automatically in main display.
- **Active camera**
 - Three cameras can be installed on the machine.
- **Display order**
 - Set the channel sequence of each camera.
- If the camera was not equipped, this menu is not useful.
- In main display, if the **ESC** button is pushed, the first ordered display camera will be viewed.

⑥ Language



- User can select preferable language and all display are changed the selected language.
- 12 multi-language available.

(6) Multimedia

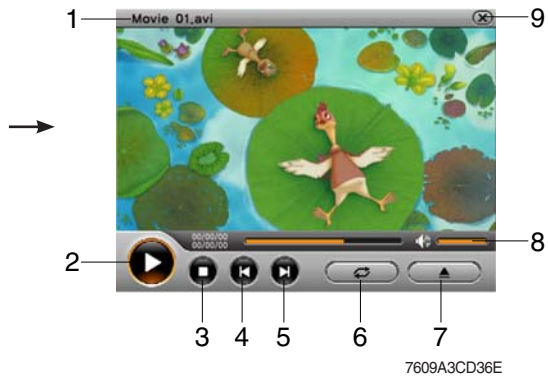

- | | | | |
|---|-----------------------|---|------------------------|
| 1 | File name of playing | 6 | Repeat |
| 2 | Play | 7 | Open file (USB memory) |
| 3 | Stop | 8 | Volume |
| 4 | Previous song (movie) | 9 | Close player |
| 5 | Next song (movie) | | |

3. SWITCHES

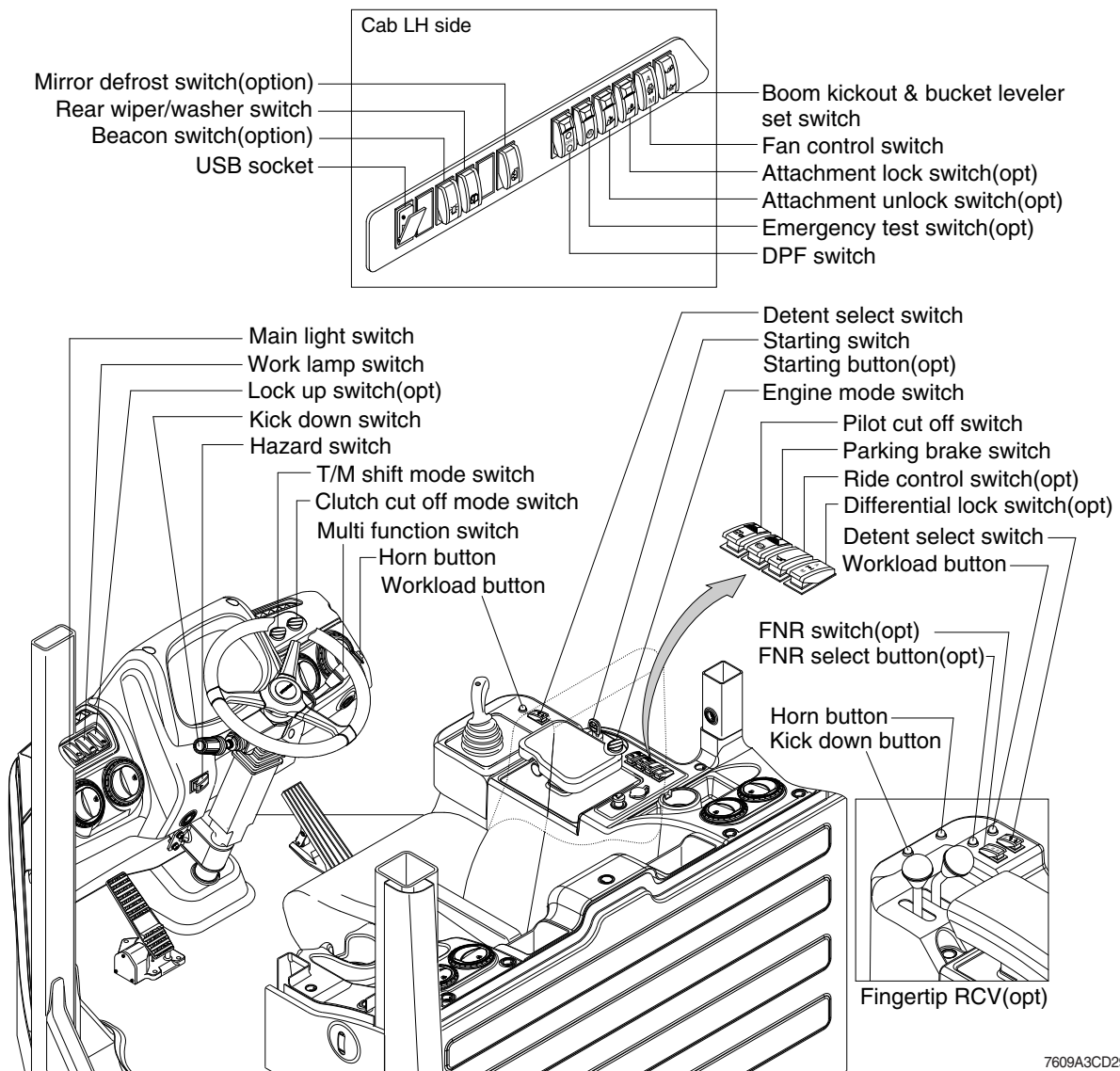

7609A3CD29

1) STARTING SWITCH & STARTING BUTTON (OPT)

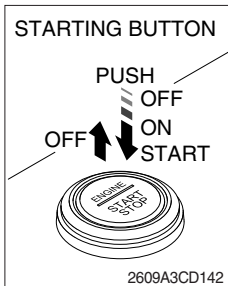
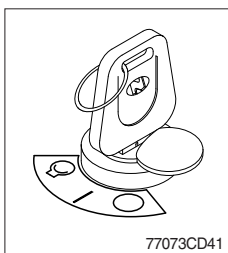

Starting button with smart key tag (opt)

(1) There are three positions, OFF, ON and START.

- ○ (OFF) : None of electrical circuits activate.
- | (ON) : All the systems of machine operate.
- Ⓞ (START) : Use when starting the engine.

Release key immediately after starting.

- ※ If you turn ON the starting switch in cold weather, the fuel warmer is automatically operated to heat the fuel by sensing the coolant temperature. Start the engine in 1~2 minutes after turning ON the starting switch. More time may take according to ambient temperature.
- ※ Key must be in the ON position with engine running maintain electrical and hydraulic function and prevent serious machine damage.

2) HAZARD SWITCH

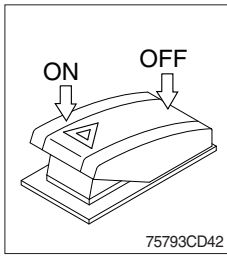

- (1) Use for parking, or loading the machine.
 - (2) Both turn signal lights will flash simultaneously.
- ※ If the switch is left ON for a long time, the battery may be discharged.

3) PILOT CUT OFF SWITCH

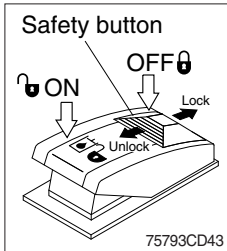

- (1) When the switch is pressed to OFF position, the hydraulic pilot line will be cut off, so the work equipment will not operate.
 - (2) Press the ON position in order to unlock the hydraulic pilot line.
- ※ This switch can be set to ON or OFF position only when the safety button is pulled to the unlock position.

4) PARKING BRAKE SWITCH

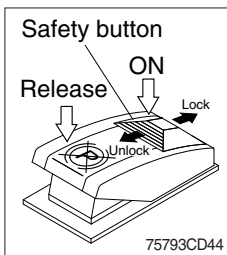

- (1) When the switch is pressed to ON position, the parking brake will start to operate and the cluster warning lamp will come ON.
 - (2) Press the release position in order to disengage the parking brake.
- ※ When operating the gear selector lever, be sure to release the parking brake. If the machine is operated with the parking brake engaged, the brake will overheat and may cause the brake system to go out of order.
- ※ This switch can be set to ON or Release position only when the safety button is pulled to the unlock position.

5) MAIN LIGHT SWITCH

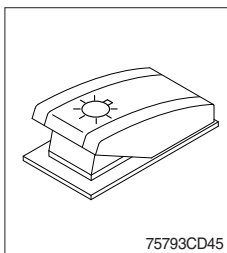

- (1) This switch is used to operate the clearance lamp and head light by two steps.
 - **First step** : Clearance lamp and cluster illumination lamp come ON. Also, all indicator lamp of switches come ON.
 - **Second step** : Head light comes ON.

6) WORK LAMP SWITCH

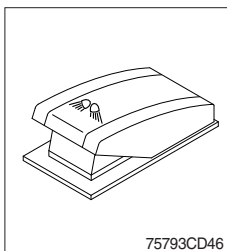

- (1) This switch is used to operate the front and rear work lamps by two steps.
 - **First step** : Front work lamp located on the cab comes ON.
 - **Second step** : Rear work lamp located on the cowl comes ON.

7) REAR WIPER AND WASHER SWITCH

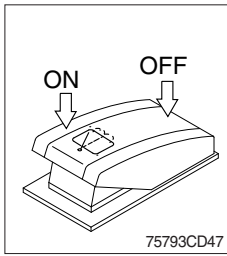

- (1) The switch use to operates the rear wiper and washer by two step.
 - **First step** : The rear wiper operates.
 - **Second step** : The washer liquid is sprayed and the rear wiper is operated only while pressing. If release the switch, return to the first step position.

8) FAN CONTROL SWITCH

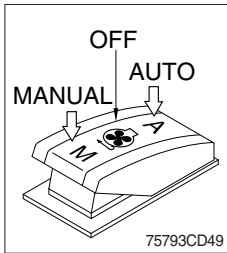

- (1) This switch use to control the cooling fan.
- (2) This switch has three positions.
 - **AUTO** : The fan automatically work in reverse according to set up interval and time.
 - ※ Refer to page 7-37.
 - **OFF** : Only forward rotation is possible.
 - **MANUAL** : The fan rotates reverse only while pressing this position. If release the switch, return to the OFF position.
- (3) On pressing the switch, the indicator lamp is turned ON.

9) DETENT SELECT SWITCH

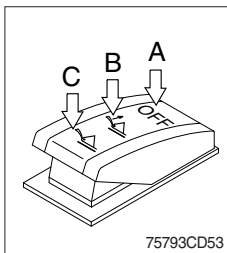

- (1) This switch is used to select the detent functions.
- (2) This switch has three positions.
 - **A** : Detent functions are not operated.
 - **B** : Only boom detent function is operated.
 - **C** : Boom and bucket detent functions are operated.

10) MIRROR DEFROST SWITCH (option)

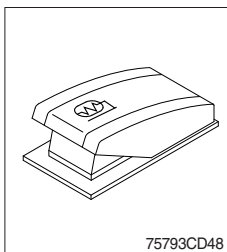

- (1) If the mirror defrost switch is pressed in condition of key ON, it operates for 15 minutes. After 15 minutes, the defrost function stops automatically.
- (2) One more pressing the switch in operation also stops defrost function.
- (3) On pressing the switch, the indicator lamp is turned ON.

11) BEACON SWITCH (option)

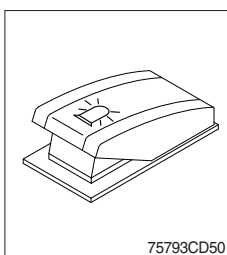

- (1) This switch turns ON the rotary light on the cab.

12) RIDE CONTROL SWITCH (option)

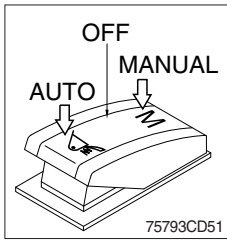

(1) AUTO

Press in the bottom of the ride control switch in order to turn on the automatic ride control. The automatic ride control automatically turns on when the travel speed exceeds a preset speed of approximately 7 km/h. The automatic ride control automatically shuts off during low speed travel (below 7 km/h).

(2) MANUAL

Press in the top of the ride control switch in order to turn on the system for ride control regardless speed. The ride control will smooth the ride of the machine during travel.

(3) OFF

Press the ride control switch to the middle position in order to turn off the system for the ride control.

13) EMERGENCY TEST SWITCH (option)

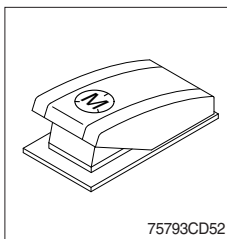

(1) The emergency steering system can be manually tested. Push the switch in order to determine if the emergency steering and the emergency steering lamp are functional.

(2) When the switch is pressed, the emergency steering pump motor will run. The emergency steering lamp will light. If the emergency steering lamp does not light, do not operate the machine.

14) ATTACHMENT LOCK SWITCH (option)

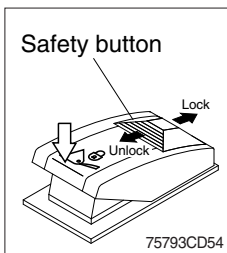

(1) Press this switch in order to engage the quick coupler pins.

(2) If this switch is pressed for 5 seconds, the quick coupler pins move in the engaged position. If the switch is released, the quick coupler pins will remain in the engaged position.

※ **This switch can be pressed only when the safety button is pulled to the unlock position.**

※ **Check for engagement as followings.**

- ① Put down pressure on the attachment.
- ② Back up the machine and make sure that there is no movement between the quick coupler and attachment.

15) ATTACHMENT UNLOCK SWITCH (option)

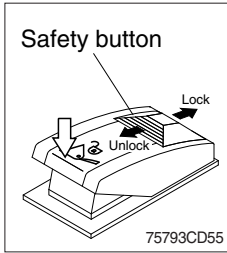

- (1) Press this switch in order to disengage the quick coupler pins.
 - (2) If this switch is pressed for 5 seconds, the quick coupler pins move in the disengaged position.
If the switch is released, the quick coupler pins will remain in the disengaged position.
- ※ **This switch can be pressed only when the safety button is pulled to the unlock position.**

16) BOOM KICK OUT AND BUCKET LEVELER SET SWITCH

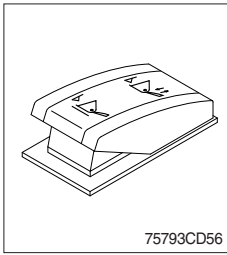

- (1) Press this switch in order to set the boom kickout and bucket leverer.

17) DIFFERENTIAL LOCK SWITCH (option)

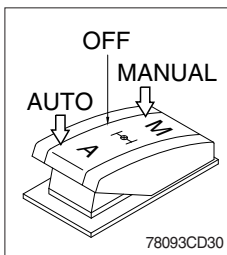

- (1) This switch is used to apply differential lock.
The differential lock gives equal power to both rear wheels and is used in conditions when traction is poor.
 - (2) **Manual mode**
Press the **M** of the switch for the manual mode of the differential lock function. You press the switch, the differential lock will engage immediately and differential lock pilot lamp lights ON.
 - (3) **Auto mode**
Press the **A** of the switch for auto mode of the differential lock function. If you press the switch, the axle differential lock will automatically engage when the differential function is used.
- ※ **While the axle differential lock function is operating, the differential lock pilot lamp lights ON.**
- ※ **Refer to page 7-31.**

18) LOCK UP SWITCH (option)

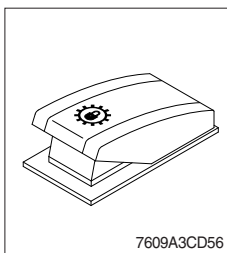

- (1) If you press the switch, the lock-up clutch on the torque converter will automatically activate according to load.
- (2) **Lock-up clutch**
To prevent power loss in the torque converter, the pump rotor and turbine rotor on the torque converter lock together through a direct lock-up clutch.

19) DPF (diesel particulate filter) SWITCH

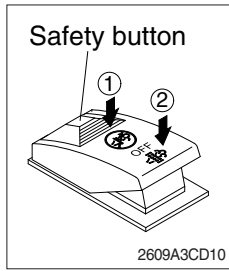

(1) This switch is used to select the regeneration function of the DPF.

(2) Inhibit position (①)

- ① The inhibit position disallows any automatic or manual regeneration of the DPF.
- ② This may be used by operator to prevent regeneration when the machine is operating in a hazardous environment is concerned about high temperature.
- ③ It is strongly recommended that the this position is only activated when high temperatures may cause a hazardous condition.

(3) OFF position

This position will initiate a automatic regeneration of the DPF.

(4) Manual regeneration position (②)

- ① This position will only initiate a manual regeneration of the DPF when the machine is in non-mission condition, engine must run at low idle speed and DPF soot levels are high enough to allow regeneration.
- ② HEST lamp will be illuminated during the entire regeneration.
- ※ Refer to the page 7-27 for details.
- ※ This switch can be move to the manual regeneration position (②) only when the safety button is pulled to backward.
- ※ Also, this switch return to the OFF position when released the manual regeneration position (②).

20) ENGINE MODE SWITCH

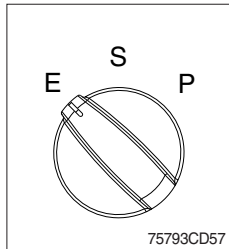

(1) The operator can adjust the machine's performance with this dial switch.

- P (Power) : Maximum power output for hard digging operation or hill climb.
- S (Standard) : General digging and loading operation.
- E (Econo) : Maximum fuel efficiency for general loading.

21) CLUTCH CUT OFF MODE SWITCH

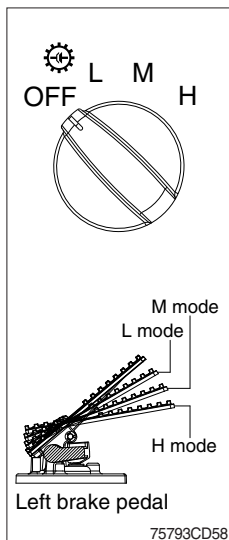

(1) Four modes are available for operator's preference and job condition.

- OFF : The clutch cut off function is disable.
- L (Low) : The clutch is disengaged early for short-distance and rapid loading.
- M (Medium) : The clutch is disengaged normally for general digging and loading operation.
- H (High) : The clutch is disengaged lately for slope ground.

(2) The clutch cut off functions of the left brake pedal depend on the position of the left brake pedal and the position of the clutch cut off mode switch.

Positions for clutch cut off function			
Clutch cut off mode switch	L	M	H
Left brake pedal	L, M, H	M, H	H

22) TRANSMISSION SHIFT MODE SWITCH

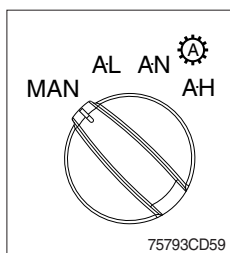

(1) Four modes are available for operator's preference and job condition.

- MAN (Manual) : Machine is operated by selected gear on lever.
- AL (Auto Light) : Automatic shifting point is fast for long-distance transportation and fuel efficiency.
- AN (Auto Normal) : Automatic shifting point is normal without automatic kick-down to 1st gear for general digging and loading operation.
- AH (Auto Heavy) : Automatic shifting point is normal with automatic kick-down to 1st gear for more powerful operation.

23) HORN BUTTON

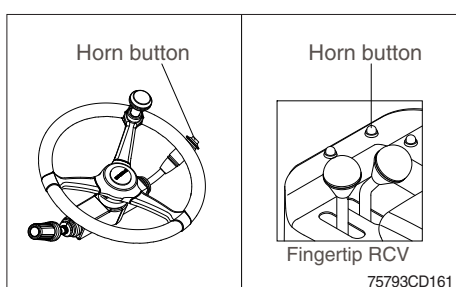

(1) If you press the button on the top of the multi-function switch, the horn will sound.

24) CAB LAMP SWITCH

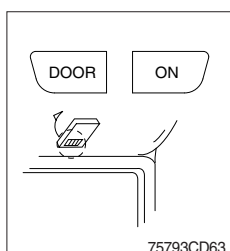

(1) This switch turns ON the cab room lamp.

① DOOR

The lamp comes ON when the door is opened.

When the door is closed the lamp is OFF.

② ON

This switch is used to turn the lamp ON or OFF.

25) WORKLOAD BUTTON SWITCH

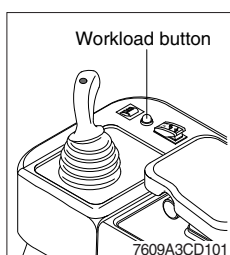

(1) Press the button switch in order to set "Total" display at zero.

※ See page 7-42, weighing system.

26) USB SOCKET

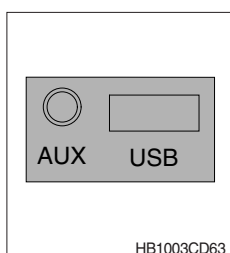

(1) MP3 files are played when a USB device is connected to the USB port.

(2) In addition, the AUX port enables headphone and other devices.

27) KICK DOWN SWITCH

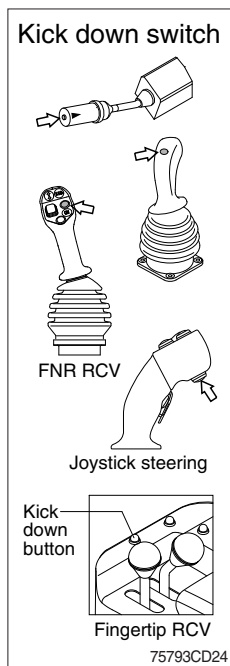

(1) Manual mode

It is effective 2nd speed to 1st speed only and recover to 2nd speed quickly when push the switch one more time.

(2) Automatic mode

① Mode 1 (down/up)

It shifts down quickly from current gear to one step lower speed by pushing the switch and recover to current speed quickly when push the switch one more time.

② Mode 2 (down)

It shifts down from current gear to one step lower speed when push the switch every time.

The kick down function is released in only 1st speed.

※ Refer to page 7-37 for the kick down setting.

※ The normal autoshift function continues after the kick down switch is released.

28) MULTI FUNCTION SWITCH

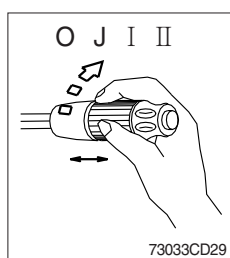

(1) Front wiper and washer switch

- ① When the switch is in J position, the wiper moves intermittently.
- ② When placed in I or II position, the wiper moves continuously.
- ③ If you push the grip of the lever, washer liquid will be sprayed and the wiper will be activated 2-3 times.

※ Check the quantity of washer liquid in the tank. If the level of the washer liquid is LOW, add the washer liquid (in cold, winter days) or water. The capacity of the tank is 1 liter.

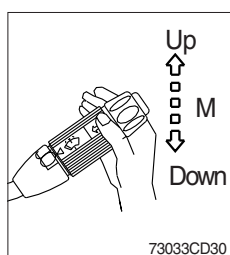

(2) Dimmer switch

- ① This switch is used to turn the head lights direction.

② Switch positions

- Up : To flash for passing
- Middle : Head lights low beam ON
- Down : Head lights high beam ON

- ③ If you release the switch when it's in up position, the switch will return to middle.

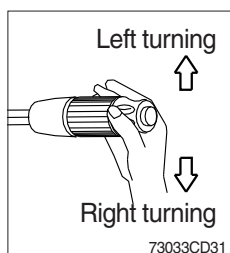

(3) Turning switch

- ① This switch is used to warn or signal the turning direction of the machine to other vehicles or equipment.
- ② Push the lever up for turning left, pull the lever down for turning right.