

3. MONITORING SYSTEM

1. CLUSTER

The gauges panel consists of gauges and monitors as shown below, to warn the operator in case of abnormal machine operation or conditions for the appropriate operation and inspection.

- Gauges : Indicate operating status of the machine.
- Warning lamp : Indicate abnormality of the machine.
- Pilot lamp : Indicate operating status of the machine.

※ The monitor installed on this machine does not entirely guarantee the condition of the machine. Daily inspection should be performed according to chapter 6, MAINTENANCE.

※ When the monitor provides a warning immediately check the problem, and perform the required action.

■ Cluster [Machine serial no. ; HL740-7(-#0974),HL740TM-7(-#0348)]

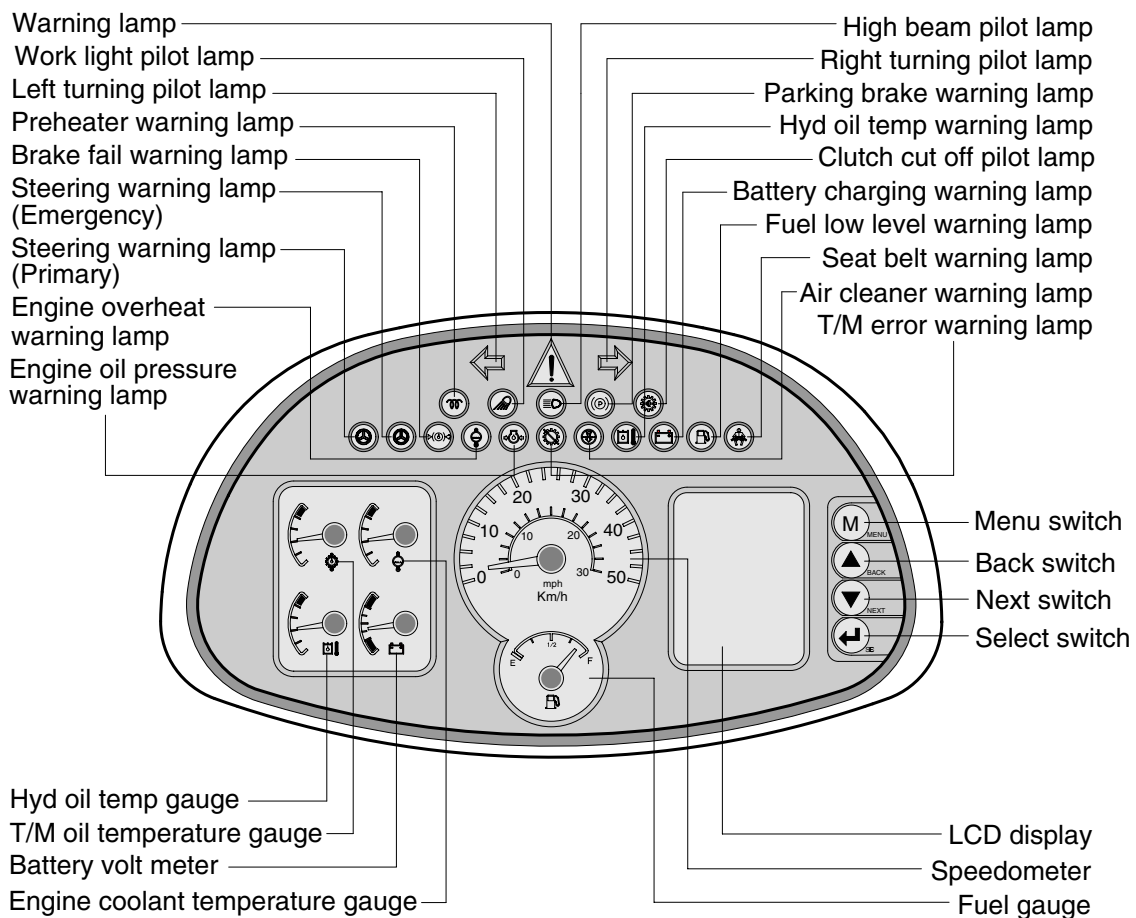

77073CD02

■ Cluster [Machine serial no. ; HL740-7(#0975-),HL740TM-7(#0349-)]

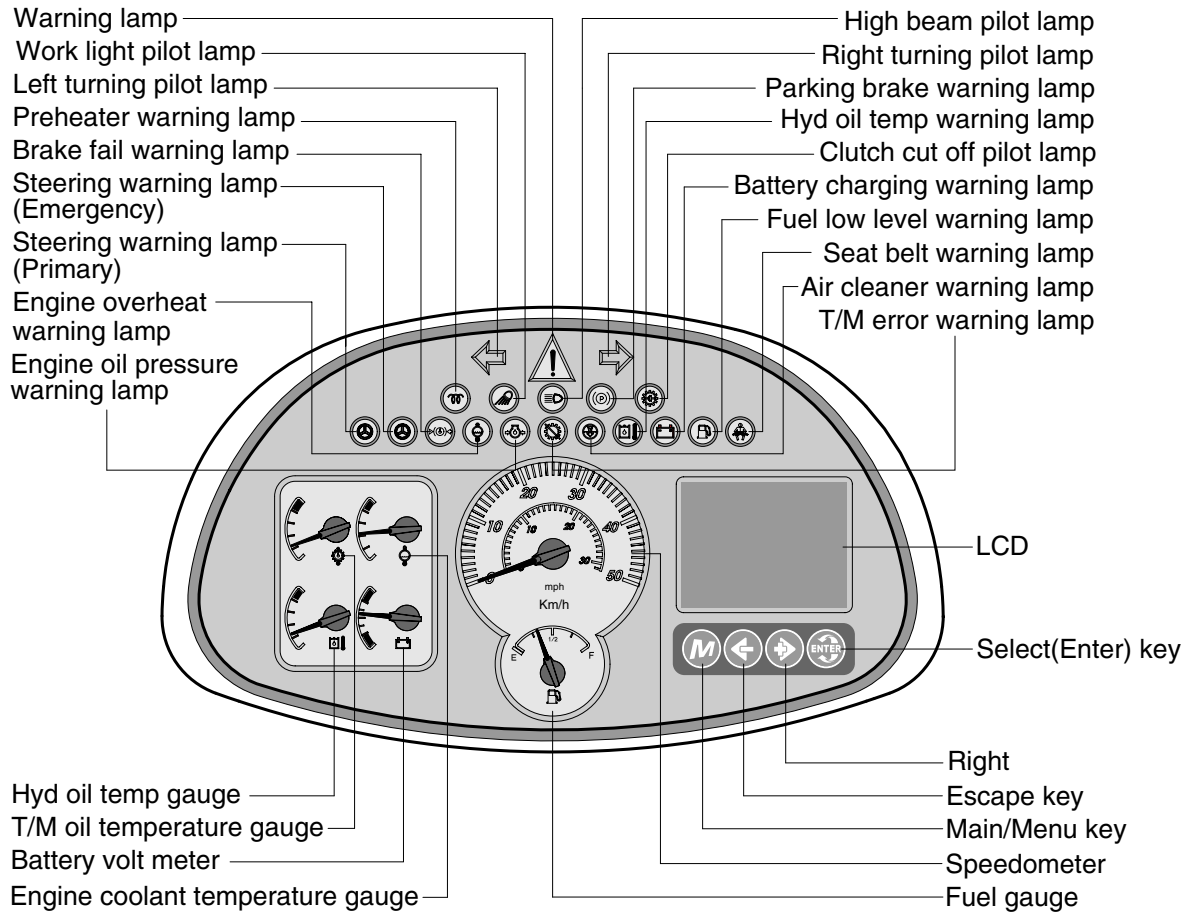

77073CD02-1

1) SPEEDOMETER

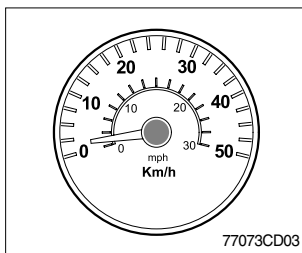

(1) The speedometer displays the speed of machine in mph and km/h.

2) FUEL GAUGE

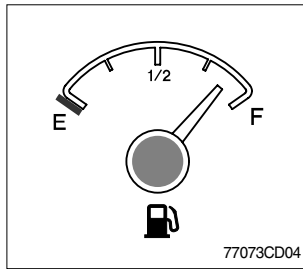

- (1) This gauge indicates the amount of fuel in the fuel tank.
 - (2) Fill the fuel when the indicator moves **E** point, refuel as soon as possible to avoid running out of fuel.
- ※ **If the gauge indicates below E point even though the machine is on the normal condition, check the electric device as that can be caused by the poor connection of electricity or sensor.**

3) ENGINE COOLANT TEMPERATURE GAUGE

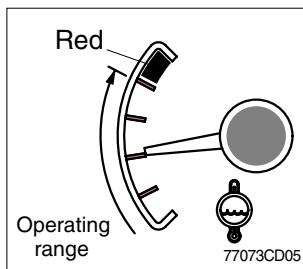

- (1) This indicates the temperature of coolant.
 - Red range : Above 104° C (219° F)
- (2) Keep idling engine at low speed until the indicator is in the operating range.
- (3) If the indicator is in the red range, turn OFF the engine, check the radiator and engine.

4) TRANSMISSION OIL TEMPERATURE GAUGE

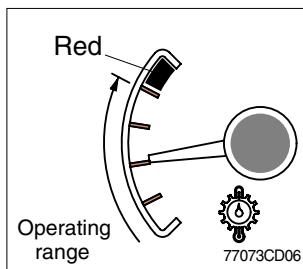

- (1) This range indicates the temperature of transmission oil.
 - Red range : Above 107° C (225° F)
- (2) Keep idling engine at low speed until the indicator is in the operating range.
- (3) If the indicator is in the red range, it means the transmission is overheated. Be careful that the indicator does not move into the red range.

5) BATTERY VOLT METER

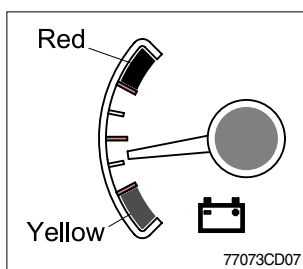

- (1) This gauge indicates the voltage in the charging system when the engine is running.
- (2) If the indicator is below 24V (Yellow range), it means that the electricity is being discharged. If the indicator is above 30V (Red range), an unusually high voltage may damage the alternator. Check the charging system in both cases.

6) HYD OIL TEMPERATURE GAUGE

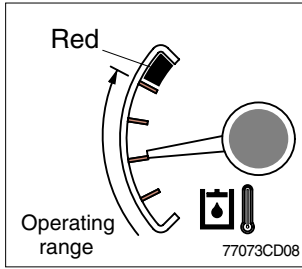

- (1) This range indicates the temperature of hydraulic oil.
 - Red range : Above 105° C (221° F)
- (2) Keep idling engine at low speed until the indicator is in the operating range.
- (3) If the indicator is in the red range, reduce the load on the system. If the gauge stays in the red range, stop the machine and check the cause of the problem.

7) WARNING LAMP



- (1) When all warning lamp or fault codes are being displayed, this warning lamp will flash.
- (2) When this warning lamp flashes, machine must be checked or serviced as soon as possible.

8) DIRECTION PILOT LAMP

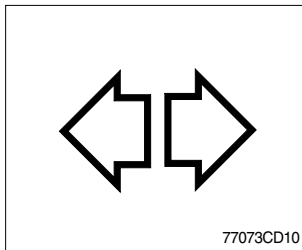

- (1) This lamp flashes when the signal indicator lever is moved.

9) WORK LIGHT PILOT LAMP

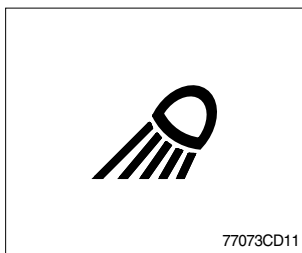

- (1) This lamp lights ON when work lamp switch is pressed.

10) HIGH BEAM PILOT LAMP

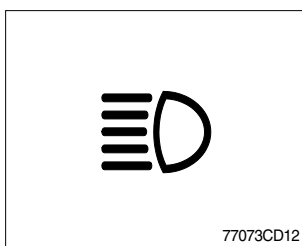

- (1) This lamp works when the illuminating direction is upward.
- (2) This lamp comes ON when the dimmer switch is operated, e.g., when passing another vehicle.

11) PARKING BRAKE WARNING LAMP

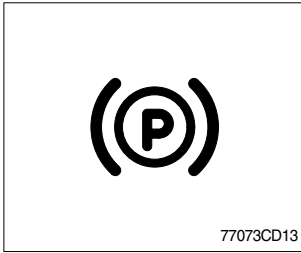

- (1) When the parking brake is actuated, the lamp lights ON.
- ※ Check the lamp is OFF before driving.

12) PREHEATER WARNING LAMP

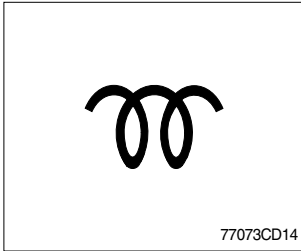

- (1) This lamp lights ON when start switch is turned clockwise to the ON position. Light will turn off after approximately 15~45 seconds, depending on engine temperature, indicating that preheating is completed.
- (2) When the lamp goes out the operator should start cranking the engine.

13) CLUTCH CUT OFF PILOT LAMP

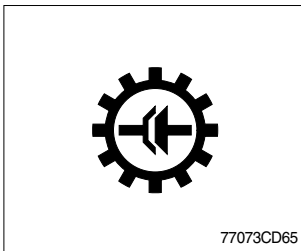

- (1) When the clutch cut off switch is pressed, the lamp lights ON.

14) BRAKE FAIL WARNING LAMP

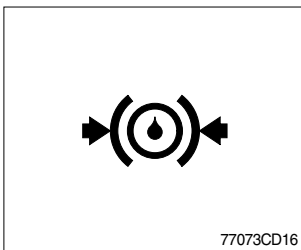

- (1) The lamp lights ON when the oil pressure of service brake drops below the normal range.
 - (2) When the lamp is ON, stop the engine and check for its cause.
- ※ Do not operate until any problems are corrected.

15) ENGINE OVERHEAT WARNING LAMP

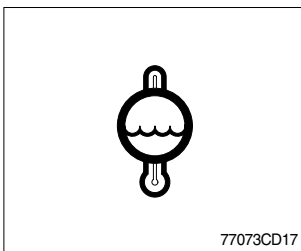

- (1) This lamp is turned ON when the temperature of cooling water is over the normal temperature(104° C, 219° F)
- (2) Check the cooling system when the lamp is ON.

16) ENGINE OIL PRESSURE WARNING LAMP

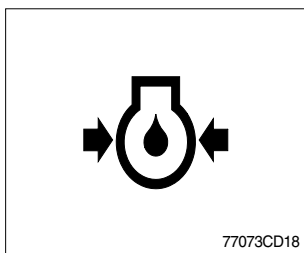

- (1) This lamp is comes ON after starting the engine because of the low oil pressure.
- (2) If the lamp comes ON during engine operation, shut OFF engine immediately. Check oil level.

17) TRANSMISSION ERROR WARNING LAMP

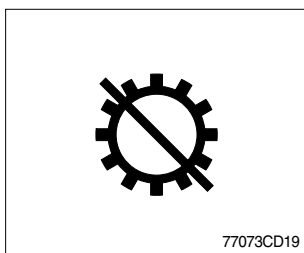

- (1) This lamp lights ON and the LCD display show the error codes when an error occurs in the transmission.
 - (2) Immediately pull the machine to a convenient stop. Stop the engine. Investigate the cause.
- ※ **Consult a HYUNDAI dealer to investigate the cause.**
 - ※ **Do not operate until the cause has been corrected.**

18) AIR CLEANER WARNING LAMP

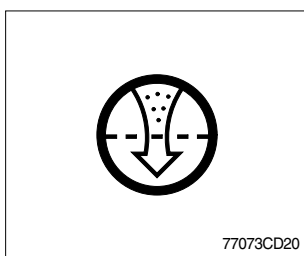

- (1) This lamp operates by the vacuum caused inside when the filter of air cleaner is clogged.
- (2) Check the filter and clean or replace it when the lamp is ON.

19) HYD OIL TEMPERATURE WARNING LAMP

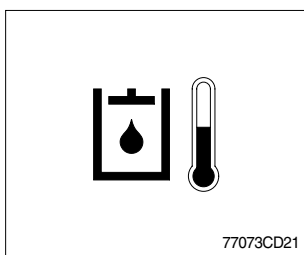

- (1) This warning lamp operates and the buzzer sounds when the temperature of hydraulic oil is over 105° C(221° F).
- (2) Check the hydraulic oil level when the lamp is turned ON.
- (3) Check for debris between oil cooler and radiator.

20) BATTERY CHARGING WARNING LAMP

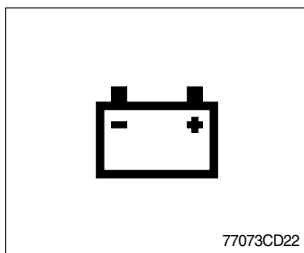

- (1) This lamp is ON when key ON, it is turned OFF after starting the engine.
- (2) Check the battery charging circuit when this lamp comes ON, during engine operation.

21) FUEL LOW LEVEL WARNING LAMP

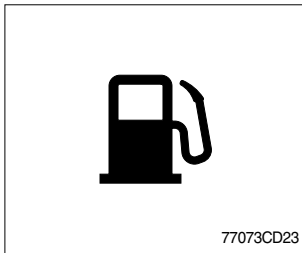

(1) Fill the fuel immediately when the lamp is turned ON.

22) SEAT BELT WARNING LAMP

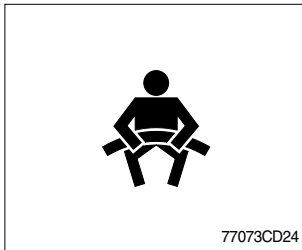

(1) This lamp lights ON for the first five seconds after starting the machine.

23) STEERING WARNING LAMP (Option)

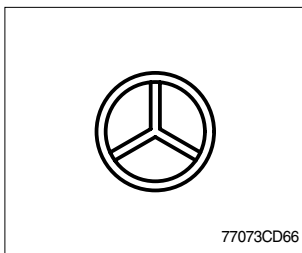

(1) Primary

If the oil pressure in the steering pump drops, the lamp will light up. If this lamp flashes during operation, the action alarm should sound.

※ **If the lamp lights up, immediately pull the machine to a safe place and stop the machine.**

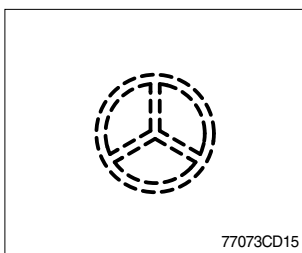

(2) Emergency

This lamp will flash if the oil pressure in the emergency steering pump drops. The lamp notifies the operator that if the steering system also failed at this time, there is no emergency steering system for backup.

※ **Immediately pull the machine to a convenient stop and stop the engine.**

※ **This machine is equipped with ground driven emergency steering pump. It is normal for the lamp to flash after 5 seconds when the machine is stopped.**

24) LCD [Machine serial no. ; HL740-7(-#0974),HL740TM-7(-#0348)]

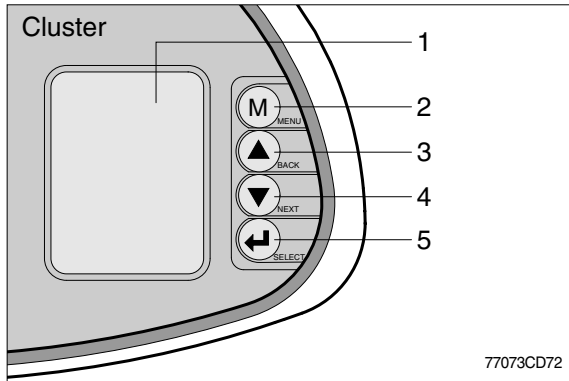

- 1 () LCD
- 2 () MENU
 - Display main menu
 - Return to the normal display
- 3 () BACK
 - Return to the previous menu
- 4 () NEXT
 - Move to the next selection
- 5 () SELECT
 - Activate the currently chosen item

(1) Normal display

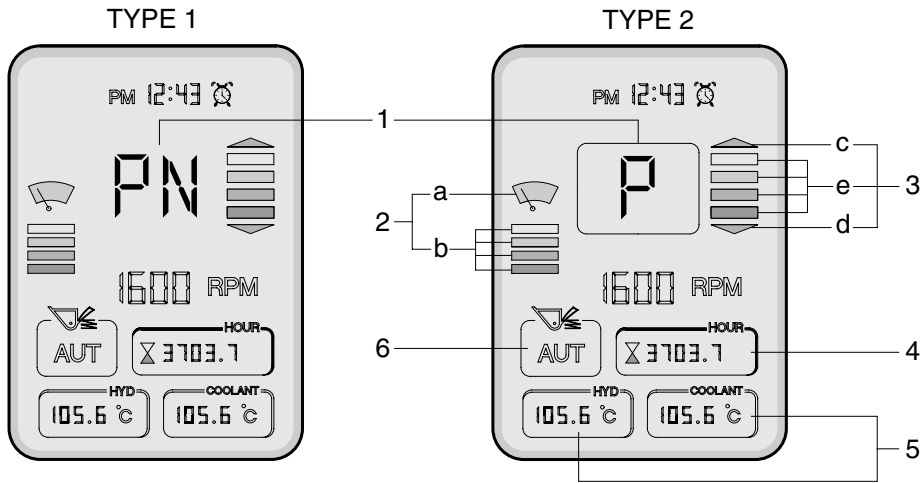

77073CD73

No	Symbol	Meaning	Remark
1		Forward, reverse, neutral	LCD type 1, Display during AEB mode
	F, R, N	Forward, reverse, neutral	LCD type 2, Display during AEB mode
	1, 2, 3, 4	Actual gear	-
	P	Parking brake mode active	-
2	a	Wiper motor intermittently operating	-
	b	When operating intermittently, it shows an operating time interval.	-
3	c, d	Up and down shifting	c : Forward, d : Reverse
	e	Pre-selected gear	-
4		Hour meter	Display the total operation hours of the machine
5		Engine coolant temperature	Display in accordance with selected items
6 (Option)	AUT	Ride control mode active	Ride control switch AUTO position, see page 7-36-4
	ON	Ride control mode active	Ride control switch ON position, see page 7-36-4
	OFF	Ride control mode turn off	Ride control switch MIDDLE position, see page 7-36-4

※ Both type1 and type2 are LCD modes and they can be changed each other by operator's selection.

(2) Display map

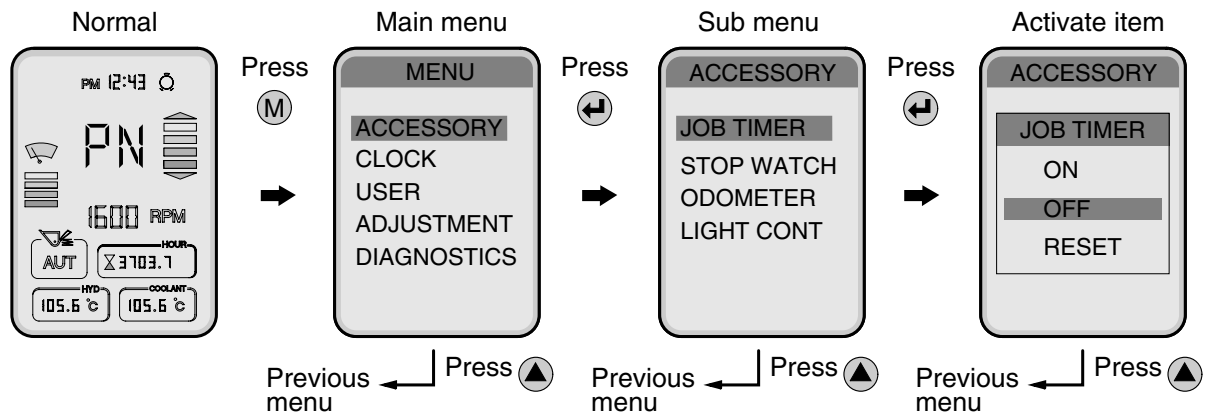

77073CD74

Main group	Sub group	Meaning	Display on LCD	
Accessory	Job timer	<ul style="list-style-type: none"> Measure the various job time. Press Left Arrow : Display ON, OFF or RESET 		
	Stop watch	<ul style="list-style-type: none"> Measures time in seconds. Press Left Arrow : Start. Press Left Arrow again : Stop. 	-	
	Odometer	Latest	Distance until recent times.	
		Total	Total distance.	
	Light control	<ul style="list-style-type: none"> Control of LCD display luminosity. Brightness control : Up Arrow , Down Arrow . 	-	
Clock	Time set	<ul style="list-style-type: none"> When 12H or 24H is selected, the current hour appears. Up Arrow , Down Arrow : input, Left Arrow : setting. 	PM 12:43	
	Clock ON/OFF	<ul style="list-style-type: none"> Left Arrow : Clock display ON or OFF. 		
	Alarm	1	<ul style="list-style-type: none"> Alarm setting. It is possible to set 3 alarms. Stop alarming : Left Arrow or buzzer stop switch. 	
		2		
3				
User	Alternate idle	<ul style="list-style-type: none"> Raise the idle rpm to 1200rpm automatically to warm up the engine. 	-	
	Auto 1/2	Mode 1 (1st-4th)	Automatic travelling speed is applied from 1st to 4th gear.	-
		Mode 2 (2nd-4th)	Automatic travelling speed is applied from 2nd to 4th gear.	-
	Quick shift	Mode 1 (Down/Up)	Press button once : Shift down, press button again ; shift up.	-
		Mode 2 (Down)	Press button every time : Shift to lower gear respectively.	-
	Aux-sw	Auto Select	<ul style="list-style-type: none"> ON : Transmission auto condition. OFF : Transmission semi-auto condition. 	
Clutch Cut-off		<ul style="list-style-type: none"> ON : Clutch cut-off is activated. OFF : Clutch cut-off is cancelled. 	-	

Main group	Sub group	Meaning	Display on LCD display	
Adjustment	Unit	· Choose between metric and inch unit display.		
	Wiper Intermittence	· When using the intermittent function of wiper motor, it regulates operation time.		
	Alternate RPM	· Regulate idle rpm. · Press ▲, ▼ : Adjust idle rpm increments (or decrement) by 25rpm.	-	
	Pulse	· Press ← : Modification.	-	
	AEB	· It controls the disk interval of the transmission, automatically.	-	
	ENG/KOR	· English : Display in English. · Korean : Display in Korean.	-	
	Display 1/2	· Type 1 : Indicate with the symbol. · Type 2 : Indicate with a letter.		
Diagnostics	Machine	Fault Code	· Error code display. · Refer to page 7-31.	-
		Monitor	· Hydraulic temperature and battery voltage display. · Press ← : Display ON or OFF.	
	Engine	Fault Code	· Error code display. · Consult a Hyundai dealer to error code.	-
		Monitor	· Engine coolant temperature display. · Press ← : Display ON or OFF.	
	Transmission	Fault Code	· Error code display. · Consult a Hyundai dealer to error code.	-
		Monitor	Transmission oil temperature display. · Press ← : Display ON or OFF.	

(3) Machine fault code

When selecting the fault code menu, it shows all of the fault codes which mean abnormal conditions of present time.

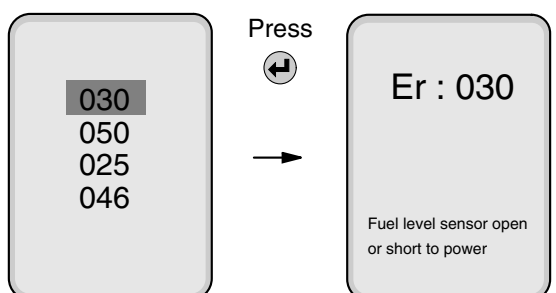

77073CD60

- ※ To go out from fault explanation window, press ▲ button.
(Press ←, M to go out to first menu.)
- ※ **No error** will be indicated in case that there's no fault.

Description	Code	Meaning	Remark
Electrical system	010	Power input voltage low	Below 18V
	011	Power input voltage high	Above 38V
	012	Alternator voltage low	Below 5V
	013	Alternator voltage high	Above 36V
	014	Buzzer circuit open or short to ground	
	015	Buzzer circuit short to power	
Hydraulic system	020	Hydraulic oil temperature sensor open or short to power	
	021	Hydraulic oil temperature sensor short to ground	
Engine system	030	Fuel level sensor open or short to power	
	031	Fuel level sensor short to ground	
	034	Cooling fan driving valve open or short to ground	
	035	Cooling fan driving valve short to power	
T/M system	050	Auto select switch supply power open or short to power	
	051	Auto select switch supply power short to ground	
	052	Clutch cutoff supply power open or short to power	
	053	Clutch cutoff supply power short to ground	
Steering system	060	Emergency steering relay open or short to ground	Option
	061	Emergency steering relay short to power	Option
Communication	070	MCU communication error	
	071	TCU communication error	
	072	ECM communication error	

MCU : Machine control unit TCU : Transmission control unit ECM : Engine control module

LCD [Machine serial no. ; HL740-7(#0975-),HL740TM-7(#0349-)]

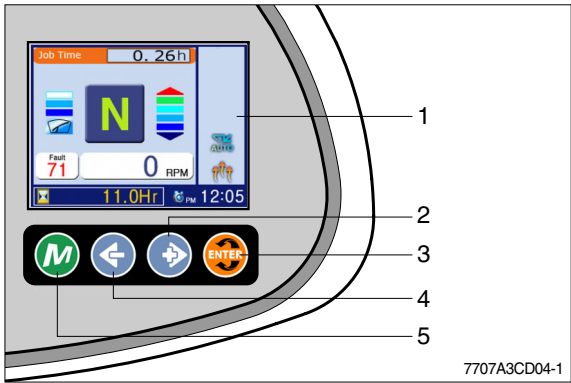

- 1 LCD
- 2 Right
Move to the next selection
- 3 Select(Enter)
Activate the currently chosen item
- 4 Escape
Return to the previous menu
- 5 Main, Menu
- Display menu
- Return to the main display

(1) Main display

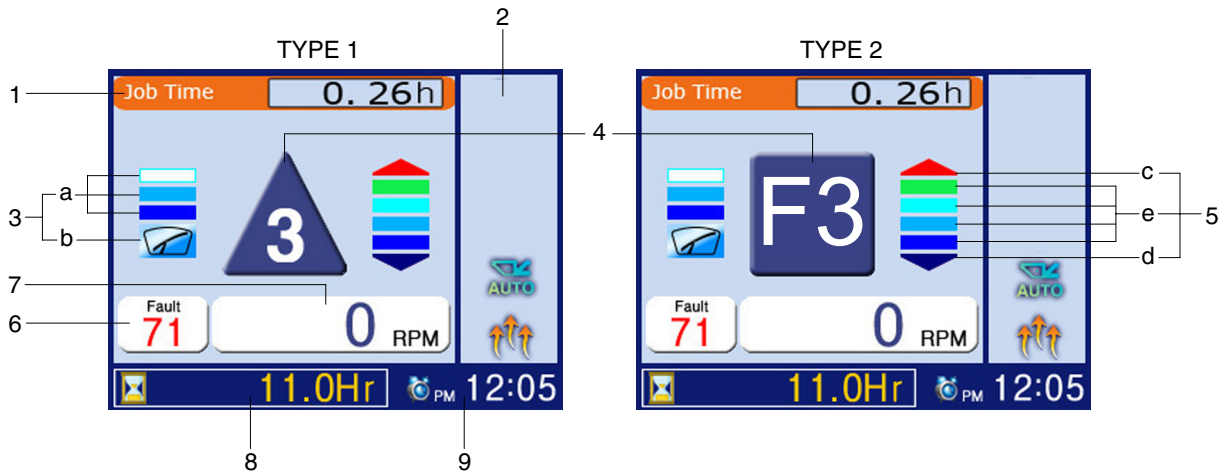

7707A3CD10-1







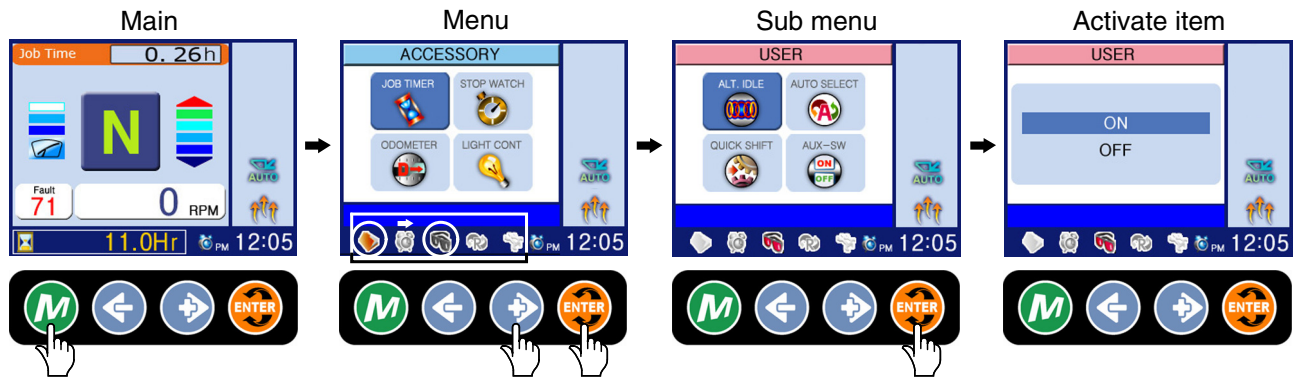





No	Symbol	Meaning	Remark
1		Monitoring information	Job timer, Odometer, Hydraulic temperature, Battery voltage, Coolant temperature, T/M oil temperature.
2		State information	Ride state(option), Warming up
3	a	Wiper display	When operating intermittently, it shows an operating time interval
	b		Wiper motor intermittently operating
4		Actual gear display	Forward, reverse, neutral LCD type 1
	F, R, N		Forward, reverse, neutral LCD type 2
	1, 2, 3, 4		Actual gear
	P		Parking brake mode active
5	c, d	Select gear display	Up and down shifting c: Forward, d: Reverse
	e		Pre-selected gear Automatic mode
6		Fault code display	Fault code state display
7		Engine rpm display	Now engine rpm state display
8		Hour meter display	Hour meter state display
9		Timer & alarm display	Now time & alarm state display











※ Both type1 and type2 are LCD modes and they can be changed each other by operator's selection.
(Adjustment/Display, see page 7-34)

(2) Display map



7707A3CD11-1

Main group	Sub group	Meaning	Display on LCD	
Accessory 	Job timer	<ul style="list-style-type: none"> Measure the various job time. Press  : Display ON, OFF or RESET 	Job Time <input type="text" value="1.26h"/>	
	Stop watch	<ul style="list-style-type: none"> Measures time in seconds. Press  : Start. Press  again : Stop. 	-	
	Odometer	Latest	Distance until recent times.	Latest <input type="text" value="20.5 Km"/>
		Total	Total distance.	Total <input type="text" value="30.5 Km"/>
	Light control	<ul style="list-style-type: none"> Control of LCD display luminosity. Brightness control :  . 	-	
Clock 	Time set	<ul style="list-style-type: none"> When 12H or 24H is selected, the current hour appears.  : input,  : setting. 	PM 22:05	
	Clock ON/OFF	<ul style="list-style-type: none">  : Clock display ON or OFF. 		
	Alarm	1	<ul style="list-style-type: none"> Alarm setting. It is possible to set 3 alarms. Stop alarming :  	
		2		
3				
User 	Alternate idle	ON	<ul style="list-style-type: none"> Raise the idle rpm to 1200rpm automatically to warm up the engine. 	-
		OFF		
	Auto select	Mode 1 (1st-4th)	Automatic travelling speed is applied from 1st to 4th gear.	-
		Mode 2 (2nd-4th)	Automatic travelling speed is applied from 2nd to 4th gear.	-
	Quick shift	Mode 1 (DownUp)	Press button once : Shift down, press button again ; shift up.	-
		Mode 2 (Down only)	Press button every time : Shift to lower gear respectively.	-
Aux-sw	Auto select	<ul style="list-style-type: none"> ON : Transmission auto condition. OFF : Transmission semi-auto condition. 		
	Clutch cut-off	<ul style="list-style-type: none"> ON : Clutch cut-off is activated. OFF : Clutch cut-off is cancelled. 	-	



Main group	Sub group		Meaning	Display on LCD
Adjustment 	Unit	MKS	· Choose between metric and inch unit display.	Total 50.7 Km
		ENG		Total 31.5 Mile
	Wiper Intermittence		· When using the intermittent function of wiper motor, it regulates operation time.	
	Alternate RPM		· Regulate idle rpm. · Press  : Adjust idle rpm increments (or decrement) by 25rpm.	-
	Pulse		· Press  : Modification.	-
	AEB		· It controls the disk interval of the transmission, automatically.	ST
	Model		· It is set at the factory, so there's no need to change.	-
	ENG/KOR		· English : Display in English. · Korean : Display in Korean.	-
Display 1/2		· Type 1 : Indicate with the symbol. · Type 2 : Indicate with a letter.	 , 	
Diagnostics 	Machine	Fault code	· Error code display. · Refer to page 7-35.	-
		Monitor	· Hydraulic temperature and battery voltage display. · Press  : Display ON or OFF.	HYD temp 100.6°C Bat Volt 27.5 V
	Engine	Fault code	· Error code display. · Consult a Hyundai dealer to error code.	-
		Monitor	· Engine coolant temperature display. · Press  : Display ON or OFF.	Coolant Temp 57.6°C
	Transmission	Fault code	· Error code display. · Consult a Hyundai dealer to error code.	-
		Monitor	· Transmission oil temperature display. · Press  : Display ON or OFF.	Oil Temp 37.6°C
	Version		· Display the controller(MCU) and cluster version.	-

(3) Machine fault code

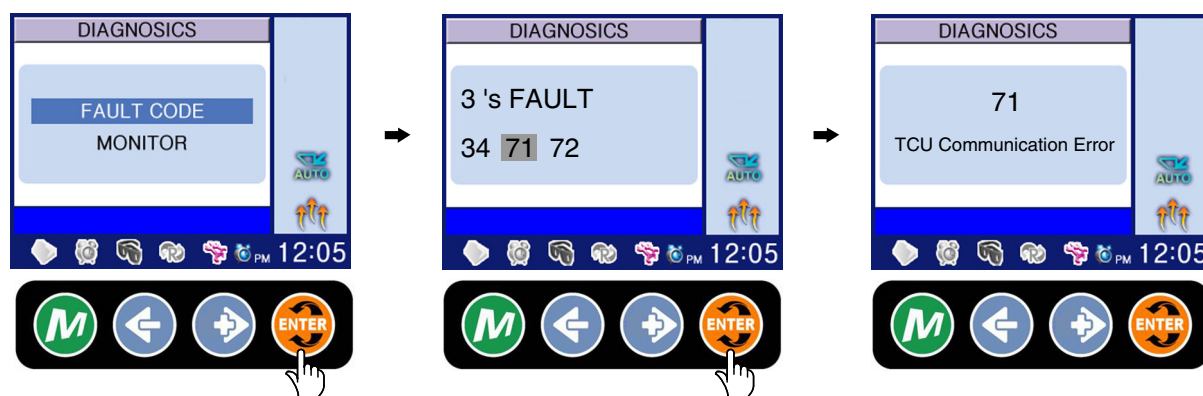
When selecting the fault code menu, it shows all of the fault codes which mean abnormal conditions of present time.



7707A3CD36-1

- ※ To go out from fault explanation window, press ← button.
(Press  ,  to go out to main.)
- ※ **No error** will be indicated in case that there's no fault.

Description	Code	Meaning	Remark
Electrical system	010	Power input voltage low	Below 18V
	011	Power input voltage high	Above 38V
	012	Alternator voltage low	Below 5V
	013	Alternator voltage high	Above 36V
	014	Buzzer circuit open or short to ground	
	015	Buzzer circuit short to power	
Hydraulic system	020	Hydraulic oil temperature sensor open or short to power	
	021	Hydraulic oil temperature sensor short to ground	
Engine system	030	Fuel level sensor open or short to power	
	031	Fuel level sensor short to ground	
	034	Cooling fan driving valve open or short to ground	
	035	Cooling fan driving valve short to power	
T/M system	050	Auto select switch supply power open or short to power	
	051	Auto select switch supply power short to ground	
	052	Clutch cutoff supply power open or short to power	
	053	Clutch cutoff supply power short to ground	
Steering system	060	Emergency steering relay open or short to ground	Option
	061	Emergency steering relay short to power	Option
Communication	070	MCU communication error	
	071	TCU communication error	
	072	ECM communication error	

MCU : Machine control unit TCU : Transmission control unit ECM : Engine control module

(4) Transmission warning

Symbol	Meaning	Remarks
LF, LR	Limp home gear	-
F/R/△/▽ flashing	Direction F or R selected while turbine speed is too high, CAUTION gear will engage if turbine speed drops	-
	Oil temperature too low, no gear available	Warm up engine / transmission
WS	Warning sump temperature	Changes between actual gear/direction while driving, in neutral only displayed if no fault is detected
WT	Warning torque converter temperature	Changes between actual gear/direction while driving, in neutral only displayed if no fault is detected
WE	Warning high engine speed	Changes between actual gear/direction while driving, in neutral only displayed if no fault is detected

2. SWITCHES

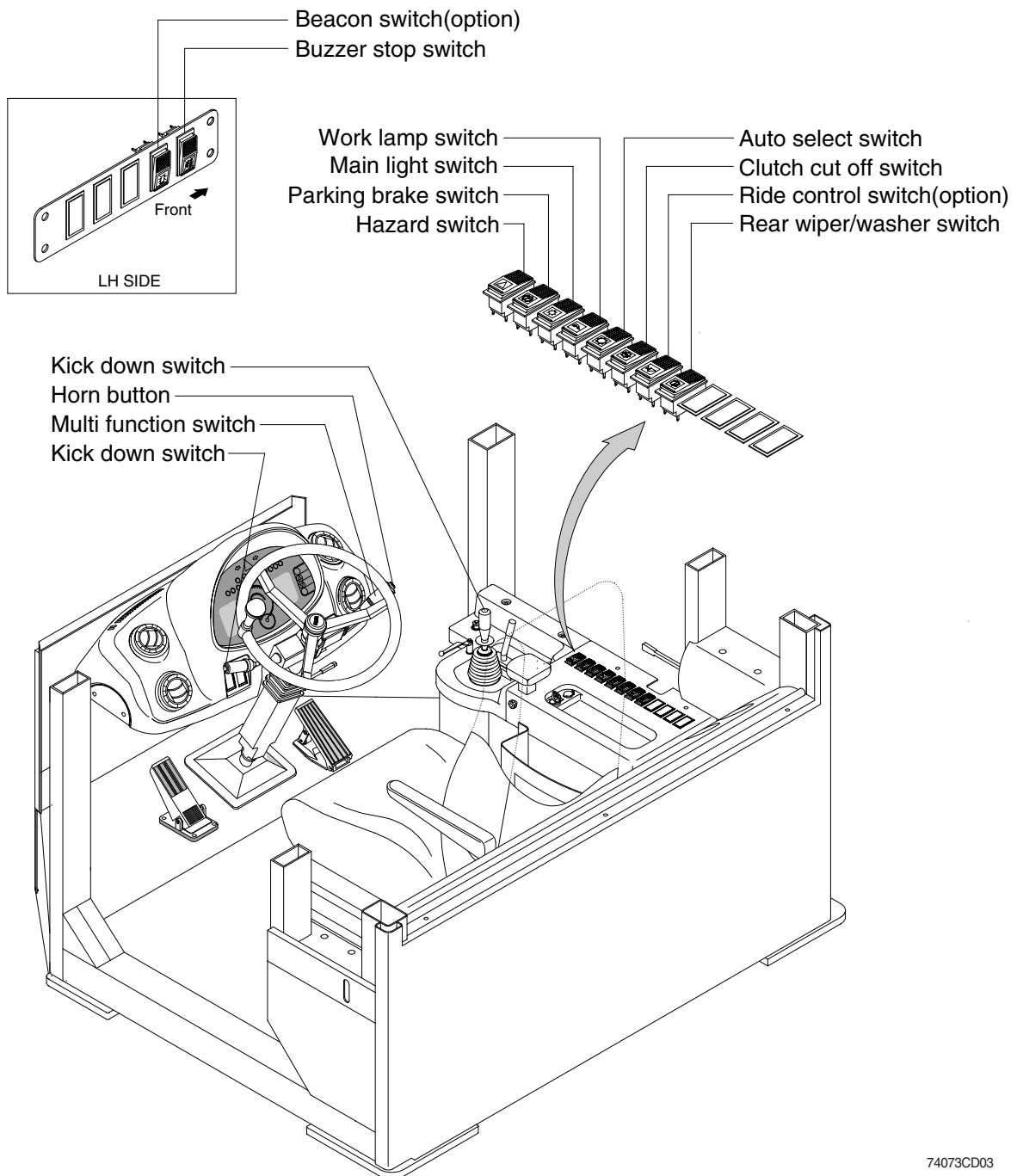

74073CD03

1) STARTING SWITCH

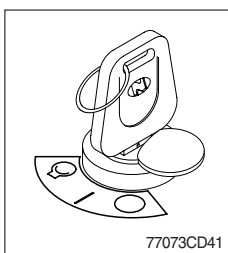

(1) There are three positions, OFF, ON and START.

- ○ (OFF) : None of electrical circuits activate.
- | (ON) : All the systems of machine operate.
- ◯ (START) : Use when starting the engine.

Release key immediately after starting.

※ **Key must be in the ON position with engine running maintain electrical and hydraulic function and prevent serious machine damage.**

2) HAZARD SWITCH

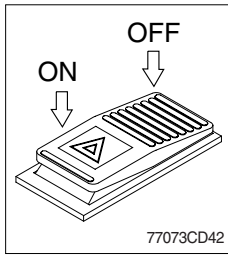

(1) Use for parking, or roading machine.

- ※ If the switch is left ON for a long time, the battery may be discharged.

3) CLUTCH CUT OFF SWITCH

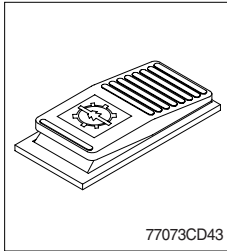

(1) This switch is pressed, it will cut off the clutch when brake operates.

- ※ Be careful not to use this switch when driving on a slope.
- (2) When the switch failure occurs, it will be able to operate a clutch off function from LCD.
- ※ Refer to page 7-33.

4) PARKING BRAKE SWITCH

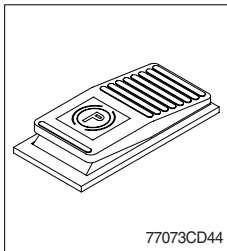

(1) This switch is pressed, the parking brake will start to operate and the gauge panel warning lamp will comes ON.

- ※ When operating the gear selector lever, be sure to release the parking brake. If the machine is operated with the parking brake engaged, the brake will overheat and may cause the brake system to go out of order.

5) MAIN LIGHT SWITCH

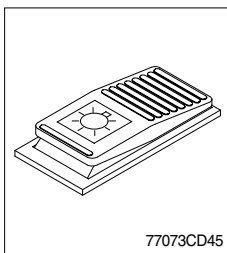

(1) This switch use to operates the clearance lamp and head light by two step.

- First step : Clearance lamp and cluster illumination lamp comes ON. Also, all indicator lamp of switches come ON.
- Second step : Head light comes ON.

6) WORK LAMP SWITCH

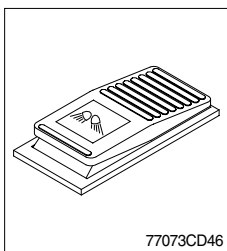

(1) This switch use to operates the front and rear work lamps by two step.

- First step : Front work lamp located on the cab comes ON.
- Second step : Rear work lamp located on the cab comes ON.

7) REAR WIPER AND WASHER SWITCH

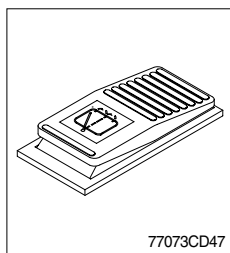

- (1) The switch use to operates the rear wiper and washer by two step.
- First step : The rear wiper operates.
 - Second step : The washer liquid is sprayed and the rear wiper is operated only while pressing. If release the switch, return to the first step position.

8) BUZZER STOP SWITCH

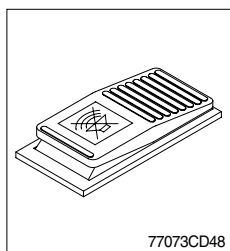

- (1) The red lamp on the cluster lights ON and the buzzer sounds when the machine has a problem.
In this case, if the switch is pressed, the buzzer will be stopped. Be sure to check machine for problems.
- (2) Wait until the lamp is turned OFF, if the red lamp lights ON after the buzzer stopped.
If not, stop engine and check the system which the lamp is ON.

9) AUTO SELECT SWITCH

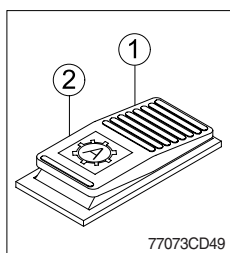

- (1) **Manual mode(①)**
Press the top of the switch for the manual mode of the autoshift function. The operator selects the desired speed and the desired direction in the manual mode with the gear selector lever.
- (2) **Automatic mode(②)**
Press the bottom of the switch for the autoshift function in the automatic mode. Press the bottom of the switch prior to shifting the transmission into forward or reverse in order to activate the autoshift function.
- ※ The operator can select two kinds of auto matic modes.
(1st ↔ 4th, 2nd ↔ 4th)
 - ※ When the switch failure occurs, it will be able to operate a auto select function from LCD.
 - ※ Refer to page 7-33.

10) BEACON SWITCH (Option)

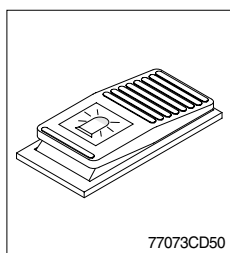

- (1) This switch turns ON the rotary light on the cab.

11) RIDE CONTROL SWITCH (Option)

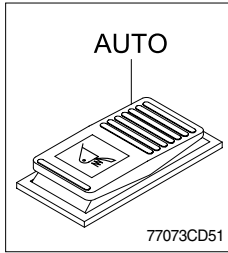

(1) AUTO position

Push in the top of the ride control switch in order to turn on the automatic ride control. The automatic ride control automatically turns on when the travel speed exceeds a preset speed of approximately 9.5km/h. The automatic ride control automatically shuts off during low speed 8km/h travel mode.

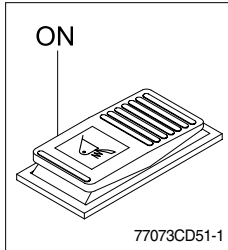

(2) ON position

Push in the bottom of the ride control switch in order to turn on the system for ride control regardless speed. The ride control will smooth the ride of the machine during travel.

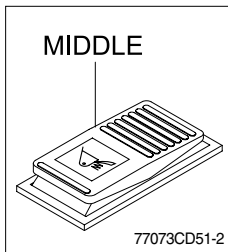

(3) MIDDLE position

Push the ride control switch to the middle position in order to turn off the system for the ride control.

12) HORN BUTTON

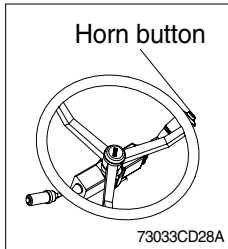

(1) If you press the button on the top of the multifunction switch, the horn will sound.

13) CAB LAMP SWITCH

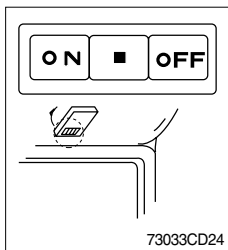

(1) This switch turns ON the cab room lamp.

14) KICK DOWN SWITCH

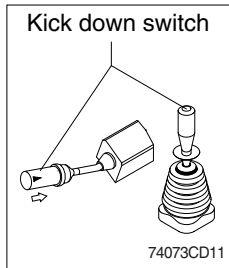

(1) Manual mode

It is effective 2nd speed to 1st speed only and recover to 2nd speed quickly when push the switch one more time.

(2) Automatic mode

① Mode 1(Down/Up)

It shifts down quickly from current gear to one step lower speed by pushing the switch and recover to original speed quickly when push the switch one more time.

② Mode 2(Down)

It shifts down from current gear to one step lower speed when push the switch everytime.

※ Refer to page 7-29,33.

15) MULTI FUNCTION SWITCH

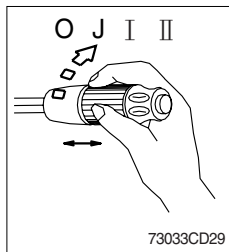

(1) Front wiper and washer switch

- ① When the switch is in J position, the wiper moves intermittently.
- ② When placed in I or II position, the wiper moves continuously.
- ③ If you push the grip of the lever, washer liquid will be sprayed and the wiper will be activated 2-3 times.

※ Check the quantity of washer liquid in the tank. If the level of the washer liquid is LOW, add the washer liquid (In cold, winter days) or water. The capacity of the tank is 1 liter.

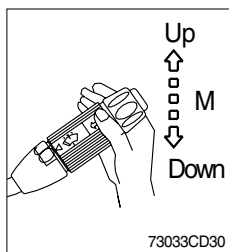

(2) Dimmer switch

- ① This switch is used to turn the head lights direction.
- ② Switch positions
 - Up : To flash for passing
 - Middle : Head lights low beam ON
 - Down : Head lights high beam ON
- ③ If you release the switch when it's in up position, the switch will return to middle.

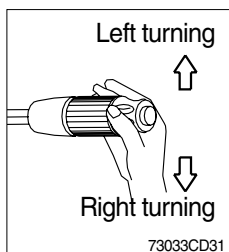

(3) Turning switch

- ① This switch is used to warn or signal the turning direction of the machine to other vehicles or equipment.
- ② Push the lever up for turning left, pull the lever down for turning right.