

GROUP 2 OPERATIONAL CHECKS AND TROUBLESHOOTING

1. OPERATIONAL CHECKS

This procedure is designed so the mechanic can make a quick check of the system using a minimum amount of diagnostic equipment. If you need additional information, read structure and function, Group 1.

A location will be required which is level and has adequate space to complete the checks.

The engine and all other major components must be at operating temperature for some checks.

Locate system check in the left column and read completely, following the sequence from left to right. Read each check completely before performing.



At the end of each check, if no problem is found (OK), that check is complete or an additional check is needed. If problem is indicated (NOT OK), you will be given repair required and group location.



If verification is needed, you will be given next best source of information:

- Chapter 2 : Troubleshooting
- Group 3 : Tests and adjustments

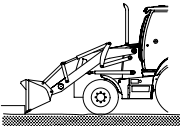
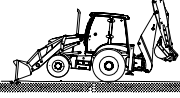
※ Hydraulic oil must be at operating temperature for these checks (refer to page 6-75).

Item	Description	Service action
<p>Hydraulic system warm-up procedure Run engine at high idle.</p>	<p>Hold a hydraulic function over relief to heat oil. (don't keep relief condition over 5 seconds at a time)</p> <p>Periodically cycle all hydraulic functions to distribute warm oil.</p> <p>Repeat procedure until oil is at operating temperature.</p> <p>FEEL : Hydraulic reservoir must be uncomfortable to hold your hand against. (approximately 40 ~50°C)</p>	<p>OK Check completed.</p>
<p>Hydraulic pump performance check Heat hydraulic oil to operating temperature. Run engine at high idle.</p>	<p>With bucket flat on ground, actuate boom raise. Time how long it takes to raise boom to full height.</p> <p>LOOK : Boom must raise to full height in less than 7 seconds.</p>	<p>OK Check completed.</p> <p>NOT OK Do priority valve (in pump) high pressure check at page 5-28.</p> <p>IF OK Do steering system leakage check at page 5-19.</p> <p>IF OK Do main hydraulic pump flow test at page 6-73.</p>
<p>Control valve lift check Run machine at low idle.</p>	 <p>With bucket partially dumped, lower boom to raise front of machine.</p> <p>Slowly move boom control lever (RCV lever) to boom lower position.</p> <p>Slowly move bucket control lever to bucket dump position.</p> <p>LOOK : Boom must not raise before moving down.</p> <p>Bucket must not rollback before dumping.</p>	<p>OK Check complete.</p> <p>NOT OK Repair lift checks in loader control valve.</p>

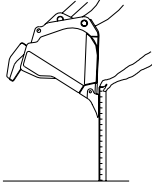
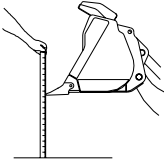
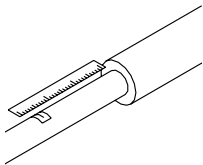
Item	Description	Service action
Bucket rollback circuit relief valve check	 <p>Position bucket at a 45° angle against an immovable object.</p> <p>Engage transmission in 3rd speed forward.</p> <p>LOOK : Bucket angle must not change.</p>	<p>OK Check complete.</p> <p>NOT OK Replace boom lower check valve.</p>
Bucket dump circuit relief valve low pressure check	 <p>Raise front of machine which bucket at 45° angle.</p> <p>Backdrag with bucket while observing bucket angle.</p> <p>LOOK : Bucket must not rollback</p>	<p>OK Go to next check.</p> <p>NOT OK Do loader system and circuit relief valve test at page 6-52.</p>
Pilot control valve float check Run engine at low idle.	 <p>With the bucket partially dumped, lower boom to raise front of machine.</p> <p>Push control lever to the float detent position and release lever.</p> <p>LOOK : Front of machine lower to the ground and valve must remain in float position when lever is released.</p>	<p>OK Check complete.</p> <p>NOT OK Do pilot control valve pressure test in group 3.</p>

Item	Description	Service action
<p>Boom cylinder leakage check</p> <p>Heat hydraulic oil to operating temperature.</p>	 <p>Dump bucket until teeth or cutting edge is perpendicular to the ground.</p> <p>Raise boom until cutting edge is about 1 m (3 ft) above ground.</p> <p>Stop engine. Measure drift from tooth or cutting edge to ground for 1 minute.</p> <p>Wait 10 minutes.</p> <p>Measure drift from tooth or cutting edge to ground for 1 minute.</p> <p>LOOK : Compare the drift rate between the first measurement and the second measurement.</p>	<p>OK</p> <p>Drift is approximately the same between first and second measurement.</p> <p>Repair loader control valve or circuit relief valve.</p> <p>NOT OK</p> <p>If drift is considerably less on second measurement, repair cylinder.</p>
<p>Bucket cylinder leakage check</p> <p>Heat hydraulic oil to operating temperature.</p>	 <p>Raise bucket about 1 m (3 ft) off ground with bucket level.</p> <p>Stop engine. Place a support under boom.</p> <p>Measure drift from tooth or cutting edge to ground for 1 minute.</p> <p>Wait 10 minutes.</p> <p>Measure drift from tooth or cutting edge to ground for 1 minute.</p> <p>LOOK : Compare the drift rates between the first measurement and the second measurement.</p>	<p>OK</p> <p>Drift is approximately the same between first and second measurement.</p> <p>Repair loader control valve or circuit relief valve at page 6-53.</p> <p>NOT OK</p> <p>Drift is considerably less on second measurement.</p> <p>Repair cylinder.</p>
<p>Check valve of safety valve leakage check</p> <p>Heat hydraulic oil to operating temperature.</p>	 <p>Put bucket level and position about 1.2 m (4 ft) above ground.</p> <p>Place a piece of tape on cylinder rod at least 51 mm (2 in) from rod guide.</p> <p>Run engine at low idle in safety-release position.</p> <p>LOOK : Bucket must not drift up.</p>	<p>OK</p> <p>Check complete.</p> <p>NOT OK</p> <p>Check or replace safety valve.</p>
<p>Pilot control valve (RCV lever) check</p>	 <p>Stop engine. Turn key switch to OFF position.</p> <p>Move control lever to all positions and then release.</p> <p>LOOK : Lever must return to neutral when released from all positions.</p>	<p>OK</p> <p>Check completed.</p> <p>NOT OK</p> <p>Repair pilot control valve.</p>

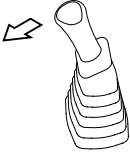
Item	Description	Service action
<p>Bucket leveler (positioner) check</p> <p>Run engine at low idle.</p>	 <p>Position bucket fully dumped just above ground level.</p> <p>Move control lever to bucket leveler detent position and release.</p> <p>LOOK : Bucket must rollback to the level position and control lever must return to neutral.</p> <p>If bucket is in a rolled back position when key is turned ON, control lever must be returned to neutral manually if placed in the bucket leveler detent position.</p> <p>After bucket is dumped once, bucket leveler will work normally.</p>	<p>OK Check complete.</p> <p>NOT OK Do bucket leveler checks.</p>

※ LOADER HYDRAULIC CYLINDER CYCLE TIME

1) MEASUREMENT CONDITION

- Coolant temperature : Inside operating range
- Steering position : Neutral
- Hydraulic temperature : 40~50°C
- Bucket : Unloaded
- Engine speed : High idling

2) MEASURING TOOL

- Stop watch (1EA)

3) MEASURING PROCEDURE

(1) Lifting time of boom

Set the bucket near the maximum tilt back position and at the lowest position on the ground. Raise the bucket and measure the time taken for bucket to reach the maximum height of the boom.

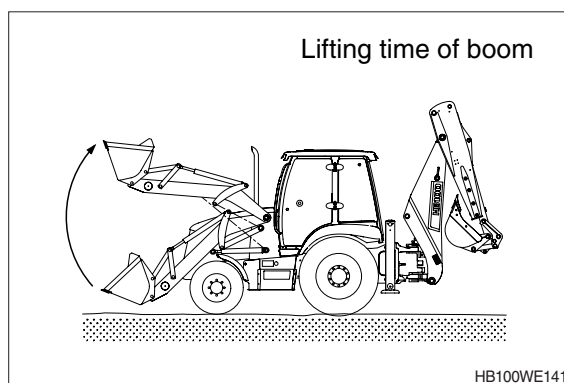

(2) Lowering time boom

Set the bucket horizontal with the boom at the maximum height, lower the bucket and measure the taken for the bucket to reach the lowest position on the ground.

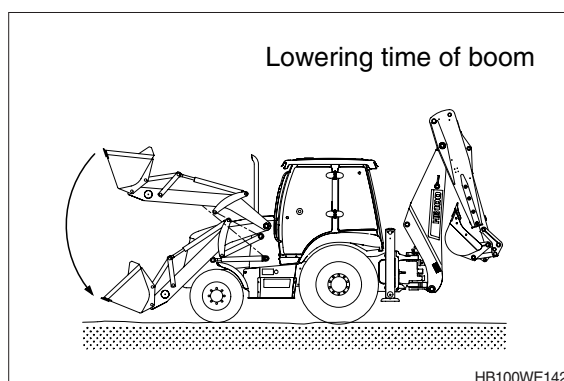

(3) Dumping time of bucket

Raise the boom to the maximum height and measure the time taken for the bucket to move from the maximum tilt back position to the maximum dump position

(4) Roll back time of bucket

Raise the boom to the maximum height and measure the time taken for the bucket to reach the maximum tilt back position.

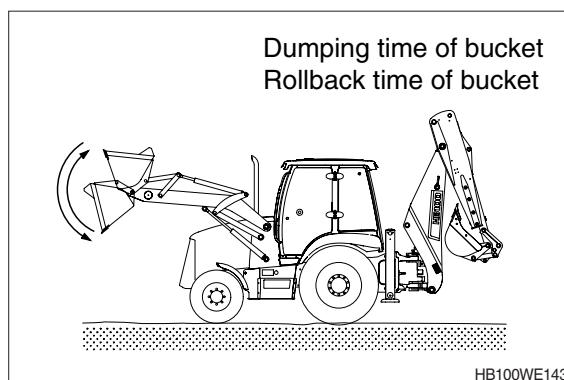

※ BACKHOE HYDRAULIC CYLINDER CYCLE TIME

- (1) Measure the cycle time of the boom, dipper and bucket cylinders.

(2) Preparation

- ① To measure the cycle time of the boom cylinders:

With the dipper rolled out and the empty bucket rolled out, lower the bucket to the ground, as shown.

- ② To measure the cycle time of the dipper cylinder.

With the empty bucket rolled in, position the dipper so that it is vertical to the ground. Lower the boom until the bucket is 0.5 m above the ground.

- ③ To measure the cycle time of the bucket cylinder.

The empty bucket should be positioned at midstroke between roll-in and roll-out, so that the sideplate edges are vertical to the ground.

- ④ Keep the hydraulic oil temperature at $45 \pm 5^\circ\text{C}$.

(3) Measurement

To measure cylinder cycle times.

- ① **Boom cylinders**

Measure the time it takes to raise the boom, and the time it takes to lower the boom. To do so, position the boom at one stroke end then move the control lever to the other stroke end as quickly as possible.

- ② **Dipper cylinder**

Measure the time it takes to roll in the dipper, and the time it takes to roll out the dipper. To do so, position the bucket at one stroke end, then move the control lever to the other stroke end as quickly as possible.

Boom cylinder

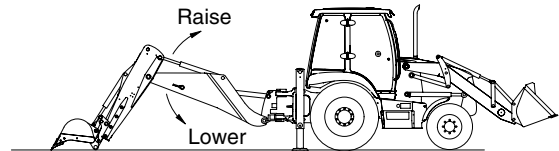

Dipper cylinder

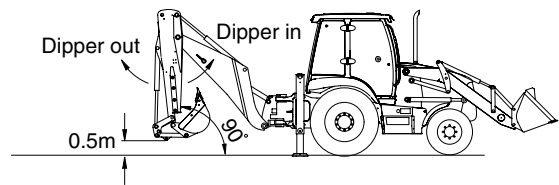

Bucket cylinder

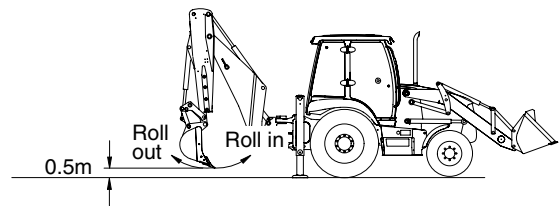

HB100WE146

③ **Bucket cylinders**

Measure the time it takes to roll in the bucket, and the time it takes to roll out the bucket. To do so, position the bucket at one stroke end, then move the control lever to the other stroke end as quickly as possible.

- Repeat each measurement 3 times and calculate the average values.

2. TROUBLESHOOTING

※ Diagnose malfunction charts are arranged from most probable and simplest to verify, to least likely, more difficult to verify. Remember the following steps when troubleshooting a problem :

Step 1. Operational check out procedure (see section 1)

Step 2. Operational checks (see group 2)

Step 3. Troubleshooting

Step 4. Tests and adjustments (see group 3)

Problem	Cause	Remedy
Noisy hydraulic pump	<p>Low oil supply or wrong viscosity.</p> <p>Plugged or pinched suction line.</p> <p>Air in oil.</p> <p>Loose or missing hydraulic line clamps.</p> <p>Hydraulic lines in contact with frame.</p> <p>Worn or damaged pump.</p>	<p>Fill reservoir with recommended oil.</p> <p>Clean or replace line.</p> <p>Check for foamy oil. Tighten connections.</p> <p>Replace O-rings and or lines.</p> <p>Tighten or replace clamps.</p> <p>Inspect and repair.</p> <p>Do hydraulic pump performance check in group 2. Do hydraulic pump flow test in group 3.</p>
No or Slow hydraulic functions	<p>Failed or worn hydraulic pump.</p> <p>Cold oil.</p> <p>Slow engine speed.</p> <p>Suction line air leak.</p> <p>Low oil supply.</p> <p>Wrong oil viscosity.</p> <p>Oil leaking past cylinders or control valve.</p> <p>Blocked or damaged line.</p> <p>Faulty or misadjusted pilot oil supply unit.</p> <p>Faulty pilot control valve (RCV).</p> <p>Binding main control valve spool.</p> <p>Faulty priority valve in pump.</p>	<p>Do performance check.</p> <p>Warm oil up.</p> <p>Adjust engine speed.</p> <p>Check high idle speed.</p> <p>Check for foamy oil.</p> <p>Add recommended oil.</p> <p>Use recommended oil.</p> <p>Check cylinder drift in group 2.</p> <p>Inspect lines.</p> <p>Do pilot oil supply unit pressure test in group 3.</p> <p>Do pilot control valve (RCV) pressure test in group 3.</p> <p>Inspect valve.</p> <p>Check priority valve specification.</p>

Problem	Cause	Remedy
No steering or hydraulic function	Low oil level. Failed hydraulic pump. Failed main hydraulic pump drive.	Add recommended oil. Remove and inspect return filter for metal pump particles. Remove main hydraulic pump and inspect drive gear.
No hydraulic functions steering normal	Failed hydraulic pump. Failed line filter. Faulty safety valve. Stuck open system and port relief valve. Faulty or misadjusted pilot supply unit.	Remove and inspect return filter for metal pump particles, or replace the pump. Remove and inspect line filter for RCV. Safety valve leakage test or ON, OFF function test. Replace relief valve. Do pilot supply unit pressure test in group 3.
Boom float function does not work	Low pilot control pressure. Faulty pilot control valve (RCV). Main control valve spool binding in bore.	Do pilot supply unit pressure test in group 3. Do pilot control valve pressure test. Do pressure reducing valve pressure test.
One hydraulic function does not work.	Faulty pilot control valve (RCV). Stuck open port relief valve. Oil leaking past cylinder packings. Blockage in oil lines or valve. Main control valve spool stuck in bore.	Do pilot control valve pressure test. Replace relief valve. Do boom and bucket cylinder leakage test in group 3. Inspect lines for damage. Disconnect and inspect lines for internal blockage. Inspect and repair valve.
Low hydraulic power	Leakage within work circuit. Low system relief valve (main relief valve) setting. Low port relief valve setting. Faulty or misadjusted pilot oil supply unit . Leaking system relief valve. Worn hydraulic pump. Faulty pilot control valve (RCV).	Do cylinder drift check in group 3. Do loader system and port relief valve pressure test in group 3. Do loader system and port relief valve pressure test in group 3. Do pilot oil supply unit pressure test in group 3. Remove and inspect valve. Do hydraulic pump performance check . Do pilot control valve(RCV) pressure test in group 3.

Problem	Cause	Remedy
Function drifts down	Leaking cylinders. Leaking seals in circuit relief valve (port relief valve) or valve stuck open. Leaking main control valve.	Do cylinder leakage checks in group 3. Inspect seals. Replace relief valve. Repair or replace valve section.
Boom drifts up	Leakage in boom down spool.	Remove and inspect boom down spool.
Boom down does not work (engine off)	Safety valve not operated. Stuck pilot control valve. Faulty line filter. Accumulation not operated. Main control valve spool stuck.	Operate valve. Inspect. Remove and inspect filter. Inspect. Inspect and repair valve.
Oil overheats	Low oil viscosity in hot weather. Excessive load. Holding hydraulic system over relief. Leakage in work circuit. Plugged fins in oil cooler. Internally plugged oil cooler. Incorrect system or circuit relief valve setting. Restriction in oil lines or main control valve. Pinched or restricted priority valve in pump LS line. Leaking system main relief valve. Worn hydraulic pump (internal leakage).	Use recommended oil. Reduce load. Reduce load. Do boom and bucket cylinder leakage test in group 3. Inspect and clean oil cooler. Do hydraulic oil cooler restriction test. Do loader system and circuit relief valve pressure test in group 3. Inspect for dented or kinked lines. Run engine at low idle. Steer machine back and forth. If engine load decreases while steering, a restricted LS line or priority valve malfunction is indicated. Do priority valve LS port flow test in group 3. Remove and inspect valve and seals. Do hydraulic pump performance check.
Function drops before raising when valve is activated	Stuck open lift check valve.	Do control valve lift check in group 2.

Problem	Cause	Remedy
Hydraulic oil foams	Low oil level. Wrong oil. Water in oil. Loose or faulty suction lines (air leak in system).	Add recommended oil. Change to recommended oil. Change oil. Tighten or install new lines.
Remote control valve (RCV) leaking	Leaking plunger seals.	Remove, inspect and replace plunger seals.

MAIN CONTROL VALVE (BACKHOE)

1) Abnormal operation of the actuators connected to the control block

Problem	Cause	Remedy
Lack of strength at all actuators	Main relief valve defective.	Take a pressure measurement. Replace main relief valve.
	Main relief valve out of adjustment.	Make necessary adjustments.
Lack of force on one actuator only	Port relief valve out of adjustment.	Reset to original pressure.
	Port relief valve blocked "open" (return to tank).	Replace port relief valve.
Movement performance slow	Hydraulic operator adjustable stop nut out of adjustment.	Make necessary adjustments.
	Individual compensator pressure blocked.	Replace housing + pressure compensator assembly.
Lack of load hold	Load hold check valve failure.	Replace housing + valve assembly
	Excessive clearance between the housing and the spool.	Replace housing + spool assembly
Simultaneous movement malfunction	Blockage of the individual compensator orifice.	Remove and clean individual compensator.
	Individual pressure compensator blocked.	Replace the housing + pressure compensator assembly.
	LS line leakage.	Replace LS flow regulator.

2) Abnormal machine operation

Problem	Cause	Remedy
Engine remains under load after spools are returned to neutral	Flow regulator blocked.	Replace flow regulator.
	Flow regulator filter clogged.	Replace the filter.

3) Abnormal control block operation

Problem	Cause	Remedy
Increase of force on controls or spool return defective	Control block assembly tie rods too tight. - A : 6.12 ± 0.61 kgf · m (44.3 ± 4.43 lbf · ft)	Check tightening torque (A). ※ Remove control block from its fixation points.

4) Visual defects

Problem	Cause	Remedy
Oil leakage at pressure relief valves and plugs	Seals defective.	Remove pressure relief valve or plug and replace seals.
Oil leakage between elements	Seals between elements defective.	Remove working sections and replace seals.
Oil leaking from hydraulic operator housing	Seal between housing and body defective.	Replace seal.
	Seal of adjustable stop nut defective.	Replace seal.